

Proceedings Book : 5th International Scientific Conference "Contemporary Kinesiology" : Split, August 28-30, 2015

Other document types / Ostale vrste dokumenata

Publication year / Godina izdavanja: **2015**

Permanent link / Trajna poveznica: <https://um.nsk.hr/um:nbn:hr:221:462550>

Rights / Prava: [In copyright](#)/[Zaštićeno autorskim pravom.](#)

Download date / Datum preuzimanja: **2024-10-06**



Repository / Repozitorij:

[Repository of Faculty of Kinesiology, University of Split](#)



5TH
INTERNATIONAL
SCIENTIFIC
CONFERENCE
MEĐUNARODNI
ZNAKSTVENI
KONGRES

CONTEMPORARY
KINESIOLOGY
SUVREMENA
KINEZILOGIJA

Split, August 28-30, 2015

PROCEEDINGS BOOK
ZBORNIK RADOVA



PROCEEDINGS BOOK
ZBORNİK RADOVA

5TH INTERNATIONAL SCIENTIFIC CONFERENCE „CONTEMPORARY KINESIOLOGY“
5. MEĐUNARODNI ZNANSTVENI KONGRES „SUVREMENA KINEZILOGIJA“

Publisher/Izdavač: Faculty of Kinesiology, University of Split, Croatia
Kineziološki fakultet, Sveučilište u Splitu, Hrvatska

**Graphic design/
Grafičko uređenje:** Dalmatina tisak, d.o.o.

Editors/Urednici: Zoran Grgantov
Saša Krstulović
Jelena Paušić
Tonči Bavčević
Dražen Čular
Ana Kezić
Alen Miletić

**Scientific committee/
Znanstveni odbor:** Slobodan Jarić, PhD, Delaware, USA
Nic James, PhD, London, UK
Raul Oliveira, PhD, Lisbon, Portugal
Sergej Ostojić, PhD, Belgrade, Serbia
Antonino Bianco, PhD, Palermo, Italy
Boštjan Šimunić, PhD, Koper, Slovenia
Jelena Obradović, PhD, Novi Sad, Serbia
Almir Atiković, PhD, Tuzla, Bosnia and Herzegovina
Lenče Aleksovska Veličkovska, PhD, Skopje, Macedonia
Daniela Šukova Stojanovska, PhD, Skopje, Macedonia
Husnija Kajmović, PhD, Sarajevo, Bosnia and Herzegovina
Izet Rađo, PhD, Sarajevo, Bosnia and Herzegovina
Saša Pantelić, PhD, Niš, Serbia
Dragan Mirkov, PhD, Belgrade, Serbia
Aleksandar Nedeljković, PhD, Belgrade, Serbia
Stevo Popović, PhD, Podgorica, Montenegro
Hrvoje Karninčić, PhD, Split, Croatia
Miodrag Spasić, PhD, Split, Croatia
Damir Sekulić, PhD, Split, Croatia
Nenad Rogulj, PhD, Split, Croatia

**Organizing committee/
Organizacijski odbor:** Rado Pišot, PhD, Koper, Slovenia
Ivan Prskalo, PhD, Zagreb, Croatia
Vujica Živković, PhD, Skopje, Macedonia
Dejan Madić, PhD, Novi Sad, Serbia
Milovan Bratić, PhD, Niš, Serbia
Goran Sporiš, PhD, Zagreb, Croatia
Vatroslav Horvat, PhD, Zagreb, Croatia
Siniša Kovač, PhD, Sarajevo, Bosnia and Herzegovina
Nusret Smajlović, PhD, Sarajevo, Bosnia and Herzegovina
Kemal Idrizović, PhD, Podgorica, Montenegro
Alen Kapidžić, PhD, Tuzla, Bosnia and Herzegovina
Mirjana Milić, PhD, Split, Croatia
Boris Milavić, PhD, Split, Croatia
Sunčica Delaš Kalinski, PhD, Split, Croatia

**In cooperation with/
U suradnji s:** University of Primorska, Koper, Slovenia
Faculty of Teachers Education, University of Zagreb, Croatia
ISSN 1847-0149

Autori su odgovorni za način i točnost referenciranja, i kvalitetu jezika.

PROCEEDINGS BOOK
ZBORNİK RADOVA

5TH
INTERNATIONAL
SCIENTIFIC
CONFERENCE

CONTEMPORARY KINESIOLOGY

5. MEĐUNARODNI ZNANSTVENI KONGRES „SUVREMENA KINEZILOGIJA“



Faculty of Kinesiology, University of Split, Croatia
Kineziološki fakultet, Sveučilište u Splitu, Hrvatska
Split, Croatia
August, 28-30, 2015

Contents/Sadržaj

INVITED LECTURES / POZVANA PREDAVANJA

Slobodan Jarić: Force and power producing properties of multi-joint muscular systems	11
Nic James: The evolving role of Performance Analysis in competitive sport	18
Sergej M. Ostojić: Ergogenic effects of guanidinoacetic acid	25
Raul Oliveira: Reeducation sensorimotor: from the research to clinical practice	28
Rado Pišot, Matej Plevnik: Learn to move – the role of fundamental motor patterns in child’s motor development	45

SECTION CONTEMPORARY SPORT ISSUES / SEKCIJA PROBLEMI SUVREMENOG SPORTA

Boštjan Šimunič: A new perspectives in muscle physiology (new knowledge and results from TMG studies)	65
Marino Krespi, Nedim Šišić, Sanja Milat: Ekspertna procjena važnosti funkcionalnih energetske mehanizama u rukometu	68
Marino Tavra, Goran Kuvačić, Saša Krstulović: Analiza razlika u rezultatima specijalnog judo fitnes testa kod judašica različite natjecateljske uspješnosti	75
Petra Đapić Caput, Saša Krstulović, Goran Kuvačić, Dragan Crnov, Marino Tavra: Povezanost motoričko-funkcionalnih sposobnosti i uspjeha u judu kod judaša kadetske dobne skupine – mišljenje judo eksperata	82
Goran Kuvačić, Petra Đapić Caput, Saša Krstulović: Utjecaj motoričko-funkcionalnih sposobnosti na uspjeh kod judaša kadetske dobne kategorije	89
Noemi Zovko, Alen Miletić, Vedrana Grčić: Povezanost dimenzija slike o sebi i ekstenziteta treninga u sportskom plesu	96
Safet Kapo, Nedim Čović, Izet Rađo, Husnija Kajmović, Nusret Smajlović, Siniša Kovač: Training effects on peak torque and total work of knee and elbow extensor and flexor muscle in female karate athletes	102
Joško Sindik, Vatroslav Horvat, Marijana Hraski, Damir Sertić: Application of the multidimensional inventory of sport excellence on the samples of young top female handball and volleyball players	112
Damir Zubac, Vladimir Ivančev, Hrvoje Karninčić: Association of hypohydration and rate of body mass reduction among elite youth amateur boxer	122

Alma Dizdar, Edin Mirvić, Faris Rašidagić: Utjecaj nekih motoričkih sposobnosti na vođenje lopte u vaterpolu	132
Tamara Đurković, Dejan Ilić, Goran Nešić, Danica Janičijević, Nikola Fišeković: Comparative analysis of foot status and certain motoric capabilities in female volleyball and handball players	142
Danijela Kuna, Sanjin Džajić, Josip Maleš: Hijerarhijska klasifikacija metodičkog modela za poduku skijaškog pluznog zavoja i pluznog luka	149
Mersad Čuljević, Danijela Kuna: Efekti različitih modela treninga na rezultatsku uspješnost u alpskom skijanju	159
Mila Vukadinović, Milan Pantović, Jelena Obradović: Uticaj vežbi snage uz proteinsku suplementaciju na telesni sastav	168
Aleksandra Aleksić-Veljković, Dejan Madić, Katarina Herodek, Mila Vukadinović: Age-group differences in vertical jump performance of young female gymnasts	176
Saša Pišot: Running and serious leisure perspective	184
Nikola Toplica Stojanović, Zvezdan Savić, Nebojša Randelović: A comparative analysis of the jumping tempo of volleyball players at different levels of competition	192
Dražen Čular, Igor Jelaska, Domagoj Pečko: Population size as a factor in countries' success in WTF taekwondo competitions	203
Dino Belošević, Petra Mandić Jelaska, Antonio Perić: Analysis of attitudes towards combat sports	212
Hrvoje Sivrić, Marko Erceg, Vujica Živković, Luka Pezelj: The differences in the selected indicators of the situational effectiveness between the A league Champions and the other clubs participating in UEFA Champions League 2014/15	221
Ensar Abazović, Erol Kovačević, Marko Erceg, Elvir Zametica: Funkcionalni profil mladih košarkaša	229
Milan Čoh, Milan Žvan, Stanislav Peharec, Petar Bačić: Differences between the elite and sub-elite athletes in kinematic and dynamic parameters of sprint - start	237
Renata Pavić, Pero Kuterovac: Utjecaj antropometrijskih karakteristika na uspješnost plivanja kraul tehnikom kod vrhunskih hrvatskih plivača	243
Marko Vidnjević: Kinesiology interventions during the contest period in football club koper	252

Željko Krneta, Sunčica Poček: Analysis of the predictive value of basic motor tests for young female volleyball players	260
Valdemar Štajer, Milan Vučinić, Aleksandar Karać, Aleksandar Kotrljanović, Mario Roška: Uticaj vežbi snage-tipa izdržljivosti i vežbi za razvoj skočnosti na agilnost kod mladih odbojkaša	267
Šime Buzov, Alen Gavrančić, Petra Mandić Jelaska: The impact of a programmed football training on functional abilities among young players.....	273
Boris Milavić, Boris Maleš, Dražen Guć: Konstrukcija i inicijalna validacija upitnika plivačke kompetencije i angažiranosti.....	283
Goran Sporiš, Nebojša Trajković, Damir Jurko: Effects of off-season sand training on physical performance in adolescent indoor volleyball players....	292
Andreja Ivas, Dražen Čular, Stipe Blažević: Utjecaj veličine populacije na rezultatsku uspješnost država na svjetskim taekwondo prvenstvima ITF načinom...	304
Goran Mickoski, Stipe Blazević, Žarko Kostovski: Influence of certain motor skills on the execution of judo throwing technique morote seoi nage.....	318
Mirjana Milić, Zoran Grgantov, Marjeta Mišigoj Duraković, Goran Nešić, Johnny Padulo: Razlike u kronološkoj, biološkoj i trenažnoj dobi uspješnijih i manje uspješnih mladih odbojkaša	328
Tea Bešlija, Mario Tomljanović, Ana Kezić, Jakov Previšić: Yo-yo test kao prediktor uspješnosti rukometaša	337

**SESSION PHYSICAL ACTIVITY FOR HEALTH /
SEKCIJA KINEZIOLŠKA AKTIVNOST ZA ZDRAVLJE**

Antonino Bianco: The protein supplements consumption among people attending commercial gyms: the Protein Project.....	345
Lovro Štefan, Goran Sporiš, Dražen Čular, Damir Jurko: Organism adaptations on high altitude training	348
Elvira Nikšić, Indira Mahmutović, Faris Rašidagić: Representation of postural disorders of the lower extremities with students of classroom teaching with regard to the gender.....	357
Saša Pantelić, Zoran Milanović, Radmila Kostić, Slavoljub Uzunović, Milovan Bratić, Saša Veličković, Tomislav Okičić, Nenad Stojiljković: The connection between body composition and fitness performance among elderly men.....	371
Slavoljub Uzunović, Goran Zdravković, Radmila Kostić, Saša Pantelić, Zoran Milanović, Bojan Jorgić, Marko Aleksandrović: A comparison of the static balance of children with and without visual impairment.....	380

Damir Bešić, Vlado Balaban: Differences between various household income backgrounds in relation to objective measured physical activity in Czech elementary school-aged children	388
Mihaela Jurdana, Ana Petelin, Zala Jenko Pražnikar: Serum visfatin levels and physical fitness in normal and overweight subject	395
Nikola Jevtić, Dragan Marinković, Dejan Javorac, Saša Semeredi, Borislav Obradović: Ima li razlike u izometrijskoj izdržljivosti lumbalnih ekstenzora kod predadolescenata	404
Olivera Knežević, Marko Kadija, Darko Milovanović, Suzana Blesić, Dragana Drljačić, Dragan Mirkov: Differences in neuromuscular function between athletes with and without ACL re-injury – a retrospective preliminary research	411
Branka Protić - Gava, Mario Roška, Tijana Šćepanović: Razlike u posturalnom statusu kolena devojčica uzrasta od 4 do 13 godina	418
Darinka Korovljev, Dragan Marinković, Mario Roška, Dejan Madić: Posturalni status kičmenog stuba kod dečaka uzrasta od 4-13 godina	425
Tijana Šćepanović, Dragan Marinković, Darinka Korovljev, Dejan Madić: Status kičmenog stuba u sagitalnoj ravni kod devojčica	435
Danuta Grzesiak-Witek, Paweł Witek: Method of Educational Kinesiology in the therapy of people with aphasic speech disorder – possibilities and limitations	442
Siniša Kovač, Denis Čaušević, Zana Bujak, Boris Metikoš: Analiza različitosti statusa posture kod djece iz ruralnih i urbanih sredina	452
Maha Sellami, Abderraouf Ben Abderrahaman, Safa Shili, Hanen Djemail, Wiem Keksi, Hassane Zouhal: Effect of combined training (strength and sprint) and advanced age on somatroph hormones in response to supramaximal exercise	461
Nika Stanović, Zoran Grgantov, Jelena Agić, Barbara Gilić: Učestalost i topologija boli kod mladih odbojkašica	465
Karla Magzan, Zoran Grgantov, Maja Gelo, Ljubomir Pavlović: Učestalost i topologija boli kod mladih odbojkašica i rukometašica	473
Jerko Cvitanić, Mia Perić, Dragana Olujić: Relacije socio-demografskih karakteristika i razloga za vježbanje polaznica zumba fitness programa	481
Sanja Vitaić, Marko Erceg, Mirjana Milić: Razlike u parametrima ventilacijske funkcije pluća mladih odbojkašica prema kriteriju natjecateljske uspješnosti	487
Biljana Kuzmanić, Ensar Abazović, Jelena Paušić: Utjecaj intraabdominalnog pritiska (IAP) na izvođenje testa fleksije u zglobu kuka u sjedećem položaju	497

**SESSION TRENDS IN PHYSICAL EDUCATION /
SEKCIJA TRENDOVI U TJELESNOJ I ZDRAVSTVENOJ KULTURI**

Tonči Bavčević: Interpersonal communication in education - kinesiological perspective	508
Ana Penjak, Hrvoje Karninčić: Rodna jednakost ili različitost na fotografijama hrvatskog sportskog časopisa «Sportske Novosti»	519
Faris Rašidagić, Edin Mirvić, Elvira Nikšić: Razlika u aktivnost na času sporta i tjelesnog odgoja	526
Dorjana Zerbo Šporin: To body fat related anthropometry for female students with different physical activity attitudes	534
Marko Badrić, Kristina Ravlić: Razlike u funkcionalnim sposobnostima učenika prema stupnju uhranjenosti	540
Edin Mirvić, Faris Rašidagić, Alma Dizdar: Efekti 24-satnog programa obuke neplivača na učenje osnovnih elemenata u plivanju	548
Lidija Vlahović, Bojan Babin, Josip Babin: Povezanost motoričkih sposobnosti i nastavne teme stoj na rukama uz okomitu plohu kod jedanestogodišnjih učenica	558
Ivan Prskalo, Marko Badrić, Sanja Bogovčić: Razlike u motoričkim sposobnostima kod učenika primarnog obrazovanja prema postotku masnog tkiva u tijelu	566
Vedrana Sember, Shawnda A. Morrison: The effects of physical activity on academic performance and physical fitness in elementary school girls	576
Matea Malada, Sunčica Delaš Kalinski, Lenče Aleskovska-Veličkovska, Nevenka Maras: Razina usvojenosti dvaju programa sportske gimnastike od strane studentica	579
Igor Jelaska: Random number generator comparisons of effect size measures in one-way repeated measures ANOVA	585
Miodrag Spasić, Karlo Gašpar, Antonio Perić: Morfološki i motorički prediktori agilnosti kod dječaka	595
Mateja Kunješić, Marijana Hraski, Edita Skaramuca, Ivan Prskalo: Usporedba antropološkog statusa učenika iz Zagreba i Dubrovnika	601
Antonio Perić, Dino Belošević, Tanja Mandić: Spol i kronološka dob kao prediktori statusa motoričkog razvoja kod školske djece	609
Barbara Kaličanin, Dora Marić, Ana Petrović: Utvrđivanje povezanosti između različitih manifestacija reaktivne agilnosti	619
Karla Šitić, Goran Gabrilo, Mia Perić: Postoje li razlike u plivačkoj izvedbi između dviju grupa studenata kod provođenja identičnog plivačkog programa kroz dva različita vremenska perioda?	627
Marija Lorgjer, Kristina Kos, Ivan Prskalo: Vrednovanje rada u nastavi tjelesne i zdravstvene kulture u primarnoj edukaciji	636

Goran Nešić, Nikola Majstorović: Differences in anthropometric characteristics and general motor abilities between female volleyball players and untrained girls 17 years old	644
Luka Pezelj, Boris Milavić, Toni Gamulin, Petra Sinovčić, Zorana Šesnić: Relacije između kineziološke angažiranosti, psiholoških obilježja i tipova korištenja televizije adolescenata	653
Petra Sinovčić, Mirjana Milić, Sunčica Delaš Kalinski: Relacije sedentarnih ponašanja i kineziološkog aktiviteta adolescenata.	664
Melis Mladineo Brničević, Daša Duplančić, Josefina Jukić, Siniša Zagorac: Sastav tijela kod različito kineziološki angažiranih studentica	677
Hugo Guelet, Mario Pujol, Ana Penjak: Going retro with the Indians: or do the native american sports mascots endanger the american society?	686
Vujica Zivkovic, Seryozha Gontarev, Kalac Ruzdija: Factors associated with physical activity in a sample of Macedonian students of Ss. Cyril and Methodius University	694
Damir Bavčević, Đurđica Miletić: Redefining of criteria of the test for estimation of motor knowledge	710
Barbara Gilić, Boris Milavić, Veronika Jurčić, Lucija Maglica, Ante Županović: Razlike između adolescenata koji odustaju ili ustraju u bavljenju organiziranom kineziološkom aktivnošću	718
Tonči Bavčević: Research review of relation of visual-motor integration, motor abilities and ontogenetic development	729
Ana Kezić, Nina Ivančić, Mia Mandić: Ambidekstrijka kao prediktor uspješnosti u ritmičkoj gimnastici kod studenata	738
Tonči Bavčević, Damir Bavčević: Construction and validation of the test for evaluation of visual-motor integration in children aged 7 to 10	743
Teo Bavčević, Tonči Bavčević, Damir Bavčević: Preliminary research results of visual-motor integration in children aged 7 to 10	751
Nevenka Maras, Sunčica Delaš Kalinski, Hrvoje Sivrić, Damir Jurko, Mihaela Pavlović: Učiteljica - subjekt u nastavi Tjelesne i zdravstvene kulture u razrednoj nastavi	759
Vildane Jasari, Josko Milenkovski, Abedin Ibrahim, Stipe Blažević, Žarko Kostovski: Structure of the anthropometric characteristics with female students dealing with volleyball.	768
Petra Dolenc: Slovenian version of the goal orientations in exercise measure: a preliminary study with young athletes	776



INVITED LECTURES
POZVANA PREDAVANJA

Force and power producing properties of multi-joint muscular systems

Slobodan Jarić

*Department of Kinesiology and Applied Physiology & Biomechanics and
Movement Science Graduate Program, University of Delaware, USA*

Abstract

Routine test batteries aimed to assess muscle mechanical properties are typically based on exertion of maximum force in single joint movements, as well as on more complex movements that often lack either ecological or external validity. However, recent studies have suggested that functional multi-joint movements (e.g., jumping, pushing, cycling, lifting) could be also used to selectively reveal important the muscular mechanical properties, such as their ability to exert high level of force (F) and power (P) output, or to achieve high movement velocity (V). Specifically, our resent research revealed that manipulation of external load provides a range of F and V data that could be modeled by linear regression. The parameters of that F-V regression equation may not be only highly reliable and at least moderately valid, but also allow for calculation of a relatively simple parabolic P-V relationship of the tested muscles. Therefore, the loaded functional multi-joint movements could reveal important aspects of the design and function of the human neuro-musculo-skeletal system. Moreover, the same movements could also be developed into routine tests of F, V, and P exerting capacities of the tested muscles.

Key Words: force-velocity; power-velocity; load; test; parameters;

Introduction

Evaluation of the abilities of muscular system to maximize force, power, and velocity output has been in focus of both researchers and practitioners for decades. Seminal studies conducted on both isolated animal muscles (Hill 1938; Fenn and Marsh 1935) and human single-joint movements (Wilkie 1950) revealed a well-known hyperbolic force–velocity (F–V) relationship (see left

hand panel of Fig. 1 for illustration). Since power (P) represents a product of F and V , F - V relationship directly determines the pattern of P - V relationship that is inevitably complex in shape and partly skewed towards lower velocities (see the corresponding dashed line). The above described shapes of the F - V and P - V relationships have been consistently presented in various textbook materials on muscle mechanics and modeling, as well as presumed in analyses of outcomes of various routine tests of physical abilities.

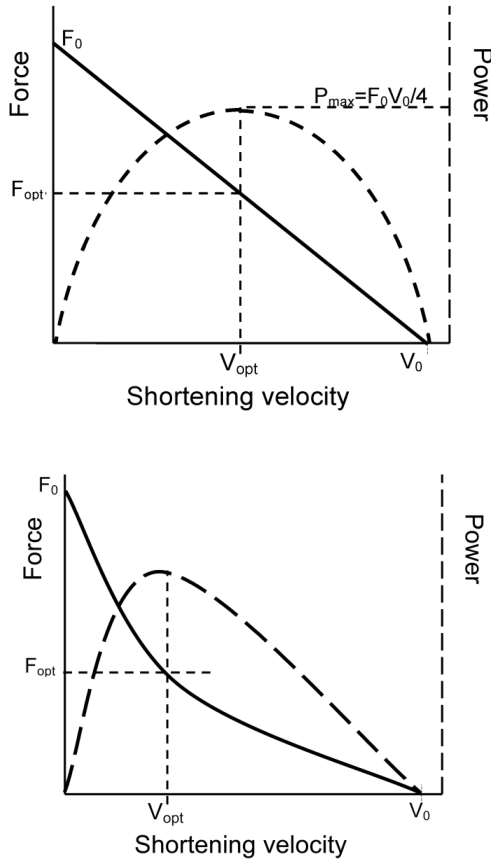

Figure 1. Left hand panel shows classical F - V (solid line) and the corresponding P - V (dashed line) relationship typically obtained from *in vitro* muscles and voluntary contractions of single muscle groups. Right hand panel show the same relationships obtained from loaded functional multi-joint tasks. F_{opt} denote to the muscle F that overcomes the optimum external load that results in the optimum shortening V_{opt} for maximizing P .

Force-velocity properties of functional multi-joint movements

While the F-V relationship of individual muscles and muscle groups tends to be non-linear, some early studies performed on maximum performance multi-joint tasks have suggested that the relationship between the F output and V of observed from functional multi-joint movements could be approximately linear (Vandewalle et al. 1987). More recent studies also revealed relatively strong and fairly linear F-V relationships observed from relatively narrow intervals of F and V data. Such data have been obtained from various vertical jumps (Cuk et al. 2014; Sheppard et al. 2008), simultaneous leg extensions where leg muscles act through closed kinetic chains (Samozino et al. 2012, 2014), and various arm and upper body movements (Hintzy et al. 2003; Sprague et al. 2007; Sreckovic et al. 2015). Typically, an external load was manipulated of to provide ranges of F and V data that allowed for applying a linear regression model

$$F(V) = F_0 - aV , \quad (\text{eq.1})$$

Note that F_0 is F-intercept represents the maximum isometric F (i.e., 'muscle strength'), while a is the slope that corresponds to F_0/V_0 , where V_0 is the V-intercept (theoretically, the 'maximum movement velocity'; see right hand panel of Fig. 1 for illustration). Since the P output represents a product of F and V, the linear F-V relationship (eq.1) gives a relatively simple parabolic P-V relationship

$$P(V) = F(V) V = F_0 V - a V^2 , \quad (\text{eq. 2})$$

Here the maximum P (P_{max}) corresponds to maximum power of the tested muscles

$$P_{max} = (F_0 V_0)/4 , \quad (\text{eq. 3})$$

that should be observed at 50% of both at the muscle strength and maximum velocity (Sprague et al. 2007; Cuk et al. 2014; Suzovic et al. 2013; Jaric and Markovic 2013). Therefore, the shape of both the F-V and P-V relationship of the tested muscles is determined by numerical values of 3 mutually dependent parameters (i.e., F_0 , V_0 , and P_{max}) that have apparent physiological meaning representing muscle strength, maximum movement velocity, and the maximum power output, respectively (see Figure 1 for illustration).

Reliability, validity, and sensitivity of force-velocity parameters

To justify the use the linear model of the F-V relationship obtained from loaded functional movements for the purpose of the assessment of muscle properties, of essential importance are the properties of their parameters. Although we know that direct assessments of F, P, and V values from various functional movements, such as the cycling and vertical jumps, could be both highly reliable and sufficiently valid (Sheppard et al. 2008; Bozic et al. 2012), only our 2 recent studies evaluated the reliability of F-V relationship parameters (Sreckovic et al. 2015; Cuk et al. 2014). Most of the parameters revealed high reliability across various types of vertical jumps and bench press throws (i.e., all ICC > 0.80), while F_0 and P_{max} could be somewhat more reliable than V_0 .

Regarding the sensitivity of the F-V parameters (i.e., F_0 , V_0 , and P_{max}), the differences in both P_{max} and F-V relationship slope between either the individuals of different fitness levels (Vandewalle et al. 1987), or young and old women (Yamauchi et al. 2009), or elite and sub-elite karate competitors (Ravier et al. 2004) appear to predominantly originate from differences in F_0 rather than V_0 (note that $a=F_0/V_0$). Conversely, individuals of different P_{max} could also differ more regarding V_0 than F_0 when performing wheelchair propulsions (Hintzy et al. 2003), while the differences in P between young male and female swimmers could be based on comparable differences in both F_0 and V_0 (Nikolaidis 2012). Note that all above cited studies have been based on cross-sectional design, while no studies yet have assessed and compared the sensitivity of F-V relationship parameters for detecting outcomes of various athletic training or rehabilitation interventions. Figure 3 depicts the differences in F-V relationships observed from strength trained, physically active, and sedentary individuals (Cuk et al, submitted). Apparently, the strength trained and sedentary individuals reveal the highest and lowest P, respectively, while the differences among the tested groups could originate more from the differences in F_0 than in V_0 . These results suggest that the applied linear F-V model could be sensitive enough to discern among the muscular properties of individuals of different physical abilities even when obtained from relatively narrow ranges of F and V data.

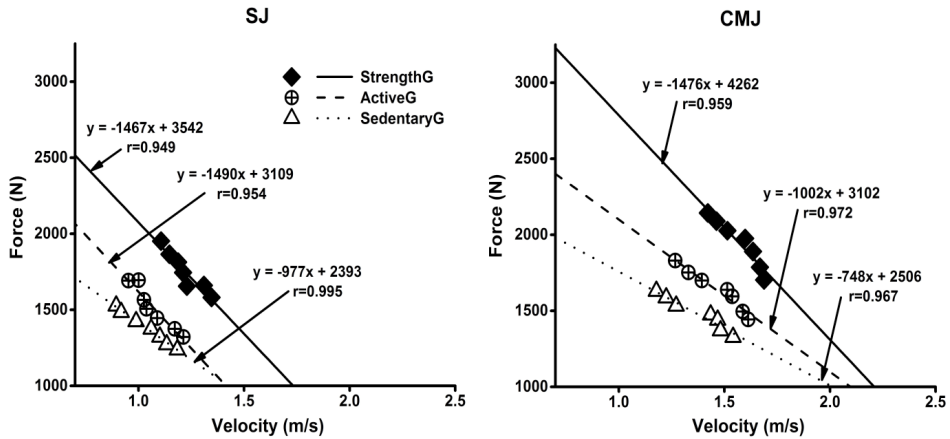

Figure 2. Example of F-V relationship obtained from series of squat jumps (SJ; left hand panel) and countermovement jumps (CMJ; right hand panel) loaded and unloaded by approximately constant external force (range from +30% to -30% of body weight; Cuk et al, submitted). The data are averaged across groups body builders (StrengthG), physically active (ActiveG), and sedentary subjects (SedentaryG). Note exceptionally strong and linear F-V relationship, as well as that the tested groups differ more regarding maximum F than maximum V.

Regarding the concurrent validity of its parameters, the findings have been partly inconclusive. For example, the concurrent validity of F_0 with respect to directly measured muscle strength could be from moderate-to-high (Cuk et al. 2014; Vandewalle et al. 1987; Sreckovic et al. 2015) to low and partly insignificant (Ravier et al. 2004; Yamauchi and Ishii 2007). The concurrent validity of V_0 could be either low (Cuk et al. 2014) or moderate (Yamauchi and Ishii 2007). Conversely, the concurrent validity of P_{max} could be particularly high when obtained from the range of external loads close to the optimum load (Cuk et al. 2014; Sreckovic et al. 2015). Finally, some studies found that the concurrent validity could be higher in P_{max} and V_0 than in F_0 (Ravier et al. 2004; Yamauchi and Ishii 2007).

Conclusions

To conclude, there is strong evidence that the F-V relationship of a variety of maximum performance multi-joint tasks could be fairly linear. Among the consequences is a parabolic P-V relationship that reveals the optimum loads at

one-half of maximum F and V. Therefore, the important mechanical properties of the muscles acting in complex functional movement tasks could be described by simpler models than the same properties obtained from actions of either isolated muscles or individual muscle groups. Moreover, the important mechanical parameters obtained from such relationships could be sufficiently reliable, valid, and sensitive to justify the use of linear F-V model in both research and routine testing. Therefore, in addition to their theoretical implications, loaded maximum performance multi-joint tasks (e.g., vertical jumping, cycling, throwing, lifting etc) could be developed into relatively simple and ecologically valid routine tests of F, V and P producing capacities of the tested muscles.

Acknowledgments

The study was supported in part by NIH grant (R21AR06065) and a grant from the Serbian Research Council (#175037).

References

Bozic PR, Pazin N, Berjan B, Jaric S (2012) Evaluation of alternating consecutive maximum contractions as an alternative test of neuromuscular function. *Eur J Appl Physiol* 112 (4):1445-1456.

Cuk I, Markovic M, Nedeljkovic A, Ugarkovic D, Kukolj M, Jaric S (2014) Force-velocity relationship of leg extensors obtained from loaded and unloaded vertical jumps. *Eur J Appl Physiol* 114 (8):1703-1714.

Fenn WO, Marsh BS (1935) Muscular force at different speeds of shortening. *J Physiol* 85:277-297.

Hill AV (1938) The Heat of Shortening and the Dynamic Constants of Muscle. *Proc Roy Soc (Lond)* 126 (843):136-195.

Hintzy F, Tordi N, Predine E, Rouillon JD, Belli A (2003) Force-velocity characteristics of upper limb extension during maximal wheelchair sprinting performed by healthy able-bodied females. *J Sports Sci* 21 (11):921-926.

Jaric S, Markovic G (2013) Body mass maximizes power output in human jumping: a strength-independent optimum loading behavior. *Eur J Appl Physiol* 113 (12):2913-2923.

Nikolaidis PT (2012) Age- and sex-related differences in force-velocity characteristics of upper and lower limbs of competitive adolescent swimmers. *J Hum Kinet* 32:87-95.

Ravier G, Grappe F, Rouillon JD (2004) Application of force-velocity cycle ergometer test and vertical jump tests in the functional assessment of karate competitor. *J Sports Med Phys Fitness* 44 (4):349-355.

Samozino P, Rejc E, Di Prampero PE, Belli A, Morin JB (2012) Optimal force-velocity profile in ballistic movements--altius: citius or fortius? *Med Sci Sports Exerc* 44 (2):313-322.

Samozino P, Rejc E, di Prampero PE, Belli A, Morin JB (2014) Force-velocity properties' contribution to bilateral deficit during ballistic push-off. *Med Sci Sports Exerc* 46 (1):107-114.

Sheppard JM, Cormack S, Taylor KL, McGuigan MR, Newton RU (2008) Assessing the force-velocity characteristics of the leg extensors in well-trained athletes: the incremental load power profile. *J Strength Cond Res* 22 (4):1320-1326.

Sprague RCt, Martin JC, Davidson CJ, Farrar RP (2007) Force-velocity and power-velocity relationships during maximal short-term rowing ergometry. *Med Sci Sports Exerc* 39 (2):358-364.

Sreckovic S, Cukl, Djuric S, Nedeljkovic A, Mirkov D, Jaric S (2015) Evaluation of force-velocity and power-velocity relationship of arm muscles. *Eur J Appl Physiol*.

Suzovic D, Markovic G, Pasic M, Jaric S (2013) Optimum load in various vertical jumps support the maximum dynamic output hypothesis. *Int J Sports Med* 34 (11):1007-1014.

Vandewalle H, Peres G, Heller J, Panel J, Monod H (1987) Force-velocity relationship and maximal power on a cycle ergometer. Correlation with the height of a vertical jump. *Eur J Appl Physiol* 56 (6):650-656.

Wilkie DR (1950) The relationship between force and velocity in human muscle. *J Physiol* 110:249-280.

Yamauchi J, Ishii N (2007) Relations between force-velocity characteristics of the knee-hip extension movement and vertical jump performance. *J Strength Cond Res* 21 (3):703-709.

Yamauchi J, Mishima C, Nakayama S, Ishii N (2009) Force-velocity, force-power relationships of bilateral and unilateral leg multi-joint movements in young and elderly women. *J Biomech* 42 (13):2151-2157.

The evolving role of Performance Analysis in competitive sport

Nic James

Middlesex University, London, UK

Introduction

Sports Performance Analysis (SPA) is concerned with understanding human performance during a sporting event. Performance Analysts will therefore measure and record the actions (notational analysis) and movements of players with a view to describing the events either during or after the match has finished. Varying degrees of complexity and precision are possible with technology playing a major role in how Performance Analysis is developing. This paper will describe how Performance Analysis has evolved from a predominately academic area within Sports Science into an applied discipline that services most major sports.

Academic roots of Performance Analysis

The history of Performance Analysis is long, very early examples include the notation of dance (Laban, 1948), baseball (Fullerton, 1912) and basketball (Messersmith and Corey, 1931). However, in the UK and Europe, probably the most influential and certainly the most controversial notational analyst was Charles Reep, who died in 2002 (Pollard, 2002) having devoted over 50 years to analysing football (and other sports) in great detail. Whilst most of his work remains unpublished his legacy remains as the primary advocate of the long-ball game or direct play. His first published paper produced the finding that the structure of soccer was determined by near constants (Reep and Benjamin, 1968) and his work is thought to have influenced many researchers and football coaches e.g. Charles Hughes, who was the Assistant Director of Coaching for the Football Association (Hughes, 1987); Stan Cullis, manager of Wolverhampton Wanderers and Graham Taylor, manager of Lincoln City, Watford, Aston Villa, England and Wolverhampton Wanderers) to adopt playing strategies based on his findings.

In the mid-1970s Liverpool Polytechnic started the first sports degree independent of Physical Education. Some of their researchers had dramatic impacts on the future of Performance Analysis as a discipline within its own right. Reilly and Thomas(1976) coded football players' movements into standing, walking, trotting, running and sprinting categories. This relatively simple analysis had profound consequences as football coaches were able to match training schedules to actual match demands for the first time. Similarly, Sanderson and Way (1977) adapted Jake Downey's (1973) notation system for tennis to pioneer analysis of squash. This was important as Mike Hughes, a new colleague at Liverpool Polytechnic (1981) and squash coach became fascinated at the possibilities of this approach. Mike consequently developed undergraduate academic courses and, along with a multitude of students, notation systems for a wide range of sports. Whilst much of this work was unpublished, or published within proceedings of conferences, the impact of Mike's work was profound. He continued to develop academic courses and saw their popularity increase exponentially. He also approached sports teams and National Governing Bodies to provide notational analysis support, something almost unheard of in the 1980s. As a consequence of the success of these ventures he decided to promote Performance Analysis, most notably notational analysis, by instigating the International Society of Performance Analysis of Sport in 1992 (formerly known as the International Society of Notational Analysis) and later the International Journal of Performance Analysis in Sport in 2001. By founding these two important outlets for academic work in Performance Analysis Mike led the rapid growth in this area. His influence today reaches across the world and the large expansion of academics in this area has seen a similar rise in publications, both textbooks and research papers published in a wide range of high impact International journals.

Some notable Performance Analysis papers published in SCI journals

A comprehensive selection of papers is not possible in this short section so papers that have pioneered developments in technique or understanding are presented chronologically and within themes. The first paper in the first edition of the International Journal of Performance Analysis in Sport was an attempt to construct a methodology for profiling sports performance (Hughes, Evans, and Wells, 2001). The authors presented a technique to determine the number of matches required to present a level of performance suggested to be representative of typical performance, dependent upon the typical variability

of the performance between matches. This paper led to much debate into the area of performance profiling and the extent to which performance can be considered predictable in the future. Alternative methods were presented for tennis (O'Donoghue, 2005) and rugby (James et al., 2005) and recently critically reviewed (Butterworth et al., 2013).

Hughes and Bartlett (2002) presented their ideas on performance indicators in sport. The paper is currently the 7th most read paper in the Journal of Sports Sciences (20th July 2015) and has been cited 481 times (Google Scholar). This paper advises on the handling of performance data and the need to contextualise this information so as not to make incorrect inferences based on incomplete information.

Hughes and Franks (2005) analysed the football World Cups of 1990 and 1994 to investigate the suggestions of Reep and Benjamin (1968) that about 80% of goals come from possessions that have 3 passes or less and that goals are scored from every 10 shots. Their results confirmed these assertions but by normalising the data with respect to the respective lengths of passing frequency they showed that the simplistic view that the "long ball game" or "direct play" approach was advantageous was flawed.

An emerging theme in Performance analysis has been the effect of independent variables. For example Jones et al. (2004) found that the duration of possession was related to successful performance in the English Premier league but was also different depending on the current match status (whether a team was winning, losing or drawing at the time of the possession). Similarly, Lago and Martin (2007) also found that, independent of team level, teams had longer possessions when winning than when losing. Other independent variables thought to influence match performance include match venue (e.g. Carron, et al., 2005; Downward and Jones, 2007), team and opposition quality (Stefani, 1998), and attacking style (Tenga et al., 2010) but more recently combinations of them (Taylor et al., 2008; Sampaio et al., 2010). Indeed, a recent critical review of Performance analysis research in football (Mackenzie and Cushion, 2013) found that many published papers did not take into account the independent variables highlighted as important in other papers. In this wide ranging paper Mackenzie and Cushion considered many methodological issues relevant to Performance Analysis research e.g. sampling techniques and reliability, and suggested that in the future more emphasis on how this type of research impacts on actual sports performance is needed. In a follow up letter to the editor Carling et al. (2014) discuss the points raised by the

Mackenzie and Cushion paper and suggest that Performance Analysis has been variously described as “an academic discipline, a set of data collection tools, an applied practice and a sub-process within the broader coaching process” (p. 6). Interestingly they also suggest that two distinct Performance Analysis practices now exist, research into sports performance for understanding and more applied enquiries related to what happens and what can be done to assist specific teams and individuals.

Performance Analysis in the applied world

Following the early forays (between 1988 and 2003) into sports clubs and organisations by academics such as Mike Hughes (e.g. England Squash, Badminton Association of England, Football Association of Wales) and Nic James (e.g. Welsh Rugby Union, Swansea City AFC, Swansea RFU) the demand for part time and more recently full time positions as Performance Analysts are now plentiful. This expansion in demand (top football clubs now have up to 14 full time Performance Analysts) has coincided with the introduction and evolution of specific Performance Analysis software and hardware.

The advent of digital video in the 1990s and the increasing ease of use (price and size) have meant that video capture is available to anyone with a mobile phone. Hence software companies have been quick to provide easy to use tagging and analysis packages for all. Player tracking via GPS, tennis analysis via racket based technology, smart watches to capture heart rate and activity profiles are just a few of the now commonplace tools to allow anyone to undertake some form of Performance Analysis. Many of these solutions were the sole concern of academics less than 20 years ago.

Professional Performance Analysts working for elite teams have access to the latest technology but nevertheless work within constraints mainly related to time. For example a successful football team can play 3 matches within one week. It is usual for the Performance Analysts to provide opposition scouting reports for use by the coaches and players prior to the game. Within a busy playing schedule the time available to produce video clips, statistical facts and any other information means that longer term analysis (rather than preparation for one game) is difficult to do. The way around this problem is to increase the number of Performance Analysts (as some teams are doing) or to work smarter (the compilation of larger databases and intelligent queries).

The future of Performance Analysis

Performance Analysis started out as a sub-discipline of Sports Science, even if some academics questioned the worthiness of this title. Some suggested that Performance Analysis was simply a set of data collection tools (as pointed out by Carling et al., 2014) but, irrespective of this, Performance Analysis used techniques to provide information from actual match performances, unlike some other Sports Science disciplines. Like other Sports Science disciplines Performance Analysis sought out other scientific areas for inspiration into developing techniques. For example business accounting principles for tracking and projecting growth have been used to compute player rankings in rugby (Bracewell, 2003). Performance Analysts are now looking to computer science to learn how to better deal with large data sets, develop more complex data mining techniques and become more sophisticated with data visualisation. The academic world constantly strives to push the boundaries using complex statistical procedures but the gap between research and applied practice will reduce as both parties recognise the importance of understanding data but more importantly the underlying trends and factors which explain the variability inherent in sports performance.

Conclusions

Performance Analysis has its roots in academic interest in understanding sports performance better. As technology has advanced and become available to all, Performance Analysis is now commonplace outside of academia. However the analysis outside of academia tends to be based on relatively small data sets, even within professional sports teams and organisations. The adoption of predictive modelling and data visualisation using large data sets will filter its way from computer science into Performance Analysis and ultimately into the non-academic world.

References

- Bracewell, P.J. (2003). Monitoring meaningful rugby ratings. *Journal of Sports Sciences*, 21, 611-620.
- Carling, C., Wright, C., Nelson, L.J. and Bradley, P.S. (2014). Comment on "Performance analysis in football: A critical review and implications for future research". *Journal of Sports Sciences*, 32, 1, 2-7.

Carron, A.V., Loughhead, T.M. and Bray, S.R. (2005). The home advantage in sport competitions: Courneya and Carron's (1992) conceptual framework a decade later. *Journal of Sports Sciences*, 23, 4, 395-407.

Downey, J.C. (1973). *The Singles Game*. London: E.P. Publications.

Downard, P. and Jones, M. (2007). Effects of crowd size on referee decisions: Analysis of the FA Cup. *Journal of Sports Sciences*, 25, 14, 1541-1545.

Fullerton, H.S. (1912). The inside game: the science of baseball. *The American Magazine*, LXX, 2-13.

Hughes, C. (1987). The Football Association coaching book of soccer tactics and skills. Queen Anne Press, London.

Hughes, M.D., Evans, S. and Wells, J. (2001). Establishing normative profiles in performance analysis. *International Journal of Performance Analysis in Sport*, 1, 1-26.

Hughes, M.D. and Bartlett, R.M. (2002). The use of performance indicators in performance analysis. *Journal of Sports Sciences*, 20, 739-754.

Hughes, M. and Franks, I.M. (2005). Analysis of passing sequences, shots and goals in soccer. *Journal of Sports Sciences*, 23, 5, 509-514.

James, N., Mellalieu, S.D. and Jones, N.M.P. (2005). The development of position-specific performance indicators in professional rugby union. *Journal of Sports Sciences*, 23, 1, 63-72.

Jones, P., James, N. and Mellalieu, S.D. (2004). Possession as a Performance Indicator in Soccer. *International Journal of Performance Analysis in Sport*, 4, 1, 98-102.

Laban, R. (1963). *Modern Educational Dance*. 2nd edition revised by L. Ullmann. London: MacDonal and Evans. (First published 1948).

Lago, C. and Martin, R. (2007). Determinants of possession of the ball in soccer. *Journal of Sports Sciences*, 25, 9, 969-974.

Mackenzie, R. and Cushion, C. (2013). Performance analysis in football: A critical review and implications for future research. *Journal of Sports Sciences*, 31, 6, 639-676.

Messersmith, L.L. and Corey, S.M. (1931). Distance Traversed by a Basketball Player. *Research Quarterly*, 2, 2, 57-60.

O'Donoghue, P.G. (2005). Normative profiles of sport performance. *International Journal of Performance Analysis in Sport*, 5, 1, 104-119.

Pollard, R., (2002). Charles Reep (1904-2002): pioneer of notational and performance analysis in football. *Journal of Sports Sciences*, 20, 10, 853-855.

Reep, C. and Benjamin, B. (1968). Skill and chance in association football. *Journal of the Royal Statistical Society. Series A (General)*, 131, 4, 581-585.

Reilly, T. and Thomas, V. (1976). A motion analysis of work-rate in different positional roles in professional football match-play. *Journal of Human Movement Studies*, 2, 87-97.

Sampaio, J., Lago, C., Casais, L. and Leite N. (2010). Effects of starting score-line, game location, and quality of opposition in basketball quarter score. *European Journal of Sport Science*, 10, 6, 391-396.

Sanderson, F.H. and Way K.I.M. (1977). The development of an objective method of game analysis in squash rackets. *British Journal of Sports Medicine*, 11, 188.

Stefani, R. (1998). Predicting Outcomes. In *Statistics in Sport* (edited by J. Bennett), pp.249-275. London: Arnold.

Taylor, J.B., Mellalieu, S.D., James, N. and Shearer, D.A. (2008). The Influence of Match Location, Quality of Opposition, and Match Status on Technical Performance in Professional Association Football. *Journal of Sports Sciences*, 26, 9, 885-895.

Tenga, A., Holme, I., Ronglan, L.T. and Bahr, R. (2010). Effects of playing tactics on goal scoring in Norwegian professional soccer. *Journal of Sports Sciences*, 28, 3, 237-244.

Ergogenic effects of guanidinoacetic acid

Sergej M. Ostojic^{1,2}

¹ Faculty of Sport and PE, University of Novi Sad, Novi Sad, Serbia

² University of Belgrade School of Medicine, Belgrade, Serbia

Abstract

Guanidinoacetic acid (GAA) is a natural precursor of creatine and an innovative dietary additive. Here we advance recent studies about performance-enhancing effects of GAA in clinical and athletic environment. GAA seems to improve muscular strength performance in healthy volunteers, and patients with chronic fatigue syndrome. Although long-term studies are not available at the moment, GAA could be considered as relatively safe nutritional additive.

Keywords: Guanidinoacetic acid; Creatine; Exercise performance; Strength

Introduction

Guanidinoacetic acid (GAA; also known as glycocyamine, betacyamine and guanil glycine) is an amino acid derivative and natural precursor of creatine, the latter being phosphorylated and playing an important role as an energy carrier in the cell. GAA is particularly important for energy metabolism in energy-demanding tissues, such as the skeletal muscle or brain, with GAA mainly produced by the kidney and pancreas (Edison *et al.* 2007). It seems the formation of GAA and creatine cannot be reversed, with creatine synthesis from GAA increases methylation demand (Stead *et al.* 2001). GAA was firstly identified as an endogenous substance in human urine in 1934 (Weber 1934), while first clinical trials with exogenous GAA started two decades afterwards in USA (Borsook *et al.* 1951). Beneficial effects of supplemental GAA (co-administered with betaine) has been reported in patients with cardiac decompensation, heart disease, arthritis, poliomyelitis, depression and motor-neuron disease, with most subjects demonstrated an improved sense of well-

being, less fatigue and greater general strength and endurance after GAA intake. In addition, decreased plasma GAA is found in humans with end-stage renal disease (Torremans *et al.* 2006; Tsubakihara *et al.* 2012), with decreased muscle mass and power in uremic patients restored by long-term GAA administration (Tsubakihara *et al.* 1999).

Performance-enhancing effects of GAA

Albeit studies from the 1950-s were on the sick and had poor methodology and design, authors speculated that the performance-enhancing effects of GAA could be due to creatine-boosting action of supplemental GAA, and/or improved availability of dimethylglycine for incorporation into tissue proteins, providing repair of damaged muscle cells (Borsook *et al.* 1951). GAA appeared on sport supplement market in 1980-s as a promising new dietary agent due to its creatine-recovery effect, high bioavailability and cost-effectiveness (Baker 2009; Ostojic *et al.* 2013). Anecdotal claims for GAA suggested greater-than-normal gains in both muscle size and strength and enhanced recovery after exercise, gradual transformation to creatine, along with no non-responders to GAA and synergistic effect with creatine, although most of these claims have not been evaluated in controlled studies. Recent studies reported that supplemental GAA improved muscular performance when administered for 6 weeks in healthy men and women, with no dose-response differences were found between trials (Ostojic *et al.* 2015). GAA can be used as ergogenic agent even at low doses (1.2 grams per day) to enhance upper body strength. Supplemental GAA appears to improve both isometric and dynamic exercise performance, with no dose-response effects in dose up to 4.8 g/day, and no effects on several indices of anaerobic and aerobic performance. In addition, GAA intervention induced an increase in serum and urinary GAA and creatine, with serum homocysteine increased in a dose-response manner and clinical hyperhomocysteinemia (above 11 $\mu\text{mol/L}$) reported rarely, and no major disturbances in clinical markers (Ostojic *et al.* 2014). The exact mechanism of ergogenic action of GAA is yet to be revealed, and may include: (1) increased cellular bioenergetics through enhanced creatine biosynthesis; (2) anabolic stimulus through stimulation of insulin secretion; (3) enhanced metabolic utilization of arginine that affects muscular growth and performance; (4) interaction with peripheral gamma-aminobutyric acid (GABA) receptors and regulation of GABA synthesis and utilization; (5) increased availability of dimethylglycine for incorporation into tissue proteins; and (6) utilization of phosphorylated GAA as an alternative to phosphocreatine (Ostojic *et al.* 2015).

Conclusion

GAA is an old nutritional additive rediscovered, perhaps favorable due to its solubility in water (~ 3600 mg/L), stability (e.g. highly stable in neutral and slightly acidic pH aqueous solutions) and reasonable cost. GAA is a promising performance-enhancing agent that should be co-administered with methyl donors for better safety, with possible beneficial effects besides creatine-recovery effect.

References

- Baker DH. *Amino Acids*. 2009, 37, 29-41.
- Borsook ME, Borsook H. *Ann West Med Surg*. 1951, 5, 830-855.
- Edison EE et al. *Am J Physiol Renal Physiol*. 2007, 293, F1799-804.
- Ostojic SM et al. *Int J Med Sci*. 2013, 10, 141-147.
- Ostojic SM et al. *Eur J Nutr*. 2014, 53, 1637-1643.
- Ostojic SM et al. *J Investig Med*. 2015 (in press).
- Stead LM et al. *Am J Physiol Endocrinol Metab*. 2001, 281, E1095-1100.
- Torremans A et al. *Kidney Int*. 2006, 69, 2003-2012.
- Tsubakihara Y et al. *Kid Res Clin Pract*. 2012, 31, A81.
- Tsubakihara Y et al. Tokyo: Blackwell Science Asia, 1999, 139-44.
- Weber CJ. *Exp Biol Med*. 1934, 32, 172-174.

Reeducation sensorimotor: from the research to clinical practice

Raul Oliveira, PT, PhD

*Laboratory of Motor Behavior. Human Kinetics Faculty,
University of Lisbon, Portugal*

Introduction

Physiotherapy is the science and practice to prevent, assess and treat movement disorders. Knowledge and understanding of the mechanisms and processes of (re) motor learning, the control of human movement and any changes in the case of neuro-musculo-skeletal disorders are essential in implementing the appropriate strategies to efficiently restore functionality.

The sensorimotor or neuromotor reeducation should be based thus on neurophysiological and biomechanical principles neuromuscular control. The evolution of Physiotherapy as a scientific discipline based on evidence still requires an applied or clinical research studies that integrate the most current concepts of neuroscience in clinical practice.

This oral presentation/lecture aims to:

- a) Review and briefly describe the key concepts of neuromuscular control that underlie the practice and current research;
- b) To present and describe some of the research projects completed or in progress in our laboratory;
- c) To characterize the principles of sensory-motor rehabilitation showing a model and some examples. We present some progression criteria and control parameters in these examples.

Neuromotor control & the sensorimotor system – key concepts

Sensorimotor control refers to central nervous system (CNS) control of movement, balance, posture, and joint stability (Lephart et al., 2000; Franklin and Wolpert, 2011). Well-adapted motor actions require intact and well

integrated information from all of the sensory systems, specifically the visual, vestibular and somatosensory systems, including proprioception (Ghez, 1991; Lephart et al., 1997).

The sensorimotor system, a functional unit of the comprehensive motor control system of the body, is extremely complex and has some different dimensions. The term *sensorimotor system* was adopted by the participants of the 1997 Foundation of Sports Medicine Education and Research workshop to describe the sensory, motor, and central integration and processing components involved in maintaining joint homeostasis during bodily movements (functional joint stability) (Lephart et al., 2003).

The components giving rise to functional joint stability must be flexible and adaptable because the required levels vary among both persons and tasks. The process of maintaining functional joint stability is accomplished through a complementary and constant interaction between static and dynamic components. Joint capsule, ligaments, cartilage, friction, and the bony architecture within the articulation comprise the static (passive) components. (Lew et al, 1993; Johansson & Sjolander, 1993). Dynamic contributions arise from feedforward and feedback neuromotor mechanisms over the skeletal muscles crossing the joint. Underlying the effectiveness of the dynamic restraints are the biomechanical and physical characteristics of the joint.

Neuromuscular control is a frequently used term in many disciplines related to motor control. It can refer to any of the aspects surrounding nervous system control over muscle activation and the factors contributing to task performance. Specifically, from a joint stability perspective, we define neuromuscular control as the unconscious activation of dynamic restraints occurring in preparation for and in response to joint motion and loading for the purpose of maintaining and restoring functional joint stability. Although neuromuscular control underlies all motor activities in some form, it is not easily separated from the neural commands controlling the overall motor program (Rietmann & Lephart, 2002). In our brain are depicted actions or movements operationalized through motor programs that have a purpose and not muscles in isolation. For example, in shoulder overhead activities like tennis serve or javelin throw, particular neuromuscular activation sequences and coordination occur between the rotator cuff muscles and scapula muscles (*scapulo-humeral rhythm*) to ensure that the optimal glenohumeral alignment and compression required for dynamic joint stability are provided. These muscle activations take place unconsciously and synonymously with the

voluntary muscle activations directly associated with the particulars of the task (ie, aiming, speed, distance, range of movement). Proprioceptive information concerning the status of the joint and associated structures is essential for neuromuscular control. (Rietmann & Lephart, 2002).

Proprioception involves conscious or unconscious awareness of joint position (joint position sense), movement (kinesthesia), and force, heaviness, and effort (force sense) (Martin and Jessell, 1991; Riemann and Lephart, 2002). Proprioception is processed at all levels of the Central Nervous System (CNS) and is integrated with other somatosensory information (visual and vestibular) before culminating in a final motor command that co-ordinates the activation patterns of skeletal muscles (Ghez, 1991; Shumway-Cook and Woollacott, 2001). Proprioception is the product of sensory information supplied by specialized nerve endings termed mechanoreceptors, i.e., transducers converting mechanical stimuli to action potentials for transmission to the CNS (Martin and Jessell, 1991; Yahia et al., 1992). Mechanoreceptors specifically contributing to proprioception are termed proprioceptors and are found in muscle, tendon, joint and fascia, receptors in the skin can also contribute to proprioception (Martin and Jessell, 1991; Rothwell, 1994). Proprioceptive information is processed at the spinal level, brain stem and higher cortical centers, as well as subcortical cerebral nuclei and cerebellum (Bosco and Poppele, 2001; Amaral, 2013; Lisberger and Thach, 2013; Pearson and Gordon, 2013).

From the spinal cord arise direct motor responses to peripheral sensory information (reflexes) and elementary patterns of motor coordination (rhythmic and central pattern generators). Despite being the most primitive part of the brain from a phylogenetic perspective, (Matthews, 1997) the brain stem contains major circuits that control postural equilibrium and many of the automatic and stereotyped movements of the body (Ghez, 1991; Mihailoff, 1997, Matthews, 1997). In addition to being under direct cortical command and providing an indirect relay station from the cortex to the spinal cord, areas of the brain stem directly regulate and modulate motor activities based on the integration of sensory information from visual, vestibular, and somatosensory sources (Ghez, 1991). In general, the motor cortex is responsible for initiating and controlling more complex and discrete voluntary movements. It is divided into three specialized and somatotopically organized areas, each of which project directly and indirectly (via the brain stem) onto interneurons and motor neurons located in the gray substance of spinal cord. The major direct descending pathway from the motor cortex to the alpha motor neurons and

gamma motor neurons is the corticospinal tract. In addition to influencing motor functions directly, the corticospinal tract also affects motor activity indirectly through the descending brain stem pathways. (Ghez, 1991).

Although the cerebellum and basal ganglia associate areas cannot independently initiate motor activity, they are essential for the execution of coordinated motor control. The cerebellum, operating entirely at a subconscious level, plays a major role in both the planning and modification of motor activities through comparison of the intended movement with the outcome movement. (Ghez, 1991; Dye, 2000). This is accomplished through the continuous inflow of information from the motor control areas and the central and peripheral sensory areas. The cerebellum has three functional divisions. The first division receives vestibular input, both directly and indirectly from the vestibular labyrinth (semicircular and otolith receptors) and, as might be surmised based on the input, is involved with postural equilibrium. The second cerebellar division is mainly responsible for the planning and initiation of movements, especially those requiring precise and rapid dexterous limb movements. It is the third division, the spinocerebellum, which receives the somatosensory information conveyed through the 4 ascending spinocerebellar tracts. In addition to the somatosensory input, this division of the cerebellum also receives input from the vestibular labyrinth and visual and auditory organs. The output from the spinocerebellum serves to adjust ongoing movements through influential connections on the medial and lateral descending tracts in the brain stem and cortex via projections on the vestibular nucleus, reticular formation, red nucleus, and motor cortex. In addition to controlling movements, the spinocerebellum also uses the somatosensory input for feedback regulation of muscle tone through regulation of static g-MN drive to the muscle spindles (Ghez, 1991). Lastly, the cerebellum also receives an efferent copy of the motor commands arriving at the ventral roots of the spinal cord (Dye, 2000). The cerebellum has also been implicated in motor learning and pre-programming of ballistic movements.

The role of proprioception in sensorimotor control is multifactorial. To plan appropriate motor commands, the CNS needs an updated body schema of the biomechanical and spatial properties of the body parts, supplied largely by proprioceptors (Maravita et al., 2003). Proprioception is important also after movement for comparison of actual movement with intended movement, as well as the predicted movement supplied by the efference copy (corollary discharge). This is suggested to have importance for motor learning by updating

of the internal forward model of the motor command (Wolpert et al., 2011). During movements proprioception has importance for: feedback (reactive) and feedforward (preparatory) control, the regulation of muscle stiffness, to achieve specific roles for movement acuity, joint stability, co-ordination and balance (Ghez, 1991; Riemann and Lephart, 2002; Milner et al., 2007). Cervical proprioceptive information also has a highly important specific role for head and eye movement control (Corneil et al., 2002).

Changes and troubles in proprioceptive in-puts have been found to be associated with several neuromusculoskeletal disorders and/or experimental conditions following pain, joint effusion, abnormal movement and/or posture pattern and trauma as well as neural and muscular fatigue.

There are a lot of research studies reported disturbed proprioception in acute and chronic musculoskeletal pain disorders at the cervical (Treleaven et al., 2003; Sjolander et al., 2008) and lumbar (Lee et al., 2010; Williamson and Marshall, 2014) spine, as well as shoulder (Anderson and Wee, 2011), elbow disorders (Juul-Kristensen et al., 2008) and knee disorders (Salahzadeh et al., 2013). When there is pain, proprioception can be disturbed due to altered reflex activity and sensitivity of the gamma-muscle spindle system via activation of chemosensitive type III and IV afferents (nociceptors) (Johansson et al., 2003). Pain can moreover influence body perception at the central level (Rossi et al., 2003; Haggard et al., 2013), including reorganization of the somatosensory cortex (Moseley and Flor, 2012). Thus pain can negatively influence proprioception at both peripheral and central levels of the CNS.

Joint effusions can cause significant inhibition of muscle activation, and can also in the absence of pain, significantly impair extremity proprioception (Cho et al., 2011). Following trauma, and after pain and swelling have resolved, the loss of musculoskeletal tissue and its mechanoreceptors is associated with persistent impairment of proprioception (Borsa et al., 1997; Willems et al., 2002).

A common phenomenon in fatigue conditions after performing hard physical work or exercise (especially eccentric training) is the experience of clumsiness and difficulty performing fine motor tasks, verified in several studies demonstrating impaired proprioception (Weerakkody et al., 2003; Iwasa et al., 2005; Johanson et al., 2011). Thus the potential for increased injury risk exists in fatigue conditions. Associated to the causes reported, deleterious effects on proprioception have also been reported in association with conditions such as local (Lephart et al., 1994) and general (Hall et al., 1995) joint hypermobility,

stenosis (Leinonen et al., 2002) as well as due to immobilization (Moisello et al., 2008).

In acute effects, disturbed proprioception is likely to have adverse influence on feedback and feedforward motor control and the regulation of muscle stiffness. It may also explain various sensorimotor dysfunctions (besides increased errors in specific proprioception tests), which have been reported in the research literature. These dysfunctions include reduced drive to alpha motor neurons (Konishi et al., 2002), disturbed reflex joint stabilization (Beard et al., 1994), increased postural sway in balance tasks (Radebold et al., 2001; Treleaven et al., 2005; Roijezon et al., 2011) and increased error in visual movement acuity tasks (Sandlund et al., 2008; Williamson and Marshall, 2014).

In chronic effects, altered proprioception and subsequent impaired actions outputs from the CNS and deficient muscular protection of joint structures (Hurley, 1999) may be pathophysiologically associated with increased risk of injury and recurrence and persistence of pain disorders, including the onset and progression of secondary (post-injury) osteoarthritis (OA) (Hurley, 1999).

Reduced muscle performance (Elmqvist et al., 1988; Konishi et al., 2002), as a consequence of altered mechanoreceptor input from injured structures to the CNS has been associated with the onset and progression of peripheral joint OA in humans (Segal et al., 2010). Trouble proprioception may also contribute to increased injury risk (Zazulak et al., 2007) and training directed towards improving proprioception has been associated with reduced injury risk (Hupperets et al., 2010).

Each strategy of intervention targeting normalized proprioception and neuromuscular control, is relevant both in prevention and rehabilitation of movement disorders, and must follow some guidelines (Lederman, 2010) based on state of the art from neuroscience:

1. Motor (re)learning and movement control should be associated with its goals: the whole body is organized and involved in the goal of the movement, including all anticipatory postural adjustments and motor pre-programming. The neuromotor programmes are schemes representing movement sequences not singular or specific muscle actions. **All movement is goal or task orientated. Motor control model.**

2. **Muscles work always together in complex synergies** – they never work alone or in an analytic way – **through the CNS coordination** (intra-muscular & intermuscular).

3. **Neuromuscular activation is task-dependent**, their role can change in different tasks. Neuromuscular patterns activation change according to the ongoing task/function or change in the movement parameters. **Functional approach.**

4. **All muscles are equally important in motor pattern**, even the muscles are silent (“off”). Reciprocal innervation is a good example.

5. The proprioception and all somatosensory information are essential for CNS: (a) planning patterns most appropriate and efficient to the purpose; (b) give feedback to immediate adjustments and refinement of movement; (c) motor learning and replenishing/reinforce existing programmes. **Retrain or (re)learning a movement or a task is always reeducate information inherent to this movement/task.** Each and every movement is an opportunity for sensorimotor training.

6. **Pain and fear’s pain, joint effusion, injury and fatigue central or local could have important negative troubles in proprioception and in neuromuscular patterns activation.** We must always respect and understand these effects.

7. **Promoting normal functional movement will “normalize” proprioception and all information** by facilitating positive sensorymotor adaptations. All functional movements have the adequate proprioceptive inputs for motor learning and refinement.

8. The main objective of neuromuscular rehabilitation is **to bring motor control to an autonomous state where it becomes part of habitual movement repertoire.** This requires practice.

9. For effective motor learning, **this practice must to apply some principles:** a) to know the cognitive components of the practice; b) being active and keep moving are key-words; c) recognize and value feedback information for adjustments and corrections, d) learning by repetition but avoid the repetitions of abnormal or undesirable movements; e) promote the similarity: rehabilitation should apply movement patterns that are similar to and within the context of the movement or task being recovered; f) promote the ability to transfer motor learning for new or unexpected situations and contexts; g) encourage since early the functional autonomy.

10. Learning, retraining, motor organization to injury and/or immobilization and return to functionality partly depend **on the neurophysiological capacity of neuromuscular system to learn and adapt to new experiences and**

stimulus. Central and peripheral adaptations are complementary and occur concurrently.

11. Neuromuscular rehabilitation is more about facilitating cognitive-sensory-motor processes and providing a stimulating and variations-rich environment. It is not just physical exercising.

Indications and applications of sensorimotor programmes:

- a) Primary injuries prevention programs (integrated in training);
- b) Secondary injuries prevention programs after injury and/or reintegration into the training (linked to the training - specific);
- c) Improvement/optimization tasks in instability and/or fatigue contexts (improve specific performance);
- d) Integrated into therapeutic exercise program after an injury or abnormal condition.

2. Ongoing research projects in the laboratory of motor behavior

Study 1 - Reis, Melo & Oliveira. Effects of a Neuromuscular Reeducation Program on the Postural Control in Gymnasts with Chronic Ankle Instability. (2013)

Chronic ankle instability (CAI) is associated to the mechanical and/or functional instability of the ankle, being described as often residual change after sprain.

Objective: To analyze the effects of a neuromuscular reeducation program for six weeks, in postural sway (PS) and time to stabilization (TS), in functional tests, in asymptomatic gymnasts and in gymnasts with CAI.

Methods: The postural variation was evaluated – within sample of 24 gymnasts - 9 with CAI (experimental group) and 15 healthy ones (control group) through a pressure platform, before and after applying the exercise program.

Results and Discussion: In the instability group it was observed an improvement in PS and TS in a single limb static stance with open and closed eyes, and after a landing of an anterior jump, medial and lateral side. In the control group a decrease of the PS in a single-limb static stance with eyes open and after the landing of a medial side jump was verified; improvement of the time to stabilization in the landing of lateral and medial side jump, after applying the exercise program.

Conclusion: A neuromuscular reeducation program had a positive effect in the improvement of the postural control in gymnasts with or without CAI.

Study 2 - Coito, Melo & Oliveira. *Effects of a neuromotor reeducation program on postural control and musculoskeletal injury incidence of amateur football players.* (2014)

Few studies have been made about injury incidence in male amateur football teams, as well as about the effects of a neuromotor training program in the prevention of injuries.

Objectives: to analyze the effects of an eight-week exercise program of neuromotor training on postural control and injury incidence in amateur male football players.

Methods: players of a team of 2B Portuguese Division (n=31, Mean – 22.94 ± 4.12 years) participated in the study. Postural sway measures (centre of pressure, initial peak force and time to stabilization) were evaluated with a force platform within functional tests, before and after the application of an exercise program. Injury assessment was made prospectively during the entire 2012-13 season, there were 36 injuries were registered.

Results and discussion; The mean injury incidence after intervention in the Training Group (TG) was lower than in the Control Group (CG), including ligament injuries (1,71 vs 3,11 injuries / 1000h) and muscle injuries (1.37 vs 2.05 injuries /1000h). A significant improvement in postural control was observed in TG, demonstrated by the decrease of initial peak force (total of 45%) and time to stabilization (total of 50.9%) after a reception of a jump.

Conclusions: The application of eight-week exercise neuromotor program had positive effects on the improvement of postural control, as well as on the reduction of injury incidence and time loss after a ligament and muscle injury in amateur football players.

Study 3. Neves A, Melo F, Oliveira R. *Effects of a neuromotor reeducation program on postural control and musculoskeletal injury prevalence of amateur korfbal players.* (2014)

Ankle sprains may generate mechanical instability and a variety of symptoms, such as chronic ankle instability (CAI), which can be seen as sensorimotor system derangement.

Objectives: To determine the prevalence of injuries in korfball players in two consecutive seasons and analyze the effects of a sensorimotor reeducation program in the prevalence of injuries and in the postural control (PC).

Methods: 18 athletes (age = $23,2 \pm 3,15$ years) allocated in 2 groups: 10 individuals in the Experimental group (EG) and 8 in the Control group (CG). The 8 athletes suffering from CAI were randomly allocated to the groups. EG athletes were submitted to a six weeks sensorimotor reeducation program. The PC was evaluated in two different moments using a force platform. The variables studied were the center of pressure displacement (CPD) and the oscillation area (OA) for static tasks and the initial force peak (IFP), the time to stabilization in the medial-lateral and anteroposterior planes (TTE_ML and TTE_AP, respectively) for dynamic tasks (jumps).

Results and discussion: On the second season there was a reduction of 3 ankle sprains, there were 4 re-injuries and a new ankle sprain. The intervention program was effective only in the TTE_ML of the anteroposterior jump ($p = 0,021$) and on the TTE_AP of the left side jump ($p = 0,041$), on the dominant lower limbs, at a significance level $p < 0,050$.

Conclusions: Injury prevention in Korfball athletes and the improvement in one of the variable of the CP – time to stabilization after a jump landing – seem to benefit from the application of a sensorimotor reeducation program. In futures studies we recommend larger samples and the complementary measures like electromyography or cinematic analysis to study the evidence of these programs on primary and secondary injury prevention.

Sensorymotor reeducation programs – applied principles and some examples

Any sensorimotor rehabilitation program must be personalized, individualized and planned according to the specific needs of each subject. This requires a careful clinical assessment before the implementation any program. The sensorymotor programs should include:

- a) balance and coordination activities;
- b) dynamic joint stability exercises;
- c) plyometric exercises (the stretch-shortening cycle);
- d) Agility drills; Sport-specific demands/ exercises;

It is essential to control a lot of parameters/factors, and the same time they

are criteria for increase the complexity and to have a rationale progression within the program:

- a) Types of support: single leg/limb Vs both leg/limbs; multi-supports; constant / intermittent supports.
- b) Types of surfaces:
 - 1) rigid and stable;
 - 2) rigid and unstable;
 - 3) soft and unstable (Instability unidirectional / multidirectional); regular / irregular
- c) Shoe types (for lower limbs): barefoot; daily shoes; sports specific shoes.
- d) Role of vision: eyes open / eyes closed
- e) Kinetic chain open / Kinetic chain closed exercises: without/with weight bearing (partial / total).
- f) Parameters of exercises:
 - 1) workload total: repetitions/rest time/range of motion/Types of muscular contraction;
 - 2) physiological loads/external loads;
 - 3) uniaxial stimuli Vs multiaxial stimulus;
- g) All movement is goal or task orientated. Motor control model exercises:
 - 1) balance, coordination and control, speed and agility, time reaction and time stabilization, temporal coordinations and rhythm;
 - 2) horizontal/vertical/oblique displacements;
 - 3) jumps (plyometrics) and running progression;
 - 4) direction and/or speed changes: slow and planned Vs fast and unforeseen;
 - 5) programmed responses Vs responses to unforeseen / new situations;
 - 6) tasks centered into the body Vs tasks centered on an external objective – Automatization;
 - 7) basic movements of the sport or daily activities Vs specific and complex movements of the sport or daily activities;
 - 8) manage and control the increased risk of movements;
 - 9) manage and control in fatigue conditions (peripheral / central);
 - 10) Particular considerations in programs for children/adolescents and in some conditions for women.

We will present some movies and images that illustrate the application of these principles in some practical clinical cases in subjects with disorders of the shoulder and ankle/knee (chronic joint instability).

References

Amaral D. The functional organization of perception and movement. In: Kandel E, Schwartz J, Jessell T, Siegelbaum S, Hudspeth A, editors. *Principles of Neural Science*. New York: McGraw Hill; 2013. p. 356 - 69.

Anderson VB, Wee E. Impaired joint proprioception at higher shoulder elevations in chronic rotator cuff pathology. *Arch Phys Med Rehabil* 2011; 92(7): 1146-51.

Beard DJ, Kyberd PJ, Oconnor JJ, Fergusson CM, Dodd CAF. Reflex hamstring contraction latency in anterior cruciate ligament deficiency. *J Orthop Res* 1994; 12(2): 219-28.

Borsa P, Lephart S, Irrgang J, Safran M, Fu F. The effects of joint position and direction of joint motion on proprioceptive sensibility in anterior cruciate ligament-deficient athletes. *Am J Sports Med* 1997;25 (3): 336-40.

Bosco G, Poppele RE. Proprioception from a spinocerebellar perspective. *Physiol Rev* 2001; 81(2): 539 -68.

Cho Y, Hong B, Lim S, Kim H, Ko Y, Im S, et al. Effects of joint effusion on proprioception in patients with knee osteoarthritis: a single-blind, randomized controlled clinical trial. *Osteoarthr Cartil* 2011; 19(1): 22-8.

Coito, J, Coito J, Melo F, Oliveira R Effects of a neuromotor reeducation program on postural control and musculoskeletal injury incidence of amateur football players. Master Thesis in Physiotherapy Sciences. Human Kinetics Faculty, University of Lisbon (2014).

Corneil BD, Olivier E, Munoz DP. Neck muscle responses to stimulation of monkey superior colliculus. I. Topography and manipulation of stimulation parameters. *J Neurophysiol* 2002; 88(4): 1980 - 99.

Dye SF. The functional anatomy of the cerebellum: an overview. In: Lephart SM, Fu FH, eds. *Proprioception and Neuromuscular Control in Joint Stability*. Champaign, IL: Human Kinetics; 2000: 31-35.

Elmqvist L, Lorentzon R, Johansson C, Fugl-Meyer A. Does a torn anterior cruciate ligament lead to change in the central nervous drive of the knee extensors? *Eur J Appl Physiol* 1988; 58(1e2): 203-7.

Ghez C. Voluntary movement. In: Kandel E, Schwartz J, Jessell T, editors. *Principles of Neural Science*. London: Prentice-Hall International Inc.; 1991. p. 609 - 25.

Franklin DW, Wolpert DM. Computational mechanisms of sensorimotor control. *Neuron* 2011; 72(3):425 - 42.

Franklin DW, Osu R, Burdet E, Kawato M, Milner TE. Adaptation to stable and unstable dynamics achieved by combined impedance control and inverse dynamics model. *J Neurophysiol* 2003; 90(5): 3270 - 82.

Haggard P, Iannetti GD, Longo MR. Spatial sensory organization and body representation in pain perception. *Curr Biol* 2013; 23(4):R164-76.

Hall MG, Ferrell WR, Sturrock RD, Hamblen DL, Baxendale RH. The effect of the hypermobility syndrome on knee-joint proprioception. *Br J Rheumatol* 1995;34 (2):121-5.

Hupperets MDW, Verhagen E, Heymans MW, Bosmans JE, van Tulder MW, van Mechelen W. Potential savings of a program to prevent ankle sprain recurrence economic evaluation of a randomized controlled trial. *Am J Sports Med* 2010; 38(11): 2194-200.

Hurley M. The effects of joint damage on muscle function, proprioception and rehabilitation. *Man Ther* 1997; 2(1): 11-7.

Hurley M. The role of muscle weakness in the pathogenesis of osteoarthritis. *Rheum Dis Clin North Am* 1999; 25(2): 283-98.

Iwasa K, Miyamoto K, Shimizu K. Effects of erector spinae muscle fatigue on trunk repositioning accuracy in forward and lateral flexion. *J Back Musculoskelet Rehabil* 2005; 18 (3e4): 61-6.

Jessel J, Jessel T. Modality coding in the somatic sensory system. In: Kandel E, Schwartz J, Jessell T, editors. *Principles of neural science*. London: Prentice-Hall International Inc.; 1991. p. 341 - 52.

Johanson E, Brumagne S, Janssens L, Pijnenburg M, Claeys K, Paasuke M. The effect of acute back muscle fatigue on postural control strategy in people with and without recurrent low back pain. *Eur Spine J* 2011; 20(12):2152-9.

Johansson H, Sjolander P. The neurophysiology of joints. In: Wright V, Radin EL, eds. *Mechanics of Joints: Physiology, Pathophysiology and Treatment*. New York, NY: Marcel Dekker Inc; 1993: 243–290.

Johansson H, Arendt-Nilsson L, Bergenheim M, Blair S, van Dieen J, Djupsjöbacka M, et al. Epilogue: an integrated model for chronic work-

related myalgia "Brussels Model". In: Johansson H, Windhorst U, Djupsjöbacka M, Passatore M, editors. Chronic work-related myalgia. Neuromuscular mechanisms behind work related chronic muscle pain syndromes. Gavle University Press; 2003.

Juul-Kristensen B, Lund H, Hansen K, Christensen H, Donneskiold-Samsoe B, Bliddal H. Poorer elbow proprioception in patients with lateral epicondylitis than in healthy controls: a cross-sectional study. *J Shoulder Elb Surg* 2008; 17(1): 72S-81S.

Konishi Y, Fukubayashi T, Takeshita D. Possible mechanism of quadriceps femoris weakness in patients with ruptured anterior cruciate ligament. *Med Sci Sports Exerc* 2002; 34(9): 1414-8.

Lederman E. Neuromuscular reahabilitation in manual and physical therapies: principles to practice. Churchill Livingstone, 1 st ed, 2010.

Lephart SM, Warner JJ, Borsa PA, Fu FH. Proprioception of the shoulder joint in healthy, unstable, and surgically repaired shoulders. *J Shoulder Elb Surg Am Shoulder Elb Surg* 1994; 3(6): 371-80.

Lephart S, Pincivero D, Giraldo J, Fu F. The role of proprioception in the management and rehabilitation of athletic injuries. *Am J Sports Med* 1997; 25(1): 130 -7.

Lephart S, Riemann F, Fu F. In: Lephart S, Fu F, editors. Introduction to the sensorimotor system. Proprioception and neuromuscular control in joint stability. Illinois: Human Kinetics; 2000. xviiexxiv.

Lephart SM, Riemann BL, Fu FH. Introduction to the sensorimotor system. In: Lephart SM, Fu FH, eds. *Proprioception and Neuromuscular Control in Joint Stability*. Champaign, IL: Human Kinetics; 2000: 37–51.

Lee AS, Cholewicki J, Reeves NP, Zazulak BT, Mysliwiec LW. Comparison of trunk proprioception between patients with low back pain and healthy controls. *Arch Phys Med Rehabil* 2010; 91(9): 1327-31.

Leinonen V, Maatta S, Taimela S, Herno A, Kankaanpaa M, Partanen J, et al. Impaired lumbar movement perception in association with postural stability and motor and somatosensory-evoked potentials in lumbar spinal stenosis. *Spine* 2002; 27(9): 975-83.

Lew WD, Lewis JL, Craig EV. Stabilization by capsule, ligaments and labrum: stability at the extremes of motion. In: Matsen FA, Fu FH, Hawkins RJ, eds. *The Shoulder: A Balance of Mobility and Stability*. Rosemont, IL: American Academy of Orthopaedic Surgeons; 1993: 69–89.

Lisberger S, Thach T. In: Kandel E, Schwartz J, Jessell T, Siegelbaum S, Hudspeth A, editors. *The cerebellum. Principles of neural science*. New York: McGraw Hill; 2013. p. 960 - 81.

Pearson K, Gordon J. In: Kandel E, Schwartz J, Jessell T, Siegelbaum S, Hudspeth A, editors. *Spinal reflexes. Principles of neural science*. New York: McGraw Hill; 2013. p. 790 - 811.

Maravita A, Spence C, Driver J. Multisensory integration and the body schema: close to hand and within reach. *Curr Biol* 2003; 13 (13): R531-9.

Martin J, Jessell T. Modality coding in the somatic sensory system. In: Kandel E, Schwartz J, Jessell T, editors. *Principles of neural science*. London: Prentice-Hall International Inc.; 1991. p. 341-52.

Matthews GG. Brain motor mechanisms. In: Matthews GG, ed. *Neurobiology: Molecules, Cells & Systems*. Malden, MA: Blackwell Science Inc; 1997: 234.

Matthews GG. Brain motor mechanisms. In: Matthews GG, ed. *Neurobiology: Molecules, Cells & Systems*. Malden, MA: Blackwell Science eds. *Fundamental Neuroscience*. New York, NY: Churchill Livingstone Inc; 1997: 335-346.

Mihailoff GA, Haines DE. Motor system I: peripheral sensory, brainstem and spinal influence on ventral horn neurons. In: Haines DE, Ard MD, eds. *Fundamental Neuroscience*. New York, NY: Churchill Livingstone Inc; 1997: 335-346.

Milner TE, Hinder MR, Franklin DW. How is somatosensory information used to adapt to changes in the mechanical environment? *Comput Neurosci Theor Insights Brain Funct* 2007; 165: 363-72.

Moisello C, Bove M, Huber R, Abbruzzese G, Battaglia F, Tononi G, et al. Short-term limb immobilization affects motor performance. *Journal of motor behavior* 2008; 40(2): 165-76.

Moseley GL, Flor H. Targeting cortical representations in the treatment of chronic pain: a review. *Neurorehabil Neural Repair* 2012; 26(6): 646-52.

Neves A, Melo F, Oliveira R. Effects of a neuromotor reeducation program on postural control and musculoskeletal injury prevalence of amateur korfbal players. Master Thesis in Physiotherapy Sciences. Human Kinetics Faculty. University of Lisbon (2014).

Radebold A, Cholewicki J, Polzhofer GK, Greene HS. Impaired postural control of the lumbar spine is associated with delayed muscle response times in patients with chronic idiopathic low back pain. *Spine* 2001; 26(7):724-30.

Riemann BL, Lephart, SM. The Sensorimotor System, Part I: The Physiologic Basis of Functional Joint Stability. *Journal of Athletic Training* 2002; 37(1): 71–79.

Reis, M, Melo, F, Oliveira, R. Effects of a Neuromuscular Reeducation Program on the Postural Control in Gymnasts with Chronic Ankle Instability. Book of Proceedings International Congress on Sports science Research and Technology Support – ICSports – 2013.

Roijezon U, Bjorklund M, Djupsjobacka M. The slow and fast components of postural sway in chronic neck pain. *Man Ther* 2011; 16(3): 273-8.

Rossi S, Della Volpe R, Ginanneschi F, Ulivelli M, Baildini S, Spidalieri R, et al. Early somatosensory processing during tonic muscle pain in humans: relation to loss of proprioception and motor 'defensive' strategies. *Clin Neurophysiol* 2003; 114 (7): 1351-8.

Rothwell J. Control of human voluntary movement. London: Chapman and Hall; 1994.

Salahzadeh Z, Maroufi N, Salavati M, Aslezaker F, Morteza N, Hachesu PR. Proprioception in subjects with patellofemoral pain syndrome: using the sense of force accuracy. *J Musculoskeletal Pain* 2013; 21(4): 341-9.

Sandlund J, Roijezon U, Bjorklund M, Djupsjobacka M. Acuity of goal-directed arm movements to visible targets in chronic neck pain. *J Rehabil Med* 2008; 40(5): 366-74.

Segal N, Glass N, Torner J, Yang M, Felson D, Sharma L, et al. Quadriceps weakness predicts risk for knee joint space narrowing in women in the MOST cohort. *Osteoarthritis Cartilage* 2010; 18(6): 769-75.

Shumway-Cook A, Woollacott M. Motor control. Theory and practical applications. Philadelphia, Lippincott: Williams & Wilkins; 2001.

Sjolander P, Michaelson P, Jaric S, Djupsjobacka M. Sensorimotor disturbances in chronic neck pain - range of motion, peak velocity, smoothness of movement, and repositioning acuity. *Man Ther* 2008; 13(2):122-31.

Treleaven J, Jull G, Low Choy N. Standing balance in persistent WAD – comparison between subjects with and without dizziness. *J Rehabil Med* 2005; 37(4): 224-9.

Treleaven J. Sensorimotor disturbances in neck disorders affecting postural stability, head and eye movement control. *Man Ther* 2008; 13(1):2-11.

Weerakkody NS, Blouin JS, Taylor JL, Gandevia SC. Local subcutaneous and muscle pain impairs detection of passive movements at the human thumb. *J Physiol Lond* 2008; 586(13): 3183-93.

Willems T, Witvrouw E, Verstuyft J, Vaes P, De Clercq D. Proprioception and muscle strength in subjects with a history of ankle sprains and chronic instability. *J Athl Train* 2002; 37(4): 487e93.

Williamson EM, Marshall PH. Effect of osteoarthritis on accuracy of continuous tracking leg movement. *Percept Mot Ski* 2014; 118(1): 162-82.

Wolpert DM, Diedrichsen J, Flanagan JR. Principles of sensorimotor learning. *Nat Rev Neurosci* 2011; 12 (12):739 - 51.

Yahia L, Rhalmi S, Newman N, Isler M. Sensory innervation of human thoracolumbar fascia. An immunohistochemical study. *Acta Orthop Scand* 1992; 63(2):195 -7.

Zazulak BT, Hewett TE, Reeves NP, Goldberg B, Cholewicki J. The effects of core proprioception on knee injury – a prospective biomechanical-epidemiological study. *Am J Sports Med* 2007; 35(3): 368-73.

Learn to move – the role of fundamental motor patterns in child’s motor development

Rado Pišot and Matej Plevnik

*University of Primorska, Science and Research Centre, Institute for Kinesiology
Research, Koper, Slovenia*

Abstract

Motor competence as the basis of human motor capital, which represents the fundamental lever in the overall functioning of human beings and in the process of preserving and guaranteeing health, is one of those essential human abilities that significantly contribute to the quality of life and development of an individual over their lifetime. Modern lifestyle inputs many various environmental impulses in a child’s motor development. These impulses mostly have a negative connotation. Only an environment that is rich in content, diverse and sufficiently stimulating can ensure the developmental stimuli that are the prerequisite for a child to establish an appropriate relationship with persons and objects in the environment. Learning and mastering various fundamental motor patterns – walking, running, climbing, crawling and others, which are mostly phylogenetically conditioned, inherited and typical for humans as a species, have an exceptional role in a child’s development and in the process of mastering important motor competences. This extensive study entitled *Analysis of Fundamental Motor Patterns, Skeletal and Muscular Adaptation to Specific Sedentary Lifestyle Factors in Children Aged 4 – 7 Years* was conducted with the purpose of examining the mechanisms involved in the development, execution and adaptation of fundamental motor patterns. - The results of this study in comparison with other similar studies will be presented to facilitate the introduction of the necessary adaptations to the environment and create the incentives required to help a child develop these vitally important factors of development.

Keywords: child, motor development, learning, fundamental motor pattern

Introduction

Movement has accompanied humans through the entire history, because people are created to be active and to move. In the past, human development adapted to man's activities and the living environment. Certain motor structures were developed (w.g. bipedality, motor pattern of diagonal reciprocal activation and other) that enabled survival and maximally efficient movement for survival needs. Therefore, the need for survival has developed man into an effective physical and motor system. Man functioned in an environment that encouraged regular and effective use of fundamental motor patterns (FMPs) - walking, running, jumping, climbing, crawling and other types of movement. Many authors who study the human motor development (Walkley, Armstrong and Clohesy, 1998; Gallahue and Ozmun, 1998; Harrington, 2005; Stodden et al., 2008; Rajtmajer, 1997; Pišot and Planinšec, 2005; Videmšek and Pišot, 2007; Pišot et al., 2010, Škof, 2010), emphasise the major value of appropriate mastering of motor patterns to avoid problems in future motor development. For adults to avoid inappropriate adaptations and developmental anomalies in everyday life, to appropriately and sufficiently move during work and in free time and contribute to the quality of life, special attention must be given to motor development and the acquisition of appropriate motor competences in early childhood. The use of elementary forms of movement in close connection to the environment, where a child lives. Only an environment that is rich in content, diverse and sufficiently stimulative can ensure developmental stimuli that are the condition for a child to establish an appropriate relation with persons and objects in the environment. Child's own activity that represents conscious and active functioning is extremely important. Children are active co-creators of their own knowledge, skills and also their own development (according to Pišot and Planinšec, 2005). Many authors (Malina, Bouchard and Bar-Or, 2004; Gallahue, Ozmun and Goodway, 2011; Haywood and Getchell, 2001) state that children achieve the level of mastering fundamental motor patterns (FMP) until the end of early childhood. The newest researches (Okely and Booth, 2004; Pišot et al., 2010) have unfortunately showed that the level of mastering FMP among children is declining due to an aggressive lifestyle. Therefore, many children master the mentioned patterns during later periods of life. It can also happen many times that due to chronic injuries of the skeletomuscular apparatus, some children

do not master fundamental motor patterns until the phase when they should master them. Gallahue and Ozmun (1998) warn that spontaneously, in their development, children completely master patterns only to the level that includes the rudimentary motor development phase or the period from one to two years of age. The development of fundamental motor elements, i.e. the FMP, is therefore becoming unsatisfactory, which is confirmed by the results of many researches (Walkley, Armstrong and Clohesy, 1998; NSW Department of Health, 2003; Harrington, 2005; Gallahue and Ozmun, 1998; Pišot et al., 2012). Some everyday motor patterns (especially walking, and running and jumping in a smaller extent) still achieve a modern level of development, while other (especially climbing and crawling) disappear from the everyday life of the modern child due to the lack of use (Playday, 2007; Plevnik, 2011).

Motor development comprises of dynamical and mostly continuing changes in the motor behaviour which reflect in the development of motor (coordination, strength, speed, balance, flexibility and precision) and functional skills (endurance) as well as motor knowledge that together compose the zone of motor competences and are manifested as stability, locomotor and manipulative skills (Pišot and Planinšec, 2005; Gallahue, Ozmun and Goodway, 2011; Pišot, 2012). In development, a child constantly faces motor learning and the mastering of new, increasingly demanding motor competences, which is mostly conditioned with the level of motor skills. The higher the level of the development of motor skills, the more succes will the parallel process of motor learning be, and consequently the mastering of motor competences will reach a higher level, which will be reflected in quality performance of various motor skills (adapted according to Pišot, 2012). Motor competence as the basis of human motor capital, which in the comprehensive functioning of man and in the process of preserving and guaranteeing health presents the fundamental lever, is one of those necessary human abilities that during lifetime significantly contributes to the quality of life and development. Therefore, the period which is nowadays dedicated to monitoring and studying the motor development of an individual by considering the role of sustainability and from the ecological perspective, is named competence-oriented period. The consideration model which sets motor competences to the forefront in the starting point and during problem goal follow-up, is called the competency model of motor development (Pišot, 2012).

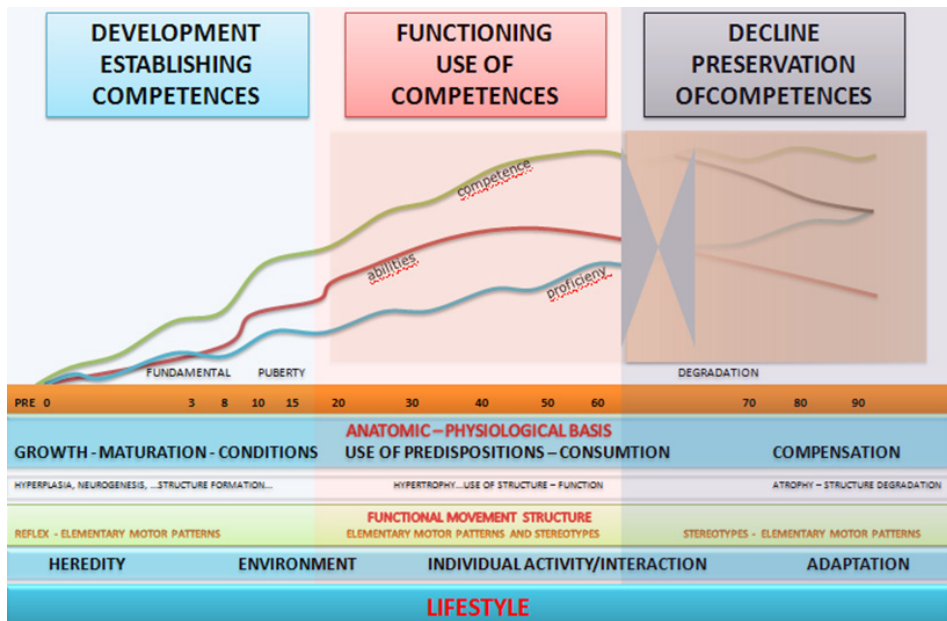

Figure 1: Competency model of motor development (Pišot, 2012)

The multi-dimensional competency model (Pišot, Plevnik, Mohorko, Pišot, Marušič and Šimunič, 2012; Pišot, 2012), which emerged as a detailed upgrade of preliminary motor development models, defines FMP as the basis for establishing a motor competence (regardless of the individual's age, functional orientation, movement goal or level of movement implementation), which play a different role in an individual through three fundamental periods: development – building of competences; active functioning – utilisation of competences, and calming – decline of motor competences. The model bases on the mechanisms of changes that follow the process of body growth and development, anatomical and physiological (biological basis) bases and considers the impact of heredity, individual's activity and the environment. It sets FMP as functional movement structure to the focal point of all movements that a person needs and performs in everyday life through various life periods. The model sets the optimisation of performing FMP with the goal of harmonised development, sport result, appropriate rehabilitation or quality motor learning as the orientation for the selection of appropriate programmes, contents and interventions.

INVITED LECTURES
POZVANA PREDAVANJA

Importance and role of fmp in the child's motor development

Learning and mastering various types of movement, which are mostly phylogenetically conditioned, inherited and typical for humans as a species, have an exceptional meaning in the child's development and the process of mastering important motor competences. FMP, determined as simple motor patterns, occur early in a child's life and present the basis for further complex motor stereotypes. FMP like walking, running, climbing, crawling, creeping, throwing, kicking and other, are necessary for a harmonised human motor development and are in individual's motor needs focused mostly in satisfying the quantitative value of movement and achieving a goal, at the same time the quality of that movement is not in the forefront (Videmšek and Pišot, 2007).

FMP are significant in further development of motor stereotypes that enable us to interact with the environment and also a quality motor manipulation. Appropriate motor competences can be acquired only by a child who gets an appropriate amount and quality of motor experiences in early developmental period. These experiences guarantee the mastering of motor knowledge and the development of motor abilities, fundamental factors of motor competence. Modern lifestyle and the environment in which children are living today are far from stimulative. Inappropriately learned FMP have a negative impact on the upgrade of motor stereotypes and consequently on inappropriate and irregular physical activity (PA) in adulthood (Pišot, Šimunič, Šarabon, Cankar, Jelovčan, Plevnik et al., 2010; Pišot and Šimunič, 2013). Okley, Booth and Patterson (2001) have found that the result of motor tests of adolescents is statistically typically connected to their participation in organised PA to adolescence.

Modern lifestyle inputs many various environmental impulses in the physical and motor development of a child. These impulses mostly have a negative connotation. The lack of movement is one of the fundamental factors at the beginning of the spiral motor/sport inactivity model (Pišot and Šimunič, 2008). It is the first part in the chain of health hazard factors that leads to overweight and further on to the decline of motor competences. The decline of motor competences is the reason for irrational movement that leads to increased consumption of energy and faster fatigue. Preliminary factors lead to low motor self-image and consequently to bad physical self-image. Poor bodily self-image has an important effect on the quality of life,

leading to decreased social activities. The decline in social activities is one of the most important causes of the decrease of general motor sport activity. The mentioned factors are lined in a spiral model and also in different sequence, but they persistently and effectively deviate an individual in childhood from an activity that is necessary for harmonised development. Within this spiral model, two factors are key to a coordinated motor development of an individual: the increase of the quantity of total PA and within the latter, mastering motor competences. Appropriate motor competences can be acquired only by a child who gets not only an appropriate amount of PA, but also quality of motor experiences in early developmental period. These experiences guarantee the mastering of motor knowledge and the development of motor abilities that represent the fundamental factors of motor competence.

Some recent researches that were performed in different parts of the world by Walkley, Armstrong and Clohesy (1998), NSW Department of Health (2003) and Harrington (2005), found that the development of FMP in children is not harmonised or is unsatisfactory. Appropriate development of FMP is necessary for a healthy and safe lifelong physical and motor development, i.e. motor efficiency (Hands, 2002; Šimunič, Volmut and Pišot, 2010). Without appropriate motor competences, the motor challenges in the environment are limited and often present an irresolvable problem to an individual. Thus, the number of injuries of children due to falls from different heights is increasing (Ball, 2002). The results of the Report on the injuries of children and youngsters in Slovenia (Rok Simon, 2007) show that falls from various objects from different heights (chair, table, stairs, play tools etc.) in Slovenia present the fourth reason for deaths of children and also for more than half (52.7%) of hospitalisations of pre-school children due to injuries. Herrewegen and Molenbroek (2005) report that 2400 children in the Netherlands per year require medical care due to injuries at climbing. The number of skeletal injuries, inflammatory and degenerative diseases of the bones and joints as well as spinal diseases and injuries that are greatly connected to inactive lifestyle, has been concerningly increasing in the recent period (Bilban and Djomba, 2007; Gasparini, 2012).

Motor patterns that have not been learned or were wrongly learned in childhood, have an impact on inappropriate or irregular PA in adulthood. The results of researches also emphasise that motor self-image and trust in

motor abilities is a lifelong process that does not only affect motor habits and patterns but the entire educational field of man. Quite too often older children who are subjected to scientific research, encounter many problems that are principally the consequence of inappropriate motor development in early childhood. This results in the fact that scientific and research work should be applied to younger children and developmental processes should be studied in the earliest childhood period (Pišot and Šimunič, 2005). Gallahue and Ozmun (1998) emphasise that the FMP assessment is necessary at least for three reasons: establishing the global impact of lifestyle changes, the possibility to increase motor competences and the possibility of their upgrade – motor learning.

The process of development and learning FMP therefore demands their monitoring, analysis, assessment and comparison with the development of physical features and the development of motor skills. Early childhood period, especially from four to six years of age, is very important age-related developmental milestones. In this period, children enter the fundamental motor level (Gallahue, Ozmun and Goodway, 2011), which involves a typical expressive progress in the development of fundamental motor structures and the structure of the zone of motor skills (Pišot and Planinšec, 2005), while body growth is continued and already passes the first period of most expressive increase in body height and mass.

With a view to understand and examine the mechanisms involved in the development, execution and adaptation of fundamental motor patterns, in our extensive research we opted to longitudinally monitor developmental changes in physical characteristics and the functional motor abilities required to carry out elementary fundamental motor patterns in early childhood.

Methods

The research data were collected within the scope of the national fundamental project J5-2397 entitled "Analysis of Fundamental Motor Patterns, Skeletal and Muscular Adaptation to Specific Sedentary Lifestyle Factors in Children Aged 4 – 7 Years", which was implemented from 2009 to 2011. The project was financed by the Slovenian Research Agency and obtained the permit of the National Medical Ethics Committee. The project was executed by the Institute for Kinesiology Research (IKARUS)

that operates within the scope of the University of Primorska, Science and Research Centre (UP SRC).

Sample of participants in measurements

The sample of participants in measurements comprised children from the Koper, Semedela and Škofije kindergartens, born in 2005. There were 570 children invited to the research and the children whose parents provided a preliminary consent were included in the study. The measurements were executed on the same sample of children for three consecutive years (2009, 2010 and 2011), i. e. at the age of 4, 5 and 6. 107 4-year-old children (52 boys and 55 girls), 99 5-year-old children (48 boys and 51 girls) and 91 6-year-old children (44 boys and 49 girls) participated in measurements.

Sample of variables

The sample of variables in the research is comprised of data of measuring anthropometric and morphological features, static strength tests, movement coordination motor tests, muscle activation tests and speed as well as coordination of selected fundamental motor patterns. Data on motor habits of families participating in the research were acquired by surveys and semi-structure interviews.

The fundamental motor pattern analysis comprises of two sets of variables, i.e.:

- quantitative – time/space and
- qualitative – movement coherency variable.

The coordination of FMP was determined with a qualitative description based on the following variables of movement description: coherence of movement, observation of the direction of movement, the use of support or grip and the use of diagonal reciprocal motor pattern. On the scale of criteria from 1 (poor) to 3 (excellent), we prepared a 12-point scale of general movement coordination by considering four descriptive variables, i.e.: non-coordinated movement (4–6 points), partially coordinated movement (7–9 points) and coordinated movement – coherent FMP (10–12 points)

Table 1: The descriptive variables criteria of the coordination of implementation of FMP

NAME OF VARIABLE	NUMBER OF POINTS
COHERENCE OF MOVEMENT	
Moves incoherently and halts	1
Moves moderately coherently	2
Moves excellently coherently	3
OBSERVATION OF THE DIRECTION OF MOVEMENT	
Mostly observes the floor, hands and legs, occasionally the floor or direction of climbing (glances around the room)	1
Observes only hands and legs, occasionally the direction of climbing; observes the direction of climbing, occasionally looks at hands and legs	2
Only observes the direction of climbing	3
PUSH OFF – SUPPORT – GRIP	
Mostly uses under-grip, fork-grip or full grip, uses other parts of the body	1
Uses under- and over-grip, fork-grip or full grip	2
Mostly uses over-grip and fork grip	3
USE OF DIAGONAL RECIPROCAL MOTOR PATTERN	
Never – occasionally	1
Sometimes	2
Often – always	3
TOTAL POINTS	4-12

INVITED LECTURES
POZVANA PREDAVANJA

Progress and organisation of measurements

Measurements in 2009 and 2010 were implemented at the premises of the UP SRC IKARUS at the Valdoltra Orthopaedic Hospital and in 2011 in the premises of the UP SRC IKARUS at the Koper Secondary School of Technology. Measurements were executed in November, December and January.

In one day, children performed the following measurements in different sequences:

- measurement of anthropometric and morphological features,
- measurement of selected static strength parameters,
- measurement of the height of jump with and without the use of hands

on the tensiometric plate,

- measurement of time/space and dynamical parameters during walking and running on the treadmill,
- measurement of balance parameters during standing on the pressure plate,
- measurement of motor climbing and crawling tasks,
- measurement of whole body coordination motor tests,
- measurement of the Achilles tendon volume and stiffness with ultrasound and

• measurement of time/space parameters and muscle activation parameters during walking, running, jumping. The selected children performed the mentioned measurements during crawling and climbing the wall bars.

The content of measurements ("Play in the space") was adapted to the age of children. At arrival, children got paper rockets, on which they put star stickers after a successfully implemented task. At the end of measurements, each child received a symbolic gift.

Results and discussion

The three-year longitudinal study consisted in monitoring a set of selected FMP from the point of view of fundamental control and management mechanisms as well as the parameters of quality and consistency in the execution of FMP as fundamental motor structures. Changes to the selected criteria were detected in all FMP that were subject to monitoring and reveal a trend of connectedness between the FMP, which was expected from the point of view of development conditionality. Certain specifics that can be detected in the implementation of some FMP in early childhood are particularly interesting, especially in those instances where there is unexpected and uncoordinated implementation, resulting in deviations from certain findings in previous research. The effect of today's inactive lifestyle, which further inhibits the coordinated implementation of FMP and, consequently, motor development, is apparent.

The results section of this study consists in a more detailed presentation of the results of the fundamental motor pattern of climbing. The time of climbing in all three climbing tasks decreases with age ($p < 0.001$). At the age of 4, boys were faster at climbing in the first two climbing tasks, while at the age of 6, girls were faster in all the climbing tasks, but the differences do not achieve

the threshold of statistical significance. Up to the age of 6 there is a significant decline in children who are unable to perform the tasks, whether because of insufficient strength or fear of heights (Graph 1). Children aged between 4 and 5 showed an improvement by 29.5%, 33.3% and 27% in the selected climbing tasks CLIMB 90° 15 cm, CLIMB 90° 30 cm and CLIMB 90° 45 cm.

Graph 1: Graphical presentation of the time of climbing of 4–6 years old children at chosen climbing tasks

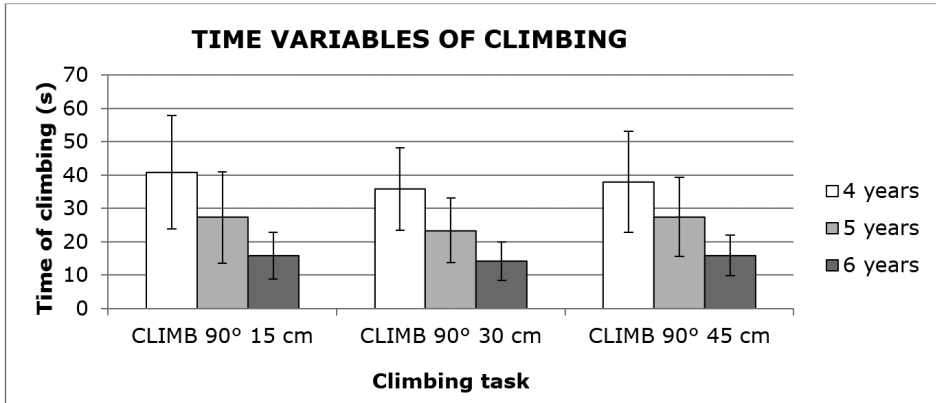

Coordination of movement in the climbing task CLIMB 90° 15 cm increases between the ages of 4 and 6. In the group of 4-year-olds, 7.9% show coordination in climbing, while the percentage increases to 21.6% in 5-year-olds and 22.3% in 6-year-olds. At the age of 6, the percentage of children in a coordinated manner is similar to that of 5-year-olds, while the percentage of children who climb in a coordinated manner and achieve the grade S2 (7- 9 points) (Graph 2).

Graph 2: Graphical presentation of coordination groups for climbing tasks CLI 90° 15 cm at the age of 4 to 6 years

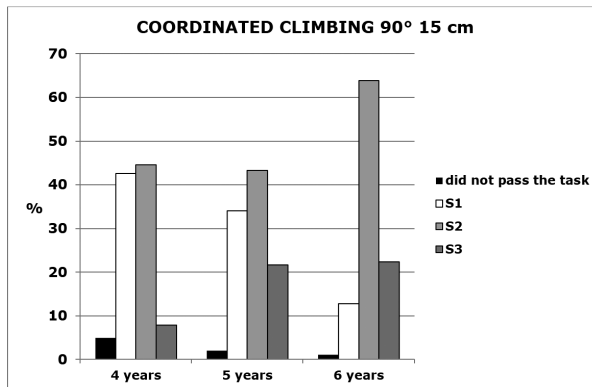

INVITED LECTURES
POZVANA PREDAVANJA

The time of climbing for climbing task CLIMB 90° 15 cm is statistically significantly different in the coordination groups for the aforementioned task in all three age groups. The children in the coordination group S3 were the fastest, while the slowest children were in the coordination group S1 (Graph 3).

Graph 3: Graphical presentation of the ratio between the time of climbing and the coordination groups for climbing task CLIMB 90° 15 cm

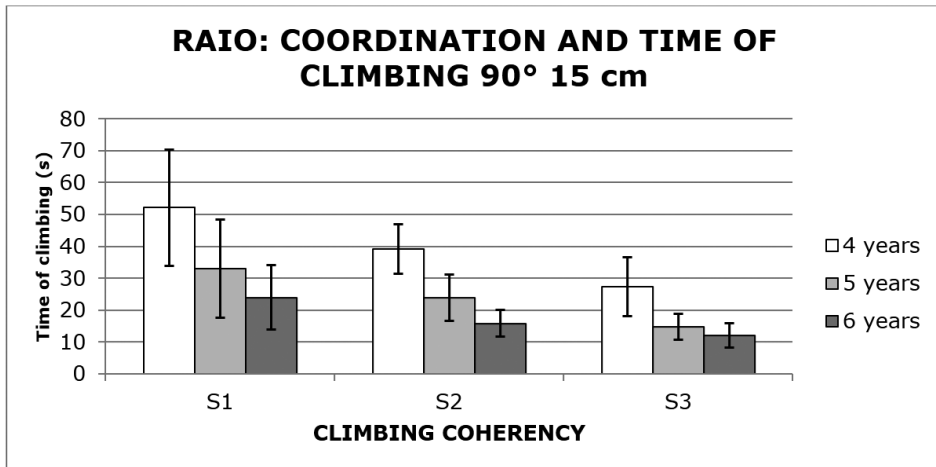

The time of climbing is statistically typically negatively connected with the coordination variables of climbing in all three years (Table 2).

Table 2: Connection of time variables of climbing with the variables of coordinated climbing

	Coordination of climbing 90° 15 cm 4 YEARS	Coordination of climbing 90° 15 cm 5 YEARS	Coordination of climbing 90° 15 cm 6 YEARS
CLIMB 90° 15 cm 4 YEARS	-.713***	-.238*	-.285**
CLIMB 90° 15 cm 5 YEARS	-.344**	-.753***	-.366**
CLIMB 90° 15 cm 6 YEARS	-.417**	-.346**	-.664***

*** p < 0.001; ** p < 0.01; * p < 0.05

Plevnik, Šimunič and Pišot (2014) have found that the climbing FMP are not related to the moderate and vigorous PA (MVPA) in 4-year-old children.

INVITED LECTURES
POZVANA PREDAVANJA

While the quantity of PA in the area of the MVPA was not connected with the time of climbing in test tasks of climbing CLIMB 90° 15 cm and CLIMB 90° 30 cm, the time of climbing was statistically typically connected with children's body height, their muscle mass and the rhythm of climbing as the descriptive variable of the climbing technique.

Climbing experience, acquired in an environment where there are many possibilities to climb, impacts the progress during climbing. Plevnik, Marušič and Pišot (2012) have found that the coordination in climbing the test task CLIMB 90° 15 cm statistically typically improved in 6-year-old children who were included in the motor activities programme with an increased quantity of climbing activities three times a week for 20 minutes during a one-month period.

Table 3: Average climbing times of children climbing on a specially adapted, 275 cm high wall bar (M ± SD)

	Initial measurements	Final measurements	% of progress
Time needed to climb up the wall bar (s)	4,89 ± 1,57	4,19 ± 1,11	14,3
Time needed to climb down the wall bar (s)	6,13 ± 2,05	4,69 ± 1,27	23,48
Total time (s)	11,03 ± 3,3	8,89 ± 1,9	18

Table 4: Average descriptive assessment of the performance of climbing tasks (M ± SD)

	Initial measurements	Final measurements
Descriptive assessment of climbing (points)	9,2 ± 1,7	11,4 ± 0,8

As part of the study, a survey was conducted, which included 24 children under the age of 6 (14 boys and 10 girls) who were given a climbing test at an interval of one month. Following a series of warm-up exercises, the children individually approached the wall bar and performed the test, after being given a sign by the person in charge of performing the measurement. The same protocol was applied for the final climbing measurements. Two variables were identified: the time of climbing as a quantitative assessment and a descriptive

assessment of climbing as a qualitative variable. For a period of one month, the children followed an adapted climbing program 3 times a week for 20 minutes during their regular physical education class. The exercises were performed by three rows of children simultaneously and the objective was to touch the top of the wall bar and then return to the back of the row. In the meantime, the children carried out various exercises involving elementary forms of movement. Example of a task: the subject starts from the row, jumps using only the left foot, lays on the stomach, climbs up the wall bar, climbs down the wall bar, lays on the stomach, jumps using only the right foot, returns to the back of the row. Over a period of one month, the children improved their time needed to climb up the wall bar by 14.3%, while the time needed to climb down the wall bar decreased by 23.5%. The total climbing time, which is the sum of the time needed to climb up the wall bar and the time needed to climb down the wall bar, was improved by 18 percent (Table 3). The rate of success in performing the climbing task based on a 12-point scale of descriptive criteria increased from the initial value of 9.2 points to 11.4 points (Table 4) after a 1-month period of exercise. The results of the aforementioned sub-study reflect the importance of non-formal learning in everyday activities.

Numerous studies (Ulrich, 1985; Wrotniak, Epstein, Dorn, Jones & Kindilis, 2006; Okely, Booth & Patterson, 2006; Stodden et al., 2008; Williams et al., 2008) prove important positive connections between the harmony of movement (better coordination, higher level of motor knowledge/information) and intensity of movement in younger children and adolescents. The results show that those with a higher level of motor knowledge (proficiency) are more often present in sports and spend more time on physical/sports activity per week. What is especially interesting is how this is positively connected with performing more physical/sports activities in adolescence. Research, where the occurrence and characteristics of fundamental motor patterns were studied, has shown that children with more coordinated movement (high coherence) are faster and more efficient (Pišot et al, 2012). These children are better at climbing (Plevnik & Pišot, 2011), crawling (Čeklić, Plevnik & Pišot, 2011) and jumping (Koren & Šimunič, 2012). The connection between monitored motor patterns (walking, jumping, climbing, crawling) is greater in those children whose fundamental motor patterns are more coordinated (Marušič & Pišot, 2012). Children with more knowledge and motor information (better motor memory) and more experience are more involved and have greater interest in being involved in physical/sports activities in adolescence (Malina, 2008).

Another interesting fact is that if we frequently offer a child incentive, he or she will learn harmonised fundamental movements extremely fast and efficiently (Plevnik, Geržević & Pišot, 2012).

Conclusion

Motor activity strongly contributes to the compensation of impacts of inappropriate, stressful lifestyle and excessive as well as unhealthy food of humans in today's modern sedentary society. It is true that the quantity of motor activities in everyday lives of the average man who achieves the appropriate level of energy consumption and compensation, is decreasing. It is important to engage systemic measures which will guarantee each individual from child to an elderly in time, space and with required means sufficient possibilities for a more active spending of work and free time. It is extremely important and, on the basis of findings of the latest research we could conclude that it is urgent that we further examine the quality of offered physical/sports contents and incentives in order to achieve sustainable impacts and consequences.

The role and meaning of motor knowledge, motor abilities (motor competences) and the impact of learned motor programmes on the efficiency of implementation of motor tasks was studied on a pattern of kids, adult and elderly subjects. However, the role of FMP was often not sufficiently acknowledged in these studies. FMP as fundamental motor structures that are phylogenetically conditioned and that have defined humans for hundreds of millennia, are a basis for motor development and motor learning and further on, the various motor stereotypes and disciplines that an individual will learn and master throughout his or her lifetime. Therefore, it is extremely important to understand the mechanisms behind FMP, in order to be able to introduce the necessary adaptations to the environment and create the incentives required to help a child develop these vitally important factors of development. In this respect, today's living environment and lifestyle are decidedly impeding factors and this can lead to irreparable damage to the child and the adolescent as well as the adult later on. The everyday motor experiences and incentives that were a common fixture of daily life in all social environments and activities not so long ago, from early childhood through to old age, are disappearing and being replaced by various and numerous forms sedentary activity. In order to preserve the fundamental factors that define humans as an exceptional species, an organism that is capable of reasoning (cognition), socializing and interpersonal communication (social activities), the motor skills that are

unique to our species (mobility) are of key importance, as they define our place in our habitat in our everyday chores, work and leisure activities. Therefore, natural motor incentives in the form of informal learning are critical as early as in early development, when movement and the most fundamental FMP are still being mastered, as we learn about ourselves and the world that surrounds us. FMP often have a decisive influence on the acquisition of phylogenetically and later on, ontogenetically conditioned types of movement as well as the development of basic and special motor abilities and motor skills, which are upgraded into motor competence - the basis of an individual's motor capital.

The goal of kinesiology, focusing in the optimisation of movement, is in the appropriate function of physiological systems that are responsible for control and implementation of movement. The demands of the complete approach to realising motor competence have to be individually conditioned and adapted to an individual with regards to his/her needs, abilities and goals, therefore, it is impossible to systemically unify them. Every period during lifespan – formation, functioning and decline of motor competences has a specific influence on different changes (Pišot, 2013). Knowing and understanding them, we can predict and solve the problems as well as programmed appropriate interventions, exercise and training.

References

Ball, D. J. (2002). Playgrounds – risk, benefits and choices (Research report). London: Middlesex University, School of Health in Social Sciences.

Bilban, M. in Djomba, J. K. (2007). Zdravstveni absentizem in boleznj gibal [Health absence and the locomotor system injuries]. *Delo+varnost*, 52(5), 10–19.

Gallahue, D. L. in Ozmun, J. C. (1998). Understanding motor development: Infants, children, adolescents, adults. Boston: McGraw-Hill.

Gallahue, D. L., Ozmun, J. C. in Goodway, J. (2011). Understanding motor development: infants, children, adolescents, adults. New York: McGraw-Hill Higher Education, London: McGraw-Hill.

Gasparini, M. (2012). Interdisciplinarna obravnava vloge in pomena gibalnega razvoja otroka kot naložbe za zdravo staranje [Interdisciplinary proceedings of the role and meaning of child's motor development as investment for healthy ageing]. Unpublished paper.

Hands, B. (2002). How can we best measure fundamental movement skills? Indiana (USA): University of Notre Dame, School of Health and Physical Education, College of Health.

Harrington, G. (2005). Fundamental motor skills (Research report). Tasmania: Deputy Secretary (Education), Department of Education, Community and Cultural Development.

Haywood, K. in Getchell, N. (2009). Life span motor development, 5th Edition. Champaign, IL: Human Kinetics Publishers.

Herrewegen, J. in Molenbroek, J. (2005). Children`s climbing skills (Research report). Amsterdam: Jep Design.

Malina, R. M., Bouchard, C. in Bar-Or, O. (2004). Growth, maturation, and physical activity. Champaign, IL: Human Kinetics.

NSW Department of Health. (2003). 'Move It, Groove It - Physical Activity in Primary Schools' (Research report). Sydney: NSW Department of Health.

Okely, A. D. in Booth, M. L. (2004). Mastery of fundamental movement skills among children in New South Wales: prevalence and sociodemographic distribution. *Journal of Science and Medicine in Sport*, 7, 358–372.

Pišot, R. (2012). Lifelong competency model of motor development. *Kinesiologia Slovenica*, 18(3), 35-46.

Pišot, R. in Planinšec, J. (2005). Struktura motorike v zgodnjem otroštvu: motorične sposobnosti v zgodnjem otroštvu v interakciji z ostalimi dimenzijami psihosomatičnega statusa otroka [Motor structure and basic movement competences in early child development]. Koper: University of Primorska, Science and Research Centre, institute for Kinesiology Research: Univerity Press Annales.

Pišot, R. in Šimunič, B. (2008). Spremljanje upada gibalnih sposobnosti šolskih otrok [Monitoring the decline of motor abilities among school children]. V A. Krulec (ed.), *Z gibanjem in prehrano do zdravja v vrtcu: zbornik predavanj 3. Mednarodnega strokovnega posveta organizatorjev prehrane in zdravstveno higienskega režima Slovenije*, 6.–7. november 2008. Ljubljana: Inštitut za sanitarno inženirstvo.

Pišot, R. in Šimunič, B. (2013). Force of gravity – basis of human motor competencies. V D. Madić (ed.). *3rd International Scientific Conference Exercise and Quality of Life: proceedings*, Novi Sad, April 12/13th 2013 (p. 49-62). Novi Sad: University of Novi Sad, Faculty of Sport and Physical Education..

Pišot, R., Plevnik, M., Mohorko, N., Pišot, S. Marušič, U. in Šimunič, B. (2012). Fundamental motor patterns in the context of motor competences acquisition: competence oriented motor development. In M. Andrijašević in D. Jurakić (ed.).

Međunarodna znanstveno-stručna konferencija Odgojni i zdravstveni aspekti sporta i rekreacije: zbornik radova, Križevci, 31. Ožujka 2012 (p. 60–75). Zagreb: Sveučilište, Kineziološki fakultet; Križevci: Zajednica sportskih udruga.

Pišot, R., Šimunič, B., Šarabon, N., Cankar, G., Jelovčan, G., Plevnik, M., idr. (2010). Gibalno kompetentan otrok – zdrav in uspešen otrok [Motor competent child – a healthy and successful child]. V J. Dolinšek (ed.), *Otrok in šport, Obravnava otrok z drisko, Šokovna stanja v otroškem obdobju / XX. srečanje pediatrov in VII. Srečanje medicinskih sester v pediatriji*, 16. in 17. aprila 2010, Maribor. (p. 15–26). Maribor: Univerzitetni klinični center.

Playday. (2007). *Our streets too!* National Children's Bureau: Department for Culture, Media and Sport.

Plevnik, M. (2011). Fundamental motor patterns in kindergarten. V D. Milovanovič in G. Sporiš (ed.), *Proceedings book of 6th International Scientific Conference on Kinesiology* (str. 297–299). Zagreb: University of Zagreb, Faculty of Kinesiology.

Plevnik, M., Marušič, U. in Pišot, R. (2012). Ocenjevanje elementarnega gibalnega vzorca plezanja v obdobju zgodnjega otroštva [Assessment of fundamental movement pattern of climbing in the period of early childhood]. In R. Pišot et al. (ed), *Otrok v gibanju za zdravo staranje / 7. mednarodni znanstveni strokovni simpozij Otrok v gibanju*, Koper, 2012 (p. 142–146). Koper: University of Primorska, Science and Research Centre, institute for Kinesiology Research: Univerity Press Annales..

Plevnik, M., Šimunič, B. in Pišot, R. (2014). The Assessment of Climbing Skill in Four-Year-Old Children. *Croatian Journal of Education*, 16(3), 677-697.

Rajtmajer, D. (1997). Diagnostično-prognostična vloga norm nekaterih motoričnih sposobnosti pri mlajših otrocih [Diagnostic and prognostic role of variables for some motor abilities]. Maribor: Faculty of Education.

Rok Simon, M. (2007): Poškodbe otrok in mladostnikov v Sloveniji: analiza podatkov o umrljivosti in obolevnosti [Injuries of children and youth in Slovenia: data analysis] (Research report). Ljubljana: Nacionalni inštitut za javno zdravje RS.

Stodden, D. F., Goodway, J. D., Langendorfer, S. J., Robertson, M. A., Rudisill, M. E., Garcia, C. in Garcia, L. E. (2008). A Developmental Perspective on the Role of Motor Skill Competence in Physical Activity: An Emergent Relationship. *Quest*, 60(2), 290–306.

Šimunič, B., Volmut, T. in Pišot, R. (2010). Otroci potrebujejo gibanje. Otrok med vplivi sodobnega življenjskega sloga – gibalne sposobnosti, telesne

značilnosti in zdravstveni status slovenskih otrok [Children need movement. The child between the influences of modern lifestyle – motor abilities, physical characteristics and health status of Slovenian children]. Koper: University of Primorska, Science and Research Centre, Institute for Kinesiology Research: University Press Annales.

Škof, B. (2010). Spravimo se v gibanje – za zdravje in srečo gre. Kako do boljše telesne zmogljivosti slovenske mladine? [Let's get move – for health and happiness. How to reach better physical efficiency of Slovenian youth?] Ljubljana: University of Ljubljana, Faculty of Sport, Institute of Sport, Centre for life learning in sport.

Videmšek, M. in Pišot, R. (2007). Šport za najmlajše [Sport for the youngsters]. Ljubljana: Faculty of Sport, Institute of Sport.

Walkley, J., Armstrong, D. in Clohesy, P. (1998). Fundamental Motor Skills: An Activities Resource for Classroom Teachers. Department of Education, Melbourne.

SECTION CONTEMPORARY SPORT ISSUES
SEKCIJA PROBLEMI SUVREMENOG SPORTA

INVITED LECTURES
POZIVANA PREDAVANJA

Keynote speaker

A new perspectives in muscle physiology (new knowledge and results from TMG studies)

Boštjan ŠIMUNIČ

*University of Primorska, Science and Research Centre, Institute for Kinesiology
Research, Koper, Slovenia*

A significant contribution to the field of muscle physiology has been made by introducing Tensiomyography (TMG) back in 1990 (Valenčič, 1990). TMG is a simple to use, selective and non-invasive method for detecting skeletal muscle contractile parameters using the linear displacement sensor. It measures skeletal muscle thickening and low frequency lateral oscillations of active skeletal muscle fibres during twitch isometric contraction. By the origin of measured signals it has been listed in the group of mechanomyographic (MMG) methods. Several MMG methods have been developed so far, for instance: in phonomyography or soundmyography or acoustic myography microphones are used to transform muscle fibre mechanical oscillations at its resonance frequency into audible sound, while in vibromyography accelerometers and laser beams are used to detect thickening and vibration of the entire muscle belly. Promising results have been obtained using MMG methods, but there are several difficulties, such as a low signal to noise ratio and consequently high variability, complex measuring setup and/or expensive hardware and necessary post-processing of signals; however, by using the displacement sensor TMG overcomes those limitations.

After its first scientific publication in 1990 several publications proofed its validity and reliability and identified two parameters of interest that clearly contributes to the new perspectives in muscle physiology. Contraction time is an indirect measure of a muscle composition while the response amplitude is a measure of muscle tone – an early measure of muscle atrophic or hypertrophic processes that could not be detected in anatomical level and standard clinical tools. By observing those two parameters, several studies were performed and new findings were well accepted. We have developed a model for non-

invasive indirect estimation of myosin heavy chain I in vastus lateralis (Šimunič et al., 2011) and we have demonstrated that the maximal response amplitude is directly linked to the loss of muscle diameter (Pišot et al., 2008) and even more interestingly it provides us with a detailed information about the muscle specific recovery after physical inactivity that was never observed so far (Šimunič et al., 2012).

Šimunič et al. (2011) used multiple linear regression to model myosin heavy chain I proportion (MHC-I) using three TMG-derived predictors: contraction time (Tc), delay time (Td) and half relaxation time (Tr) of the TMG twitch response and found a significant multiple correlation ($R = 0.933$) with regression model $MHC-I [\%] = 2.829 \cdot Td + 2.980 \cdot Tc + 0.127 \cdot Tr - 121.023$, with standard error of approx. 6.08 % and within-day, between-day and inter-rater reliability higher than 0.88 (Šimunič, 2012).

Eventhough already in 2008 Pišot et al. (2008) found that maximal displacement/amplitude (Dm, in millimetres) of the TMG twitch response is negatively correlated ($r = -0.70$) to muscle thickness loss after 35-day bed rest. This indicated that higher the atrophy (lower muscle thickness or CSA), higher the Dm increase. Furthermore, we measured muscle thickness (using ultrasound) and maximal TMG displacement during 35-day bed rest and found nonlinear relationship between both adaptations. Tensiomyographic amplitude increased very rapidly already after the first day of bed rest and plateau after the 28th day of bed rest. Different results were found in muscle thickness, which decreased after the sixth day of bed rest with the following linear decrease during 35-day bed rest. During the recovery period that followed, similar principles were confirmed: a higher rate in TMG amplitude recovery than in muscle thickness (Šimunič et al., 2012).

Even though TMG was widely used for studying muscle composition change, muscle atrophy/hypertrophy dynamics, adaptations to different pathologies (injuries, spasm), adaptations to specific training; and assessment of muscle fatigue, we recently discovered that TMG parameters are correlated to intrinsic muscle fiber properties (diameter, contractile force and unloaded velocity) while torque twitch parameters were not (Koren, 2015). That clearly positions TMG as a non-invasive indirect measure of intrinsic skeletal muscle contractile properties. Further studies will proof the validity of those results and confirm the theory.

The non-invasiveness and selectiveness with simplicity are three most important advantages of TMG. It was applied in children, athletes and

patients and it could give us an opportunity to increase the research power of established findings without major ethical drawbacks. TMG is relatively new method that needs further exploration of its potential. One of them will surely be in diagnostics by normalising TMG to electromyographic amplitude to establish electromechanical muscle efficiency. Even more, Đorđević et al. (2011) pointed out another future direction in the development of tensiomyography. In the newly developed methodology MC (muscle contraction) method they proposed the sensor to assess dynamic muscle contractions. The proposed MC method measures the force on the subject's skin above the skeletal muscle as a result of changed muscle contractile tension.

Literature

Đorđević S, Stančin S, Meglič A, Milutinović V, & Tomažič S. (2011). MC sensor-a novel method for measurement of muscle tension. *Sensors (Basel)*, 11(10), 9411–25.

Koren K. (2015). Biomechanical and geometrical adaptation of skeletal muscle and its muscle fibers on 14-day bed rest and active rehabilitation in elderly subjects: PhD dissertation.

Pišot R, Narici MV, Šimunič B, De Boer M, Seynnes O, Jurdana M, Biolo G, Mekjavić IB. Whole muscle contractile parameters and thickness loss during 35-day bed rest. *Eur. J. Appl. Physiol.* 2008;104(2):409–14.

Šimunič B, Degens H, Rittweger J, Narici MV, Mekjavić IB, Pišot R. Noninvasive estimation of myosin heavy chain composition in human skeletal muscle. *Med. Sci. Sports Exer.* 2011;43(9):1619–25.

Šimunič B. Between-day reliability of a method for non-invasive estimation of muscle composition. *J. Electromyogr. Kinesiol.* 2012;22(4):527–30.

Šimunič B, Degens H, Rittweger J, Narici MV, Pišot V, Mekjavić IB, Pišot R. Tensiomyographic measurement of atrophy related processes during bed rest and recovery. *Proceedings of Life in Space for Life on Earth*, Editors: Ouwehand L, ESA Communications, 2012.

Valenčič V. Direct measurement of the skeletal muscle tonus. In Popović D., editor. *Advances in external control of human extremities*. Beograd: Nauka. 1990:102–8.

Ekspertna procjena važnosti funkcionalnih energetskih mehanizama u rukometu

Marino Krespi, Nedim Šišić, Sanja Milat

Kineziološki fakultet u Splitu, Hrvatska

ABSTRACT

The aim of this study was to expert assessment by questionnaire establishes the importance of individual functional energy mechanisms at handball seniors. The study was conducted on a sample of 8 handball experts who have many years of work experience and are recognized handball conditioning coaches, handball coaches and teachers with a degree in kinesiology and orientation of this profession. The experts answered the four questions in the field of aerobic and anaerobic capacity in handball seniors. The calculated results are descriptive analysis, reliability analysis CA and IIR, and Spearman coefficient of rank correlation. Results of this study showed low values of the reliability of the questionnaire, and insignificant to high statistically significant correlation coefficients between experts. Spearman rank correlation coefficients were obtained by the low correlation between aerobic and anaerobic capacity. In new studies, it is necessary to make a model of a questionnaire that will be reliable and involve a larger number of questions for the purposes of determining the importance of functional energy mechanisms at handball seniors.

Keywords: experts, seniors, questionnaire, capacity and handball.

UVOD

Mnogi su sportski znanstvenici opisali rukomet kao vrlo zahtjevan sport sa tehničko- taktičkog, psihološkog, ali i motoričko-funkcionalnog gledišta (Skarbalius, 2011; Stanković i sur., 2011; Manchado i sur., 2007). Sa stanovišta strukturalne složenosti rukomet pripada najkompleksnijim sportskim aktivnostima – timskim sportskim igrama s loptom. Ova se kompleksnost

očituje u interakcijama igrača istog tima ali i suprotstavljenih timova tijekom pojedinih faza igre a u kojima se izmjenjuju brzinsko-eksplozivne aktivnosti različitih intenziteta (Michalsik i sur., 2011).

U istraživanju (Chelly i sur., 2011) navode kako je rukomet naizmjenično visoko-intenzivan kontaktni timski sport koji zahtjeva kombinaciju aerobne i anaerobne izdržljivosti kako bi se izvodile sekvence koordiniranih i složenih motoričkih aktivnosti. Dakle, rukometna je izvedba ovisna o mogućnosti igrača da naizmjenično ponavlja brzinske, eksplozivne, snažne i agilne kretnje i aktivnosti u visokom intenzitetu tijekom cijele utakmice, a ne o kapacitetu igrača da zadržava nepromijenjen submaksimalni intenzitet koji se ogleda isključivo u maksimalnom primitku kisika (VO₂max).

Testiranje izdržljivosti u rukometu moguće je provesti laboratorijskim ali i terenskim testovima (Sekulić i Metikoš, 2007). Trenažna je praksa pokazala kako su terenski testovi prikladniji, pouzdaniji i učinkovitiji u procjeni izdržljivosti zbog specifičnije simulacije natjecateljskog opterećenja. U svezi s time, (Kildin i sur., 2006) navode kako je primjerenije koristiti protokole za procjenu izdržljivosti u timskim sportovima naizmjeničnih aktivnosti visokog intenziteta, koji repliciraju kretne strukture pojedinog sporta.

Jedan od načina kojim se može izvršiti procjena važnosti funkcionalnih energetske mehanizama u sportovima jeste ekspertnom procjenom tijekom koje ekspert (kondicijski trener, trener), shodno svojim znanjima i praktičnim iskustvima rangira važnost pojedinih funkcionalnih energetske mehanizama u ovom slučaju u rukometu.

Na takvoj će se procjeni temeljiti i ovo istraživanje čiji je cilj ekspertnom procjenom utvrditi važnost pojedinih funkcionalnih energetske mehanizama kod rukometaša seniora.

METODE

Uzorak ispitanika za ovo istraživanje činilo je 8 rukometnih eksperata. Svi eksperti imaju dugogodišnje iskustvo u radu sa rukometašima i priznati su rukometni kondicijski treneri, rukometni treneri i profesori kineziologije s rukometnim usmjerenjem. Svi eksperti su bili upoznati sa svim detaljima upitnika i konačnim ciljem ovog istraživanja.

Upitnik su u ovoj studiji činila 4 pitanja o važnosti aerobnih i anaerobnih kapaciteta kod rukometaša seniora, a to su: „ 1. Koliko smatrate da je aerobni kapacitet važan kod rukometaša?“, „ 2. Koliko smatrate da je anaerobni alaktatni

kapacitet važan kod rukometaša? (Atp i CP)“; „ 3. Koliko smatrate da je anaerobni laktatni kapacitet važan kod rukometaša? (glikoliza)“; „ 4. Koliko smatrate da je kombinacija aerobnih i anaerobnih kapaciteta važna kod rukometaša?“.

Važnost pojedinih kapaciteta kod rukometaša seniora procijenjena je od strane eksperata putem ocjena na petostupanjskoj Likertovoj skali za svako pitanje na način: ocjena 5 – U najvećoj mjeri je važan, ocjena 4 – Vrlo je važan, ocjena 3 – Prosječno je važan, ocjena 2 – U manjoj mjeri je važan, ocjena 1 – Uopće nije važan.

Nakon preliminarnih statističkih procedura: aritmetička sredina (AS), standardna devijacija (SD), minimalni (Min) i maksimalni (Max) rezultati, mjere asimetričnosti distribucije (Skewness) i mjere izduženosti distribucije (Kurtosis), normalitet distribucije je utvrđen K-S testom. Granična vrijednost K-S testa za pojedinu veličinu uzorka nalazi se na dnu tablice. Među-čestičnim koeficijentom korelacije (IIR) i Cronbach Alpha koeficijentom pouzdanosti (CA) utvrdila se pouzdanost rezultata eksperata. Za utvrđivanje povezanosti između varijabli aerobnih i anaerobnih kapaciteta koristio se Spearmanov koeficijent rang interkorelacije. Ista analiza se koristila i za utvrđivanje povezanosti između eksperata. Primijenjena je 95% razina statističke značajnosti. Korišteni softverski program za obradu podataka u ovom istraživanju je STATISTICA (StatSoft, Tulsa, OK) verzija 12.6.

REZULTATI

Izračunati su osnovni deskriptivni parametri: aritmetička sredina, minimum i maksimum rezultata, standardna devijacija, te koeficijenti asimetričnosti i spljoštenosti distribucije (Tablica 2).

Tablica 1. Rezultati anketnih upitnika ispunjeni od strane rukometnih eksperata (EKS – Ekspert)

VARIJABLE	EKS 1	EKS 2	EKS 3	EKS 4	EKS 5	EKS 6	EKS 7	EKS 8
AERKAP	4	3	5	4	2	4	3	4
ANALKP	5	3	4	5	5	4	5	5
ANLAKP	4	4	4	4	3	5	5	4
AEANKP	5	5	4	5	3	5	4	4

Legenda: AERKAP – aerobni kapaciteti; ANALKP – anaerobni alaktatni kapaciteti; ANLAKP – anaerobni laktatni kapaciteti; AEANKP – kombinacija aerobnih i anaerobnih kapaciteta

Vrijednosti K-S testa ukazuju na normalnu distribuciju podataka, izuzev varijable ANALKP.

Daljnjom analizom rezultata asimetričnosti i zakrivljenosti distribucija nisu utvrđena neka značajna odstupanja u varijablama i može se reći da se kreću u granicama prihvatljivosti.

Analizama pouzdanosti dobivene su niske vrijednosti Cronbach alpha koeficijenta, te koeficijenta među-čestične korelacije za sve varijable funkcionalnih energetske mehanizama (Tablica 2).

Tablica 2. Deskriptivna analiza i parametri pouzdanosti varijabli (Min – minimalni rezultati; Max – maksimalni rezultati; AS – aritmetička sredina; SD – standardna devijacija; Skewness – mjere asimetričnosti distribucije; Kurtosis – mjere izduženosti distribucije; K-S – kolmogorov-smirnovljev test; CA – Cronbach Alpha; IIR – među-čestična korelacija.)

VARIJABLE	Min	Max	AS	SD	Skewness	Kurtosis	K-S	CA	IIR
AERKAP	2.00	5.00	3.63	0.92	-0.49	0.42	0.28		
ANALKP	3.00	5.00	4.50	0.76	-1.32	0.88	0.37		
ANLAKP	3.00	5.00	4.13	0.64	-0.07	0.74	0.32		
AEANKP	3.00	5.00	4.38	0.74	-0.82	-0.15	0.30	0.56	0.34

Granična vrijednost K-S testa je značajna na razini od 0.05 za $d > 0.34$ kada je $(N=8)$

Primjenom Spermanovog koeficijenta ranga interkorelacije dobiveni su niski negativni (od -0.17 do -0.35) i pozitivni koeficijenti (0.21 – 0.37) povezanosti između varijabli različitih funkcionalnih energetske mehanizama (Tablica 3).

Tablica 3. Spearmanov koeficijent rang interkorelacije između varijabli aerobnih i anaerobnih kapaciteta u rukometu

VARIJABLE	AERKAP	ANALKP	ANLAKP	AEANKP
AERKAP	1.00	-0.17	0.21	0.29*
ANALKP		1.00	-0.20	-0.35*
ANLAKP			1.00	0.37*
AEANKP				1.00

Analizom Spearmanovog koeficijenta ranga interkorelacije između eksperata može se utvrditi da je potpuna pozitivna povezanost ili najbolja korelacija prema ocjenama o važnosti funkcionalnih energetske mehanizama

kod rukometaša dobivena između eksperta 1 i 4. Nulta povezanost pokazala se između eksperata 1 i 6, 2 i 5, 4 i 6, 5 i 6, što znači da se rezultati (ocjene) varijabli jednog eksperta u paru kreću sasvim nezavisno od rezultata varijabli drugog eksperta u istom paru (Tablica 4).

Tablica 4. Spearmanov koeficijent rang interkorelacije između eksperata

EKSPERTI	1	2	3	4	5	6	7	8
1	1.00	0.24	-0.58	1.00	0.71	0.00	0.24	0.58
2		1.00	-0.54	0.24	0.00	0.94	0.06	-0.54
3			1.00	-0.58	-0.82	-0.58	-0.82	-0.33
4				1.00	0.71	0.00	0.24	0.58
5					1.00	0.00	0.83	0.82
6						1.00	0.24	-0.58
7							1.00	0.54
8								1.00

RASPRAVA I ZAKLJUČAK

Prema rezultatima aritmetičke sredine ocjena eksperata, evidentno je da sve analizirane varijable imaju iznad prosječnu važnost funkcionalnih energetske mehanizama u rukometu kod rukometaša seniora. Uvidom u rezultate deskriptivne analize, varijabla anaerobno alaktatni kapaciteti je dobila najveću ocjenu prema rezultatima aritmetičke sredine. Anaerobno alaktatni sustav ima mali kapacitet odnosno malu ukupnu količinu dostupne energije, ali zato isto tako ima i najveći energetske tempo odnosno najveću brzinu oslobađanja energije. Prema mišljenju autora, anaerobne alaktatne u odnosu na ostale sposobnosti su najvažnije u rukometu. Jedan od glavnih razloga je što se u skoro svakoj fazi završnog dijela akcije (napada) sve događa unutar nekoliko sekundi. Cilj napadača je da u što kraćoj jedinici vremena pokuša napraviti neku vrstu varke tijelom ili na neki način izbaciti protivnika iz ravnoteže, te postići pogodak. Da bi to uspio ostvariti od izuzetne važnosti je potrebno da ima jako dobru razvijenu brzinu reakcije (reaktibilnost). Isto to važi i za obrambenog igrača, gdje isti treba što prije i brže reagirati i ne dozvoliti prolaz protivničkom igraču do vratara. Sve ove radnje se događaju u jako kratkom vremenskom rasponu gdje lopta odmah ide na suprotnu stranu i zbog toga ne dolazi do velike akumulacije laktata. Koliko god da su ostale

funkcionalne sposobnosti maksimalno razvijene, igrač ukoliko nema dovoljno razvijene anaerobno alaktatne sposobnosti neće biti u mogućnosti da zavara protivnika u napadu ili zaustavi pravovremeno protivnika u obrani. Najmanji prosječan rezultat dobiven je u varijabli aerobni kapaciteti.

Rezultati pouzdanosti ukazuju na to kako nije prisutna zadovoljavajuća povezanost u odgovorima eksperata za sve varijable. Međutim, evidentan je nedostatak radova koji proučavaju problematiku važnosti aerobnih i anaerobnih kapaciteta kod rukometaša. Koliko je autorima poznato ovo je prvi rad u kojem se obrađuje ovakva problematika u rukometu, pa se prema tome ne može izvršiti usporedba vrijednosti koeficijenta Cronbach alphe i međučestične korelacije sa rezultatima istraživanja drugih autora.

Eksperti 1 i 4 imaju ista mišljenja (zaokružili su iste odgovore) o važnosti funkcionalnih energetske mehanizama kod rukometaša u svim varijablama.

Nulte povezanosti između eksperata ukazuju na nepostojanje bilo kakve korelativne veze između promatranih eksperata. Međutim, iz matrice korelacije može se vidjeti da ekspert pod brojem 3 ima najveće negativne korelacije u prosjeku u odnosu na druge eksperte. Ovaj ekspert je u najmanjoj povezanosti, odnosno najslabije korelira sa ostalim ekspertima.

Sukladno dobivenim rezultatima moguće je zaključiti da bi se ovakav model za utvrđivanje značajnosti funkcionalnih energetske mehanizama kod rukometaša seniora trebao modificirati u smislu da se obuhvati veći broj eksperata u ovakvoj studiji, zatim da se poveća broj pitanja o važnosti aerobnih i anaerobnih kapaciteta kod rukometaša seniora. Autori ove studije svjesni su relativno malog uzorka eksperata na kojem je testiranje provedeno, ali s obzirom da je ovo jedno od rijetkih istraživanja koje se bavi ovakvom problematikom u rukometu, u budućim istraživanjima bi za što objektivnije rezultate glavni preduvjet trebao biti homogen uzorak eksperata. U narednim istraživanjima treba voditi računa i o tome da se napravi model upitnika koji se može koristiti za potrebe utvrđivanja važnosti funkcionalnih energetske mehanizama kod rukometaša.

LITERATURA

Chelly, M. S., Hermassi, S., Aouadi, R., Khalifa, R., Van den Tillaar, R., Chamari, K., & Shephard, R. J. (2011). Match analysis of elite adolescent team handball players. *J Strength Cond Res*, 25(9), 2410-2417. doi: 10.1519/JSC.0b013e3182030e43

Kilding, A. E., Aziz, A. R., & Teh, K. C. (2006). Measuring and predicting maximal aerobic power in international-level intermittent sport athletes. *J Sports Med Phys Fitness*, 46(3), 366-372.

Manchado, C., Hoffmann, E., Valdivielso, F. N., & Platen, P. (2007). Stress profile in the women's handball load duration and heart rate behavior at national team matches. *Dtz Sportmed*, 58(10), 368.

Michalsik, L.B., Aagaard, P., & Madsen, K. (2011). Match performance and physiological capacity of male elite team handball players. *Science and Analytical Expertise in Handball*, Vol. 16, 168-173.

Sekulić D., & Metikoš D. (2007). *Fundamentals of transformation processes in kinesiology*. The textbook, page 162.

Skarbalius, A. (2011). Monitoring Sport Performance In Handball. *Science and Analytical Expertise in Handball*, Vol. 15, 325-330.

Stanković, V., Malacko, J., & Doder, D. (2011). Comparative analysis of latent structures of variables of pathological connate characteristics in case of handball players belonging to different competition ranks. *Acta Kinesiologica*, 5(2), 58-62.

Analiza razlika u rezultatima specijalnog judo fitness testa kod judašica različite natjecateljske uspješnosti

Marino Tavra, Goran Kuvačić, Saša Krstulović

Kineziološki fakultet, Sveučilište u Splitu, Hrvatska

ABSTRACT

The aim of this study was to determine and to interpret the possible differences between more and less successful youth female judoka based on the results in SJFT (special judo fitness test). The study was conducted on a fourteen Croatian judokas, at average chronological age of 18.4 ± 1.3 years. All of them are active competitors, weight categories ranging from -52 to +78. Judokas were divided into two experimental groups regarding to their competitive success. Statistically significant difference was found in the total number of throws, the number of throws in the first and third interval, and SJFT index. More successful judoka have better anaerobic glycolytic (lactate) system (statistically significantly greater number of throws), and also better ratio of aerobic and anaerobic capacity (significantly smaller SJFT index) versus less successful judoka. Recorded heart rate showed that intensity during test was very high. After examining the dynamics of lactate results, it can be concluded that the values obtained are similar to those in judo fight. The values of lactate in the last point of measurement (rest period) statistically significantly increased in comparison to the values immediately after the test was performed. In future studies would be desirable to the develop classification table for female judoka at different weight categories and age.

Key words: Special Judo Fitness Test, Lactate, Heart Rate, Intensity, Judo

UVOD

Judo borba se sastoji od razdoblja maksimalnog i sub-maksimalnog intenziteta opterećenja, s prosječnim trajanjem od 30sekundi rada koja se

odvijaju uz intervale odmora u trajanju od 10-ak sekundi. U ovim kratkim vremenskim intervalima nema dovoljno vremena za prikladnu resintezu ATP-a aerobnim sustavom, čime napori ovise o laktatnom anaerobnom kapacitetu judaša. S druge strane, aerobna komponenta pripremljenosti judaša se također smatra važnom, te dolazi do izražaja prilikom smanjenja koncentracije laktata u krvi nakon judo borbe (Franchini i sur. 2003). Procjena funkcionalnih kapaciteta judaša je vrlo bitna za trenajni proces, jer daje informacije parametrirane koje valja obratiti pozornost kako bi se unaprijedila učinkovitost aerobno-anaerobnog sustava (Sterkowicz i sur. 2001). Za procjenu stanja pripremljenosti judaša najčešće se koriste specifični testovi koji su po svojoj strukturi najbližiji judo borbi. Konstruirano je nekoliko testova koji analiziraju fiziološke i neuro-muskularne zahtjeve u judo borbi, s ciljem da se identificiraju efikasne metode u poboljšanju fizičke pripremljenosti judaša. Za potrebe ovog istraživanja koristiti će se tzv. „Special Judo Fitness Test“ (SJFT), koji je pregledom literature, zasigurno jedan od najčešće primijenjenih specifičnih judo testova u svijetu. Cilj ovog istraživanja je utvrditi i interpretirati moguće razlike između uspješnijih i manje uspješnih judašica juniorskog uzrasta na temelju rezultata SJFT-a.

METODE

Istraživanje je provedeno na uzorku od četrnaest hrvatskih judašica, prosječne kronološke dobi od $18,4 \pm 1,3$ godine. Sve ispitanice su aktivne natjecateljice, težinskih kategorija u rasponu od -52 do +78 kg.. Ispitanice su podijeljene u dvije eksperimentalne grupe obzirom na njihovu natjecateljsku uspješnost. Eksperimentalnu grupu A je sačinjavalo sedam uspješnijih judašica (osvajalice zlatnog odličja na juniorskom PH ili članice juniorske reprezentacije) a eksperimentalnu grupu B sedam manje uspješnih natjecateljica (sudionice ili osvajačice odličja na PH). Uzorak varijabli se sastojao od trinaest varijabli. Mjerenje, odnosno uzorkovanje koncentracije laktata iz krvi (LAC) u tri točke mjerenja (u mirovanju, neposredno nakon završetka testa i nakon pauze od 5 min.), srčana frekvencija (SF) u pet točaka mjerenja (prosječna vrijednost tijekom testa, najviša vrijednost tijekom testa, neposredno nakon završetka testa, nakon pauze od 1 i 5 min.), broj bacanja pri izvođenju testa u sva tri intervala rada, ukupan broj bacanja te izračunati indeks specijalnog judo fitness testa. Za očitavanje srčane frekvencije korišten je *Polar* uređaj. Laktati su mjereni Accutrend Lactate aparatom. Opis testa (Special Judo Fitness Test): Dva judaša, slične tjelesne mase izvođača testa (približno iste kategorije), nalaze se na šest

metara udaljenosti jedan od drugog, dok sam izvođač testa stoji u sredini. Test je podijeljen na tri intervala od 15 (A), 30 (B) i 30 (C) sekundi, s 10 sekundi odmora između svakog od njih. Tijekom svakog intervala rada, izvođač mora što je moguće više puta baciti nasuprotne judaše ručnom tehnikom ippon-seoi-nage, i to naizmjenično. Svi ispitanici nosili su pripadajuću opremu za izvođenje testa (kimono i pojas). Otkucaji srca se snimaju odmah po završetku testa i 1 minutu nakon završetka testa. Iz ukupnog broja bacanja kroz sva tri intervala izračunava se indeks izvedbe, pri čemu su HR0 i HR1 otkucaji srca odmah nakon, te 1 minutu po završetku testa, a Tt je ukupan broj bacanja. Test traje 1 minutu i 35 sekundi, a rezultat je indeks koji se izračunava formulom:

$$\text{INDEKS} = (\text{HR0} + \text{HR1}) / \text{Tt}$$

Što je indeks manji, to je bolji rezultat testa. Izračunati su deskriptivni statistički parametri, te t-test kojim se utvrdila razlika između dvije eksperimentalne grupe u svim varijablama.

REZULTATI

Tablica 1. Deskriptivni statistički parametri: aritmetička sredina (AS), standardna devijacija (SD) te Kolmogorov-Smirnovljev test (max D), uspješne judašice (A), manje uspješne judašice (B)

VARIJABLE	AS		SD		max D	
	A	B	A	B	A	B
TEŽINA	70,97	72,79	12,02	16,00	0,26	0,25
HR/ AVG	170,43	178,14	6,05	10,70	0,29	0,19
HR/ MAX	186,14	190,57	6,96	7,93	0,22	0,19
HR/ NAKON	186,00	187,86	7,14	10,29	0,21	0,12
HR/ 1MIN.	163,71	168,00	17,32	13,93	0,27	0,13
HR/ 5MIN.	120,43	121,71	10,61	17,80	0,16	0,19
LAC/ MIROVANJE	1,49	1,87	0,60	0,69	0,23	0,26
LAC/ NAKON	12,59	10,63	4,37	5,30	0,23	0,24
LAC/ 5MIN.	12,83	11,39	3,64	5,01	0,18	0,15
BR. BACANJA 1.INTERVAL	6,29	5,00	0,49	0,58	0,43	0,36
BR. BACANJA 2.INTERVAL	10,00	9,57	0,82	0,79	0,21	0,42
BR. BACANJA 3.INTERVAL	9,71	8,29	0,95	0,95	0,33	0,34
BACANJA SJFT	26,00	22,86	1,63	2,12	0,21	0,28
INDEKS SJFT	13,58	15,69	1,39	1,86	0,12	0,26

Granična vrijednost K-S testa za n=7 iznosi 0,48 p<0,05

Tablica 1 prikazuje deskriptivne statističke parametre primijenjenih varijabli kod dvaju sub-uzoraka judašica. Uočljivo da su sve varijable normalno distribuirane, te se može pristupiti daljnjoj obradi podataka.

Tablica 2. Rezultati t-testa za nezavisne uzorke: aritmetička sredina (AS), t-vrijednost (t), razina značajnosti (p), uspješne judašice (A), manje uspješne judašice (B).

VARIJABLE	AS		t	p
	A	B		
TEŽINA	70,97	72,79	-0,24	0,81
HR/ AVG	170,43	178,14	-1,66	0,12
HR/ MAX	186,14	190,57	-1,11	0,29
HR/ NAKON	186,00	187,86	-0,39	0,70
HR/ 1MIN.	163,71	168,00	-0,51	0,62
HR/ 5MIN.	120,43	121,71	-0,16	0,87
LAC/ MIROVANJE	1,49	1,87	-1,12	0,29
LAC/ NAKON	12,59	10,63	0,75	0,47
LAC/ 5MIN.	12,83	11,39	0,62	0,55
BR. BACANJA 1.INTERVAL	6,29	5,00	4,50	0,00*
BR. BACANJA 2.INTERVAL	10,00	9,57	1,00	0,34
BR. BACANJA 3.INTERVAL	9,71	8,29	2,81	0,02*
Bacanja SJFT	26,00	22,86	3,11	0,01*
Indeks SJFT	13,58	15,69	-2,40	0,03*

*statistička značajnost na razini $p < 0,05$

Tablica 2 prikazuje rezultate t-testaza sve varijable kod dvaju sub-uzoraka judašica. Vidljivo je da se grupe statistički značajno razlikuju u broju bacanja u 1. intervalu, broju bacanja u 3. intervalu, u ukupnom broju bacanja, i u indeksu SJFT.

RASPRAVA

Prosječne vrijednosti srčanih frekvencija kod svih 5 varijabli ukazuju da je test bio visokog intenziteta (HR/avg,max,nakon,1min,5min), te su prosječne vrijednosti niže kod uspješnijih judašica u odnosu na manje uspješne. McArde i sur. (2001), navode da bolje trenirani sportaši imaju niže vrijednosti srčane

frekvencije od lošije treniranih sportaša pri jednakom fizičkom opterećenju. U istraživanju Almansba i sur. (2007), također su zabilježene veće vrijednosti srčanih frekvencija kod sub-elitnih judaša naspram elitnih judaša pri izvođenju specifičnog judo testa, što ukazuje na važnost srčano-žilne izdržljivosti u judu. Prosječna vrijednost srčane frekvencije nakon testa iznosi 186 otk/min kod uspješnijih te 187,76 otk/min kod manje uspješnih judašica, što je slično rezultatima dobivenih u istraživanju Wolska-Paczoska (2010) kod juniorki poljske reprezentacije, gdje su vrijednosti iznosile 181 otk/min. Prosječna vrijednost koncentracije laktata u mirovanju iznosi 1,49 mmol/L kod uspješnijih te 1,87 mmol/L kod manje uspješnih, što je u granicama normalnih vrijednosti. Uzorkovanjem laktata iz krvi u drugoj točki mjerenja, odnosno odmah po završetku testa, prosječne vrijednosti su iznosile 12,59 mmol/L kod uspješnijih te 10,63 mmol/L kod manje uspješnih judašica. U istraživanju Sterkowicza i sur. (1997), navodi se da koncentracija laktata u krvi nakon završene judo borbe iznosi 11.22 mmol/L, što je vrlo slično vrijednostima koje su dobivene u ovom istraživanju. Nadalje, broj bacanja pri izvedbi testa SJFT u ovom istraživanju je razmjerno visok, tako da je prosječna vrijednost broja bacanja kod uspješnijih judašica iznosila 26, što je slično rezultatima istraživanja koje su dobili Drid i sur. (2009) kod seniorki ženske srpske reprezentacije (28,1). Prosječna vrijednost broja bacanja kod manje uspješnih judašica iznosi 22,86, te je vrlo slična vrijednostima rezultata istraživanja koje je dobio Wolska-Paczoska (2010) kod juniorki poljske reprezentacije (22,1). Neočekivano, u ovom istraživanju koncentracija laktata u krvi raste i u oporavku. S obzirom da su uspješnije judašice reprezentativke, osvajačice medalja na međunarodnim natjecanjima i visoko utrenirane sportašice bilo je za očekivati da će koncentracija laktata u krvi imati trend opadanja, jer visoko utrenirani sportaši se bolje adaptiraju na uvjete koje uzrokuje rad visokog intenziteta (Daussin i sur. 2008). Slične rezultate u svom istraživanju dobili su Kuvačić i sur. (2013). Oni su mišljenja da se rast koncentracije laktata u krvi nakon 5 minuta od izvođenja testa, jednim dijelom može tumačiti kontroliranim uvjetima testa, za razliku od judo borbe, gdje borac sam diktira tempo i prilagođava se uvjetima borbe. Drugo moguće objašnjenje je i trajanje testa. Naime, ispitanici su morali odraditi maksimalni napor u svega 95 sekundi. Prema nekim autorima koncentracija laktata u krvi 5 minuta nakon intenzivnog i razmjerno kratkog vježbanja ne bi trebala opadati nego pokazivati svoje maksimalne vrijednosti (Zouhal i sur. 2007). Uspješnije judašice su izvršile statistički značajno više bacanja u prvom intervalu rada koji je bio trajanja petnaest sekundi. Tu je moguće vidjeti značaj anaerobnog

alaktatnog kapaciteta u kombinaciji sa laktatnim, koji je od presudne važnosti u judu, s obzirom da subrzina pokreta, promjene smjera i eksplozivna bacanja karakteristična za judo borbu. U 2. intervalu rada, kod judašica se nije utvrdila značajna razlika u broju bacanja, iako su uspješnije judašice imale u prosjeku veći broj bacanja. U 3. intervalu rada, uspješnije judašice su izvršile statistički značajno veći broj bacanja, što se može objasniti većim laktatnim glikolitičkim kapacitetom i njegovim bržim oporavkom za razliku od manje uspješnih judašica. U ovom istraživanju, uspješnije judašice su pokazale i da imaju bolje razvijen anaerobni glikolitički (laktatni) sustav (statistički značajno veći broj bacanja), te također bolji odnos aerobnog i anaerobnog kapaciteta (statistički značajno manji SJFT indeks) naspram manje uspješnih judašica. Dobiveni rezultati su slični rezultatima istraživanja Franchini i sur. (2005) u kojima su rezultati broja bacanja kod uspješnijih judaša značajno veći, a vrijednost SJFT indeksa značajno manja naspram manje uspješnih judaša.

ZAKLJUČAK

Cilj ovog istraživanja bio je utvrditi i interpretirati moguće razlike između uspješnijih i manje uspješnih judašica juniorskog uzrasta na temelju rezultata SJFT-a. U ovom istraživanju utvrđena je statistički značajna razlika između navedenih uzoraka ispitanica u ukupnom broju bacanja, broju bacanja u 1. i 3. Intervalu, te u indeksu SJFT. Uspješnije judašice su pokazale da imaju bolje razvijen anaerobni glikolitički (laktatni) sustav (statistički značajno veći broj bacanja), te također bolji odnos aerobnog i anaerobnog kapaciteta (statistički značajno manji SJFT indeks) naspram manje uspješnih judašica. To je pokazatelj da SJFT može uspješno razlikovati uspješnije od manje uspješnih judašica te može poslužiti kao dobar alat u dijagnosticiranju stanja kondicijske pripremljenosti judašica juniorske dobne kategorije u svrhu unaprjeđenja njihovog trenažnog procesa. Zabilježena srčana frekvencija pokazuje da je intenzitet rada za vrijeme testa bio vrlo visok. Uvidom u dinamiku laktata može se zaključiti da su dobivene vrijednosti približne onima u judo borbi. Vrijednosti laktata u zadnjoj točki mjerenja (odmoru) statistički značajno rastu u odnosu na mjerenje koje je napravljeno odmah nakon izvođenja testa. Takav rezultat može se pripisati kratkom trajanju testa i kontroliranim uvjetima u kojima je test izveden, za razliku od judo borbe koja ima daleko veću dinamiku pokreta. S obzirom na dobivene rezultate, bilo bi poželjno da se u budućim istraživanjima izradi klasifikacijska tablica za judašice različitih težinskih i dobnih kategorija u kojoj bi mogli klasificirati razinu kondicijske pripremljenosti judašicas obzirom

na dobivene rezultate SJFT, te na taj način kvalitetnije pratiti i ostvariti ciljeve s obzirom na njihovo stanje specifične kondicijske pripremljenosti.

LITERATURA

Almansba, R., Franchini, E., & Sterkowicz, S. (2007). An uchi-komi with load, a physiological approach of a new special judo test proposal. *Sci Sports*, 22(5), 216-223.

Daussin, F. N., Zoll, J., Ponsot, E., Dufour, S. P., Doutreleau, S., Lonsdorfer, E., & Richard, R. (2008). Training at high exercise intensity promotes qualitative adaptations of mitochondrial function in human skeletal muscle. *Journal of Applied Physiology*, 104(5), 1436-1441.

Drid, P., Maksimovic, N., Matic, R., Obradovic, B., Milosevic, Z., & Ostojic, S. M. (2009). Fitness profiles of elite female judokas of the Serbian national team. *Medicina dello Sport*, 62(3), 251-263.

Franchini, E., Yuri Takito, M., Yuzo Nakamura, F., Ayumi Matsushigue, K., & Peduti Dal Molin Kiss, M. A. (2003). Effects of recovery type after a judo combat on blood lactate removal and on performance in an intermittent anaerobic task. *Journal of sports medicine and physical fitness*, 43(4), 424-431.

Kuvačić, G., Krstulović, S., & Miletić, A. (2013). Dinamika laktata i glukoze pri izvođenju specifičnog judo testa. 22. ljetna škola kineziologa Republike Hrvatske.

McArdle, W. D., Katch, F. I., & Katch, V. L. (2010). *Exercise physiology: nutrition, energy, and human performance*. Lippincott Williams & Wilkins.

Sterkowicz, S., & Franchini, E. (2001). Specific Fitness of novice and elite judoists. *Journal of Human Kinetics*, 6, 81-98.

Sterkowicz, S., & Rukasz, W. (1997). Analysis of the Training of workload plan for judo competitors. Cracow Academy of Physical Education.

Wolska-Paczoska, B. (2010). The Level of Aerobic and Anaerobic Capacity and the Results of a Special Mobility Fitness Test of Female Judo Competitors Aged 16-18 Years. *Baltic Journal of Health and Physical Activity*, 2(2), 124-131.

Zouhal, H., Vincent, S., Moussa, E., Jacob, C., Groussard, C., Abderrahaman, A. B., & Prioux, P. (2007). Influence of training status on plasma volume variations and plasma lactate concentrations in response to supramaximal exercise. *Biology of Sport*, 24(4), 339.

Povezanost motoričko-funkcionalnih sposobnosti i uspjeha u judu kod judaša kadetske dobne skupine – mišljenje judo eksperata

Petra Đapić Caput¹, Saša Krstulović², Goran Kuvačić²,
Dragan Crnov³, Marino Tavra²

¹Judo klub „Dubrovnik“

²Kineziološki fakultet, Sveučilište u Splitu

³Judo klub „Solin“

ABSTRACT

For the purposes of this study two objectives were defined: to determine the order and importance of bio-motor abilities at judoka Cadet age using questionnaire due to weight class, and identification of differences in the results obtained through the questionnaire about the order and importance of bio-motor abilities on the success at judoka Cadet age groups due to weight class. Study was conducted on 40 European top judo experts from 22 European countries and questionnaire was constructed for evaluating the impacts of bio-motor abilities in judoka. Judokas were divided in lower weight class (-46 kg to 66 kg) and higher weight class (of 66 kg or more). Measuring scale for evaluation was 0-100. In lower categories speed, explosive strength and specific judo endurance are on first three places while the maximum strength and flexibility at the end. Moderate importance to success in judo have coordination, agility, balance and muscular endurance. On the other hand, in higher categories the most important abilities are maximum strength, specific judo endurance and muscular endurance, while the agility and flexibility are least important for success. Results of t-test between judoka lower and higher categories under paragraphs coach, indicate that there is a statistical difference in the four variables (agility, speed, coordination and maximum strength).

Key words: Bio-motor Abilities, Weight Class, Questionnaire, Success, Judo

UVOD

Koji čimbenici i u kojoj mjeri određuju uspjeh u judu i omogućuju postizanje vrhunskih rezultata? Odgovoriti na ovo pitanje nije jednostavno, jer je judo izuzetno kompleksan sport. Naime, natjecateljsku uspješnost određuje čitav niz osobina i sposobnosti, te tehničko-taktička izvedba, koja se realizira u izravnoj borbi sa protivnikom. Drugim riječima judo je sport s velikom fizičkom, tehničkom i taktičkom složenošću (Degoutte, i sur. 2003). Složenoj strukturi judo sporta pridonosi i podjela judaša u više težinskih kategorija, pa se tako pojedina kategorija razlikuje po svojoj tehničkoj i taktičkoj strukturi, kao i u fiziološkim zahtjevima i morfološkim karakteristikama (Drid i sur. 2012). Callister i sur. još su davne 1991. g. naglasili kako su faktori odgovorni za uspješnu izvedbu specifični za svaku pojedinu težinsku kategoriju. Međutim, od tog vremena do danas učestale promjene pravila borbe su u većoj ili manjoj mjeri uvjetovale i promjene u hijerarhiji i razini značaja pojedinih dimenzija na uspjeh u judu. Osobito su promjene nastale u posljednjih nekoliko godina, (primjerice zabrana primjene pojedinih hvatova i tehnika bacanja, smanjenje trajanja borbe za žene, itd.) značajno utjecale na stil i intenzitet borbe vrhunskih boraca, a time i na promjene značaja pojedinih faktora na uspjeh u borbi. Može se stoga zaključiti da je identifikacija sposobnosti bitnih za uspjeh u judu temelj za uspješno planiranje i programiranje trenažnog procesa. Do informacija o važnosti pojedinih sposobnosti na uspjeh u judu moguće je doći i putem upitnika primijenjenih na vrhunskim judo stručnjacima. Na temelju tih informacija svaki bi trener mogao ciljano u pojedinoj etapi treninga razvijati određene sposobnosti bitne za uspjeh. Dosadašnja istraživanja provedena putem testiranja sportaša nisu dala konačan odgovor na pitanja o odnosu utjecaja pojedine sposobnosti i o njihovoj važnosti i hijerarhiji na uspjeh u judu. Prema saznanjima autora, u novije vrijeme, provedena su samo dva istraživanja koja su primijenila anketne upitnike (Krstulović, 2012; Krstulović i Sekulić, 2013) s ciljem utvrđivanja hijerarhije i važnosti sposobnosti bitnih za uspjeh u judu. Sukladno tome, za ovo istraživanje definirana su dva cilja: utvrđivanje redosljeda i važnostimotoričko funkcionalnih sposobnosti judašakadetske dobne skupine putem anketnog upitnika s obzirom na težinsku kategoriju, te utvrđivanje razlika u rezultatima dobivenim putem anketnog upitnika o redosljedu i važnosti motoričko funkcionalnih sposobnosti na uspjeh judaša kadetske dobne skupine s obzirom na težinsku kategoriju.

METODE

Uzorak ispitanika predstavlja 40 europskih vrhunskih judo eksperata, izbornika i trenera iz 22 europske zemlje (10 trenera ima završen poslijediplomski studij, 6 trenera je sa završenom visokom školom, 18 trenera ima višu školu i 6 trenera ima status studenta. Konstruiran je mjerni instrument-upitnik za vrednovanje utjecaja motoričko-funkcionalnih sposobnosti judaša na uspjeh u judu kod dobne skupine kadeta obzirom na težinsku kategoriju. Uzorak ispitanika je podijeljen na kadete nižih težinskih skupina (-46 kg do 66 kg) i viših težinskih skupina (od 66 kg i više). Mjerna skala za vrednovanje iznosila je od 0 do 100. Trenerima se putem specijaliziranog servera ponudilo da postave po redoslijedu i važnosti motoričko funkcionalne sposobnosti koje su značajne za uspjeh u judu ovisno o težinskoj kategoriji: fleksibilnost (FLEK), agilnost (AG), koordinacija (KOO), ravnoteža (RAV), specifična judo izdržljivost (SPECIF), eksplozivna snaga (EKS), mišićna izdržljivost (IZD), maksimalna jakost (MAKS) i brzina (BRZ). U svrhu realizacije prvog cilja, utvrđeni su deskriptivni i distribucijski parametri za sub-uzorke judaša. U svrhu realizacije drugog cilja, primijenjen je t-test za nezavisne uzorke.

REZULTATI

Tablica 1. Deskriptivni pokazatelji varijabli redoslijeda i važnosti motoričko funkcionalnih sposobnosti upitnika za procjenu uspjeha u judu za judaše nižih i viših kategorija: aritmetička sredina (AS), standardna devijacija (SD), minimalni rezultat (MIN), maksimalni rezultat (MAX), koeficijent asimetrije (SKE), koeficijent spljoštenosti (KUR) i Kolmogorov – Smirnovljevi test (K-S).

VAR	NIŽE KATEGORIJE							VIŠE KATEGORIJE						
	AS	SD	MIN	MAX	SKE	KUR	K-S	AS	SD	MIN	MAX	SKE	KUR	K-S
SPECIF	78.23	13.95	50	100	-0.06	-0.82	0.12	78.70	14.09	50	100	-0.38	-0.33	0.13
AG	75.70	15.69	30	100	-0.77	0.37	0.20	63.13	19.00	20	90	-0.45	-0.83	0.19
BRZ	82.20	10.94	50	100	-0.58	0.79	0.19	72.08	14.02	40	100	-0.01	-0.71	0.15
EKS	78.67	12.79	50	100	-0.28	-0.73	0.16	76.93	14.35	40	100	-0.54	0.97	0.19
FLEK	61.73	16.92	30	100	0.12	-0.43	0.18	58.00	16.86	20	90	-0.02	-0.58	0.15
KOO	77.88	15.27	30	100	-0.92	1.40	0.17	70.63	16.45	20	100	-0.60	0.78	0.11
MAKS	63.63	17.17	30	100	-0.17	-0.42	0.14	81.73	11.70	60	100	0.06	-0.96	0.14
IZD	71.13	16.96	30	100	-0.78	0.15	0.17	77.63	12.14	50	100	-0.04	-0.60	0.14
RAV	71.70	21.46	20	100	-0.83	-0.01	0.15	70.38	19.82	20	100	-0.47	-0.35	0.13

Granična vrijednost K-S testa za n=40 iznosi 0,21 p<0,05

Tablica 1 prikazuje deskriptivne pokazatelje analiziranih varijabli motoričko-funkcionalnih sposobnosti, koji su dobiveni prema stavovima vrhunskih judo trenera kod judaša. Vrijednosti K-S testa za testiranje normaliteta distribucije kreću se od 0.11 do 0.20 i ispod su razine granične vrijednosti.

Tablica 2. Rezultati t-testa u motoričko-funkcionalnim sposobnostima između judaša nižih i viših kategorija: aritmetička sredina (AS), standardna devijacija (SD), Kolmogorov-Smirnovljev test (K-S), vrijednost t-testa (t test), razina značajnosti (P), značajna razlika na razini $p \leq 0.05$ (*)

VAR	NIŽE KATEGORIJE			VIŠE KATEGORIJE			t-test	P
	AS	±	SD	AS	±	SD		
SPECIF	78.23	±	13.95	78.70	±	14.09	-0.15	0.88
AG	75.70	±	15.69	63.13	±	19.00	3.23	0.00*
BRZ	82.20	±	10.94	72.08	±	14.02	3.60	0.00*
EKS	78.67	±	12.79	76.93	±	14.35	0.58	0.57
FLEK	61.73	±	16.92	58.00	±	16.86	0.99	0.33
KOO	77.88	±	15.27	70.63	±	16.45	2.04	0.04*
MAKS	63.63	±	17.17	81.73	±	11.70	-5.51	0.00*
IZD	71.13	±	16.96	77.63	±	12.14	-1.97	0.05
RAV	71.70	±	21.46	70.38	±	19.82	0.29	0.77

Uvidom u rezultate t testa (tablica 2) u stavovima trenera o redosljedu utjecaja motoričko-funkcionalnih sposobnosti na uspjeh u judo sportu između judaša nižih kategorija i judaša viših kategorija, može se primijetiti da se na razini značajnosti $p < 0.05$ statistički značajno razlikuju stavovi trenera u varijablama za procjenu agilnosti (t-test=3.23; $p \leq 0.01$), brzine (t-test=3.60; $p \leq 0.01$), koordinacije (t-test=2.04; $p \leq 0.05$) i maksimalne jakosti (t-test=-5.51; $p \leq 0.01$).

RASPRAVA

Promatrajući srednje vrijednosti važnosti ponuđenih dimenzija na uspjeh u judu, uočava se možda i najvažnija činjenica ovog dijela istraživanja. Naime, primjetne su izuzetno male razlike između prve i posljednje dimenzije bitne za uspjeh u judu (prosječne vrijednosti rezultata kreću se uglavnom u vrijednostima od 60 – 100). Takvi rezultati sugeriraju da praktički sve motoričko-funkcionalne sposobnosti imaju značajan utjecaj na uspjeh u judu, te da nema značajnih razlika u važnosti između njih bez obzira na spol i težinsku

kategoriju. Kod judaša nižih kategorija vidi se kako su brzina, eksplozivna snaga i specifična judo izdržljivost najvažnije za uspjeh u judu prema stavovima judo trenera. Franchini i sur. (2013) navode kako je judo sport u kojem prevladavaju aktivnosti visokog intenziteta te su za natjecateljsku uspješnost i optimalan tehničko taktički razvoj potrebne mnoge sposobnosti. Visoko pozicionirane brzina i eksplozivna snaga vjerojatno su dijelom uzrokovane promjenama pravila koja su između ostalog imala za cilj smanjiti pasivnost, odnosno povećati aktivnost-atraktivnost u judo borbi. U istraživanju Hernández-García i sur. (2009) autori su došli do zaključka kako se dolaskom novih pravila broj i trajanje pauza u judo borbi smanjuje, a ujedno se povećava aktivnost u borbi što rezultira velikim fiziološkim zahtjevima u judo borbi. Nova pravila su nekadašnju nerijetko pasivnu i statičnu borbu koja se odvijala u nadmudrivanju protivnika kroz primanje i raskidanje garda, dovela da se judaši (osobito u nižim težinskim kategorijama) brže kreću po strunjači, a tehnike se izvode češće i eksplozivnije. Nakon što judaš primi gard, izvođenje tehnika bacanja zahtijeva eksplozivne reakcije u trajanju od 1.0-1.4s, u kojoj su uključene donje i gornje mišićne skupine (Marconi sur., 2010). Monteiro i sur. 2014. godine navode kako je cilj judaša prilikom izvođenja tehnika bacanja spustiti centar težišta što niže i zadržati takav položaj dok se ne pripremi za eksplozivno izvođenje bacanja. Krstulović i sur. (2012) su u svom istraživanju zaključili kako su eksplozivna snaga i brzina najvažnije kod judaša nižih kategorija. Očekivani rezultati dobiveni su kod judaša viših kategorija gdje maksimalna jakost zauzima prvo mjesto, a slijede je specifična judo izdržljivost i mišićna izdržljivost. Za razliku od nižih kategorija kod kojih se dolaskom novih pravila „ubrerala“ judo borba, u višim kategorijama još uvijek dominira maksimalna jakost. Prema, Sterkowicz i sur. (2011) i Bonitch-Góngora i sur. (2012), važno mjesto u pripremi judaša zauzima maksimalna jakost jer ona omogućava držanje, kontrolu i dominaciju nad protivnikom kako bi se izvele tehnike u napadu sa krajnjim ciljem ostvarivanja pobjede. Međutim kako je već navedeno, potrebno je izbjeći pasivnu borbu, pa se tako uočava kako su u višim kategorijama pored maksimalne jakosti važne specifična judo izdržljivost i mišićna izdržljivost koje osiguravaju aktivnost i dominaciju judaša tijekom cijele borbe u kojoj su energetski zahtjevi izuzetno veliki. Također se primjećuje kako su vrhunski treneri odmah iza navedenih sposobnosti, rangirali upravo brzinu i eksplozivnu snagu koje značajno pridonose aktivnoj borbi a time u konačnici pobjedi. Analizirajući razlike u stavovima trenera ovisno o kategorijama dobivene su značajne razlike kod judaša nižih i viših kategorija. Naime, očito da anketirani treneri smatraju da

varijable agilnost, brzina i koordinacija više pridonose uspjehu kod muškaraca nižih kategorija, dok varijabla maksimalna jakost više pridonosi uspjehu kod muškaraca viših kategorija.

ZAKLJUČAK

Za potrebe ovog istraživanja definirana su dva cilja: utvrđivanje redoslijeda i važnostimotoričko funkcionalnih sposobnosti judaša kadetske dobne skupine putem anketnog upitnika s obzirom na težinsku kategoriju, te utvrđivanje razlika u rezultatima dobivenim putem anketnog upitnika o redoslijedu i važnosti motoričko funkcionalnih sposobnosti na uspjeh judaša kadetske dobne skupine s obzirom na težinsku kategoriju. Kod judaša nižih kategorija prema stavovima judo trenera brzina, eksplozivna snaga i specifična judo izdržljivost zauzimaju prva tri mjesta dok su maksimalna jakost i fleksibilnost najmanje bitni za uspjeh. Umjerenu važnost na uspjeh u judu imaju koordinacija, agilnost, ravnoteža i mišićna izdržljivost. S druge pak strane, kod judaša viših kategorija prema stavovima judo trenera najvažnije su maksimalna jakost, specifična judo izdržljivost i mišićnu izdržljivost, dok su agilnost i fleksibilnost najmanje bitne za uspjeh. Rezultati t-testa između judaša nižih i viših kategorija, ukazuju kako postoji statistički značajna razlika u četiri varijable (agilnost, brzina, koordinacija i maksimalna jakost).

LITERATURA

Bonitch-Góngora, J.G., Bonitch-Domínguez, J.G., Padial, P., Feriche, B. (2012). The effect of lactate concentration on the handgrip strength during judo bouts. *Journal of Strength and Conditioning Research*, 26(7), 1863-71.

Callister, R., Callister, R.J., Staron, R.S., Fleck, S.J., Tesch, P., Dudley, G.A. (1991). Physiological characteristics of elite judo athletes. *International Journal of Sports Medicine*, 12(2), 196-203.

Degoutte, F., Jouanel, P., Filaire, E. (2003). Energy demands during a judo match and recovery. *British Journal of Sports Medicine*, 37(3), 245-249.

Franchini, E., Artioli, G.G., Brito, C.J. (2013). Judo combat: Time-motion analysis and physiology. *International Journal of Performance Analysis in Sport*, 13(3), 624-641.

Hernández-García, R., Torres-Luque, G., Villaverde-Gutierrez, C. (2009). Physiological requirements of judo combat. *International SportMed Journal*, 10, (3), 145-151.

Krstulovic, S., Sekulic, D., (2013). Predictors of judo performance in female athletes – insights from 27 top-level European coaches – *Gazzetta Medica Italiana Archivio per le Scienze Mediche*, 172, (1-2), 35-42.

Krstulović, S. (2012). Predictors of judo performance in male athletes. *Homo Sparticus, Scientific journal of sport and physical education*, 42(2), 5-11.

Marcon, G., Franchini, E., Jardim, J.R., Neto, T.L.B. (2010). Structural analysis of action and time in sports: judo. *Journal of Quantitative Analysis in Sport*, 6(4), 1-13.

Monteiro, L.F., Massuca, L.M., Garcia-Garcia, J.M., Calvo-Rico, B. (2014). Differences of Explosive Strength in Judokas Medallists and Not Medallists. *Indian Journal of Research*, 3(5), 199-202.

Sterkowicz, S., Lech, G., Chwała, W., Ambroży, T., Jaworski, J. Kłys, A. (2011). Muscle strength in young judo contestants vs. untrained subjects. *Archives of Budo*, 7(3), 179-184.

Utjecaj motoričko-funkcionalnih sposobnosti na uspjeh kod judaša kadetske dobne kategorije

Goran Kuvačić¹, Petra Đapić Caput², Saša Krstulović¹

¹Kineziološki fakultet, Sveučilište u Splitu

²Judo klub „Dubrovnik“

ABSTRACT

In this research testing of bio-motor abilities was conducted in order to define the influence of bio-motor abilities judoka Cadet age group, and determine the linkage between results obtained by testing bio-motor abilities to the success judoka Cadet age due to the weight category. Cadet judokas were divided in two sub-groups. The first sub-group represents 22 judoka of lower weight categories, the average body weight of $62.35 \pm 6:51$ kg., and second sub-group represents 20 judoka of higher weight categories, the average body mass $83.78 \pm 13:33$ kg. Sample of variables represents nine tests for evaluating bio-motor abilities. In lower categories greatest influence on the criterion variable have agility ($\beta = -0.42$), speed ($\beta = -0.37$) and specific judo endurance, but not at the level of statistical significance. Furthermore, in higher categories greatest impact on the criterion variable have maximum strength ($\beta = 0.585$) and coordination ($\beta = -0.433$). Variables that are still included in the analysis were those for assessment of agility, speed, explosive strength and flexibility, but not at the level of significance.

Key words: Bio-motor Abilities, Weight Categories, Endurance, Judo

UVOD

Natjecateljsku uspješnost određuje čitav niz osobina i sposobnosti, psihički i energetski potencijal pojedinca te tehničko-taktička izvedba, koja se realizira u izravnoj borbi sa protivnikom. Fukuda i sur. (2011) naglašavaju

kako je trening juda metabolički zahtjevna aktivnost koja je povijesno bila povezana s tjelesnim odgojem i razvojem djece i mladeži. Poznajući vrijednosti juda i njegov svestrani utjecaj na cjelokupni antropološki status pojedinca pred trenerima su veliki izazovi u svakodnevnom radu, posebno kada se radi o postizanju vrhunskih rezultata. Judo je olimpijski sport sa velikom fizičkom, tehničkom i taktičkom složenošću (Degoutte i sur., 2003). Osnovao ga je Jigoro Kano 1882. u Japanu. Široki spektar judo tehnika dijeli se na osam skupina: tehnike stavova, tehnike kretanja, tehnike hvatova, tehnike padova, tehnike bacanja, tehnike poluga, tehnike gušenja i tehnike zahvata držanja. Sve tehnike juda izvode se u borbi sa protivnikom gdje su moguće mnogobrojne kombinacije bilo da se radi o obrani ili napadu odnosno o borbi u stojećem stavu ili parteru. U judu se treba voditi računa o činjenici da su judaši osim po spolu i dobnim skupinama podijeljeni i po težinskim kategorijama. Callister i sur. (1991) naglašavaju kako su faktori odgovorni za uspješnu izvedbu specifični za svaku pojedinu težinsku kategoriju. S ciljem izrade što kvalitetnijeg plana i programa, a u konačnici i postizanja vrhunskog rezultata, potrebno je provoditi istraživanja vezana uz određivanje hijerarhijske strukture čimbenika bitnih za uspjeh u judu te odnosa istih. Na taj se način omogućava dobivanje važnih spoznaja odgovornih za postizanje uspjeha. Treninge trebaju provoditi visokoobrazovani i stručni treneri kako trening ne bi imao negativne posljedice na razvoj pojedinca i na njegovu sportsku izvedbu (Oliver i sur., 2011). Glavni cilj ovog istraživanja je utvrđivanje utjecaja motoričko-funkcionalnih sposobnosti na uspjeh u judu kadetske dobne skupine putem testiranja motoričko-funkcionalnih sposobnosti s obzirom na težinsku kategoriju.

METODE

Uzorak ispitanika sačinjava 2 sub-uzorka judaša kadetske dobne skupine od 15 do 17 godina, kojeg između ostalih predstavljaju nositelji državnih medalja i medalja sa europskih kupova, te natjecatelji koji su nastupili na Europskom prvenstvu za kadete i kadetkinje. Prvi sub-uzorak predstavlja 22 judaša kadetske dobne skupine nižih težinskih kategorija, prosječne tjelesne mase 62.35 ± 6.51 kg. Drugi sub-uzorak predstavlja 20 judaša kadetske dobne skupine viših težinskih kategorija, prosječne tjelesne mase 83.78 ± 13.33 kg. Uzorak varijabli predstavljaju testovi (po jedan reprezentativni test) za procjenu pojedinih motoričko-funkcionalnih sposobnosti: 1) za procjenu fleksibilnosti -pretklon sunožno (FLEK), 2) za procjenu agilnosti -t test (AG), 3) za procjenu koordinacije -okretnost na tlu (KOO), 4) za procjenu ravnoteže

-stork test(RAV), 5) za procjenu specifične judo izdržljivosti -specifični judo fitness test (SPECIF), 6) za procjenu eksplozivne snage nogu -skok iz čučnja sa pripremom (EKS), 7) za procjenu mišićne izdržljivosti podizanje trupa iz ležanja (IZD), 8) za procjenu maksimalne jakosti - lat mašina 1 RM (MAKS), 9) za procjenu brzinskih sposobnosti -trčanje 30 m iz letećeg starta (BRZ). Kriterijska varijabla natjecateljske uspješnosti definirana je na temelju prikupljenih bodova koje su judaši ostvarili na kriterijskim natjecanjima za tekuću godinu, a koji su objavljenih u registru Hrvatskog judo saveza. Utvrđeni su deskriptivni i distribucijski parametri za oba sub-uzorka. Za potrebe utvrđivanja utjecaja motoričko-funkcionalnih sposobnosti na uspjeh u judu putem testiranja motoričko-funkcionalnih sposobnosti primijenjena je višestruka regresijska analiza sa korištenjem forward stepwise algoritma selekcije varijabli u regresijski model.

REZULTATI

Tablica 1. Deskriptivni pokazatelji testiranja motoričko funkcionalnih sposobnosti judaša nižih i judaša viših kategorija: aritmetička sredina (AS), standardna devijacija (SD), minimalni rezultat (MIN), maksimalni rezultat (MAX) i Kolmogorov – Smirnovljevi test (K-S).

VAR	NIŽE KATEGORIJE (n=22)					VIŠE KATEGORIJE (n=20)				
	AS	SD	MIN	MAX	K-S	AS	SD	MIN	MAX	K-S
SPECIF [#]	15.24	1.70	12.03	19.67	0.09	14.73	1.52	12.31	18.00	0.16
AG [#]	11.82	0.93	10.50	14.22	0.19	11.97	0.85	10.49	13.48	0.11
BRZ [#]	4.24	0.28	3.88	4.94	0.12	4.31	0.28	3.96	5.04	0.18
EKS	29.80	6.90	19.00	47.67	0.13	25.20	7.01	15.53	40.57	0.12
FLEK	34.29	9.27	17.67	51.33	0.12	37.90	7.32	21.33	49.00	0.11
KOO [#]	13.38	1.34	10.50	15.53	0.13	13.96	1.71	10.53	16.69	0.09
MAKS	59.77	11.90	40.00	80.00	0.15	70.50	8.87	55.00	90.00	0.13
IZD	60.14	6.20	41.00	70.00	0.18	56.70	5.68	41.00	66.00	0.15
RAV	4.59	2.20	1.67	9.46	0.21	4.04	1.95	1.86	7.88	0.27

Granična vrijednost K-S testa (za n=22 iznosi 0,21; za n=20 iznosi 0,29; p<0,05)

Analiza distribucije rezultata kod judaša nižih kategorija, putem Kolmogorov - Smirnovljevog testa za svaku izmjerenu varijablu potvrđuje da ne postoji značajna razlika distribucija rezultata navedenih varijabli u odnosu

na teorijski normalne distribucije rezultata na razini pogreške od 0.05. Za uzorak ispitanika - judaši viših kategorija, deskriptivni pokazatelji iz tablice 1. analiziranih varijabli motoričko funkcionalnih sposobnosti i vrijednosti K-S testa za testiranje normaliteta distribucije se kreću od 0.09 do 0.27i ispod su razine granične vrijednosti. Navedeni rezultati ukazuju kako sve promatrane varijable ne odstupaju značajno od normalne Gaussove distribucije, te se prikupljeni podaci mogu koristiti za daljnje statističke obrade

Tablica 2. Rezultati multiple regresijske analize i forward stepwise regresijske analize motoričko funkcionalnih sposobnosti bitnih za uspjeh kod judaša nižih i viših kategorija: multipla regresija (R), koeficijent determinacije (R²), standardizirana vrijednost regresijskog koeficijenta (β), standardizirana vrijednost regresijskog koeficijenta-Forward stepwise (β (FS)), razina značajnosti (p).

VAR	NIŽE KATEGORIJE		VIŠE KATEGORIJE	
	β	β (FS)	β	β (FS)
SPECIF [#]	-0.242	-0.262	-0.053	
AG [#]	-0.375	-0.419*	0.366	0.318
BRZ [#]	-0.339	-0.375*	0.419	0.443
EKS	0.005		0.352	0.345
FLEK	-0.029		0.257	0.269
KOO [#]	-0.155		-0.383	-0.433*
MAKS	0.003		0.598*	0.585**
IZD	0.055		0.079	
RAV	-0,287	-0.269	0.020	
	R-0.82*	R-0.81**	R-0.83 R-0.83** R ² - 0.70	
	R ² - 0.68	R ² -0.66	R ² -0.69	
	p< 0.05*	p< 0.01**	p< 0.05* p< 0.01**	

Kod nižih kategorija iz tablice 2 može se zaključiti kako kod primijenjenog modela multiple regresijske analize postoji statistički značajan utjecaj skupa motoričko funkcionalnih varijabli sposobnosti na kriterijsku varijablu uspješnosti. Međutim, parcijalno niti jedna primijenjena varijabla nema značajan utjecaj na uspjeh u judu. Primjenom forward stepwise regresijske analize koeficijent multiple korelacije za navedene varijable iznosi 0.82 te je statistički značajan na razini p<0.01. Najveći utjecaj na kriterijsku varijablu imaju

varijable za procjenu agilnosti ($\beta=-0.42$) i brzine ($\beta=-0.37$). Kod viših kategorija samo se modelom forward stepwise analize dobio statistički značajan utjecaj skupa prediktorskih varijabli na kriterij. Tako je primjenom navedenog modela koeficijent multiple korelacije za navedene varijable 0.83 ($p < 0.05$). U ovom modelu najveći utjecaj na kriterijsku varijablu imaju varijable za procjenu maksimalne jakosti ($\beta=0.585$) i koordinacije ($\beta=-0.43$).

RASPRAVA

Neke od rezultata deskriptivne statistike je moguće usporediti s istraživanjem Krstulović (2006) koji je uzorak kadeta također podijelio u dvije skupine; niže i više težinske kategorije. Uočava se kako su u navedenom istraživanju kadeti nižih težinskih kategorija imali u testu okretnost na tlu prosječnu vrijednost 11.77, a u podizanju trupa 50.28. U ovom istraživanju, prosječni rezultati kod judaša nižih kategorija u testu okretnost na tlu su lošiji i iznose 13.38, a rezultati podizanje trupabolji i iznose 60.14. Uspoređujući rezultate sa istraživanjem (Krstulović, 2006) uočava se kako kadeti viših težinskih kategorija imaju vrijednosti u testu okretnost na tlu 11.84, dok kadeti viših kategorija u ovom istraživanju imaju prosječne rezultate testa okretnost na tlu 13.96. Prosječne vrijednosti u rezultatima za procjenu mišićne izdržljivosti koje u navedenom istraživanju iznose 49.04, dok su u ovom istraživanju prosječne vrijednosti 56.70. Rezultati multiple regresijske analize, te forward stepwise regresijske analize sub-uzoraka ispitanika ukazuju na izrazito visoke numeričke vrijednosti regresijskih koeficijenata na globalnoj razini. Međutim, dobivena je veća statistička značajnost i viši parcijalni beta koeficijenti primjenom forward stepwise metode. Obzirom da se radi o razmjerno malom uzorku ispitanika koji je uz to podijeljen nadvije težinske skupine (judaši niže kategorije $n=22$, judaši više kategorije $n=20$), i obzirom na primijenjen razmjerno veliki broj motoričko-funkcionalnih testova bilo je sasvim očekivano da će metoda forward stepwise multiple regresijske analize dati interpretabilnije rezultate. Rezultati kod judaša nižih težinskih kategorija su pokazali kako značajan utjecaj na uspjeh u judu imaju brzina i agilnost. Navedene sposobnosti dolaze do izražaja u brzim kretanjima judaša po strunjači kako bi se pravovremeno primio dominantan gard i time ujedno brzo i efikasno izvela tehnika bacanja s krajnjim ciljem ostvarivanja pobjede. Također brze kretnje i promjene pravca kretanja pomažu kod oslobađanja od garda koji je nepovoljan da bi se izvelo bacanje ili kako bi se narušila protivnikova ravnoteža kao preduvjet za izvođenje novog bacanja. Na sub-uzorku judaša viših kategorija, sustav prediktorskih varijabli

objašnjava 69% ukupne varijance sustava, a multipla korelacija iznosi 0.83 primjenom forward stepwise regresijske analize. Najbolji prediktori natjecateljske efikasnosti kod judaša viših kategorija su maksimalna jakost i koordinacija koje su važne u borbi posebno kod primanja garda i kontrole protivnika u stojećem stavu i parteru. Visoka razina koordinacijskih sposobnosti je potrebna kako bi se u realizaciji kompleksnih tehničko taktičkih elemenata došlo do pobjede. Da bi realizacija kompleksnih tehnika bacanja bila uspješna od judaša se zahtjeva konstantno unaprjeđivanje tehnike i tehničko-taktičkih detalja raznih tehnika u stojećem stavu i parteru, ali i obrana od protivničkih akcija, zašto je potrebna neuro-muskularna koordinacija odnosno koordinacija gornjih i donjih ekstremiteta tijekom napada ili pak obrane (Sterkowiczisur 2012.). S obzirom da se radi o judašima koji su u dobi kad još uvijek nisu stekli potpunu tehničku stabilnost, važnost koordinacije je time još više izražena. Naime, poznato je da je visoka razina koordinacije potrebna kod učenja složenih tehnika juda, te da ona određuje način na koji se judaš bori, odnosno što je veća raznolikost tehnika u pojedinom sportu to je veća važnost koordinacije (Lech i sur. 2014). Visoka razina koordinacije posebno dolazi do izražaja u višim težinskim kategorijama gdje uz primjenu maksimalne jakosti koja omogućuje judašu dominaciju nad protivnikom, visoka razina koordinacijskih sposobnosti olakšava izvođenje tehnika juda u svim smjerovima.

ZAKLJUČAK

U ovom istraživanju provedeno je testiranje motoričko funkcionalnih sposobnosti kako bi se definirao utjecaj motoričko-funkcionalnih sposobnostiju daša kadetske dobne skupine na uspjeh judaša kadetske dobne skupine s obzirom na težinsku skupinu. Primjenom multiple regresijske analize i forward stepwise regresijske analize utvrdio se redoslijed i važnost utjecaja motoričko-funkcionalnih sposobnosti putem testiranja motoričko-funkcionalnih sposobnosti judaša kadetske dobne skupine u dvije težinske skupine. S obzirom na broj ispitanika i primijenjenih varijabli metoda forward stepwise regresijske analize se pokazala kao metodološki opravdanija metoda. Kod judaša nižih kategorija najveći utjecaj na kriterijsku varijablu imaju varijable za procjenu agilnosti i brzine, te varijabla za procjenu specifične judo izdržljivosti ali ne na razini statističke značajnosti. Nadalje, kod judaša viših kategorija najveći utjecaj na kriterijsku varijablu imaju varijable za procjenu maksimalne jakosti i koordinacije. Varijable koje su još uključene u analizi su one za procjenu agilnosti, brzine, eksplozivne snage i fleksibilnosti, ali ne na razini značajnosti.

LITRATURA

Callister, R., Callister, R.J., Staron, R.S., Fleck, S.J., Tesch, P., Dudley, G.A. (1991). Physiological characteristics of elite judo athletes. *International Journal of Sports Medicine*, 12(2), 196-203.

Degoutte, F., Jouanel, P., Filaire, E. (2003). Energy demands during a judo match and recovery. *British Journal of Sports Medicine*, 37(3), 245-249-78.

Franchini, E., Artioli, G.G., Brito, C.J. (2013). Judo combat: Time-motion analysis and physiology. *International Journal of Performance Analysis in Sport*, 13(3), 624-641.

Fukuda, D.H., Stout, J.R., Burris, P.M., Fukuda, R.S. (2011). Judo for children and adolescents: Benefits of combat sport. *Strength and Conditioning journal*, 33(6), 60-63.

Krstulović, S., F. Žuvela, R. Katić, (2006). Biomotor systems in elite junior judoka. *Collegium Antropologicum*, 30(4), 845-851.

Lech, G., Sertić, H., Sterkowicz, S., Sterkowicz-Przybycień, K., Jaworski, J., Krawczyk, R. (2014). Effects of different aspects of coordination. *Kinesiology*, 46(1), 69

Oliver, J.L., Lloyd, R.S., Meyers, R.W. (2011). Training elite child athletes: Promoting welfare and well-being. 33(4), 73-79.

Sterkowicz, S., Lech, G., Jaworski, J., Ambroży, T. (2012). Coordination motor abilities of judo contestants at different age. *Journal of Combat Sports & Martial Arts*, 3(2), 5.

Povezanost dimenzija slike o sebi i ekstenzitetu treninga u sportskom plesu

Noemi Zovko, Alen Miletić, Vedrana Grčić

Kineziološki fakultet, Sveučilište u Splitu, Hrvatska

ABSTRACT

Body image and self perception are important issue among sport dancers that effects planning of dance training. Interdisciplinary investigations are needed to understand better relations body image and various training factors. Training extensity is one of well known factors that influence success on dance competitions. The investigation was conducted in order to established relations between factors of Multidimensional Body Image Questionnaire and training extensity. The experiment comprised of 173 female sport dancers and 200 male sport dancers from 53 countries and six continents. The sample of variables was consisted of variables for estimation, latent dimensions obtained in investigation Miletić (2012): attractiveness, joy, body efficacy, flexibility, energy, strength, bad health/weakness and masculinity/femininity; and variables for estimation of training extensity. According to results obtained by discriminate analysis calculated separately by gender, the interrelations of factors of Multidimensional Body Image Questionnaire were defined among subsamples defined by training extensity with domination of flexibility and energy factors. Further investigations of age differences and training specifities are necessary for better understanding of obtained results

Key words: Standard and Latin dancers, gender differences, questionnaire

UVOD

Ples je složena kineziološka i društvena aktivnost koju je potrebno promatrati i analizirati interdisciplinarno. Proučavanje *slike o tijelu* kod plesača ima kineziološku, psihološku i umjetničku pozadinu. Cash i Pruzinisky (1990)

prema Cashmore (2008) definiraju sliku o tijelu kao unutarnje, subjektivne reprezentacije fizičke pojavnosti tjelesnih iskustava, a način na koji se slika o tijelu razvija nije samo prirodni već i kulturološki posredovan proces. Kako slika o tijelu ovisi o očekivanjima i standardima, te o idealnoj slici koju je osoba izgradila o svom tijelu, vrlo je važno istraživati i pritom razviti sustav procjene slike o sebi na uzorku profesionalnih plesača kod kojih će se standardi zasigurno razlikovati od prosječne sportske populacije. Prema Ambrosi-Radnić (2003) slika o tijelu sadržava: percepcije i stavove o vlastitom tijelu, tjelesni položaj u prostoru, tjelesne granice, tjelesne kompetencije te aspekte tijela povezane s dobi. Poznato je da su plesači veoma kritični prema svom fizičkom izgledu, što je povezano sa poremećajima u prehrani (Anshel, 2004; Ravaldi i sur., 2006) te možemo pretpostaviti da će slika o sebi posredno utjecati i na trenažna opterećenja, ali nije poznato kako.

Istraživanje provedeno zasebno po spolu, omogućuje uvid u specifičnosti i razlikovanje muškog i ženskog plesnog identiteta, što osim plesački-praktičnog ima i izuzetno važan socijalni učinak. Sportski ples je disciplina koja se izvodi u paru te se tako problemu samopoimanja plesnih parova treba i pristupati i to zasebno po spolu, poštujući trenažne, tehničke, antropološke, psihološke i sociološke spolne osobitosti kod natjecatelja u sportskom plesu.

Konstrukcija mjernog instrumenta (upitnika) kojom se može procijeniti slika o sebi kod plesača (Miletić, 2012), rješava važan problem uvida u specifičnosti i razlikovanje muškog i ženskog plesnog identiteta ali ostaje neistraženo područje povezanosti dimenzija identificiranih upitnikom s trenažnim, kineziološkim specifičnostima.

Cilj istraživanja je utvrditi strukturu i povezanost dimenzija tjelesne slike o sebi kod sportskih plesača s trenažnim ekstenzitetom, posebno po spolu

METODE RADA

Uzorci entiteta u ovom istraživanju su aktivni plesni parovi, natjecatelji u sportskom plesu koji su sudjelovali na međunarodnim natjecanjima u latinoameričkim (samba, rumba, cha-cha-cha, paso doble i jive) i standardnim (engleski valcer, tango, bečki valcer, slowfox i quickstep) plesovima.

Ukupan prikupljeni uzorak ima 373 plesača sportskog plesa i to: 173 plesačice i 200 plesača. Na ukupnom uzorku plesačica prosječne vrijednosti

tjelesne visine iznose $165,7 \pm 6,49$; prosječne vrijednosti tjelesne težine iznose $53,7 \pm 6,84$ i prosječne vrijednosti BMI iznose $19,5 \pm 1,9$. Na ukupnom uzorku plesača prosječne vrijednosti tjelesne visine iznose $177,8 \pm 7,73$; prosječne vrijednosti tjelesne težine iznose $69,1 \pm 10,1$ i prosječne vrijednosti BMI iznose $21,8 \pm 2,5$. Prosječna dob ukupnog prikupljenog uzorka kod plesačica je 24 godine (raspon od 15 do 38); a kod plesača 25 godina (raspon od 15 do 40). Plesači i plesačice koji predstavljaju uzorak ispitanika u ovom istraživanju dolaze iz 53 različitih zemalja svijeta.

Primijenjen je upitnik za procjenu slike o tijelu kod plesača prema koji je izrađen pilot studiji (Milavić, Miletić, Miletić, 2012) na uzorku studenata kineziologije, te zatim rekonstruiran na plesačima (Miletić 2012). Izolirano je osam faktora koji su objasnili ukupno 87,67 % zajedničke varijance i to: prvi (atraktivnost), drugi (radost), treći (tjelesna efikasnost), četvrti (fleksibilnost), peti (energičnost), šesti (snaga), sedmi (loše zdravlje/ nervoza) i osmi (muževnost/ženstvenost). Dobivene su razmjerno visoke interne konzistencije latentnih dimenzija te zadovoljavajuće metrijske karakteristike osjetljivosti i homogenosti.

Prema kriteriju trenažnog ekstenziteta ukupan uzorak je podijeljen na pet subuzoraka prema različitom trenažnom ekstenzitetu koji je određen prema prosjeku sati odrađenih treninga unutar jednog tjedna kako slijedi: (1) jedan do pet sati treniranja tjedno; (2) šest do deset sati treniranja tjedno; (3) jedanaest do petnaest sati treniranja tjedno; (4) šesnaest do dvadeset sati treniranja tjedno i (5) dvadeset jedan i više sati treniranja tjedno

Podatci za istraživanje prikupljeni su kombinacijom ispunjavanja upitnika tipa „papir -olovka“ i „on – line“ metode prikupljanja podataka. Pripremljen je upitnik koji je u konačnici preveden na osam svjetskih jezika, a podatci su prikupljeni: upisivanjem teksta, upisivanjem brojčanih vrijednosti u predviđeno polje; odabirom jednog od ponuđenih odgovora. „On – line“ upitnik postavljen je na specijaliziranom serveru namijenjenom elektronskom prikupljanju i analizi podataka na globalnoj razini (https://www.surveymonkey.com/MyAccount_Login.aspx). Server i aplikacija omogućili su razinu zaštite pristupa lozinkom i automatsku identifikaciju ispitanika pri popunjavanju upitnika s određenog računala definiranog IP adresom te osobnim podacima.

REZULTATI I RASPRAVA

Kako bi se procijenile razlike između skupina plesačica i plesača koji treniraju različitim ekstenzitetom, a u odnosu na dimenzije testa za procjenu slike o sebi u latentnom prostoru, izračunata je diskriminativna kanonička analiza.

Prema Miletić A (2012) utvrđene su dobre metrijske karakteristike za procjenu tjelesne slike o sebi na uzorku plesačica i plesača u sportskom plesu. Faktorizacijom matrice sa 36 varijabli te oblimin rotacijom, a prema Guttman – Kaiserovom kriteriju izolirano je osam faktora koji su objasnili ukupno 87,67 % zajedničke varijance i to: prvi (atraktivnost), drugi (radost), treći (tjelesna efikasnost), četvrti (fleksibilnost), peti (energičnost), šesti (snaga), sedmi (loše zdravlje/ nervoza) i osmi (muževnost/ženstvenost). Dobivene latentne dimenzije primijenjene su i u ovom istraživanju.

U istom istraživanju utvrđeno je da postoje razlike između muškaraca i žena, natjecatelja u sportskom plesu, u poimanju slike o sebi i to u poimanju slike o sebi u dimenzijama atraktivnost, fleksibilnost i muževnost/ženstvenost. Dobivene razlike u ljestvicama atraktivnost i fleksibilnost idu u korist žena, dok je razlika u ljestvici muževnost/ženstvenost u korist muškaraca.

Tablica 1. Diskriminativna analiza dimenzija slike o tijelu plesačica na trenažni ekstenzitet

DF	λ	Rc	Wilks' lambda	χ^2	SS	P =
1	0,14	0,36	0,78	40,20	32,00	0,15
2	0,06	0,25	0,90	17,81	21,00	0,66
3	0,03	0,17	0,96	7,39	12,00	0,83
4	0,01	0,12	0,99	2,25	5,00	0,81

Tablica 2. Diskriminativna analiza dimenzija slike o tijelu plesača na trenažni ekstenzitet

DF	λ	Rc	Wilks' lambda	χ^2	SS	P =
1	0,14	0,36	0,78	47,78	32,00	0,04
2	0,07	0,25	0,89	21,72	21,00	0,42
3	0,04	0,19	0,95	9,27	12,00	0,68
4	0,01	0,11	0,99	2,50	5,00	0,78

Tablica 3. Matrice strukture

	1 plesalice	1 plesaci
EFIKASNOST	-0,11	-0,06
LOŠE ZDR./NERVOZN.	-0,30	0,27
MUŽE./ŽENSTVENOST	-0,44	0,34
FLEKSIBILNOST	-0,06	-0,55
RADOST	0,39	0,05
ENERGIČNOST	-0,09	-0,61
SNAGA	0,35	-0,04
ATRAKTIVNOST	-0,23	0,29

Tablica 4. Centroidi skupina

	1 plesalice	1 plesaci
1 - (1-5 sati)	-0,15	-0,69
2 - (6-10 sati)	0,33	0,03
3 - (11-15 sati)	0,13	-0,12
4 - (16-20 sati)	-0,88	0,14
5 - (21 i više sati)	-0,31	0,75

Na uzorku plesačica (tablica 1) diskriminativna funkcija s vrijednošću Wilksove lambde .78 nije značajna (na razini $p < .05$), te nije interpretirana ni matrica strukture kao ni centroidi grupa (tablice 3 i 4 za podatke koji se odnose na plesalice).

Na uzorku plesača (tablica 2) diskriminativna funkcija s vrijednošću Wilksove lambde .78 značajna je (na razini $p < .04$), sa kanoničkom korelacijom .36.

Iz tablice 3 vidimo da faktorsku strukturu ove diskriminacijske funkcije definiraju dominantno energija (-.61) i fleksibilnost (-.55). Centroidi skupina na diskriminacijskoj funkciji (tablica 4) pokazuju da takva latentna dimenzija opisuje više plesača koji treniraju do 15 sati tjedno. Drugu skupinu predstavljaju plesaci koji treniraju više od 15 sati tjedno, s najvišom vrijednosti centroida u

grupi plesača koji trenira više od 21 sat tjedno. Možemo zaključiti da je upravo ova grupa najbolje razdvojena diskriminativnom funkcijom.

Prema dobivenim rezultatima, plesači koji imaju dobru percepciju o fleksibilnosti i energiji imaju niži trenažni intenzitet. Ovakvi rezultati nisu očekivani jer bi oni koji najviše treniraju trebali imati i veću percepciju svog dobrog stanja fizičkih sposobnosti. Potrebna su dalja istraživanja koja bi sadržavala egzaktne vanjske pokazatelje trenažnog ekstenziteta povezano sa trenažnom i životnom dobi plesača kako bi se mogli interpretirati dobiveni rezultati.

ZAKLJUČAK

Prema kriteriju ekstenziteta treninga na uzorku plesačica, nema značajnih razlika između grupa sa različitim tjednim trenažnim opterećenjem koje bi definirale dimenzije slike o tijelu.

Na uzorku plesača faktorsku strukturu diskriminacijske funkcije po intenzitetu treninga definiraju dominantno energija i fleksibilnost. Plesači koji imaju dobru percepciju o fleksibilnosti i energiji imaju niži trenažni intenzitet. Ovakvi rezultati nisu očekivani jer bi oni koji najviše treniraju trebali imati i veću percepciju svog dobrog stanja fizičkih sposobnosti. Potrebna su dalja istraživanja koja bi sadržavala egzaktne vanjske pokazatelje trenažnog intenziteta povezano sa trenažnom i životnom dobi plesača kako bi se mogli interpretirati dobiveni rezultati.

LITETRATURA

Anshel, M. H. (2004). Sources of disordered eating patterns between ballet dancers and non-dancers. *Journal of Sport Behavior*, 27, 115-133.

Ambrosi-Radnić, N. (2003). Novija istraživanja u području predodžbe o vlastitom tijelu. *Metodički ogledi*, 10(1), 69-81.

Cashmore, E. (2008). *Sport & Exercise Psychology – The Key Concepts* (2nd edition). Routledge-Taylor & Francis. New York. Milavić, B., Miletić, A., & Miletić, Đ. (2012). Impact of Body Mass Index on Body Image Dimensions: Results from a Body-Image Questionnaire Designed for Dancers. *Medical Problems of Performing Artists*, 27(3), 95-101.

Miletić, A. (2012). Faktori utjecaja na natjecateljsku uspješnost u sportskom plesu. (Disertacija). Kineziološki fakultet Sveučilišta u Splitu

Ravaldi, C., Vannacci, A., Bolognesi, E., Safania, M., Faravelli, C., & Ricca, V. (2006). Gender role, eating disorders symptoms, and body image concern in ballet dancers. *Journal of Psychosomatic Research*, 61, 529-535.

Training Effects on Peak Torque and Total Work of Knee and Elbow Extensor and Flexor Muscle in Female Karate Athletes

Safet Kapo, Nedim Čović, Izet Rađo, Husnija Kajmović,
Nusret Smajlović, Siniša Kovač

*Faculty of Sport and Physical Education,
University of Sarajevo, Bosnia and Herzegovina*

ABSTRACT

The aim of this study was to determine the effects of karate training in performing defence and offense tactic and technique elements reflecting as peak torque (Pt) and total work (TW) alterations of knee and elbow extensor and flexor muscles. The conducted programme lasted for 12 weeks, with 3 training sessions per week. The subjects were female karate athletes (n=22) on average 13.6 ± 2.1 years old, with at least 3 years of experience in karate sport. The results of the conducted programme indicated some minor changes in the above mentioned variables (ES range: 0.14-0.38). Therefore, it was necessary to conduct an analysis of the effects of karate training in regards to changes in isokinetic elbow and knee potential, bilateral differences and antagonistic relations between the muscles, since these are regarded as important elements in achieving karate excellence.

INTRODUCTION

Karate is a complex competitive sport, representing a combination of martial arts and a person's psychological perseverance. For achieving success in karate the most important motor abilities are speed, power and aerobic power (Adamczyk & Antoniak, 2010). Other important abilities are balance, postural stability and flexibility (Roschel et al., 2009). The effects of karate training in young karate athletes reflected as improvement in their balance skills (Vando et al., 2013). The time of acceleration and the time of the peak

torque in elite karate athletes knee and elbow performance did not differ bilaterally (Scattone-Silva, Lessi, Lobato, & Serrão, 2012). These results suggest that there is no difference between the level of strength and power regarding the dominant and non dominant leg in karate athletes. Based from present research that included male subjects mostly, it would be very interesting to determine the effects of karate training on young female karate athletes.

Considering that karate is a popular sport, and that there is a great number of those who practice it recreationally to improve their health (Douris et al., 2004), one might pose a question as to what are its effects on the performance of those who practice it. The basic principle of sport is health, regardless if we are referring to sport as recreational or professional (Faigenbaum & Myer, 2010), therefore it is important to know what changes are induced by exercising, especially in regards to sensitive children's growth. It is of great importance to analyse the effects of karate training in regards to the changes in young female karate athletes and to determine whether the effects are positive or negative, including the overall assessment of karate sport impact on muscle performance status. What is characteristic about this age is the intensive growth which can affect the level of strength (Ingle, Sleaf, & Tolfrey, 2006). Of course, there are differences between the training process of men and women, and in the speed of adapting to an assigned training.

Peak torque and the total work can project the speed of movement performance and the ability of sustaining it. The most important element of physical condition which is necessary for the success in karate is explosiveness and mobility of lower extremities (Blažević, Katić, & Popović, 2006). Technical aspect of karate training is based on different patterns of movement such as explosive leg movement, endurance and energetic movement. These patterns of movement could influence the change on the quality level of strength, where knees in particular endure a great load. In regards to theoretical assumption, karate training affects the level of muscle strength through various mechanisms of body adaptation. One might pose a question, whether and to what amount karate training affects the strength and leg muscle power development. The authors who acknowledge that karate training and its effects have been poorly analysed, also state that the same goes for the strength development through karate training. Considering that karate is a specific martial sport, in which case the contact with the opponent is not essential, and the hitting impulse is not significantly related to strength, a question is posed as to whether karate training can influence the improvement of peak torque in leg muscles regarding that this does not present the primary aim of karate training.

The aim of this research was to determine bilateral differences and effects of programmed karate training in regards to peak torque parameter changes and total elbow and knee muscles work. We have assumed that karate training will affect the value increase of peak torque momentum and total knee and elbow work. Likewise, an assumption of this research is that there is smaller number of bilateral differences within the given parameters.

METHODS

Experimental approach

Female karate athletes from local club were selected to participate at national and international competitions with at least three years of sport experience. Experimental programme was designed consisting of three mesocycles and lasting twelve weeks in total. Training units were designed for technical kata and fighting purposes, without additional elements in strength and power development. The programme was conducted three times a week. Training units lasted on average 87 ± 1.7 min. Subjects on average participated 2.8 ± 0.1 training units. Training episodes were designed as a sequenced programme with 15 minutes of dynamic warm up followed by specific technical elements (katas) and kumite (fight) training. Complete training process was overseen by an expert coach. Programme was conducted in the period May – September 2014. The research lasted for 4 months.

Sample

The sample consisted of female karate athletes ($n=22$) (mean \pm SD: 13.6 ± 2.1 year; 160.4 ± 10.1 cm; 55.9 ± 14.4 kg). All the female karate athletes were without injuries and healthy, therefore they were able to conduct the entire programme. Neither of the subjects was hurt during the programme, nor have they abandoned the training process. The entire procedure was conducted in accordance with the Helsinki Committee Declaration, and a written consent was signed by the athletes parents. Subjects were allowed to abandon study at any time.

Measurement procedures

Measuring isokinetic parameters of peak torque (Pt) and total work (TW) was conducted on isokinetic dynamometer Byodex System 3 (Byodex, Sherly New York), between 9 and 10 in the morning. Knee isokinetic parameters were

measured immediately after elbow isokinetic parameters were taken. For each subject, the instrument was set in accordance with the standard protocol, and the values used were expressed by absolute units. Warm up protocol for each subject was conducted by the same procedure consisting of 5 minutes bicycle ride at 50W and a set of 7 dynamic stretching exercises. The main testing protocol in isokinetic parameters consisted of three (3) test trials, and five (5) attempts of purposeful maximum muscle contraction. The isokinetic knee parameter analysis was conducted at two angular velocities values of 60°/sec and 180°/sec. Isokinetic elbow potential was analyzed at two angular speed values 60 and 120°/sec. Protocol was conducted by 4 trained isokinetic dynamometer analysts. The highest peak torque measurement (Pt) was illustrated as the highest torque, expressed in Newton meters (Nm), and determined during knee extension and flexion for both knees and elbows at the speed value indicated above. Total work (TW) was demonstrated as flexor and extensor performance conducted during the entire measurement protocol and expressed in Joules (J), determined in regards to knee and elbow performance.

Statistical analysis

Standard distribution of data was evaluated by Shapiro – Wilk W test. Significance of result differences was evaluated by student t test for the paired samples (repeated measurements). Effect size (ES - Cohen'd) was calculated for the variables where specific result differences were determined. ES values ranging from 0 - 0.19 as trivial effect, 0.2-0.49 small effect, 0.5-0.79 middle effect, and higher from 0.8 great effect (Cohen, J., 1988). Data were processed by software SPSS 20.0 system (IBM Corp., Chicago). Data was expressed as mean value \pm standard deviation (SD). The level of statistical significance was determined at $p < 0.05$.

RESULTS

According to Shapiro Wilk W test results all the variables had normal data distribution. No statistical significance was determined in the differences of heights and age at the beginning and at the end of the research. Statistically significant bilateral differences. Subjects have statistically reduced their body mass for 0.7 kg ($p = 0.02$; *trivial effect ES = 0.04*). Significant differences in knee torque were determined in left leg flexion at the angular speed of 60°/

sec ($p = 0.03$; small effect $ES = 0.28$). Differences in the results of elbow torque were determined in the right arm extension at the angular speed of $60^\circ/\text{sec}$ ($p = 0.034$; small effect $ES = 0.33$), left arm extension ($p = 0.026$; small effect $ES = 0.37$), right arm extension at $120^\circ/\text{sec}$ ($p = 0.045$; small effect $ES = 0.3$). Higher total work (TW) of the knee at $60^\circ/\text{sec}$ in the final measurement was determined in the right leg extension ($p = 0.03$; trivial effect $ES = 0.14$) and left leg extension ($p = 0.032$; small effect $ES = 0.22$). Differences in the total work (TW) of the elbow at the speed of $60^\circ/\text{sec}$ have been determined in the right arm extension ($p = 0.002$; trivial effect $ES = 0.15$) and left arm flexion ($p = 0.001$; small effect $ES = 0.32$).

Table 1 Knees peak torque and total work in flexion and extension at $60^\circ/\text{sec}$ and $180^\circ/\text{sec}$.

	Base line (mean \pm SD)	Study end (mean \pm SD)	Base line (mean \pm SD)	Study end (mean \pm SD)
(n = 22)				
$60^\circ/\text{sec}$				
	PT (Nm)		TW (J)	
Right ex.	124.44 \pm 36.43	129.29 \pm 36.76	538.32 \pm 164.83	560.8 \pm 161.4* ES (0.14)
Left ex.	121.59 \pm 33.13	126.19 \pm 33.25	514.09 \pm 142.52	546.35 \pm 148.1* ES (0.22)
Right fl.	59.36 \pm 19.71¥	62.95 \pm 19.5¥	269.84 \pm 88.65	280.12 \pm 91.5¥
Left fl.	54.65 \pm 17.96	59.5 \pm 16.78* ES (0.28)	257.85 \pm 87.29	262.43 \pm 86.35
$180^\circ/\text{sec}$				
	PT (Nm)		TW (J)	
Right ex.	87.49 \pm 24.22	89.11 \pm 24.18	432.94 \pm 116.14	442.44 \pm 109.13
Left ex.	86.06 \pm 22.61	89.97 \pm 21.99	423.99 \pm 110.32	435 \pm 105.51
Right fl.	48.33 \pm 13.11¥	50.14 \pm 12.82	228.46 \pm 62.76	229.41 \pm 64.65
Left fl.	45.27 \pm 10.98	47.73 \pm 11.6	232.03 \pm 67.55	237.09 \pm 72.6

* $p < 0.05$, ** $p < 0.01$, PT – peak torque, TW – total work, ex. – extension, fl. - flexion
¥ - significantly higher compared to the left side

Table 2 Elbows peak torque and total work in flexion and extension at 60°/sec and 120°/sec.

	Base line (mean ± SD)	Study end (mean ± SD)	Base line (mean ± SD)	Study end (mean ± SD)
	(n = 22)		(n = 22)	
	60°/sec		60°/sec	
	PT (Nm)		TW (J)	
Right ex.	32.97 ± 7.49¥	35.51 ± 7.68* ¥ ES (0.33)	213.62 ± 47.85¥	221.48 ± 55.29**¥ ES (0.15)
Left ex.	29.89 ± 5.64	32.44 ± 7.83* ES (0.37)	194.24 ± 43.92	194.54 ± 47.82
Right fl.	21.51 ± 5.98	23.28 ± 5.57	122.29 ± 41.64	136.05 ± 34.58
Left fl.	22.69 ± 6.09	24.82 ± 6.5	137.6 ± 39.72§	149.75 ± 37.11**§ ES (0.32)
	120°/sec		120°/sec	
	PT (Nm)		TW (J)	
Right ex.	26.5 ± 5.95¥	28.26 ± 5.66* ¥ ES (0.30)	189.38 ± 50.2¥	188.05 ± 41.7¥
Left ex.	24.23 ± 5.45	24.92 ± 5.49	168.38 ± 51.37	158.32 ± 43.74
Right fl.	17.78 ± 5.84	18.28 ± 5.2	106.65 ± 43.4	101.55 ± 35.38
Left fl.	18.66 ± 4.25	18.55 ± 5	111.57 ± 37.36	119.48 ± 33.01§

*p<0.05, **p<0.01, PT – peak torque, TW – total work, ex. – extension, fl. - flexion
¥ - significantly higher compared to the left side, § - significantly higher compared to the right side

DISCUSSION

Influenced by the karate programme, female karate athletes have morphologically reconstructed the body mass and reduced it for 0.7kg. All the girls have a relatively similar body mass, height and morphological size which can affect the results of peak torque and total work. The results of this research indicate that karate training has in small amount affected the change in values of peak torque and total work in female karate athletes extensor and flexor knee and elbow muscle. Based on the values of the size of the effect (*ES has indicated variations of 0.14-0.37*) one can state that the effect of karate training

on the torque peak and total work alteration was insignificant and minor. During the extension and flexion of the right leg, in female karate athletes a much greater value of torque peak and total work was expressed in relation to the left leg. Greater values of torque peak and total work were registered in the right arm extension, while greater values of flexion were indicated in the left arm. What can be regarded as specific in the research analysis is that the applied programme has generated more value alterations in relation to peak torque and total work of the elbow muscles than the knee muscles. These results can be connected to the importance of performing fast hand techniques in karate (Roschel et al., 2009). Regarding the characteristics of karate programme and movement patterns, one can conclude that the intensity or total volume of three times per week were not suitable to cause significant changes since karatekas were experienced and well trained.

Positive affect of karate training in regards to the lower extremity strength increase in karate athletes aged from 8 to 13 have been established by Violan and co-authors (Violan, Small, Zetariuk, & Micheli, 1997). Results of the research have confirmed that karate training increases isokinetic knee parameters, measured at 60°/sec. Programmed training performed within this research consisted of high intensity training exercises, therefore it is regarded as one of the major reasons which have led to the increase in the strength of lower extremities in such a short period of time. Isokinetic parameters in elite karate athletes are greater if compared to the amateurs (Sbriccoli et al., 2010). Long term training process in karate has in regards to elite karate athletes generated a strength increase in the lower extremities. There is a great connection between strength and agility when it comes to performing karate elements (Katić, Maleš, & Miletić, 2002), therefore the more successful ones are those that have a better understanding of the basic motor abilities. According to Padulo (2014) karate training contributes to the development of the explosive strength, which was measured by performing long jump and medicine ball throw tests, however no results were recorded in relation to the isokinetic peak torque parameters. Training programme conducted by the authors consists of a great number of exercises designed for developing the strength and power and for the most part differ from the one performed in our study which is over 70% of time dominated by technical fight elements. The subjects differ in age, and were not trained to work on the isokinetic dynamometer, contrary to the respondents from mentioned study who performed jumping and throwing which allows increase in power parameters and might cause sudden peak power jump.

Research indicated that there are slightly significant bilateral differences between knee and elbow extensor and flexor muscles. Regarding the knee muscles the greatest bilateral differences were confirmed in the left and right flexion. The programme conducted in our research did not decrease the existing differences, but has contributed to an increase of differences regarding to the total work variable. Data obtained in relation to the bilateral differences indicate an increase which is not in accordance with the results gained by the individual research conducted so far. Concerning the results obtained by Scattone (Scattone-Silva et al., 2012) the results of this research indicate the existence of bilateral differences. The results can be explained as such by observing the characteristics of tested subjects, elite karate athletes as opposed to female karate athletes. Diversity and bilateral differences could be expected considering the age variability of the tested subjects. Likewise, a well regulated training can generate asymmetries between the agonist and antagonist which can contribute to contestant knee and elbow injuries (Scattone-Silva et al., 2012). Special attention should be devoted to precisely this segment. Contrary to the mentioned results, bilateral differences were determined in younger female karate athletes (Do Kim & Pieter 2014). These results are similar to the results which were obtained in this research. Sample is on average 6 years older than our test subjects. From the above stated, one can assert that female karate athletes, unlike elite karate athletes demonstrate bilateral differences even in older age.

Restrictiveness of the study can be reflected in a relatively non homogeneous sample of girls in relation to the competition level. Further research is required for the study of the extensor and flexor elbow muscle strength, regarding the fact that explosive strength and speed of upper extremities is crucial for the elite karate athletes performance (Stockbrugger & Haennel, 2001). Likewise, it is necessary to evaluate the karate training effect on the changes of isokinetic knee parameters in girls of younger age.

CONCLUSION

According to the results of previous research, one can state that karate training affects the torque peak in knee and elbow muscles in elite karate athletes. The research has not confirmed the existence of significant changes in the level of strength in female karate athlete. The conducted programme consisted of those fighting elements used in offense and defence and it was not efficient enough to have any impact in strength increase as a significant

motor ability which can contribute to greater efficiency. Karate training has slightly improved the elbow and knee strength. Further research is necessary to determine the karate training effect in regards to strength increase in female karate athletes. Karate training slightly increases the upper and lower extremity strength but it does not improve the bilateral differences in strength.

REFERENCES

Adamczyk, J., & Antoniak, B. (2010). Specific fitness level in Fudokan Karate competitors at different levels of advancement. *Journal of Combat Sports and Martial Arts*, 2, 101-107.

Blažević, S., Katić, R., & Popović, D. (2006). The effect of motor abilities on karate performance. *Collegium antropologicum*, 30(2), 327-333.

Douris, P., Chinan, A., Gomez, M., Aw, A., Steffens, D., & Weiss, S. (2004). Fitness levels of middle aged martial art practitioners. *British journal of sports medicine*, 38(2), 143-147.

Faigenbaum, A. D., & Myer, G. D. (2010). Resistance training among young athletes: safety, efficacy and injury prevention effects. *British journal of sports medicine*, 44(1), 56-63.

Ingle, L., Sleaf, M., & Tolfrey, K. (2006). The effect of a complex training and detraining programme on selected strength and power variables in early pubertal boys. *Journal of sports sciences*, 24(9), 987-997.

Katić, R., Maleš, B., & Miletić, Đ. (2002). Effect of 6-month athletic training on motor abilities in seven-year-old schoolgirls. *Collegium antropologicum*, 26(2), 533-538.

Roschel, H., Batista, M., Monteiro, R., Bertuzzi, R. C., Barroso, R., Loturco, I., . . . Franchini, E. (2009). Association between neuromuscular tests and kumite performance on the Brazilian Karate National Team. *Journal of sports science & medicine*, 8(CSSI3), 20.

Sbriccoli, P., Camomilla, V., Di Mario, A., Quinzi, F., Figura, F., & Felici, F. (2010). Neuromuscular control adaptations in elite athletes: the case of top level karateka. *European journal of applied physiology*, 108(6), 1269-1280.

Scattonne-Silva, R., Lessi, G., Lobato, D., & Serrão, F. (2012). Acceleration time, peak torque and time to peak torque in elite karate athletes. *Science & Sports*, 27(4), e31-e37.

Stockbrugger, B. A., & Haennel, R. G. (2001). Validity and reliability of

a medicine ball explosive power test. *The Journal of Strength & Conditioning Research*, 15(4), 431-438.

Vando, S., Filingeri, D., Maurino, L., Chaabène, H., Bianco, A., Salernitano, G., . . . Padulo, J. (2013). Postural adaptations in preadolescent karate athletes due to a one week karate training camp. *Journal of human kinetics*, 38, 45-52.

Violan, M. A., Small, E. W., Zetariuk, M., & Micheli, L. J. (1997). The effect of karate training on flexibility, muscle strength, and balance in 8-to 13-year-old boys. *Pediatric Exercise Science*, 9, 55-64.

Application of the multidimensional inventory of sport excellence on the samples of young top female handball and volleyball players

Joško Sindik¹, Vatroslav Horvat², Marijana Hraski², Damir Sertić³

¹*Institute for Anthropological Reserach, Zagreb, Croatia*

²*Faculty of Education, University of Zagreb, Croatia*

³*Private university Supera, Zagreb, Croatia*

ABSTRACT

Numerous psychological instruments are developed with a purpose assess psychological characteristics of athletes. In this study, recently preliminary validated battery of questionnaires, named Multidimensional Inventory of Sport Excellence (MUSI) is applied. From entire MUSI, several subscales are applied, measuring following psychological characteristics: mental energy, cognitive anxiety, somatic anxiety, attention focusing, awareness about attention, wide internal/external attention, awareness about attention during performance, internal speech and narrow external focus. The main goals of the study are: to determine the differences between top female handball and volleyball players in abovementioned psychological characteristics (1); to determine the correlations between these psychological characteristics, separately for handball and volleyball players (2). Sample of 91 female athletes, 35 handball and 56 volleyball players (mean age for handball 16.49 ± 3.71 and 14.04 ± 2.74 for volleyball) were included in the study. They are recruited from sport clubs in Rijeka: "Rijeka" (volleyball) and "Zamet" (handball). Data were collected from March to June 2014 in Rijeka, during the trainings in sports clubs. The results revealed that only one statistically significant difference is found between female handball and volleyball players in the aspects of MUSI (in somatic anxiety, higher means female handball players had higher means than volleyball players did). Approximately half of the correlations between different psychological characteristics were low to moderate statistically

significant (and mostly positively) correlated, with just a bit more significant correlations found in volleyball players. The results provide the information mostly about the similarities in examined psychological characteristics in these two sports, as well as the similar profiles in the relationships between these characteristics.

Keywords: coaching, diagnosis, female athletes, sports excellence

INTRODUCTION

The purpose of recently preliminary validated battery of questionnaires (named Multidimensional Inventory of Sport Excellence, hereinafter MUSI) is to help sport experts to understand how an individual perform under a variety of sport situations. This information is very useful for the practical work with the athletes, for the coaches or sport psychologists.

Mental energy describes specific biological processes involved in the capacity of brain neurons to do physical work. Practically, mental energy refers to the mood or motivational and cognitive processes. Self-reported feelings are recognized as the best method for assessing mood (O'Connor, 2006). Attention allows selecting information, sensations and perceptions that are relevant now, because the performance in an athletic event requires an athlete to focus upon the task at hand in order to achieve success. Vigilance and choice reaction time are psychometrically convenient for assessing mental energy (Lieberman, 2006). Tests of reaction time and vigilance are associated with mood states corresponding to mental energy, such as sleepiness, fatigue, and alertness and are of approximately equivalent sensitivity. **Competitive anxiety** is the characteristic that describe the experience of the competition, which could be perceived as more or less stressful: in the form of „negative» thoughts (cognitions), as well as negative emotions, followed by physiological indicators (Cox, 2005; Spielberger, 1983). Successful confrontation with this competitive stress causes lower incidence of competitive anxiety. Theory of Attentional and Interpersonal Style (TAIS) had the goal to be useful in predicting performance and in providing feedback about **concentration** skills to individuals involved in a wide variety of performance areas (Nideffer, 1976). This theory brings together performance relevant constructs in such a way as to accurately predict how people will perform in wide variety of situations. TAIS considers concentration along two dimensions: 1) breadth: at any given moment, attention could be

either Broad (focused on multiple things simultaneously) or Narrow (focused on one thing); and 2) direction: focus could be either External (focused outside your head) or Internal (focused inside your head) (Nideffer, 1976). **Attention** is a concept that describes actively processing specific information presented in our environment. It allows to an individual to “filter out” information, sensations and perceptions that are not relevant for certain task and instead focus on the information that is important (Abernethy et al., 1998). While low arousal may introduce unwanted competition between irrelevant and relevant cues, high levels of arousal could lead to the phenomenon of distractibility. The athlete with higher distractibility tends to experience sudden and significant decrements in performance (Abernethy et al., 1998). However, it is important to classify stimuli that require conscious or controlled attention as either task relevant, or task irrelevant. Successful eliminating distractors is the ability to recover quickly which is probably the single most important factor separating successful athletes from unsuccessful ones (Orlick&Partington, 1990). Most performance in sport is demanding, requiring athletes to combine very complex motor sequences, using the perceptual information (e.g., information about the location of the goal, other players, etc.) with internal information (e.g., feedback from the body about its position in space), to create patterns that the brain can recognize at a preconscious level (Norman, 1968). In this study, young female athletes in two team sports are particularly chosen to compare certain psychological characteristics, considering that the differences could reflect requests of certain sport, as well as coaching style. The first **goal** of this research was to determine the differences between top female handball and volleyball players in following psychological characteristics: mental energy, cognitive anxiety, somatic anxiety, attention focusing, awareness about attention, wide internal/external attention, awareness about attention during performance, internal speech and narrow external focus. Moreover, the **second goal** was to determine the correlations between these psychological characteristics, separately for handball and volleyball players. These results could provide the information about the level of the development of certain psychological characteristics in these sports, as well to give useful data for coaches’ work.

METHODS

Participants and procedure. In total 91 female athletes, 35 handball and 56 volleyball players (mean age for handball 16.49 ± 3.71 and for volleyball 14.04 ± 2.74) were involved in the study. They are recruited from sport clubs

in Rijeka: "Rijeka" (volleyball) and "Zamet" (handball). Their playing experience was: 8.06 ± 3.83 (handball) and 5.13 ± 2.64 (volleyball). According to the level of sport excellence, all participants were semi-professionals (they work or study regularly out of sport, but they are engaged in regular training and national competitions). Data are collected between March 2014 and July 2014 in the city of Rijeka, Croatia. Participants always filled out the questionnaire anonymously in the presence of a research assistant, or during or during the training, in their respective sports clubs.

Measures. Items of all questionnaires in battery followed the assumptions from theoretical frameworks and belonging measuring instruments: Profile of Mood States (POMS) (McNair et al., 1971, 2003), State-Trait Anxiety Inventory (STAI) (Spielberger, 1983) and The Attentional and Interpersonal Style (TAIS) (Nideffer, 1976), but with significant modifications. For the measuring mental energy, Mental Energy Scale consists of 14 items based on the self-evaluation of the level of mental energy (Sindik et al, 2015). For measuring attention (concentration) we have developed Maintaining Attention Scale, with 12 items based on the self-evaluation of the level of 'adequate concentration'. Extensive Internal Attention Scale consists of 9 items, while Extensive External Attention Scale, as well as Narrow Internal Attention Scale and Narrow External Attention Scale, and consists of 7 items, each. Finally, Cognitive and Somatic Anxiety Scales (both with 14 items) are developed to measure these two aspects of anxiety. All the questionnaires are using estimation Likert 5-point scale ranging from strongly disagree (1) to strongly agree (5) The results are defined as a simple linear combination of the estimations of the items, which define certain dimension of the attention. Higher estimation means higher attention skills and higher level of anxiety, except in case of Extensive internal attention (lower score means higher developed skills). The reliabilities type internal consistency in this study varied in range from 0.72 to 0.90, for all questionnaires in MUSI, very similarly wit.

Statistical Analyses. In the statistical analyses of the data, the software package SPSS 20.0 is used for both samples of participants. The reliability type internal consistency for all components (factors) revealed was determined using Cronbach's alpha coefficient. The differences are tested using independent sample t-test, while the correlation analyses were performed using Spearman rank-correlation coefficients. The significance of differences commented on the probability level $p < 0.05$.

RESULTS

In Table 1 could be inspected that only one statistically significant difference is found between female handball and volleyball players in the aspects of MUSI. In the aspect of somatic anxiety, higher means are found in female handball players, as compared with volleyball players.

Table 1 – Differences between female handball and volleyball players in the aspects of MUSI

Variables	Type of sport	Mean	Std. Deviation	t-test (df=90)
attention focusing	handball	3.612	0.753	0.136
	volleyball	3.589	0.782	
awareness about attention	handball	3.551	0.607	0.139
	volleyball	3.532	0.693	
wide internal attention	handball	2.627	0.708	0.985
	volleyball	2.471	0.754	
wide external attention	handball	3.645	0.666	-0.223
	volleyball	3.678	0.696	
awareness about attention during performance	handball	3.895	0.598	1.737
	volleyball	3.619	0.813	
internal speech	handball	3.329	0.774	1.317
	volleyball	3.094	0.859	
mental energy	handball	3.878	0.738	0.405
	volleyball	3.812	0.695	
cognitive anxiety	handball	3.265	0.672	1.842
	volleyball	2.969	0.787	
somatic anxiety	handball	2.095	0.737	2.471*
	volleyball	1.742	0.522	

Legend: * t-test significant at $p < 0.05$

In the following two analyses, we have used obtained latent dimensions of MUSI, to calculate the correlations among these latent dimensions of psychological characteristics, separately for female handball players (Table 2) and volleyball players (Table 3). In handball players, out of 45 correlations between variables of MUSI, included in this study, 20 of these correlations were statistically significant (two negative-directed, while the others were positive), and mainly low or moderate high (Table 2).

Table 2 – Correlations between the aspects of MUSI in female handball players

Handball players	mental energy	cognitive anxiety	somatic anxiety	attention focusing	awareness about attention	wide internal attention	wide external attention	awareness during performance	internal speech	narrow external focus
mental energy	1	-,146	-,203	,556**	,445*	-,135	,614**	,268	,169	,666**
cognitive anxiety		1	,695**	-,437*	,193	,516**	-,240	-,124	,600**	-,113
somatic anxiety			1	-,338	,004	,304	-,345*	-,042	,366*	-,247
attention focusing				1	,230	-,244	,654**	,461**	,034	,480**
awareness about attention					1	,386*	,414*	,423*	,481**	,494**
wide internal attention						1	-,049	,087	,719**	,022
wide external attention							1	,441**	,109	,533**
awareness about attention during performance								1	,328	,287
internal speech									1	,155
narrow external focus										1

Legend: * correlation significant at $p < 0.05$; ** correlation significant at $p < 0.01$

In volleyball players, out of 45 correlations between variables of MUSI, included in this study, 25 of these correlations were statistically significant (five negative-directed, while the others were positive), and mainly low or moderate high (Table 2).

Table 3 – Correlations between the aspects of MUSI in female volleyball players

Volleyball players	mental energy	cognitive anxiety	somatic anxiety	attention focusing	awareness about attention	wide internal attention	wide external attention	awareness during performance	internal speech	narrow external focus
mental energy	1	,060	,192	,566**	,168	-,281*	,499**	,387**	,147	,368**
cognitive anxiety		1	,651**	-,190	,417**	,620**	-,151	-,312*	,602**	-,138
somatic anxiety			1	-,097	,359**	,431**	,025	-,070	,358**	,169
attention focusing				1	,151	-,581**	,853**	,598**	,016	,571**
awareness about attention					1	,208	,291*	,040	,437**	,249
wide internal attention						1	-,441**	-,481**	,531**	-,188
wide external attention							1	,559**	,069	,735**
awareness about attention during performance								1	-,154	,589**
internal speech									1	,127
narrow external focus										1

Legend: * correlation significant at $p < 0.05$; ** correlation significant at $p < 0.01$

DISCUSSION

The main findings in this study provide the information mostly about the similarities in examined psychological characteristics in these two sports. Extensive internal attention, somatic and cognitive anxiety are the dimensions with a number of negative associations with other characteristics in both samples, what is expected (all these characteristics are undesirable for sport success). Only statistically significant difference is found (somatic anxiety), as well as the similar profiles in the relationships between these characteristics, with only few more significant correlations found in volleyball players. However, the trend of higher scores in desirable direction (except for somatic and cognitive anxiety, and wide external attention) is found in female handball players. One of possible explanation should be the fact that handball players are slightly older than volleyball players. For this explanation is a little support, because the dimensions explored in wider study are not associated with age of athletes or their sport experience, in the larger sample of participants (Sindik et al, 2015). On the other hand, some studies suggest that scores in similar concentration scales indicate that concentration skills are improving with age (Nideffer& Bond, 2012; Kovářová&Kovář, 2010). Second explanation is the nature of two different sport games: handball is rough contact sport, while the volleyball is not (Cox, 2005): thus, higher level of desirable psychological characteristics, as well as high level of anxiety are expected. The advantage of this research is the application of these (new) questionnaires on two team sport games, for female athletes. The main shortcoming of the research is the fact that the number of participants is not representative (it is too small and covers at least athletes from one club for each sport, with age discrepancy). Moreover, the same competition level in these two sports, in spite of the fact that it is balanced, is not a guarantee that overall training and competitive requests are similar (neglecting the 'nature' of these sports in terms of contact etc.). Practical implication of this study could be focused on using this orientation standards (explained by means in certain characteristics), as useful information for sport coaches or sport psychologists, as the start point to develop individualized training programs to improve these skills (Nideffer& Bond, 2012).

CONCLUSIONS

The results obtained show that only in somatic anxiety is found one statistically significant difference between female handball and volleyball players, off all the dimensions of MUSI, in direction of higher means for

female handball players. In all other characteristics, no statistically significant differences were found, but with the trend of higher scores in desirable direction (except for somatic and cognitive anxiety), found in female handball players (as compared with volleyball players). Twenty significant correlations in handball and 25 in volleyball players are found, mostly positive direction and low to moderate high. The results provide the guidelines for sport coaches, giving insights into the similar profiles of psychological characteristics in these two sports, but with characteristic levels.

ACKNOWLEDGEMENTS

We are especially grateful to the athletes from all the clubs, who actively contributed in this research, or provide support for it, as well as for the psychologists Matej Fiškuš, M.S. and Anđelko Botica, M.S., who collected the data and contributed in formulating the items for the questionnaires.

REFERENCES

Abernethy, B., Summers, J.J. & Ford, S. (1998). Issues in the measurement of attention. In, J.L. Duda (Ed.) *Advances in sport and exercise psychology measurement* (pp. 173-193). Morgantown: Fitness Information Technology.

Cox RH, *Psihologijasporta*. Jastrebarsko: Naklada Slap, 2005.

Kovářová, L., Kovář, K. (2010). Concentration of attention as a predisposition of performance in junior categories in endurance sports. *Acta Universitatis Palackianae Olomucensis. Gymnica*, 40 (1), 23-31.

Lieberman, H.R. (2006). *Mental Energy: Assessing the Cognition Dimension*. *Nutrition Reviews*, 64 (7), 10-13.

McNair, D.M., Heuchert, J.W.P., & Shillony, E. (2003). *Research with the Profile of Mood States (POMS) 1964-2002: A comprehensive bibliography*. Toronto, Canada: Multi-Health Systems.

McNair, D.M., Lorr, M., & Droppleman, L.F. (1971). *Manual for the Profile of Mood States*. San Diego, CA: Educational and Industrial Testing Services.

Nideffer, R.M. (1976). Test of Attentional and Interpersonal Style. *Journal of Personality and Social Psychology*, 34, 394-404.

Nideffer, R.M., Bond, J. (2012). A Cross Cultural Examination of the Concentration Skills of Elite Level Athletes. Retrieved from: <http://www.epstais.com/articles/xcult.php> (2/1/2015).

Nideffer, R.M., Bond, J. Cei, A. &Manili, U. (2012). Building A Psychological Profile of Olympic Medalists and World Champions. Retrieved from: <http://www.taisdata.com/articles/building.php> (2/1/2015).

Norman, D.A. (1968). Toward a theory of memory and attention. *Psychological Review*, 75, 522-536.

O'Connor, P.J. (2006). Mental Energy: Assessing the Mood Dimension. *Nutrition Reviews*, 64(7), 7-9

Orlick, T. &Partington, J. (1988). Mental links to excellence. *The Sport Psychologist*, 2, 105-130.

Sindik, J., Botica, A., Fiškuš, M. (2015). Preliminary psychometric validation of the Multidimensional inventory of sport excellence: attention scales and mental energy. *Monten J Sports Sci Med*4(2) (in press).

Spielberger CD. *Manual for the State-Trait Anxiety Inventory (STAI)*. Palo Alto, CA: ConsultingPsychologists Press, 1983.

Association of hypohydration and rate of body mass reduction among elite youth amateur boxer

Damir Zubac, Vladimir Ivančev, Hrvoje Karninčić

Faculty of Kinesiology, University of Split, Croatia

ABSTRACT

The first aim of our study was to examine association of hydration status (USG assessment) and rate of body mass reduction (ROR), secondly we also examined prevalence of hypohydration and ROR among elite youth boxer. The participants were 24 boxers (all males; national team members; $16,83 \pm 1,01$ years of age) from three European countries, competing at the official tournament. The variables were collected by assessing urine specific gravity (USG) using digital refractometer and an anamnestic questionnaire asking subjects on sports factors; current weight class category, competitive experience and reduced body mass prior to a competition. ROR was calculated by dividing body mass with body mass reduced prior to competition. According to results shown in our study, USG was associated with subsequent body mass reduction ($R_s = 0,65, p < 0,01$). Notably, we found that the change in body mass explained very little of the variance in USG, only $r^2 = 42\%$. Moreover, high prevalence of hypohydration was found, almost 60% of participants were reported USG values $> 1,021$ g/ml, while the most abundant pattern of weight reduction was 2-5% of ROR reported by 50% of youth boxers. The official weigh-in at competition day did not prevent hypohydration in our study. Boxing authorities could reconsider official rules and regulation and advocate for implementing an official hydration assessment program aiming to discourage athletes from engaging in harmful weight loss procedures

Keywords: dehydration, weight cycling, combat sports

Introduction

Combat sports athletes' are historically associated with competing in weight class categories (WCC). Amateur boxing was the first combat sport

that introduced WCC in 1867 (Smith, 2006a). Weight cutting is a common practice in boxing with the purpose of taking advantage of rivals competing in weight divisions below the athlete's natural weight (Fernandez-Elias et al., 2014). Extreme restrictions in the consumption of food and beverages, training in rubber suits, improper use of a sauna, as well as the use of banned pharmacological agents are frequently reported weight cutting methods adopted by amateur boxer (Reljic, et al., 2013; Smith, 2006b). Detrimental negative health consequences, including death, are documented as a result of weight cutting, but this practice is still common in the majority of weight class combat sports (Franchini, et al. 2012).

Excessive weight-cycling practices during adolescence may affect body development through changes in endocrine mechanisms, such as testosterone release and growth factor linked to insulin-1 (Roemmich & Sinning, 1997). Furthermore, an eating disorder linked to weight making in junior boxers, in attempt to suppress his body weight and continue to box domestically was reported (Lovett, 1990). Higher prevalence of overweight and obesity in former combat athletes exposed to body mass manipulation in comparison with former athletes who were not weight cyclers during their competitive career was also reported (Saarni, et al. 2006).

Two terms related to hydration status are often mistakenly interchanged are dehydration and hypohydration. Dehydration was commonly defined as the dynamic loss of body water due to sweating over the course of exercise without fluid replacement, or a process in which fluid replacement is inadequate (Sawka et al., 2007). In contrast, hypohydration refers to a state or level of hydration after a loss of a certain amount of body water (Cheung, 2010). The consequent dehydration is assumed to be a major adverse effect associated with rapid loss of body mass in amateur boxing (Reljic et al., 2013). Likewise, the resultant state of hypohydration could adversely affect health and performance outcomes (Fernandez-Elias et al., 2014; Maughan, 2003).

To best of our knowledge, only two papers had been published addressing hydration status of amateur boxers in real-life settings (Pettersson & Berg, 2014; Zubac et al., 2015). Moreover, we failed to find a study reporting association of consequential body mass reduction and hydration status in prior to official competition in youth boxers. Therefore, the first aim of our study was to examine the association of hypohydration and rate of body mass reduction (ROR), secondly, we also examined the prevalence of hypohydration and ROR among elite youth boxer.

METHODS

Our study was carried out as part of a preparation bouts between national teams prior to the official World Youth Championship held in April 2014, Sofia, Bulgaria. The participants included in our study were elite youth boxers, national team members of Croatia, Hungary and Germany (N=24; 16,83±1,01 years old, 176,58±8,67 cm, 70,41±16,01 kg, 10,49±2,51 % of body mass expressed as fat, 5,83±1,58 boxing experience, 2,46±2,14 ROR). Participation was voluntary, with written permission from national team managers. Our study was approved by the authors' Institutional Research Ethical Board in accordance with the Helsinki Convention. The participation criteria was current national champion with international boxing experience (>25 fights).

PROTOCOL

In agreement with American College of Sports Medicine's (ACSM) hydration testing guidelines, (Sawka et al., 2007) each participant was instructed to provide a small urine sample collected mid flow from the first void in the morning of the competition day. The urine specific gravity (USG) is reflecting upon pre-competition hydration status. The cut-off was based on these organizations' guidelines regarding hydration status: USG <1.010 indicates a well-hydrated state, USG =1.010–1.020 indicates minimal hypohydration, USG >1.021 indicates significant hypohydration, and USG >1.030 indicates serious hypohydration. The limit for minimal hypohydration might be too strict for initial morning void measurements due to the insensible water losses, an absence of fluid intake, and decreased glomerular filtration during sleep. Therefore, a first-morning USG >1.020 is suggested to point toward a state of hypohydration (Sawka et al., 2007). Moreover, USG has even been suggested as a superior index to detect hypohydration following overnight sleep without fluid intake (Hamuti et al., 2013).

The assessment was performed prior to Croatia-Germany and Croatia-Hungary matches within a seven-day period. Athletes did not train for 24 hours before sampling and were asked not to consume any medications or dietary supplements. The temperature and relative humidity in the testing facility ranged from 16–19°C and 50–55%, respectively, for all trials. Due to the exceptional competitiveness within the Croatian team (i.e. during 2013-2014 youth team won a total of eight medals in four different WCC competing at major AIBA tournaments) the Croatian national team manager decided

to try out a combined lineup in bout against Hungary and introduced new participants who were not eligible for our survey due to strict inclusion criteria.

The official weigh-in was scheduled for 9 a.m. Participants handed out their urine specimens before weigh-in and after weigh-in they approached the anthropometric measurement. Sample of variables in this study also consisted of anthropometric variables and data collected by extensive questionnaire (QWC). The QWC was combined of previously used questionnaires where athletes from different combat sports were tested on similar issues (Artioli et al., 2010; Brito et al., 2012; R. Kordi, et al., 2011). The instrument had undergone content validity by three researchers before the final draft. Throughout the questionnaire, participants were asked on anamnestic data of sport-factors: competitive experience, current weight class category, and body mass reduced prior to this particular competition (in kg).

Additionally, we calculated the ROR for each single competitor. More precisely, the self-reported average value of body mass for each WCC was divided with self-reported body mass reduced prior to competition as suggested previously (Casa et al., 2000). The USG was analyzed by an AtagoPal 10s refractometer (Tokyo, Japan) providing accurate readings to 0.001 units. The refractometer was calibrated with distilled water before usage. A glass pipette was used to apply the urine sample to the instrument and the value was digitally read. The RF determined the USG in a range from 1.000 to 1.060; the deflection in the scale was 0.001. The percentage of body mass expressed as fat was calculated according to the protocol previously used in research applied to youth boxer (Reljic et al., 2013). Body mass was measured by official Tanita BC 520 scale (correctness of results 0.1 kg), body height was measured by a Martin's anthropometer (correctness of results 0.1 cm).

STATISTICS

We analyzed data via descriptive statistics of the distribution of variables (mean and standard deviation). The normality of the distribution was tested using Shapiro–Wilk. For determining the association among USG and rate of body mass reduction Spearman's range of correlation was used, because the rate of body mass reduction violated the normality assumption. Frequencies of USG and ROR were also calculated. The data were analyzed using Statistica v.12.0 (StatSoft, SAD) package and MS Office 2013. Statistical significance was set at $p < 0,01$.

RESULTS

Reliability analyses showed appropriate reliability of the testing. Spearman's R was 0,99 (ROR), while percentage of equally responded queries ranged from 0,90 % (competitive experience)-100,0 % (current WCC).

Figure 1

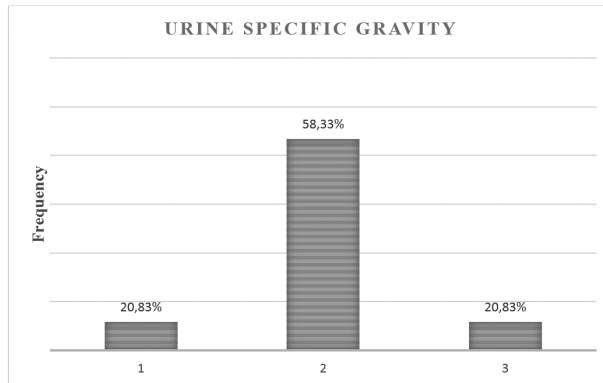

Categorization of different levels of hypohydration in elite youth boxer (n=24); USG values in the first chart bar indicate minimal hypohydration ranging from 1.010–1.020; USG >1.021 values in the second chart bar indicate significant hypohydration, and USG >1.030 values in the third chart bar indicate serious hypohydration on competition day

Figure 2

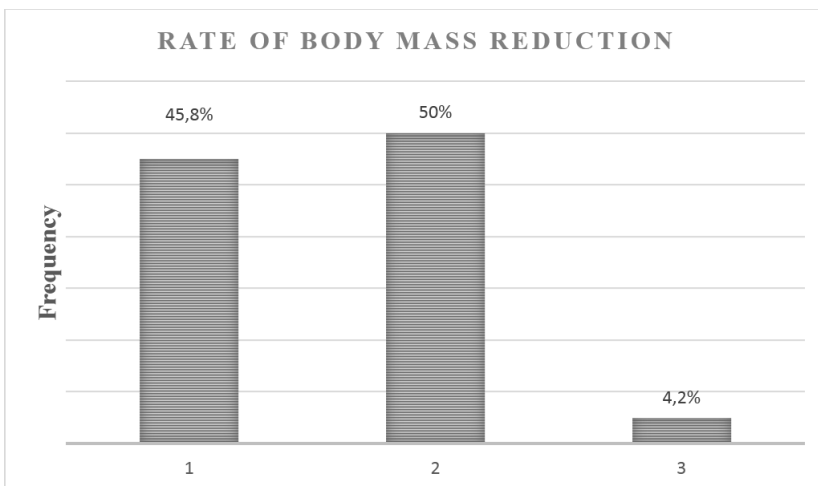

Categorization of different levels of rate of body mass reduction expressed in percentage in elite youth amateur boxer (n=24); Values in first chart bar indicates minimal body mass reduction up to 2%, value in second chart bar indicates significant body mass reduction 2-5 %, and values reported in the third chart bar indicates serious body mass reduction of >5%

Figure 3.

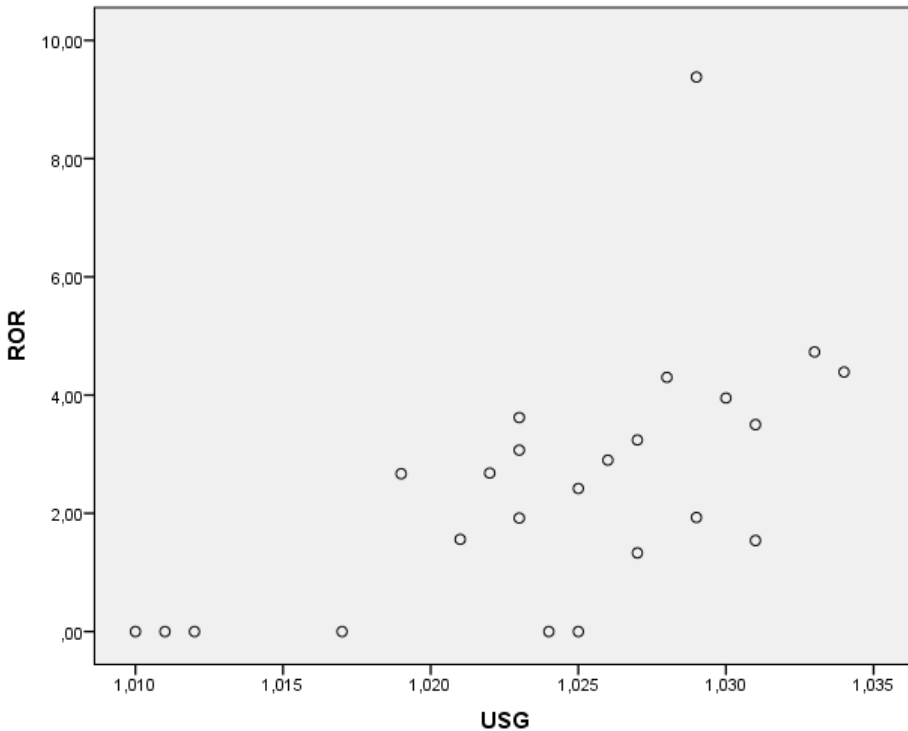

The relationship between subsequent USG values and rate of body mass reduction expressed percentage ($R_s = 0,65, p < 0,01; N = 24$).

DISCUSSION

To the best of our knowledge, this was the first study that examined the association between hypohydration (USG assessment) and ROR in elite youth boxer, ($R_s = 0,65, p < 0,01; N = 24$). Moreover, we found high prevalence of hypohydration. Almost 60% of participants exceed USG cut of point >1,021 g/ml, while the most abundant pattern of weight reduction was 2-5% of body mass reduced, reported by nearly 50% of youth boxers. The most important findings will be discussed in the following text.

Notably, weight cutting practice is studied among different combat sports (Brito et al., 2012; Kordi, et al. , 2011), but studies rarely report association of consequential body mass loss and hypohydration on competition day. Spearman's range of correlation was used to demonstrate an association between hypohydration (USG) and ROR. According to results presented (Figure 3.), USG was associated with subsequent body mass reduction ($R_s = 0,65$, $p < 0,01$). We found that the self-reported change in body mass explained very little of the variance in hydration status, only $r^2 = 42\%$. Such finding were unexpected and inconsistent with suggestions of (Casa et al., 2000). One possible mechanism accountable could be that, even if USG is broadly advocated as superior method in field assessment of hydration status (Pettersson & Berg, 2014), in order to obtain a far more precise information on pre-competition hydration status of athletes, urine concentration and water balance should be addressed simultaneously, due to close loop system of regulatory neuroendocrine mechanisms, as advocated by (Armstrong, 2007).

We found that only 20% of participating youth amateur boxer had an upon-waking USG ≤ 1.020 g/ml, a value suggestive of being euhydrated (Casa et al., 2000). Nearly 60% of our participant's were reported significantly hypohydrated, exceeding ACMS cut off point $> 1,020$ g/ml. Our data are similar to previous findings of Swedish authors who reported prevalence of serious hypohydration prior to competition, in almost 50% of elite senior boxers and judokas (Pettersson & Berg, 2014). Likewise, nearly half of the athletes in current study were seriously hypohydrated (USG > 1.030 g/ml). Common wisdom suggests that such finding should be corresponding to a $> 5\%$ body mass loss (Casa et al., 2000) on the morning of competition day as an indicator of hydration status. On the contrary, our findings of serious hypohydration did not correspond to self-reported values of $> 5\%$ body mass loss (see Results). However, currently suggested cut off point for USG should not be not be generalized. Buford et al. (2006) suggested that wrestlers seem to have higher USG values even when euhydrated. Moreover, to support this theory, recently Reljić et al., (2015) demonstrated that regardless of body water and plasma volume decreasment, USG still tended to increase, after rapid weight loss in elite combat athletes. Therefore, physiological mechanisms underlying this phenomenon in combat athletes are unclear and requires further investigation.

The most abundant pattern of ROR reported was 2-5 % of body mass reduced during final preparation for this competition. Nearly 50% of participants were reported. Smith (2006a) suggested that English youth boxers experience large

fluctuations in body mass during a period of growth and maturation. Our findings are in line with such report. Furthermore, official weigh-in at competition day did not prevent hypohydration in our study, therefore our data are also supportive to recent report of Pettersson and Berg (2014). Thus, Olympic combat sports athletes with serious hypohydration in the morning risk to commence match in a hypohydrated state under the current structure and rules in use at competitions. Sport governing authorities should seriously consider implementing an official hydration assessment program aiming to discourage athletes from engaging in the harmful weight loss practice. Impaired physiological processes, health risks associated with harmful weight cutting protocols justify the need for screening and detecting consequential dehydration.

We could be criticized for not accounting for laboratory analysis of pathological changes of the urine sample. Furthermore, this investigation is partially based on self-reported data and the subjects might not have told the truth, especially if they felt uncomfortable. However, we believe that the testing design (see Methods), the fact that testing was done by “insider” (one of the authors of the paper is former boxer and current boxing coach) and our experience gained from previous studies decreased this possibility.

CONCLUSION

The first aim of our study was to examine the association of hydration status (USG) and ROR, secondly we investigated the prevalence of hypohydration and rate of body mass reduction among elite youth boxer. We found a significant association between USG and ROR. Notably, we found only 42 % of the common variance between USG and ROR. Secondly, official weight in did not prevent the prevalence of hypohydration. Therefore, an introduction of systematic monitoring of hydration status may be a promising tool that could lead to improvement in athletic performance, but also a significantly reduce their health risk in amateur boxing. Novel investigation should address the relation of hydration status and body mass reduction in a more comprehensive manner, in order to establish facts and reach new conclusions.

References:

Armstrong, L. E. (2007). Assessing hydration status: the elusive gold standard. *Journal of the American College of Nutrition*, 26, 575S-584S.

Artioli, G. G., Gualano, B., Franchini, E., Scagliusi, F. B., Takesian, M., Fuchs, M., & Lancha, A. H., Jr. (2010). Prevalence, magnitude, and methods of rapid weight loss among judo competitors. *Medicine and Science in Sports and Exercise*, 42, 436-442.

Brito, C. J., Roas, A., Brito, I. S. S., Marins, J. C. B., Córdova, C., & Franchini, E. (2012). Methods of body mass reduction by combat sports athletes. *International Journal of Sport Nutrition and Exercise Metabolism*, 22, 89-97.

Buford, T. W., Rossi, S. J., Smith, D. B., O'Brien, M. S., & Pickering, C. (2006). The effect of a competitive wrestling season on body weight, hydration, and muscular performance in collegiate wrestlers. *Journal of Strength Conditioning Research*, 20, 135-138

Casa, D. J., Armstrong, L. E., Hillman, S. K., Montain, S. J., Reiff, R. V., Rich, B. S. E., Stone, J. A. (2000). National Athletic Trainers' Association position statement: Fluid replacement for athletes. *Journal of Athletic Training*, 35, 212-224.

Cheung, S. S. (2010). *Advanced Environmental Exercise Physiology; Human Kinetics*. Illinois, USA

Fernandez-Elias, V. E., Martinez-Abellan, A., Lopez-Gullon, J. M., Moran-Navarro, R., Pallares, J. G., De la Cruz-Sanchez, E., & Mora-Rodriguez, R. (2014). Validity of Hydration Non-Invasive Indices during the Weight cutting and Official Weigh-In for Olympic Combat Sports. *PLoS ONE*, 9, e95336

Franchini, E., Brito, C. J., & Artioli, G. G. (2012). Weight loss in combat sports: physiological, psychological and performance effects. *Journal of the International Society of Sports Nutrition*, 9, 6

Hamouti, N., Del Coso, J., & Mora-Rodriguez, R. (2013). Comparison between blood and urinary fluid balance indices during dehydrating exercise and the subsequent hypohydration when the fluid is not restored. *European Journal of Applied Physiology*, 113, 611-620.

Kordi, R., Ziaee, V., Rostami, M., & Wallace, W. A. (2011). Patterns of weight loss and supplement consumption of male wrestlers in Tehran. *Sports medicine, arthroscopy, rehabilitation, therapy & technology. Sports Medicine, Arthroscopy, Rehabilitation, Therapy and Technology*, 3, 4.

Lovett, J. (1990). Bulimia nervosa in an adolescent boy boxer. *Journal of adolescence*, 13, 79-83.

Maughan, R. J. (2003). The impact of mild dehydration on wellness and on exercise performance. *European Journal of Clinical Nutrition*, 57 (Suppl 2), S19-23.

Oppliger, R. A., Steen, S. A. N., & Scott, J. R. (2003). Weight loss practices of college wrestlers. *International Journal of Sport Nutrition and Exercise Metabolism*, 13, 29-46.

Petterson, S., & Berg, C. M. (2014). Hydration Status in Elite Wrestlers, Judokas, Boxers, and Taekwondo Athletes on Competition Day. *International Journal of Sport Nutrition and Exercise Metabolism*, 24, 267-275.

Reljic, D., Hassler, E., Jost, J., & Friedmann-Bette, B. (2013). Rapid Weight Loss and the Body Fluid Balance and Hemoglobin Mass of Elite Amateur Boxers. *Journal of Athletic Training*, 48, 109-117

Reljic, D., Feist, J., Jost, J., Kieser, M., & Friedmann-Bette, B. (2015). Rapid body mass loss affects erythropoiesis and hemolysis but does not impair aerobic performance in combat athletes. *Scandinavian Journal of Medicine & Science in Sports*. doi: 10.1111/sms.12485

Roemmich, J. N., & Sinning, W. E. (1997). Weight loss and wrestling training: Effects on nutrition, growth, maturation, body composition, and strength. *Journal of Applied Physiology*, 82, 1751-1759.

Saarni, S. E., Rissanen, A., Sarna, S., Koskenvuo, M., & Kaprio, J. (2006). Weight cycling of athletes and subsequent weight gain in middle-aged. *International Journal of Obesity*. 30,1639-1644.

Sawka, M. N., Burke, L. M., Eichner, E. R., Maughan, R. J., Montain, S. J., & Stachenfeld, N. S. (2007). Exercise and fluid replacement. *Medicine and Science in Sports and Exercise*, 39, 377-390.

Smith, M. S. (2006a). Physiological profile of Senior and junior England international amateur boxers. *Journal of Sports Science and Medicine*, 5, 74-89.

Zubac, D., Karnincic, H., & Zaja, M. (2015). Hydration status assessment among elite youth amateur boxers. *The Journal of Sports Medicine Physical Fitness*. (ahead-of-print)

Utjecaj nekih motoričkih sposobnosti na vođenje lopte u vaterpolu

Alma Dizdar¹, Edin Mirvić², Faris Rašidagić²

¹*Olimpic swimming pool Sarajevo, Bosnia and Herzegovina*

²*Faculty of Sports and Physical Education,
University of Sarajevo, Bosnia and Herzegovina*

SAŽETAK

The main objective of this research is to determine and explain the impact of some motor skills on dribbling in water polo players aged 13 to 15 years. The sample consists of 70 male water polo players, aged 13-15, from the following water polo clubs from Sarajevo Canton: Water Polo Club Akademija, Water Polo Club Torpedo, Water Polo Club Mladost Sarajevo and Water Polo Club Dabar. Sample of predictor variables from the area of basic motor skills of water polo players was measured using the tests: agility in air, hand tapping, foot tapping, reach on the beam, sit and reach, transverse standing on a low beam, running 20m from a standing start, triple jump, standing long jump, bar hanging, sit-ups in 30 seconds, push-ups on the parallel bars; criterion variable - dribbling 3x5m. It can be concluded that body coordination and rational performance of complex motor skills has a major impact on the dribble 3x5m. Also, coordination allows to a certain extent, to compensate the lack of other motor skills.

Ključne riječi: water polo players, dribbling, regression analysis.

UVOD

Motoričke sposobnosti čovjeka učestvuju u rješavanju motornih zadataka i uvjetuju uspješno kretanje bez obzira da li su stečene treningom ili ne. U motoričke sposobnosti se ubrajaju: snaga, brzina, izdržljivost, koordinacija, fleksibilnost, ravnoteža i preciznost (Malacko, Rađo, 2004). U igri se služe

različitim tehnikama kretanja, bez i s loptom (Trumbić, 2010). U zadnjih deset godina došlo je do određenih promjena u pravilima igre kao što je trajanje vremenskog napada sa 35 na 30 sekundi, i skraćenog vremena napada s igračem više sa 25 na 20 sekundi što zahtjeva brže plivanje sa i bez lopte. Na mladim vaterpolistima istraživana je utjecaj procesa treninga na razvoj nekih bazičnih motoričkih sposobnosti (Šimenc i sar. 1990). U svom istraživanju autori Dopsaj et al. (2007) bavili su se procjenom usvojenosti različitih modaliteta plivanja kraul tehnike kod vaterpolista u funkciji uzrasta i takmičarskog nivoa. Rezultati su pokazali da postoji generalna statistički značajna razlika između datih plivačkih testova između posmatranih uzoraka u odnosu na takmičarski nivo, u odnosu na uzrasne grupe, kao i u odnosu na takmičarsku kategoriju u funkciji uzrasnih grupa. D'Ercole, A.A. et al. (2013) u svom istraživanju su testirali slalom i kontrolu lopte u situacijskim uslovima u plivanju na dužini od 20 m maksimalnom brzinom kod dvije različite grupe (početnici i iskusni vaterpolisti). Međutim, završni testovi nisu bili značajno različiti kod početnika u odnosu na stručne igrače, dok pojedinačna diskriminacijska analiza je identifikovala poboljšanja u igrača početnika, što nam omogućava da razlikujemo 2 grupe, jedna s višim stopama učenja i druga sa nižim stopama učenja. Falk B. et al. (2004) imali su za cilj da identifikuju varijable plivanja, rukovanja loptom i fizičke sposobnosti, kao i igračku inteligenciju, koja bi mogla pomoći u procesu selekcije mladih vaterpolista. Došli su do zaključka da treba manje posvetiti pažnje plivanju u procesu selekcije mladih vaterpolista a veći naglasak treba staviti na ocjenu igračke inteligencije. Osnovni cilj ovog istraživanja je utvrđivanje i objašnjavanje utjecaja nekih motoričkih sposobnosti na vođenje lopte u vaterpolu, vaterpolista uzrasta od 13 do 15 godina.

METODE ISTRAŽIVANJA

Uzorak ispitanika

Uzorak ispitanika čine 70 vaterpolista muškog spola, starosti 13–15 godina, iz sljedećih vaterpolo klubova Kantona Sarajevo i to: Vaterpolo klub *Akademija*, Vaterpolo klub *Torpedo*, Vaterpolo klub *Mladost Sarajevo* i Vaterpolo klub *Dabar*.

Uzorak varijabli

Uzorak prediktorskih varijabli iz prostora bazično-motoričkih sposobnosti vaterpolista izvršeno je pomoću testova prema Kurelić i saradnici, (1975) i testova Eurofit baterije (1988) i to:

- a) Mehanizam za strukturiranje kretanja koji predstavlja koordinaciju i frekvenciju pokreta
1. Okretnost u zraku
 2. Taping rukom
 3. Taping nogom
- b) Mehanizam sinergijske regulacije i regulacije tonusa što predstavlja motorički sposobnost fleksibilnosti i ravnoteže
1. Duboki pretklon na klupici
 2. Dohvat u sjedu
 3. Poprečno stajanje na niskoj gredi
- c) Mehanizam regulacije intenziteta ekscitacije što predstavlja motorički sposobnost brzina, eksplozivne snage
1. Trčanje 20m iz visokog starta
 2. Troskok iz mjesta
 3. Skok udalj iz mjesta
- d) Mehanizam regulacije trajanja ekscitacije što predstavlja motorički sposobnost repetativne snage i statičke snage.
1. Vis u zgibu
 2. Dizanje trupa za 30 sekundi
 3. Sklekovi na razboju
- Kriterijska varijabla:
1. Vođenje lopte 3x5m

PROCEDURA

Istraživanje je realizirano na redovnom treningu u istim uslovima potrebnim za testiranje sa istim planom i programom. Testiranje motoričkih sposobnosti i vođenja lopte 3x5m je izvršeno u Olimpijskom bazenu Otoka. Procedura testiranja vođenja lopte 3x5m je sprovedena na način: prostor za mjerenje je označen na sredini vaterpolo terena od 5 metara, ispitanik se nalazi na prvoj označenoj crti u osnovnom položaju, mjerilac pištaljkom označava start, a ispitanik startom kreće u realizaciju zadatka. Ispitanik ispliva prvu dionicu od 5 metara i zaustavlja se kod označene linije, okreće se za 180 stepeni i tako nastavlja plivati. Zadatak se završava kada ispitanik ispliva treću dionicu dodirujući stazu. Rezultati su mjereni u desetinkama sekunde.

Metode obrade podataka

Za utvrđivanje utjecaja nekih motoričkih sposobnosti na vođenje lopte, primijenjena je regresijska analiza koristeći statistički paket SPSS 12 for windows.

REZULTATI

Deskriptivnom statistikom (Tabela 1) pojedinačnim pregledom i analizom varijabli, može se utvrditi sljedeće: Okretnost u zraku je varijabla koja u sebi akumulira koordinaciju pokreta cijelog tijela. Na osnovu dobivenih rezultata može se vidjeti da, vrijednost aritmetičke sredine (Mean) iznosi 6,23, raspon (Min.-Max.) iznosi od 4,88 do 10,16, što se manifestuje dobrim rezultatom i potvrđuje standardnom devijacijom (Std. Dev.) koja iznosi 1,16. Zakrivljenost (Skewness) pokazuje blago grupisanje rezultata u pozitivnom dijelu koordinatnog sistema, a izduženost (Kurtosis) je u granicama normalne distribucije. Sve ovo ukazuje na to, da vaterpolisti imaju dobru koordinaciju, što je i razumljivo za sport kojim se bave, a što se može zaključiti iz testova koordinacije. Iz tabele se također može zaključiti, da u ovom istraživanju distribucija nimalo ne odstupa od normalne i da ova varijabla ima dobro raspoređene rezultate koji se mogu uzeti u dalje razmatranje. Taping rukom je varijabla koja u sebi akumulira brzinu i koordinaciju pokreta ruku. Vrijednost aritmetičke sredine (Mean) iznosi 44,17 a raspon minimalnog i maksimalnog rezultata iznosi 28 do 50 sa standardnom devijacijom (Std. Dev.) koja iznosi 4,51. Vrijednosti skewnessa i kurtosisa su u normalnim granicama što govori da je distribucija rezultata normalno raspoređena i može se uzeti dalje u razmatranje. Vaterpolisti imaju dobre rezultate u ovoj varijabli jer imaju specifičan program rada koji zahtijeva često upotrebu ruku što je doprinijelo dobrim pokazateljima u testu taping rukom. Taping nogom je varijabla koja također u sebi akumulira brzinu i frekvenciju pokreta nogu. Ova varijabla ima sljedeće vrijednosti: aritmetička sredina (Mean) iznosi 25,25, raspon (Min.-Max.) iznosi od 19 do 31, standardna devijacija (Std.Dev.) iznosi 2,62 a mjere zakrivljenosti (Skewness) i zaobljenosti (Kurtosis) iznose -,10 i ,53 što znači da varijabla ima normalnu distribuciju i može se uzeti u dalje razmatranje. Duboki pretklon na klupici je varijabla koja govori o fleksibilnosti tijela. Distribucija rezultata nije najbolje raspoređena što se može vidjeti iz vrijednosti Kurtosisa koji iznosi 3,09, ali se rezultati mogu uzeti u obzir jer se nalaze na graničnoj vrijednosti normalne distribucije. Vrijednosti Skewnessa pokazuju pozitivnu zakrivljenost (2,06) rezultata i u normalnim i dozvoljenim su granicama tako da se dalje razmatranje ove varijablje može uzeti u obzir. Razlog lošije distribucije rezultata ove varijable može biti u tome da vaterpolisti inače nemaju pretjerano dobru fleksibilnost zbog vertikalnog položaja tijela i ne tako čestog savijanja tijela. Dohvat u sjedu je varijabla koja također govori o fleksibilnosti. Za razliku

od prethodne varijable, ova varijabla ima normalnu distribuciju čiji rezultati pokazuju negativnu zakrivljenost (-,23) i zaobljenost (-,19). Vrijednost aritmetičke sredine iznosi 36,01, raspon rezultata minimalne i maksimalne vrijednosti iznosi od 12 do 58, standardna devijacija iznosi 11,13. Ova varijabla je normalna i uzima se u dalje razmatranje. Poprečno stajanje na niskoj gredi je varijabla koja govori o sposobnosti održavanja ravnoteže u otežanim uvjetima i varijabla je sa normalnom distribucijom koja se uzima u dalje razmatranje. Rezultati pokazuju pozitivnu zakrivljenost i zaobljenost. Trčanje 20m iz visokog starta je varijabla koja govori o eksplozivnoj snazi, tačnije o brzini trčanja. Vrijednosti rezultata ove varijable nisu baš najbolje raspoređene, ali pripadaju normalnoj distribuciji i mogu se uzeti u razmatranje. Mjere zaobljenosti (Skewnessa) pokazuju pozitivnu asimetriju rezultata dok vrijednosti spljoštenosti (Kurtosis) pokazuju negativnu asimetriju čiji su rezultati izrazito heterogeni. Troskok iz mjesta je varijabla koja također govori o eksplozivnoj snazi čiji rezultati nisu najbolje raspoređeni po distribuciji, ali pripadaju vrijednostima sa normalnom distribucijom i mogu se uzeti u dalje razmatranje. Skok u dalj iz mjesta je varijabla koja također pripada grupi varijabli koje govore o eksplozivnoj snazi. Varijabla je normalno raspoređena, a rezultati pokazuju negativnu zakrivljenost i spljoštenost. Vis u zgibu je varijabla koja govori o statičkoj snazi, rezultati pokazuju pozitivnu zakrivljenost i spljoštenost, ali su malo udaljeniji nego kod prethodne varijable. Međutim varijabla je normalno distribuirana i može se dalje razmatrati. Dizanje trupa za 30 sekundi je varijabla koja govori o repetativnoj snazi trbušne muskulature. Ima normalnu ditribuciju i može se uzeti u obzir. Vrijednosti zaobljenosti (Skewnessa) i spljoštenosti (Kurtosisa) su pozitivne i blizu su raspoređene. Sklekovi na razboju je varijabla koja također govori o repetativnoj snazi, ali u ovom slučaju o snazi ruku. Varijabla je sa normalnom distribucijom čije vrijednosti pokazuju pozitivnu zaobljenost (Skewness iznosi 1,16) i spljoštenost (Kurtosis iznosi ,79) rezultata. Vođenje lopte 3x5m – VOL3X5 je varijabla koja također pokazuje normalnu distribuciju što se vidi iz dobivenih rezultata i uzima se u dalje razmatranje u ovom istraživanju. Na osnovu dobivenih rezultata centralnih i disperzionih parametara varijabli za procjenu motoričkih sposobnosti vođenja lopte 3x5m, može se zaključiti da su vrijednosti svih varijabli normalno distribuirane i da se mogu uzeti u dalje razmatranje u ovom istraživanju.

Tabela 1. Centralni i disperzioni parametri motoričkih sposobnosti i vođenja lopte 3X5 metara

	Valid N	Mean	Median	Min	Max	Range	Variance	Std.Dev.	Standard Error	Skewness	Kurtosis
Okretnost u zraku	70	6,23	5,78	4,88	10,16	5,28	1,34	1,16	,15	,84	,67
Taping rukom	70	44,17	45	28	50	22	20,38	4,51	,57	-1,07	1,88
Taping nogom	70	25,25	25	19	31	12	6,85	2,62	,33	-,10	,53
Duboki pretklon na klupici	70	2,87	,07	0	20	20	34,50	5,87	,75	2,06	3,09
Dohvat u sjedu	70	36,01	36	12	58	46	123,79	11,13	1,41	-,23	-,19
Poprečno stajanje na niskoj gredi	70	10,18	9,3	5,04	21,56	16,52	14,99	3,87	,49	1,42	2,23
Trčanje 20m iz visokog starta	70	3,26	3,09	2,81	3,84	1,03	,15	,38	,05	,26	-1,48
Troskok iz mjesta	70	590,45	625	401	647	246	4320,91	65,73	8,35	-1,75	2,40
Skok u dalj iz mjesta	70	199,61	212,25	122,5	226	103,5	734,27	27,10	3,44	-,79	-,65
Vis u zgibu	70	36,58	38,87	3	65,63	62,63	220,94	14,86	1,89	,65	,07
Dizanje trupa za 30 sekundi	70	20,95	22	14	26	12	11,16	3,34	,42	-,50	-,99
Sklekovi na razboju	70	5,38	5	1	12	11	8,90	2,98	,38	1,16	,79
Vođenje lopte 3x5m	70	16,36	15,22	11,13	27,5	16,37	13,62	3,69	,47	1,26	1,37

Regresijska analiza kriterijske varijable Vođenje lopte 3x5m (Tabela 2), pruža dovoljno informacija o utjecaju primijenjenih motoričkih varijabli na uspjeh izvođenja tretirane kriterijske varijable. Povezanost prediktora

sa kriterijskom varijablom je $R = .650$, a objašnjeno je 43% zajedničkog varijabiliteta sa kriterijem. Takva povezanost je značajna na nivou $.003$. Analizom utjecaja pojedinačnih motoričkih varijabli, može se vidjeti da najveći i statistički značajan utjecaj na kriterijsku varijablu ima samo varijabla Okretnost u zraku sa graničnom vrijednošću do $.05$. Ostale motoričke varijable nisu pokazale statističku značajnost, ali ne možemo pričati o uspjehu vođenja lopte bez cjelokupnog skupa motoričkih sposobnosti. Zbog toga motoričke sposobnosti imaju veliki značaj i doprinos u rješavanju situaciono motoričkih sposobnosti u vaterpolu.

Tabela 2. Regresiona analiza varijable vođenje lopte 3x5m

R=,650, R Square=,422; Adjusted R Square=,280; F=2,980, Sig.= ,003					
	B	Std. Error	Beta	t	Sig.
Okretnost u zraku	,97	,48	,30	2,00	,05
Taping rukom	,19	,14	,24	1,34	,18
Taping nogom	-,36	,26	-,25	-1,37	,17
Duboki pretklon na klupici	-,18	,09	-,28	-1,87	,06
Dohvat u sjedu	-,11	,05	-,33	-1,88	,06
Poprečno stajanje na niskoj gredi	,16	,14	,16	1,12	,26
Trčanje 20m iz visokog starta	-1,55	1,28	-,16	-1,21	,23
Troskok iz mjesta	,00	,00	,05	,36	,71
Skok u dalj iz mjesta	-,03	,02	-,28	-1,52	,13
Vis u zgibu	-,09	,06	-,38	-1,52	,13
Dizanje trupa za 30 sekundi	-,00	,14	-,00	-,02	,97
Sklekovi na razboju	,42	,31	,34	1,35	,18

DISKUSIJA

Osnovni cilj ovog istraživanja bio je utvrđivanje i objašnjavanje utjecaja nekih motoričkih sposobnosti na vođenje lopte u vaterpolu, vaterpolista uzrasta od 13 do 15 godina. U svom istraživanju autori Modrić et al. (2011) su utvrdili metrijske karakteristike četiri novokonstruirana testa za procjenu koordinacije kod vaterpolista. Ovo istraživanje navedenih autora dalo je veće

bogatstvo i olakšalo dalja istraživanja u prostoru motoričkih sposobnosti – koordinacije, a poznato je da je koordinacija veoma bitna u vaterpolu. Slična istraživanja su sprovedi u vaterpolu Aleksandrović et al. (2011) koji su istraživali bateriju testova plivanje na 25, 50, 100, 4x5, 3x5 metara, gdje se pokazala visoka korelacija situacionih motoričkih sposobnosti vaterpolista kao i motoričkih sposobnosti. Ovi testovi se mogu koristiti u testiranju transverzalnog stanja vaterpolista u predtakmičarskom periodu. Garrido et al. (2010) je dokazao da bazična motorička sposobnost ima značajnu povezanost sa brzinom plivanja kod vrhunskih plivača. Također, u literaturi nailazimo na pojmove situaciona i specifična koordinacija (Sekulić i Metikoš 2007; Metikoš i sar., 2003).

ZAKLJUČAK

Na osnovu postavljenog osnovnog cilja istraživanja i na osnovu dobivenih rezultata može se zaključiti da veliki utjecaj na vođenje lopte 3x5m zauzima koordinacija tijela koju definiramo kao sposobnost vremenski i prostornog efikasnog, te energetski racionalnog izvođenja kompleksnih motoričkih zadataka i praktično učestvuje u realizaciji svake kretne strukture, od najjednostavnijih do najsloženijih oblika gibanja. Također, ona omogućava da se u određenoj mjeri, u određenim situacijama kompenzira nedostatak nekih drugih motoričkih sposobnosti. Koordinacija je izuzetno složena motorička sposobnost i nije određena samo jednim faktorom, već ima mnogo različitih manifestacija: koordinacija ruku, nogu, tijela, brzina izvođenja kompleksnih motoričkih zadataka, reorganizacija stereotipa kretanja, agilnost, brzina učenja novih motoričkih sposobnosti, koordinacija u ritmu i tajming. Često se u toku same vaterpolo igre dešavaju promjene pravca i smjera kretanja, koje iziskuju od vaterpolista da u što kraćem vremenskom roku promijeni svoj položaj tijela, npr. iz položaja na prsima doći u položaj na leđima da bi se uspješno izvršila zamišljena akcija ili kontrakcija. Rezultati istraživanja mogu se koristiti prilikom konstruiranja baterije mjernih instrumenata kojima se mogu dobiti kvalitetne informacije prilikom planiranja i programiranja treninga, selekcije, usmjeravanja i usavršavanja za određivanje pozicije u igri, kao i za izradu periodizacije treninga kako u godišnjim, tako i u polugodišnjim ciklusima treninga, pri izradi plana i programa svakog pojedinog treninga. Testiranjem motoričkih i situaciono–motoričkih sposobnosti vaterpolista može se uspješno pratiti njihov razvoj a dobivene rezultate trener može primijeniti u svakom daljem trenažnom radu tako što će uspješno vršiti sve potrebne korekcije bez improvizacije i "lutanja".

LITERATURA

Aleksandrović, M., Radovanović, D., Okičić, T., Madić, D., and Georgiev, G. (2011) Functional Abilities as a Predictor of Specific Motor Skills of Young Water Polo Players, Sep; 29: 123–132, *J Hum Kinet*.

Aleksandrović, M., Naumovski, A., Radovanović, D., Georgiev, G., Popovski, D. (2007). The influence of basic motor abilities and anthropometric measures on the specific motor skills of talented water polo players. *Facta Universitatis, Series: Physical Education and Sport*, vol. 5, N° 1, pp.65-77.

DERcole, A.A., DERcole, C., Gobbi, M., Gobbi, F. (2013). Technical, perceptual and motor skills in novice-expert water polo players: an individual discriminant analysis for talent development. *Journal of strength and conditioning research/ National Strength & Conditioning Association* 27(12):3436-44.

Dopsaj, M., Madić, D., Okičić, T. (2007). The assessment of the acquisition of various crawl style modes in water polo players with respect to age and competitive levels. *Facta Universitatis, Series: Physical Education and Sport*, vol 5; N° 2, pp. 109-120.

Falk B., Lidor, R., Lander, Y., Lang, B. (2004). Talent identification and early development of elite water-polo players: a 2-year follow-up study. *Journal of sport science*, 22(4):347-55.

Garrido, N., Marinho, D.A., Barbosa, T.M., Costa, A.M., Silva, A.J., Pérez-Turpin, J.A., Marques, M.C. (2010). Relationships between dry land strength, power variables and short sprint performance in young competitive swimmers. *Journal of Human Sport & Exercise*, Vol V, No II, 240-249.

Malacko, J., Rađo, I. (2004). Tehnologija sporta i sportskog treninga. Univerzitetska knjiga, Fakultet sporta i tjelesnog odgoja, Univerzitet u Sarajevu, Sarajevo.

Metikoš, D., Milanović, D., Prot, F., Jukić, I., Marković, G. (2003). Teorijske i metodičke osnove razvoja koordinacije. U Milanović, D., Jukić, I. (ur). *Kondicijska priprema sportaša*, Zbornik radova međunarodnog znanstvenostručnog skupa, str. 264-270, Kineziološki fakultet Sveučilišta u Zagrebu; Udruga kondicijskih trenera Hrvatske.

Modrić, T., Veršić, Š., Popović, B. (2011). Specifična koordinacija u vaterpolu – neke metrijske karakteristike četiri novokonstruisana testa. 9 godišnja međunarodna konferencija *Kondicijska priprema sportaša*, Zagreb.

Sekulić, D., Metikoš, M. (2007). Osnove transformacijskih postupaka u kineziologiji. Split: Sveučilište u Splitu.

Šimenc, Z., Ris, B., Vuleta, D. (1990). Analiza utjecaja procesa treninga u plivačkoj i vaterpolskoj koli na razvoj nekih bazičnih motoričkih sposobnosti. Zbornik radova I. Međunarodnog simpozija „Šport mladih“, Ljubljana – Bled.

Trumbić I. (2010). Vaterpolo. Udžbenik, Samostalno izdanje.

Comparative analysis of foot status and certain motoric capabilities in female volleyball and handball players

Tamara Đurković¹, Dejan Ilić¹, Goran Nešić¹, Danica Janičijević¹, Nikola Fišeković¹

¹Faculty of Sport and Physical Education, University of Belgrade, Serbia

ABSTRACT

Aim of this research was to determine and compare status of motoric capabilities in female volleyball and handball players, and to show foot status in subjects as well. Three variables for assessment of anthropometric characteristics and eight variables for assessment of motoric capabilities were observed. By comparing the status of certain motoric capabilities, attempt was made to comprehend differences between them. In order to define specific motoric space of female volleyball and handball players, eight motoric tests were implemented, which covered the space of explosive strength, repetitive strength, flexibility, speed and speed of change of direction, agility. In order to determine the foot status, plantography was carried out. Based on the results obtained in the scope of anthropometric space, statistically significant difference was found in one variable, and those were the results of body height measurement. Statistically significant difference was found in two variables of the motoric space, those being modified Jelka test and 20 meters sprint. Of the total number of subjects, 23 have normal foot status, while 35 have disturbed foot status.

Key words: volleyball, handball, motoric capabilities, foot status

INTRODUCTION

Motoric capabilities are those capabilities of human beings that are involved in solving motoric tasks and that affect the successful movement, whether they are conditioned or not. (Kukolj, 2006) This term was given different names by various authors (anthropometric capabilities, biomotoric dimensions,

kinesiologic capabilities, movement habits, motoric dimensions, etc.), but they all talk about properties of man that express his physical preparedness for certain kind of work and creative expression of his or her personality as well. The term motoric capabilities, most frequently translated to term physical capabilities, appeared for the first time in the works of theorists of physical education, at the end o 19th and the beginning of 20th century. Aim of this research was to determine and compare level of motor capabilities in female handball and volleyball players 13 years of age, and to show their foot status as well. Analysing differences between these two groups, we can learn something more about particular sports, characteristics of girls of this age and at last, but not the least we can help them to correct postural disorders that has been found.

METHOD

Sample of subjects

Sample of subjects included 58 girls 13 years of age. Of the total number of subjects, 29 subjects play handball, and the other half of subjects plays volleyball.

Sample of variables

At first, testing of anthropometric characteristics was carried out, body weight(BW) and body height(BH), and foot plantography was conducted. After that, following motoric tests were carried out: standing long jump(SLJ), Sargent test(ST), modified Jelka test (MJT), 20 meters sprint (lap time at 10 meters), throwing 2kg medicine ball (MBT), bat flex test (BFT), deep forward bend on bench(DFB) and lying-sitting(LS) (lifitng the torso) in 20 seconds. Testing was carried out with the aim of comparing of motoric capabilities between the two groups and showing the foot status. In the table 1, and table 2 is also shown a highest reach of one hand (HROH) for both handball and volleyball players.

The method of tests implementation

During the time period between 7th of April, 2014. to 10th of April, 2014., the testing of anthropometric characteristics and motoric capabilities was carried out, and foot plantography was conducted. Testing was carried out in four different clubs, two volleyball clubs, VC Zeleznik and VC Roda, and two handball clubs, HC Voždovac and HC Radnički from Belgrade. The testings were distributed in such a way to avoid influence of one test on the other one. Before taking the test, subjects were given the detailed explanations of test protocol, followed by a practical presentation. Each subject had one trial,

after which two attempts were measured. Only the better result was taken into the statistical analysis. Between the attempts, depending on motoric test, adequate pause was given, and between the tests, 5 minute pause was given. For body height measurement, Martin's anthropometer was used, and for body weight measurement portable scale with 0,1kg precision was used. Regarding checking the foot status, plantography was conducted. Thomsen's method was used for interpreting the plantogram. The assessment of motoric capabilities was carried out using battery of tests.

RESULTS WITH DISCUSSION

In this section of this work, results of the measurement are presented regarding certain motoric capabilities in the subjects playing handball and volleyball. Comparative analysis is performed as well, in order to compare motoric capabilities of the two samples.

Results of the motoric capabilities of the female handball players.

Table 1. Presentation of descriptive analysis results of morphologic characteristics of female handball players

	N	Min	Max	Mean	SD	Skewness		Kurtosis		cV%
	Statistic	Statistic	Statistic	Statistic	Statistic	Statistic	Std. Error	Statistic	Std. Error	Statistic
BH-H	29	1,47	1,75	1,62	0,08	-0,20	0,43	-0,62	0,84	4,95
BW-H	29	37,8	78	54,05	9,26	0,46	0,43	0,23	0,84	17,14
BMI-H	29	16,36	27,31	20,47	2,52	1,03	0,43	1,54	0,84	12,34
SLJ-H	29	125	208	166,17	20,90	0,17	0,43	-0,34	0,84	12,57
HROH-H	29	189	231	209,37	10,08	-0,34	0,43	-0,04	0,84	4,81
ST-H	29	19	45	30,34	7,02	0,09	0,43	-0,89	0,84	23,13
MJT-H	29	10,85	15,19	12,73	1,22	0,59	0,43	-0,53	0,84	9,60
Sp(10m)-H	29	2,01	2,97	2,38	0,22	0,72	0,43	1,10	0,84	9,64
Sp(20m)-H	29	3,39	4,5	3,89	0,26	0,11	0,43	-0,23	0,84	6,85
MBT-H	29	410	1063	651,31	145,51	0,71	0,43	1,04	0,84	22,34
DFB-H	29	-10	19	5,34	6,68	-0,04	0,43	-0,19	0,84	125,13
BFT-H	29	50	113	79,65	17,36	0,19	0,43	-0,81	0,84	21,79
LS (20 s)-H	29	15	21	18,37	1,84	-0,23	0,43	-1,30	0,84	10,01
Valid N (listwise)	29									

Results of motoric capabilities of the female volleyball players

Table 2. Presentation of the descriptive statistics results of the morphologic characteristics and motoric capabilities of the female volleyball players.

	N	Min	Max	mean	SD	Skew.		Kurt.		cV%
	Statistic	Statistic	Statistic	Statistic	Statistic	Statistic	Std. Error	Statistic	Std. Error	Statistic
BH-V	29	1,56	1,75	1,67	0,04	-0,59	0,434	1,14	0,84	2,43
BW-V	29	48	63	56,62	3,68	-0,47	0,434	-0,27	0,84	6,51
BMI-V	29	18,21	21,71	20,23	0,81	-0,44	0,434	-0,01	0,84	4,00
SLJ-V	29	113	176	158,03	15,28	-1,21	0,434	1,24	0,84	9,67
HROH-V	29	197	229	211,72	7,49	0,15	0,434	-0,36	0,84	3,53
ST-V	29	17	38	28,55	5,61	-0,59	0,434	-0,44	0,84	19,67
MJT-V	29	12,46	17,42	14,69	1,23	0,40	0,434	-0,23	0,84	8,40
Sprint (10m)-V	29	2,12	3,03	2,36	0,19	1,45	0,434	3,29	0,84	8,30
Sprint (20m)-V	29	3,93	4,89	4,23	0,25	1,15	0,434	1,08	0,84	6,01
MBT-V	29	550	880	691,89	80,27	0,48	0,434	0,43	0,84	11,60
DFB-V	29	-3	13	6,24	4,59	-0,20	0,434	-0,86	0,84	73,62
BFT-V	29	45	103	73,27	14,18	0,12	0,434	-0,25	0,84	19,36
LS(20S)-V	29	15	21	17,65	1,75	0,14	0,434	-0,75	0,84	9,95
Valid N (listwise)	29									

Comparative analysis of motoric capabilities of the female handball and volleyball players

In this section, presentation of comparative analysis of the certain anthropometric parameters, and parameters of motoric space of the examined sample as well (Table 3). Univariant level of testing was implemented (T-test).

Table 3. Presentation of the comparative statistics results – T-test (female handball and volleyball players)

INVITED LECTURES
POZVANA PREDAVANJA

Test	Group	Paired Differences				t	df	Sig. (2-tailed)
		Mean Diff.	SD	95% Confidence Interval of the Difference				
				Lower	Upper			
BH	O:R	.05	.08	.02	.08	3.58	28	.001*
BW	O:R	2.57	8.88	-.81	5.94	1.56	28	.131
BMI	O:R	-.24	2.49	-1.18	.71	-.51	28	.614
HROH	O:R	2.34	12.15	-2.28	6.97	1.04	28	.308
ST	O:R	-1.79	7.16	-4.52	.93	-1.35	28	.188
SLJ	O:R	-8.14	22.58	-16.73	.45	-1.94	28	.062
MBT	O:R	40.59	162.48	-21.22	102.39	1.35	28	.189
LS20s	O:R	-.72	2.51	-1.68	.23	-1.56	28	.131
MJT	O:R	1.97	1.70	1.32	2.61	6.22	28	.000*
SP10m	O:R	-.02	.29	-.13	.10	-.28	28	.781
SP20m	O:R	.33	.38	.19	.48	4.74	28	.000*
DFB	O:R	.90	8.46	-2.32	4.11	.57	28	.573
BFT	O:R	-6.38	22.68	-15.01	2.25	-1.52	28	.141

Values of the T-test were obtained based on anthropometric and motoric parameters, measured in subjects that play handball and volleyball. Regarding anthropometric space, there is statistically significant difference at level $p=0,001$ in body height in favor of the volleyball players. Regarding motoric space, statistically significant difference is observable in Jelka test at the level of $p=0.00$ in favor of handball players and in 20m sprint test at the level of $p=0,00$ in favor of handball players.

In the case of other variables of anthropometric space (body weight and body mass index) as well as motoric space, no statistically significant difference was measured between these two samples. The assumption is that training itself at this age for both groups of subjects is similar, and, thus, there are no larger differences when it comes to their motoric capabilities.

Foot status analysis

For interpretation of plantogram, the Thomsen's method was used. Of the total number of handball players, 11 subjects have normal foot, while 18 have disturbed foot arch, and when it comes to volleyball players 12 subjects have normal foot, while 17 have disturbed foot arch.

CONCLUSION

Based on the presented results and their discussion, certain conclusion can be drawn:

1. There is statistically significant difference in terms of body height at the level of $p=0,001$, where it was measured that volleyball players have higher body height.

2. There is statistically significant difference in motoric capabilities in these two groups of subjects, in two of eight examined variables of motoric space, and those are in modified Jelka test and 20m sprint.

3. In 60,34% of the total number of subjects there is disturbed foot arch.

4. In the conducted research, observed statistically significant difference in body height can be attributed to good selection of subjects that play volleyball. When it comes to modified Jelka test, test that assesses speed of change of direction, agility, statistically significant difference was found explained by assumption that the subjects that play handball achieved better results due to the specific features of the sport itself. Statistically significant difference observed in 20 meters sprint test in favor of handball players can be explained by differences in dimensions of the playgrounds and specificity of the sport branches.

5. In other variables of the motoric space, no statistically significant differences were found between the two samples.

6. When it comes to the foot status, the aim of the research was to show only the current status, that is to show to what extent the foot status is disturbed. Of the total number of subjects, 23 subjects have normal foot, while 35 have disturbed the foot arch. When it comes to the group that plays the handball, 11 have normal foot, while 18 have disturbed foot arch.

7. In the case of the group that plays volleyball, 12 have normal foot, while 17 have disturbed foot arch.

8. Disturbance of the normal foot status, such as shown in this example, that is research, should be a warning for all the coaches, as well as professors of physical education. During the class itself, and training, carry out testings and set the exercises that will have preventive action on the entire body structure. In that way, the students and athletes will avoid deformities that later in life can cause much more serious consequences, injuries, above all. That's why the responsible and competent persons should be working with younger categories.

REFERENCES

- Бокан, М. (2009). Моторичке способности одбојкаша и тестова за њихову процену. Београд: Физичка култура. 63: стр.116-125
- Бошковић, М. (2005). Анатомија човека. Београд: Научна књига.
- Илић, Д. (2012). Корективна гимнастика. Практикум. Београд: Факултет спорта и физичког васпитања
- Janković, V., Marelić, N. (1995). *Odbojka*. Zagreb. Fakultet fizičke kulture.
- Котуровић, Љ. и Јеричевић, Д. (1988). Београд: Спортске игре: ГРО, Спортска игра
- Кукољ, М. (2006). Антропомоторика. Београд: Факултет спорта и физичког васпитања.
- Нешић, Г. (2002). Основи антропомоторике. Стандард 2. Београд: Спортска академија.
- Стојановић, Т., Костић, Р., Нешић, Г. (2005). Одбојка. Графид. Бања Лука: Факултет физичког васпитања и спорта.
- Угарковић, Д. (1996). Биологија развоја човека са основама спортске медицине. Београд: Факултет физичке културе.
- Зациорски, В. М. (1969). Физичка својства спортисте. Београд: Југословенски завод за физичку културу и медицину спорта.

Hijerarhijska klasifikacija metodičkog modela za poduku skijaškog plužnog zavoja i plužnog luka

Danijela Kuna¹, Sanjin Džajić², Josip Maleš¹

¹*Kineziološki fakultet, Sveučilište u Splitu, Hrvatska*

²*Srednja škola Konjic, Bosna i Hercegovina*

ABSTRACT

The purpose of this research was to establish the hierarchical classification of expert model on fundamental methodological exercises for teaching of the movement of snow plow turn and snow plow bow in ski school. Participants were 307 skiing experts of varying degrees of cross-education from different states. Defined expert model of the 6 most important methodical exercises to teach the snow plow turn and 5 most important methodical exercises to teach the snow plow bow, was ranked by the ski experts of different levels of education. Their rating was based on the importance of implementation in the methodology of teaching the novice skier. Using non-parametric analogue post-hoc analysis, i.e. Kruskal-Wallis test (H-test) and appropriate empiric level of significance (p), statistic significance of sums of ranks (ΣR) of the most important methodical exercises for teaching snow plow turn and snow plow bow have been tested. In ranking of the most important methodical exercises for teaching both skiing figure have been established a statistically significant difference at the level of $p < 0.001$. Reliability between the ski experts was examined using the Kendall Tau (τ) coefficient of concordance. Those variables which were not different in statistically significant way according to sums of rank were classified in one significant group, while variables which showed statistically significant difference were classified separately. Based on obtained significant differences in ranking importance methodical exercises for teaching snow plow turn and snow plow bow, and by the help of values of total rank sum, hierarchical classification among the differences had been successfully formed. This research makes a good basis for future works where skiing experts throughout the world should be engaged, and evaluation of hierarchical classification experts model of teaching snow plow turn and snow plow bow.

Key words: methodical exercises, snow plow turn, snow plow bow, ski experts

UVOD

Alpsko skijanje spada u red onih motoričkih aktivnosti tijekom koje skijaš služeći se različitim skijaškim tehnikama savladava strmine različitih nagiba. Evolucijskim razvojem skijaške opreme alpsko skijanje je preraslo u jednu od najpopularnijih oblika rekreativne aktivnosti i profesionalni sport. Veliki broj skijaških tehnika i opreme prilagođene svim dobnim i spolnim skupinama, boravak na oštrom planinskom zraku i u ugodnom društvu, skijanje kao sportsko-rekreativnu aktivnost čini čarobnom. Da bi uspješno savladali svoje prve skijaške korake velika većina skijaških početnika traži pomoć skijaških stručnjaka upisujući se u program škole skijanja (Lešnik i Žvan 2010.). Radi što kvalitetnijeg usvajanja, izvođenja i manjeg utroška količine energije, programi škole skijanja se neprestano razvijaju i unaprjeđuju. Polazna točka svih programa škole skijanja je omogućiti postupnost u učenju skijanja. Savladavanje skijaških elemenata i primjena specifičnih metodičkih vježbi za njihovu poduku treba biti u logičnom metodskom slijedu jer samo na takav način se olakšava i ubrzava proces usvajanja i savladavanja skijaških znanja. Budući je proces poduke alpskih skijaša iznimno složen proces ovisan o mnogobrojnim čimbenicima, a prije svega o antropološkim specifičnostima pojedinca, uvjetima na skijaškoj stazi i razini skijaškog predznanja skijaša, u praksi se velika pažnja posvećuje modelu po kojem će se skijaši poučavati (Kuna 2013.). Danas je rezultat toga primjena i implementacija različitih modela procesa poduke alpskih skijaša koji egzistiraju među različitim nacijama i programima škole skijanja. Osnova velike većine programa je da skijaš najprije savladava osnovne skijaške kretnje na ravnom terenu i elemente prilagodbe nakon čega usvaja plućnu, potom paralelnu, pa carving skijašku tehniku. Plućna i paralelna skijaška tehnika čine neizostavan dio metodike poduke alpskih skijaša jer omogućavaju da skijaš u pravom trenutku primjeni određenu razinu skijaškog znanja i da nadasve olakšaju daljnji tijek procesa usvajanja specifičnih znanja. Na taj način polaznik školeskijanja stječe nove skijaške kompetencije čime se njegov unutrašnji proces koji je ovisan o kapacitetu izvedbe svakog elementa, poboljšava vježbanjem te raste proporcionalno ukupnom skijaškom znanju i iskustvu, odnosno skijanju. Plućna skijaška tehnika spada pod elemente osnovne škole skijanja, a

idealna je za početnike svih uzrasta. Plužni položaj skija karakteriziraju široko razdvojeni zadnji dijelovi (repovi) skija, sa blago spojenim prednjim dijelovima (vrhovima) što početniku omogućuje stabilnost, kontrolu brzine a samim tim i sigurnost tijekom savladavanja blažih skijaških padina. Prema ekspertnom modelu usvajanja najvažnijih likova osnovne i napredne škole skijanja, plužni luk spada pod temeljne elemente osnovne škole skijanja (Kuna 2012.). Tehnika izvođenja plužnog zavoja skijašu početniku omogućava sigurno i kontrolirano spuštanje niz padinu, a podrazumijeva kontinuirani i istovremeni potisak oba koljena prema naprijed i unutra što dovodi skije u poziciju rubljenja, gdje je neophodno prethodno prebacivanje težine na buduću vanjsku skiju u odnosu na smjer kretanja. U usporedbi s plužnim zavojem, tehnika izvođenja plužnog luka objedinjuje plužni zavoj i spust koso kojeg skijaš izvodi tijekom prelaska iz jednog zavoja u drugi. Izvođenje plužnog luka započinje u srednjem skijaškom stavu u spustu koso na paralelno postavljenim skijama. Skijaš nakon spusta koso raspluženjem obiju skija i prijenosom težine na buduću donju skiju izvodi završeni plužni zavoj i spušta se u niži skijaški stav. Prolazeći padnom linijom skijaš izvodi postepeno priključenje gornje skije do ponovnog dolaska u srednji skijaški stav spusta koso nakon čega te iste kretne strukture ponavlja na drugu stranu. Plužni luk čini skijašku strukturu izvedbe pomoću koje skijaš može uspješno kontrolirati brzinu i smjer kretanja skija na blažim skijaškima stazama, pa prema ekspertnom mišljenju spada među najvažnije elemente osnovne škole skijanja (Kuna 2012.). Oslanjajući se na rezultate istraživanja u kojima je postavljen ekspertni model najvažnijih metodičkih vježbi za poduku plužnog zavoja i plužnog luka, elemenata osnovne škole skijanja (Kuna 2014. i 2015.), javila se ideja za daljnjim metodskim postavkama. U svezi s navedenim, proizašao je glavni cilj ovog istraživanja, a to je formiranje hijerarhijske klasifikacije ekspertnog modela metodičkih vježbi za poduku plužnog zavoja i plužnog luka.

METODE RADA

Radi prikaza ekspertnog modela najvažnijih metodičkih vježbi za poduku plužnog zavoja i plužnog luka, izrađeni su *gifovi* video isječaka snimljenih metodičkih vježbi. Potom je uslijedila instalacija online ankete na specijalizirani sustav, gdje je opisan protokol i cilj istraživanja. Popunjavanje upitnika

provedeno je elektronski (putem interneta), a ispitanici su osim autorice rada putem e-maila dobili poziv od strane predsjednika i članova izvršnog odbora ZUTS-a Slovenije, HZUTS-a Hrvatske i ATUS-a Bosne i Hercegovine koji su odobrili provedbu ovog istraživanja. Istraživanju se odazvalo 460 slovenskih, hrvatskih i bosansko-hercegovačkih skijaških učitelja i demonstratora skijanja različite razine stručnosti. Glavni kriterij izbora ispitanika čiji su se rezultati uzimali u obzir uvjetovala je u potpunosti ispunjena anketa s preciznom identifikacijom IP adrese i osobnim podacima. Djelomično ispunjene ankete, kao i rezultati onih anketa koje su ispunjene metodom istog sustava vrednovanja svih varijabli, nisu ulazile u obradu. Nakon pregledavanja varijabli identifikacije i klasifikacije ispitanika, koji su pristupili online ispunjavanju ankete, za daljnju obradu podataka odabrani su rezultati od 307 ispitanika. Od toga je bilo 119 slovenskih, 128 hrvatskih i 60 bosansko-hercegovačkih učitelja i demonstratora skijanja različite razine stručnosti u dobi između 25 - 45 godina. Uzorak varijabli najvažnijih metodičkih vježbi za poduku plućnog zavoja su činile vježbe: *NPRS (naizmjenično potiskivanje repovima skija)*, *AVPZ (imitacija aviona)*, *PŠK (potiskivanje šakama koljena)*, *OŠVK (obje šake na vanjsko koljeno)*, *PTPZ (ptić plućnog zavoja)*, *KORPZ (zadani smjer kretanja)*. Uzorak varijabli najvažnijih metodičkih vježbi za poduku plućnog luka su činile vježbe: *SPKGŠUP (spust koso gibanje gore - dolje s štapovima u predručenju)*, *SPKPK (spust koso, plućenje koso)*, *ŠIPNK (šake iz predručenja na koljena)*, *PTPL (ptić plućnog luka)*, *ŠTUPL (štapovi u predručenju)*. Zadatak ispitanika je bio da formirani ekspertni model metodičkih vježbi za poduku plućnog zavoja i plućnog luka rangiraju temeljem važnosti primjene pojedinih vježbi. Obrada podataka izvršila se pomoću programa STATISTICA Windows 12.0, a prag značajnosti postavljen je na $p < 0.001$. Izračunate su ukupne vrijednosti sume ranga (ΣR), Kruskal-Wallisov testa (H-test) i pripadnog empirijskog nivoa signifikantnosti (p) radi ispitivanja statističke značajnosti razlika između vrijednosti sume ranga najvažnijih metodičkih vježbi za poduku plućnog zavoja i plućnog luka. U svrhu utvrđivanja suglasnosti među skijaškim stručnjacima, izračunate su vrijednosti Kendall Tau (τ) koeficijenta konkordancije.

REZULTATI I RASPRAVA

U Tablici 1. prikazane su ukupne vrijednosti rangiranja najvažnijih metodičkih vježbi za poduku plućnog zavoja i plućnog luka od strane skijaških

stručnjaka različitog stupnja skijaške izobrazbe. Na osnovu iznesenih rezultata vidljiva je statistički značajna razlika u rangiranju metodičkih vježbi za poduku oba skijaška elementa. Vrijednosti Kruskal-Wallisovog testa (H-test) i statističke značajnosti (p) za pluzni zavoj su iznosile: $H=429,43$; $p<0,001$; dok su za pluzni luk bile: $H=60,77$; $p<0,001$.

U vrijednostima rangiranja metodičkih vježbi za poduku pluznog zavoja statistički značajna razlika za $p=0,00$, utvrđena je između vježbe *obje šake na vanjsko koljeno*, *imitacija aviona* i *imitacija ptice*, između vježbe *naizmjenično potiskivanje repovima skija*, *obje šake na vanjsko koljeno*, *imitacija aviona*, *potiskivanje šakama koljena* i *zadani smjer kretanja*. Nadalje, statistički značajna razlika utvrđena je između vježbe *imitacija aviona* i *potiskivanje šakama koljena*, *imitacija ptice* i *zadani smjer kretanja*, te između vježbe *imitacija ptice*, *potiskivanje šakama koljena* i *zadani smjer kretanja*. Temeljem dobivenih značajnosti razlika rangiranja važnosti u primjeni pojedinih metodičkih vježbi za poduku pluznog zavoja i na osnovu vrijednosti sume ranga, formirana je hijerarhijska klasifikacija. Najvažnija metodička vježba za poduku pluznog zavoja je *imitacija aviona*. Izvodi se bez upotrebe skijaških štapova na način da skijaš nakon pluzenja ravno s rukama u odručenju postepeno vrši opterećenje na buduću vanjsku skiju, te uz istovremene kružne pokrete obaju koljena, vanjsku ruku spušta prema vanjskom koljenu, a unutarnju podiže u odručenje. Nakon prolaska preko padne linije i završetka zavoja skijaš prebacuje tjelesnu težinu na unutarnju, buduću vanjsku skiju, te odručenjem obiju ruku u širini ramena isti zadatak ponavlja na drugu stranu. Druga metodička vježba po važnosti je *postavljanje obiju šaka na vanjsko koljeno* gdje skijaš iz pluzenja ravno s rukama u predručenju početkom prebacivanja centra težišta na buduću vanjsku skiju i promjenom smjera kretanja spušta obje ruke prema vanjskom koljenu, te prelaskom u novi zavoj obje ruke ponovno podiže u predručenje. Visoki rang vrijednosti ovog operatora se ogleda u tome što skijaš držeći ruke u predručenju u trenutku prelaska iz jednog zavoja u novi, uspostavlja bolji ravnotežni položaj, a prebacivanjem obaju ruku prema vanjskom koljenu efektivnije uspostavlja opterećenje na vanjskoj skiji. Na trećem mjestu su vježba *potiskivanje šakama koljena* i *zadani smjer kretanja*. *Potiskivanje šakama koljena* je metodička vježba pomoću koje se pluzni zavoji izvode na način da skijaš postavlja šake na koljena, te ih tijekom svih faza izvedbe zavoja potiskuje u smjeru kretanja. Kružni pokreti koljenima tijekom

izvedbe plućnih zavoja su ključan čimbenik o kojem ovisi brzina usvajanja i efikasnost izvođenja plućnog zavoja, što je vjerojatno glavni razlog visokoj vrijednosti vrednovanja ove vježbe. Nakon što skijaš uspješno savlada plućni zavoj u lijevu i desnu stranu slijedeći korak je povezivanje plućnih zavoja u nizu. Stoga skijaški stručnjaci najčešće postavljaju koridor kroz koji skijaš prema unaprijed definiranim uputama izvodi plućne zavoje. Skijanje kroz koridor skijaškim početnicima, a osobito djeci, predstavlja veliki izazov i zadovoljstvo, zbog čega je njihova motivacija i želja za daljnjim učenjem i napretkom sve veća. Na četvrtom mjestu je vježba *imitacija ptice* gdje skijaš iz plućenja ravno s rukama u odručenju početkom prebacivanja centra težišta na buduću vanjsku skiju i promjenom smjera kretanja spušta obje ruke prema vanjskim dijelovima pancericica, te prelaskom u novi zavoj obje ruke ponovno podiže prema gore u odručenje. Vježba se izvodi bez štapova, a njena posebna vrijednost se ogleda u tome što imitacijom ptica skijaš stječe osjećaj za pravovremeno gibanje gore - dolje, odnosno opterećenje i rasterećenje skija tijekom prelaska iz zavoj u zavoj. Zbog raširenih ruku postavljenih u odručenje, skijaš lakše uspostavlja i zadržava ravnotežni položaj i centar opterećenja na skijama. Na posljednjem petom mjestu je vježba *naizmjenično potiskivanje repovima skija*. Izvodi se na način da skijaš iz plućenja ravno naizmjenično prema van potiskuje zadnji dio – rep jedne, a potom druge skije. Skijaš na taj način razvija dobar osjećaj za istovremeno usklađivanje različitih pokreta nad skijama, kružne pokrete koljenima i kontrolu pravca kretanja.

Pregledom hijerarhijske klasifikacije ekspertnog modela metodičkih vježbi za poduku plućnog zavoja, uočava se kako primarnu važnost prema mišljenju skijaških stručnjaka različitog stupnja skijaške izobrazbe imaju metodičke vježbe pomoću kojih skijaš savladava izvedbu specifičnih skijaških gibanja koordinirano s pravovremenim prebacivanjem težišta tijela u pojedinim fazama izvedbe plućnih zavoja, što je od primarne važnosti kod efikasnog vođenja skija. Iza toga važnu ulogu u metodici poduke plućnog zavoja imaju vježbe kojima skijaš naglašenim radom koljena uvjetuje promjenu smjera kretanja. Kombinirajući primjenu prethodno navedenih metodičkih vježbi u poduci plućnog zavoja, skijaš uči voditi skije naglašenim skijaškim gibanjima i radom koljena, uspostavljajući pravovremeni skijaški položaj u odnosu na skije, padinu i smjer kretanja, što je od primarne važnosti za kontroliranu i uspješnu izvedbu plućnih zavoja.

Tablica 1. Suma ranga najvažnijih operatora za poduku plućnog zavoja i plućnog luka (ΣR), vrijednosti Kruskal-Wallisovog testa (H -test) i pripadni nivo signifikantnosti (p).

OPERATORI PLUŽNOG ZAVOJA						
	OŠNVK	NPRS	AVPZ	PŠK	PTPZ	ΣR
OŠNVK						1056
NPRS	0,00					498
AVPZ	0,00	0,00				1305
PŠK	1,00	0,00	0,00			992
PTPZ	0,00	0,00	0,00	0,00		735
KORIDOR	0,13	0,00	0,00	1,00	0,00	943
H=429,43; p<0,001						
OPERATORI PLUŽNOG LUKA						
	SPKGŠUP	SPK- PK	ŠIPNK	PTPL		ΣR
SPKGŠUP						623
SPKPK	0,02					732
ŠIPNK	0,00	0,00				868
PTPL	0,00	1,00	0,13			779
ŠTUPL	0,00	0,03	1,00	0,99		838
H=60,77; p<0,001						

U rangiranju metodičkih vježbi za poduku plućnog luka pomoću neparametrijske analogne post-hoc analize za $p=0,00$ utvrđena je statistički značajna razlika između rangiranja vježbe *spust koso gibanje gore - dolje štapovima u predručenju* i *spust koso, plućenje koso*, te šake iz predručenja na koljena, ptić plućnog luka i *štapovi u predručenju*. U rangiranju vježbe *spust koso, plućenje koso* i šake iz odručenja na koljena utvrđena je statistički značajna razlika za $p=0,00$, dok je u odnosu na vježbu *štapovi u predručenju* dobivena razlika za $p=0,03$. Temeljem prikazanih statistički značajnih razlika u rangiranju važnosti primjene pojedinih vježbi za poduku plućnog luka, a na osnovu vrijednosti sume ranga svake od njih, formirana je hijerarhijska klasifikacija. Prema mišljenju skijaških stručnjaka različitog stupnja skijaške izobrazbe metodičke vježbe koje imaju najveću važnost u poduci plućnog luka su šake iz predručenja na koljena i štapovi u predručenju. U izvedbi metodičke vježbe šake iz predručenja na koljeno, skijaš iz predručenja tijekom izvedbe

spusta koso u trenutku raspluženja spušta obje šake na buduće vanjsko koljeno prebacujući centar težišta na buduću vanjsku skiju, te izvodi pluzni zavoj. Postavljajući ruke u predručenje skijaš se fokusira na uspostavljanje skija u paralelni položaj u širini kukova, te ravnotežnog položaja i centralnog pritiska na skijama. U trenutku raspluženja postavlja obje ruke na buduće vanjsko koljeno radi efikasnijeg prebacivanja centra težišta tijela na buduću vanjsku skiju, čime pospješuje izvedbu pluznog zavoja i kružnih gibanja koljena. U izvedbi metodičke vježbe štapovi u predručenju skijaš pluzni luk izvodi s paralelno postavljenim štapovima ispred tijela u širini ramena. Primarna vrijednost ove metodičke vježbe očituje se u tome što skijaš držanjem štapova u predručenju lakše uspostavlja visoki, srednji, odnosno niski skijaški položaj na skijama, ovisno o pojedinoj fazi izvedbe skijaškog elementa, čime su manja odstupanja položaja gornjeg dijela tijela u odnosu na skije.

Na drugom mjestu hijerarhijske klasifikacije najvažnijih metodičkih vježbi za poduku pluznog luka su vježbe *ptić pluznog luka* i *spust koso - pluzenje koso*. U izvedbi metodičke vježbe *ptić pluznog luka* skijaš imitacijom ptice pluzni luk izvodi na način da tijekom spusta koso ruke drži u odručenju u širini ramena, nakon čega početkom pluznog zavoja i promjenom smjera kretanja, obje ruke postavlja na koljena, te završetkom pluznog zavoja ruke ponovo podiže u zrak u odručenje, te prelazi u spust koso. Izvedba pluznog luka pomoću ptića utječe na efikasniju izvedbu i usklađivanje potrebnih vertikalnih i kružnih skijaških gibanja. Zbog raširenih i slobodnih ruku, pretpostavka je da skijaš bolje uspostavlja ravnotežni položaj i središnji pritisak na skijama, a u trenutku spuštanja ruku na koljena pravovremeno potiskuje potkoljenice na prednji dio pancericke gurajući koljena u pravcu skretanja čime pospješuje kružna gibanja koljenima i efikasnost izvedbe pluznog zavoja. *Spust koso – pluzenje koso* je metodička vježba pomoću koje skijaš uči pravovremeno uskladiti izvedbu kombinacije spusta koso i pluzenja koso u koordinaciji s vertikalnim skijaškim gibanjima. Na taj način se stvaraju mnogo povoljnije pretpostavke za usvajanje pluznog luka u cjelini i skraćuje se vrijeme poduke zbog čega su ga eksperti vrednovali kao najvažniji operator. Na posljednjem mjestu hijerarhijske klasifikacije metodičkih vježbi za poduku pluznog luka je vježba *spust koso gibanje gore - dolje s štapovima u predručenju*. To je vježba koja je po svojim sastavnicama izvedbe potpuno jednaka prethodnoj samo se izvodi s paralelno postavljenim štapovima u predručenju radi uspostavljanja i lakšeg zadržavanja pravilnog skijaškog položaja. Radi ispitivanja suglasnosti među skijaškim stručnjacima tijekom rangiranja metodičkih vježbi za poduku pluznog zavoja

i plućnog luka, ispitanici su temeljem slučajnog odabira podijeljeni u 5 grupa, nakon čega su izračunate i dobivene vrijednosti Kendall Tau (τ) koeficijenta konkordancije koje su se kretale u granicama od 0.72 do 0.88, što ukazuje na prikladnu usklađenost među njima.

Generalnim osvrtom na formiranu hijerarhijsku klasifikaciju ekspertnog modela metodičkih vježbi za poduku plućnog luka, uočava se kako primarnu važnost prema mišljenju skijaških stručnjaka različitog stupnja skijaške izobrazbe imaju metodičke vježbe pomoću kojih skijaš najprije usvaja pravilno uspostaviti ravnotežni položaj na skijama, te potom uskladiti izvedbu specifičnih skijaških gibanja s pravovremenim prebacivanjem težišta tijela u pojedinim fazama izvedbe plućnog luka. Slijedom iza toga u metodici poduke plućnog luka važnu ulogu imaju metodičke vježbe koje u svojim izvedbama obuhvaćaju prethodno spomenute sastavnice usvajanja plućnog luka. Obzirom da ne postoje radovi slične tematike, niti znanstveno utemeljeni metodski postupci za poduku plućnog zavoja i plućnog luka, ovo istraživanje ima posebnu vrijednost u vidu formiranja bazičnih struktura metodskih postavki.

ZAKLJUČAK

Na osnovu rezultata rangiranja važnosti primjene ekspertnog modela temeljnih metodičkih vježbi za poduku plućnog zavoja i plućnog luka od strane 307 skijaških stručnjaka različitog stupnja skijaške izobrazbe i statistički značajne razlike među njima, formirana je hijerarhijska klasifikacija. Prema dobivenim rezultatima, može se zaključiti kako su se utvrđenom statistički značajnom razlikom u rangiranju važnosti primjene metodičkih vježbi za poduku plućnog zavoja odvojeno klasificirale vježbe pomoću kojih skijaš savladava izvedbu specifičnih skijaških gibanja koordinirano s pravovremenim prebacivanjem težišta tijela u pojedinim fazama izvedbe zavoja, a potom vježbe kojima skijaš naglašenim radom koljena uvjetuje promjenu smjera kretanja. Kod plućnog luka odvojeno su se klasificirale vježbe kojima skijaš uči kako pravilno uspostaviti ravnotežni položaj na skijama, te potom vježbe pomoću kojih uči uskladiti izvedbu specifičnih skijaških gibanja s pravovremenim prebacivanjem težišta tijela u pojedinim fazama izvedbe plućnog luka. Dobiveni rezultati ovog istraživanja svoju aplikativnu vrijednost očituju u tome što će brojnim skijaškim stručnjacima različitog stupnja skijaškog obrazovanja omogućiti precizne metode smjernice u svezi primjene najvažnijih metodičkih vježbi za poduku plućnog zavoja i plućnog luka.

LITERATURA

Blaž Lešnik & Milan Žvan (2010). A turn to move on – Alpine skiing – Slovenian way, Theory and methodology of alpine skiing; SZS – Združenje učiteljev in trenerjev smučanja.

Kuna Danijela (2012). Formiranje ekspertnog modela likova osnovne i napredne škole skijanja. *Proceedings Of The 3rd International Conference Contemporary Kinesiology*. Miletić Đurđica et all (Ur.). Split : Faculty Of Kinesiology University Of Split, Croatia. 145-153.

Kuna D., Jelaska I., Džajić S. (2014). Metodčki model za poduku plužnog zavoja. *VII. Međunarodna konferencija - "Sport i zdravlje"* Tuzla, Bosna and Hercegovina, 96-102.

Kuna Danijela (2015). Metodčki model za poduku plužnog luka. *Proceedings of the 24th Summer School of the Croatian kinesiology, Methodical organizational forms of work in the areas of education, sports, sports recreation and physical training*. Neljak, Boris (ed.). Zagreb: Croatian Kinesiology Association (*prihvaćeno za objavu*).

Efekti različitih modela treninga na rezultatsku uspješnost u alpskom skijanju

Mersad Čuljević¹, Danijela Kuna²

¹*Sveučilište u Sarajevu, Akademija Scenskih Umjetnosti, Bosna i Hercegovina*

²*Kineziološki fakultet, Sveučilište u Splitu, Hrvatska*

ABSTRACT

The goal of the research was to establish the impact of the innovative model of acrobatics training on the success of Alpine skiing (experimental program), and his comparison to the effect derived from the classical concept of conditional training of Alpine skiers. The average age of respondents was from nine to thirteen years, in the age groups of younger and older boys and girls. The total of fifty-three respondents participated in this research, from which there was twenty-seven respondents in the control group (nineteen boys and seven girls), and the experimental group counted total of twenty-three respondents (seventeen boys and seven girls). The experimental program was conducted during the preparatory competition period, between the two ski competition seasons. The experimental group was subject to programmed kinesiology treatment of innovative training models of acrobatics in duration of total of twenty-four weeks, three times a week for ninety minutes, while the control group had ski fitness trainings in the same proportion. For the purpose of testing the significance of differences in the progression of the experimental and control groups the author used two-way analysis of variance for dependent and independent samples. Analysis of the results showed a statistically significant interaction between the two types of training process and the period of time between the competitions ($F=13,346$, $p=,00063$, $\eta^2=0,21$), which represents a significant difference between the impact of the program. A statistically significant "small" difference between Experimental and Control groups in the initial measurement, and a statistically significant "big" difference in the final measurement was obtained ($F=20,92$, $p=0,00$, $\eta^2=0,30$). Based on the analysis of the results we can conclude that the

innovative model of acrobatics training has multiple significant usage value in the period of preparation before the competition, and integrated effect of the training process on the organism of young Alpine skiers.

Key words: innovative model of acrobatics training, experimental program, young Alpine skiers.

UVOD

Alpsko skijanje je aktivnost koja kao sport postavlja velike fizičke i psihičke napore pred skijaša, zahtijevajući od njega visoku razinu usvojenih specifičnih motoričkih znanja, izuzetnu agilnost, koordinaciju, snagu i izdržljivost koje su dokazano pozitivno povezane s uspjehom natjecatelja u alpskome skijanju (Bosco C. 1997; Reid i sur. 1997; Dolenc M. i Žvan M. 2001.). Odvija se u posebnim uvjetima vanjske sredine, a zbog evolucije razvoja skijaške opreme pred skijaše se postavljaju sve veći zahtjevi u fizičkoj pripremljenosti. Traže se nove, efikasnije, brže i sigurnije metode razvoja motoričkih sposobnosti i specifične kondicijske pripreme koje su direktno ili indirektno vezane uz ovaj sport. Glavna draž i specifičnost natjecateljskog skijanja je brzina kojoj teže svi skijaši. U natjecateljskom skijanju skijaš mora voziti tako da u najkraćem vremenu prođe određenu stazu i stigne do cilja, a da pri vožnji ne gubi brzinu. S obzirom na usvojeno znanje, natjecateljima je potrebno prilagođavati brzinu skijanja, jer je taj element tehnike alpskog skijanja kasnije veoma bitan. U radu s mladim natjecateljima, elemente tehnike treba prvo izvoditi pri malim brzinama, a tek kasnije povećavati brzinsku granicu. Ukoliko se zanemari postupnost u razvijanju brzine skijanja, dolazi do narušavanja motorike i tehnike skijanja, što utječe na rezultat natjecanja. Za mlade sportaše vrlo je važno da razviju cijeli niz temeljnih vještina koje će im pomoći da postanu općenito dobri sportaši prije nego počnu treniranje određenog sporta. To se naziva višestrani razvoj i jedno je od najvažnijih načela treninga djece i mladeži (Bompa 2005.). Upravo stoga se u kondicijskom treningu većine mladih sportaša razvijaju temeljne vještine kao što su trčanje, skakanje, hvatanje, bacanje, prevrtanje, ravnoteže. Na taj način djeca postaju izuzetno usklađena i usvajaju vještine koje su temeljne za uspješnost u različitim pojedinačnim i momčadskim sportovima kao što su sportska gimnastika, plivanje, laka atletika, košarka, nogomet. Razlog takvog pristupa leži u činjenici da niti jedna sportska grana ne osigurava cjelokupni razvoj djeteta. U tom pogledu nema bitne razlike ni kod djece koja se namjeravaju baviti skijanjem (Kostelić A. 2005.) Višestrani razvoj omogućiti će im da kasnije uspiju iskoristiti sva motorička znanja koja

su naučila i primjene ih tijekom skijanja. Bitnu ulogu u razvoju motoričkih sposobnosti, prije svega koordinacije, snage, fleksibilnosti i ravnoteže ima akrobatika koja čini segment sportske gimnastike. Akrobatski elementi imaju utjecaj na sposobnost kretanja tijela u prostoru, čime se pospješuje opća koordinacijska motorička sposobnost. Isto tako, preciznim te brzim radom i naizmjeničnom aktivacijom pojedinog mišića i mišićnih skupina, akrobatikom se razvijaju svi oblici snage, pri čemu je najznačajnija eksplozivna snaga donjih ekstremiteta (Živčić K. 2000.). Zbog navedenog, akrobatika je veoma raširena u svim sportskim granama i vrstama tjelesne aktivnosti. Svakako treba napomenuti da mnogi sportovi koriste akrobatske elemente kako bi se lakše savladale određene specifične motoričke kretnje (Neumayr i sur. 2003.). Nije rijedak slučaj da nogometaši nakon postignutog gola naprave seriju akrobatskih elemenata na travnatom terenu, a da ne govorimo o skakačima u vodu, hrvачima, džudašima, atletičarima, plesačima, tenisačima, skijašima i sportašima iz mnogih drugih sportova koji koriste akrobatiku kao sastavni dio trenažnog procesa. Budući neizostavan dio treninga mladih alpskih skijaša čine programi sportske gimnastike, odnosno akrobatike (Matković i sur. 1994; Andersen i sur. 2000; Krističević i sur. 2010.) proizašao je cilj ovog istraživanja, a to je: a) utvrditi efekte inovativnog modela treninga akrobatike na uspjeh u alpskom skijanju (eksperimentalni program) b) usporediti efekte eksperimentalnog programa sa efektima dobivenim klasičnim konceptom kondicijskog treninga.

METODE RADA

Uzorak ispitanika u ovom istraživanju predstavljala je grupa od 51 ispitanika ukupno. Činili su ih muški i ženski natjecatelji alpskog skijanja iz Sarajevskih skijaških klubova: Jahorina, Ilidža, Bjelašnica i Željezničar uzrasta od 10 do 13 godina. Ispitanici su podijeljeni na eksperimentalnu (N=27) i kontrolnu skupinu (N=24). Cjelokupno istraživanje je trajalo jednu godinu, a eksperimentalni program je proveden tijekom šest mjeseci u pripremnom natjecateljskom periodu, dakle između dvije natjecateljske skijaške sezone. Eksperimentalna skupina je bila podvrgnuta programiranom kineziološkom tretmanu inovativnog modela treninga akrobatike u trajanju od 24 tjedna, tri puta tjedno od 90 minuta. Inovativni model treninga akrobatike koncipiran je na način da su elementi koje su ispitanici učili i izvodili bili što više približeni strukturi natjecateljskog skijaškog položaja. Da bi se ispitanici adekvatno pripremili za učenje i izvođenje akrobatskih elemenata na početku svakog treninga radile su se vježbe zagrijavanja i razgibavanja u trajanju od 20 min.

Glavni dio treninga se izvodio u trajanju od 1h. Elementi akrobatike su se izvodili iz osnovnog skijaškog položaja i završavali u istom obliku. Model je osmišljen i strukturiran kroz četiri segmenta koja su se metodičkim slijedom, po složenosti strukture izvedbe primjenjivali, i to: 1) Program osnovnih akrobatskih elemenata bez faze leta: *Kolut naprijed jednonožnim odrazom bez korištenja ruku, Kolut naprijed običan grčeno, Kolut naprijed raznožno, Kolut unazad raznožno, Kolut naprijed sunožno ispruženim nogama, Kolut unazad do stava na šakama, Stav na šakama sunožnim odrazom grčeno, Stav na šakama sunožnim odrazom raznožno, Stav na šakama kolut naprijed, Premet strance (zvijezda), Premet strance sa pola okreta (rondat)*; 2) Program naprednih akrobatskih elemenata s fazom leta: *Leteći kolut, Sklopka s čela do usprava, Salto naprijed, Salto unazad*; 3) Program i prikaz akrobatskih elemenata, skokova na malom trampolinu: *Skok pruženi i zaustavljane, Skok prednožno zgrčeni, Skok prednožno-raznožni, Skok prednožno- sunožni, Skok pruženi s okretom oko uzdužne osi tijela, Salto naprijed grčeno*; 4) Program akrobatskih elemenata, skokova na velikom trampolinu: *Skok ravno pruženi, Skok prednožno grčeni, Skok prednožno raznožni, Skok u sjed sunožni, Skok na leđa grčeno, Skok s leđa s pola okreta do leđa, Skok letećim kolutom do leđa, Premet uporom naprijed, Premet uporom unazad, Salto pruženi unazad, Salto i pol unazad grčeni tijelom*. U završnom dijelu treninga su se radile vježbe istezanja i labavljenja u trajanju od 10 min.

Kontrolna skupina je u istom omjeru od 24 tjedna, tri puta tjedno od 90 minuta, imala skijaške kondicijske treninge čija struktura opterećenja je bila prilagođena individualnim mogućnostima pojedinih grupa ispitanika. Program vježbanja eksperimentalne grupe su činile vježbe za unapređenje agilnosti, koordinacije, snage i izdržljivosti. Nakon uvodno pripremnog dijela treninga kojeg su činile vježbe zagrijavanja i razgibavanja u trajanju od 30 minuta, u glavnom dijelu treninga u trajanju od 45 min primjenjivale su vježbe za unapređenje agilnosti, koordinacije, snage i izdržljivosti, i to: različiti oblici poligona prepreka 15-30 sec., trčanje četveronoške 10-15m., puzanje na prsima 5-10m., igre lovice trčeci i četveronoški 30 sec – 1min., različiti gimnastički elementi: kolut naprijed, nazad, zgrčka, zanoška, stoj na rukama, rondat, pregibi trupom 15-30 sec., sunožno preskakanje klupice 15-30 sec., zaklon iz ležanja na trbuhu 15-30 sec., preskakanje vijače 15-20 sec., sunožni poskoci sa zasucima trupa 10-15sec., vježbe ravnoteže otvorenim i zatvorenim očima (stajanje na niskoj gredi na obje noge poprečno, stajanje na niskoj gredi na obje noge uzduž grede, stajanje prednjim djelom stopala na niskoj gredi jednom nogom a druga je u odnoženju, prednoženju ili zanoženju) i vježbe dinamičke ravnoteže otvorenim i zatvorenim očima (prelaženje niske grede prvo hodanjem, trčanjem, sunožni i jednonožni poskoci, prelaženje prepreka

na niskoj gredi, hodanje i trčanje na gredi naprijed i nazad i trčanje naprijed sa okretima za 180°. Glavni dio treninga je koncipiran kružnom metodom rada. U završnom dijelu treninga radile su se vježbe istezanja i labavljenja u trajanju od 15 min. Pri pravljenu plana skijaškog treninga za vrijeme natjecateljske sezone kod obje skupine ispitanika vodilo se računa o tome da raspored treninga za obje grupe bude usklađen sa kalendarom natjecanja koja su se održavala vikendima subotom ili nedjeljom. Skijaški treninzi su se odvijali pet puta tjedno u trajanju od 180 minuta dok su subotom ili nedjeljom bila predviđena natjecanja. Sadržaji skijaških treninga je obuhvaćao: Rad na tehnici skijanja 30% treninga; vožnja između vrata veleslalom 40% i slalom 30% treninga, efektivni intenzitet treninga 120min, ukupni ekstenzitet treninga 240 sati, broj prijeđenih vrata 30720, broj prijeđenih vožnji 960, broj dana treninga 80 dana. Uzorak varijabli su činili ostvareni bodovi u dvije natjecateljske skijaške sezone u BiH za obje skupine ispitanika u disciplinama slalom i veleslalom, a na osnovu zvaničnih rang lista Skijaškog saveza BiH. Normalitet distribucije mjernih instrumenata utvrđen je prema rezultatu Kolmogorov-Smirnovljevog testa gdje su ostvareni bodovi ispitanika u dvije natjecateljske sezone imali normalnu distribuciju rezultata ($p > 0,20$). Podaci su analizirani programom STATISTICA Windows 12.0, a prag značajnosti postavljen je na $p < 0,05$. U svrhu testiranja značajnosti razlika u napredovanju eksperimentalne i kontrolne skupine korištena je dvosmjerna analiza varijance za zavisne i nezavisne uzorke.

REZULTATI I RASPRAVA

Grafički prikaz 1. Veličina interakcije između primijenjenog E i K programa rada i efekata trenažnog procesa

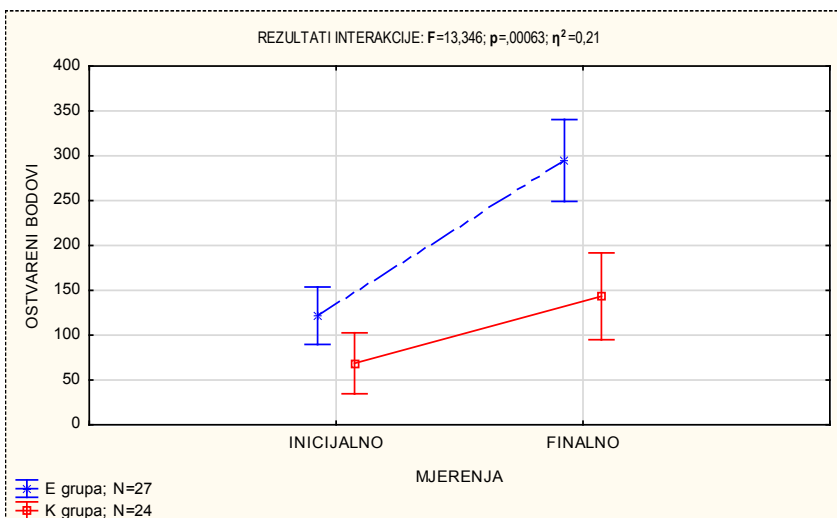

Prema *Grafičkom prikazu 1.*, za aritmetičke sredine E i K skupine ispitanika u ostvarenim skijaškim bodovima tijekom dvije natjecateljske sezone utvrđena je statistički značajna interakcija između dvije vrste trenažnog procesa i vremenskog perioda natjecanja ($F=13,346$, $p=,00063$, $\eta^2=0,21$), što predstavlja veliku razliku između učinka programa „high effect“ (Levin e & Hullett, 2002.). Na osnovu dobivenih rezultata može se konstatirati kako primijenjeni model inovativnog treninga akrobatike i skijaškog kondicijskog treninga u pripremnom natjecateljskom periodu u odnosu na skijaške natjecateljske treninge u natjecateljskom periodu, imaju različit razvojni učinak na skijašku uspješnost mladih alpskih skijaša. Nadalje, testiranjem statističke značajnosti razlike između E i K skupine u inicijalnom i finalnom mjerenju utvrđena je statistički značajna razlika. Prije provedbe eksperimentalnog programa rada, u inicijalnom mjerenju, statistička značajnost razlike između E i K skupine iznosila je: $F=5,23$, $p=0,003$, $\eta^2=0,10$ što predstavlja malu razliku između skupina „small effect“ (Levin e & Hullett, 2002.). Nakon provedbe eksperimentalnog programa rada, u finalnom mjerenju, statistička značajnost interakcije između E i K skupine je iznosila: $F=20,92$, $p=0,00$, $\eta^2=0,30$ što predstavlja veliku razliku između skupina „high effect“ (Levin e & Hullett, 2002.). Temeljem prethodno navedenih rezultata, može se konstatirati kako je pored skijaškog natjecateljskog treninga, inovativni model treninga akrobatike u odnosu na klasični kondicijski trening mladih natjecatelja alpskog skijanja utjecao na veći pozitivni efekt u ostvarenju ukupnog broja skijaških bodova u disciplinama veleslalom i slalom na kraju natjecateljske sezone. Kao što je već navedeno, akrobatski elementi koje je eksperimentalna skupina usvajala tijekom eksperimentalnog programa rada izvodili su se iz osnovnog skijaškog položaja, te su se u istom završavali. Izvršnost njihove izvedbe definirana je integracijom velikog broja visoko razvijenih motoričkih sposobnosti. U prvom redu akrobatski elementi značajno utječu na sposobnost kretanja tijela u prostoru, čime se pospješuje opća koordinacija, ravnoteža i fleksibilnost. Preciznim, brzim i naizmjeničnom radom i aktivacijom pojedinog mišića i mišićnih skupina, razvijaju se svi oblici snage, a najviše snaga ruku i ramenog pojasa, statička snaga trupa, te eksplozivna snagu nogu (Živčić K. 2007.). Stoga je točna i precizna izvedba specifičnih elemenata koji su se koristili u inovativnom programu akrobatike uvjetovana visokom međusobnom usklađenosti među pojedinim dijelovima tijela. Slične zakonitosti vrijede i u natjecateljskom alpskom skijanju. Naime, za vrijeme izvedbe specifične skijaške tehnike, skijaš, skije i štapovi čine jedinstven sustav koji optimalno funkcionira kada postoji visoka međusobna

usklađenost među pojedinim dijelovima sistema. Zbog navedenih činjenica od skijaša se zahtijeva izrazita situacijska učinkovitost. Skijaševa percepcija mora biti iznimno kvalitetna kao i procesiranje i izrada programa kretanja, jer se staza mora svladati brzo i precizno, a za to je naravno potrebna kvaliteta, što je slučaj i s natjecateljskom izvedbom (Maleš i sur., 2009.). Sve kretnje u cijelom kinetičkom lancu moraju biti koordinirane, a skijaš mora djelovati brzo bez narušavanja ravnotežnog položaja i gubitka brzine nad skijama. Stoga kondicijska priprema mladih alpskih skijaša pomoću inovativnog modela treninga akrobatike nije ništa drugo nego integrativni pristup koji predstavlja višu i učinkovitiju razinu modeliranja treninga od klasičnog koncepta kondicijske pripreme koji je u ovom istraživanju primijenjen. Pored toga, dobivenim rezultatima i pozitivnim promjenama u ostvarenju skijaških bodova kod obje skupine ispitanika zasigurno je doprinijelo usavršavanje skijaških natjecateljskih tehnika tijekom natjecateljskog perioda. Međutim budući su se ispitanici statistički značajno razlikovali u inicijalnom mjerenju, može se konstatirati kako je razina njihovih usvojenih skijaških znanja na različitim razinama. Pretpostavlja se kako je razina usvojenosti skijaških znanja i izvedba u situacijskim uvjetima kontrolne skupine ispitanika odraz stanja u kojemu se određene strukture gibanja pravilno izvode ali postoje izvjesna odstupanja od idealnih trajektorija. Zbog toga se specifična skijaška znanja očitovana tijekom izvođenja skijaških tehnika ne mogu u potpunosti upotrijebiti kao sadržaji vježbanja za razvoj osobina i sposobnosti koje su u njihovoj osnovi. Razina usvojenosti skijaških znanja i izvedba u situacijskim uvjetima eksperimentalne skupine ispitanika zasigurno je karakterizirana sa znatno manjim odstupanjima od idealnih trajektorija gibanja ili su beznačajna i mogu se pripisati pojedinačnom stilu izvođenja neke strukture kretanja. Na ovoj razini gibanje se izvodi automatski na dati skup nadražaja, s maksimalnim iskorištenjem svih trenutnih potencijala. Dakle, stupanj realizacije stečenih motoričkih znanja eksperimentalne i kontrolne skupine ispitanika je na različitim razinama i značajno se razlikovao u inicijalnom, a osobito u finalnom mjerenju. Shodno tome kontrolna skupina ispitanika nije bila u mogućnosti da optimalno eksploatira svoje antropološke potencijale, za razliku od eksperimentalne skupine ispitanika. Osim specifičnih skijaških znanja, pretpostavlja se kako je stupanj razvoja njihovih motoričkih sposobnosti o kojima ovisi učinkovitost skijaške izvedbe na različitoj razini. Ipak, prethodno navedene konstatacije bi trebalo potkrijepiti dodatnim istraživanjima i ispitivanjima razine usvojenosti specifičnih skijaških znanja i dijelovima antropološkog statusa obaju skupina ispitanika.

ZAKLJUČAK

Analiza rezultata ovog istraživanja pokazala je veliku razliku statistički značajne razlike između učinka inovativnog modela treninga akrobatike i klasičnog kondicijskog treninga skijaša u pripremnom natjecateljskom periodu, te skijaških natjecateljskih treninga u natjecateljskom periodu, na razvojni učinak skijaške uspješnosti mladih alpskih skijaša. Dobiveni rezultati ukazuju kako je Eksperimentalna skupina ispitanika koja je u pred natjecateljskom periodu usvajala akrobatske elemente značajno *više* poboljšala svoje rezultate, odnosno postigla bolji bodovni plasman na kraju skijaške natjecateljske sezone, u odnosu na eksperimentalnu skupinu ispitanika kod koje je ta promjena bila statistički značajno *manja*. Dobiveni rezultati upućuju na zaključak kako inovativni model treninga akrobatike ima višestruko veću značajnu uporabnu vrijednost u pred natjecateljskom periodu priprema, te integrirani učinak trenažnog postupka na organizam mladih alpskih skijaša. Daljnja istraživanja bi se trebala fokusirati na praćenje transformacijskih efekata i učinka tretmana modificiranog treninga akrobatike uz istovremeno praćenje stupnja usvojenosti specifičnih skijaških znanja.

LITERATURA

Andersen R. E., Montgomery D. L., Turcotte R.A. (1990.). An onsite test battery to evaluate giant slalom skiing performance. *Sports Med Phys Fitness*; 30 (3): 276-82.

Andersen RE, Montgomery DL., Bompa, T., O. (2005). Cjelokupan trening za mlade pobjednike. Zagreb: GOPAL.

Bosco, C. (1997). Evaluation and planning condition training for alpine skiers. U: *Science and skiing*, (ur. E. Muller, H. Schwameder, E. Kornexl, C. Raschner), str.229-250. London: E&FN Spoon.

Cigrovski, V., Matković, B. (2003). Specifična kondicijska priprema skijaša. U: *Zbornik radova Kondicijska priprema sportaša*, Zagreb, 21-22.02.2003. str. 518-520.

Dolenec M, Žvan M. (2001). Competitive success of junior female alpine skiers in light of certain chosen tests of co-ordination. *Kinesiologia Slovenica*; 7(1-2): str. 19-22.

Klika, R.J., Malina, R.M. (1997). Predicting skiing performance in 14-18 year old competitive alpine skiers. U: *Science and skiing*. (ur. E. Muller, H. Schwameder, E. Kornexl, C. Raschner), str. 273-284. London: E&FN Spoon.

Kostelić, A. (2005). Prikaz i analiza kondicijske pripreme Ivce i Janice Kostelić tijekom sportske karijere (razvoj i rezultati). (Diplomski rad). Zagreb: Kineziološki fakultet Sveučilišta u Zagrebu.

Maleš, B., Čavar, M., Franjko, I. (2009). Integracija razvoja znanja i kondicijske pripreme – temelj uspjeha u alpskom skijanju. /on line/. S mreže skinuto 20.11.2009.

http://www.skicentar.net/index.php?option=com_content&task=view&id=193&Itemid=57

Matković BR, Matković B., Ivanek M. (1994). Physiological characteristics of prospective alpine skiers. *CollAntropol*; 18(Suppl): 51-7.

Neumayr, G., Hoertnagl, H., Pfister, R., Koller, A., Eibl, G., Raas, E. (2003). Physical and Physiological Factors Associated with Success in Professional Alpine Skiing. *International Journal of Sports Medicine*, 24(8), 571-575.

Reid, R.C., Johnson, S.C., Kipp, R.W., Albert, R.W., White, A.T. (1997). Validity of sport-specific field tests for elite and developing alpine ski racers. U: *Science and skiing*. (ur. E. Muller, H. Schwameder, E. Kornexl, C. Raschner), str. 285-296. London: E&FN Spon.

Živčić K. (2000.). Biomehaničko vrednovanje vježbi za izvedbu premeta naprijed. (Doktorska disertacija). Zagreb: Kineziološki fakultet Sveučilišta u Zagrebu.

Živčić K. (2007.). Akrobatska abeceda u sportskoj gimnastici. Zagreb: Kineziološki Fakultet. Sveučilište u Zagrebu,.

Uticaj vežbi snage uz proteinsku suplementaciju na telesni sastav

Mila Vukadinović, Milan Pantović, Jelena Obradović

Faculty of Sport and Physical Education, Novi Sad, Serbia

ABSTRACT

The aim of this study was to determine the effects of 12 week resistance training with the consumption of protein supplementation on body composition (body mass, fat free mass, fat mass and muscle mass) in adolescents. Ten healthy male athletes aged 22 years \pm 6 months were randomly divided into two equal groups. The first group consisted of 5 subjects who consumed the proteins with resistance training (VP) and the second group consisted of 5 respondents who practiced resistance training without consuming additional protein supplementation (K). Resistance training was practiced for 12 weeks, four times a week. The intensity of the load was sub-maximal 80-95% 1RM. The measurement was carried out at 2 time points on bioimpedance MALTRON 920. The difference between the groups was determined by multivariate analysis of variance / univariate analysis of variance, and differences within the group was tested by t-test for paired samples. The results show that there is a significant difference between VP and K groups in fat-free mass, body fat and muscle mass ($p < .05$) whereas for body mass no significant difference between the groups was observed. The conclusion is that after 12 weeks of resistance training with men consuming protein athletes achieve better results in body composition than men which only practiced resistance training without additional protein supplementation.

Ključne reči: proteins, weight training, adolescents.

UVOD

Sportisti imaju dva puta veću potrebu za unos proteina nego ljudi koji se ne bave nikakvom fizičkom aktivnošću (Lemon, Tarnopolsky, MacDougal, i Atkinson, 1992) zbog bezmasne mase (BEZM) za čije je održavanje potrebno

više proteina, protenurije, sagorevanja malih količina proteina za vreme fizičke aktivnosti (5% od ukupnog sagorevanja energije) adaptacije mišićnih vlakana koja su bila oštećena tokom trajanja treninga sa opterećenjem (Butterfield, Cady, i Moynihan, 1992). Izvori proteina sa većom koncentracijom razgranatih lanaca (EAA) i drugih esencijalnih amino kiselina su višeg kvaliteta i efikasniji su u podsticanju sinteze proteina (Kerksick i sar., 2006). Vej protein sadrži veće količine svih potrebnih aminokiselina u odnosu na druge uobičajne izvore proteina koji se nalaze u hrani (Di Pasquale, 1999) a konzumiranjem pre i odmah posle vežbanja povećava se sinteza proteina u mišićima, a slabi razgradnja (Burd, Tang, Moore, i Phillips, 2006). Kod adolescenata mišićna masa (MM) se više povećava konzumiranjem proteinske suplementacije (vej protein i soja) uz treninga sa opterećenjem (9 nedelja) nego samostalan trening sa opterećenjem (Candow, Burke, Smith-Palmer, i Burke, 2006). Slične rezultate dobili su Brown, DiSilvestro, Babaknia, i Devor (2004). Autori smatraju da ne postoji nikakav napredak u MM kod ispitanika koji nisu konzumirali proteinsku suplementaciju (Brown i sar., 2004). Kod masne mase (MASM) i bezmasne mase (BEZM) Hoffman i sar. (2009) navode da ne postoji značajna razlika između sportista koji treniraju svakodnevno trening sa opterećenjem uz konzumiranje proteinske suplementacije (42 g enzimskog hidolizovanog kolagen protein izolata, vej protein izolat i kazein protein) ujutru i uveče, i onih koji konzumiraju pre i odmah posle treninga. Međutim, autori ipak navode da proteinska suplementacija (vej protein) uz trening sa opterećenjem ostvaruje pozitivne efekte na BEZM u poređenju sa placebo grupom kod mladih i starih ispitanika (Cermak, Res, De Groot, Saris, i Lon, 2012). BEZM posle 10 nedelja kod netreniranih muškaraca uzrasta 19 godina povećava se za $5,62 \pm 0,98$ kg ispitanici su unosili 40g proteina uz trening sa opterećenjem (Willoughby, Stout, i Wilborn, 2006). Kod gojaznih ispitanika koji su samo konzumirali vej protein 23 nedelje bez treninga sa opterećenjem telesna masa (TM) se smanjila za 1,8 kg (Baer i sar., 2011). Na osnovu svega navedenog, može se postaviti hipoteza da proteinska suplementacija uz treninga sa opterećenjem ostvaruje drugačije efekte na telesnu masu, masnu masu, bezmasnu masu i mišićnu masu od treninga sa opterećenjem bez proteinske suplementacije kod muškaraca. Primarni cilj rada bio je da se ispita da li postoji razlika u telesnom sastavu između grupa (VP grupa – ispitanici su pili proteinsku suplementaciju uz trening sa opterećenjem i K grupa- ispitanici su upražnjavali trening sa opterećenjem). Sekundarni cilj bio je da se pojedinačno ispituju grupe i utvrde efekti na telesni sastav.

METOD

Uzorak ispitanika

Deset muškaraca studenata Fakulteta sporta i fizičkog vaspitanja u Novom Sadu (godine 22 ± 6 meseci; telesna visina 181.94 ± 3.98 ; telesna masa 78.92 ± 6.58) potpisali su saglasnost za učestvovanje u istraživanju, a sve procedure u skladu su sa Helsinškom Deklaracijom (WMA, 2002). Randomizacijom podeljeni su u dve grupe po 5 ispitanika. Ispitanici u prvoj grupi ($n=5$) konzumirali su 1g/kg Twinlab Fuel 100% whey protein uz trening sa opterećenjem (VP) a ispitanici u drugoj grupi ($n=5$) trenirali su bez dodatne proteinske suplementacije (K).

Uzorak varijabli

Uz pomoć bioelektrične impedance MALTRON 920 (*bioimpedanca Maltron Bioscan 920 – 2*) dobijene su sledeće varijable: TM (kg) - telesna masa, BEZM (kg) – udeo bezmasne mase u telesnom sastavu, a predstavlja ukupnu masu mišićnog, vezivnog i koštanog tkiva, MASM (kg) - udeo masne mase u telesnom sastavu, MM (kg) – predstavlja udeo mišićne mase u telesnom sastavu.

Suplementacija

Ispitanici u grupi VP konzumirali su odmah posle vežbanja 1g/kg Twinlab Fuel 100% whey protein. Jedna merica od 35g (140kcal) sadrži - 25 g proteina surutke (vej izolat i vej koncentrat), 2 g masti, 5 g ugljenih hidrata, 3g BCAA (L-alanin 1290mg, L-arginin 600mg, L-asparaginska 3320mg, Cistein 730mg, Glutaminska kiselina 4460mg, Glicin 460mg, L-histidin 470mg, L-isoleucin 1620mg, L-leucin 2660mg, L-lysin 2190mg, L-metionin 620mg, L-fenilalanin 840mg, L-prolin 1660mg, L-serin 1290mg, L-treonin 1810mg, L-tiptofan 560mg, L-tirozin 770mg, L-valin 1480mg).

Protokol treninga sa opterećenjem

Eksperimentalni program trajao je 12 nedelja, 4 puta nedeljno. Svi ispitanici pratili su isti trenažni program. Radilo se metodom ponavljajućeg naprezanja (submaksimalno opterećenje do otkaza) (Zaciorski i Kremer, 2009). Repetativni maksimum (1RM) utvrđen je pre početka programa. Tri trenažna dana sastojala su se od različitih programa sa po 10 vežbi, koje se izvode u 3-5 serija (Tabela

br. 2). Posle trećeg trenažnog dana ispitanici su upražnjavali prvi pa drugi itd.. Kvalifikovano osoblje prisustvovalo je treninzima i pratilo rad ispitanika.

Tabela br. 1 Eksperimentalni program

Prvi trening – GRUDI – 1 osnovna vežba 5 serija 2 dodatne vežbe 3 serije	BICEPS – 1 osnovna vežba 5 serija 1 dodatna vežba 3 serije
Drugi trening - LEĐA – 1 osnovna vežba 5 serija 2 dodatne vežbe 3 serije	TRICEPS – 1 osnovna vežba 5 serija 2 dodatne vežbe 3 serije
Treći trening - RAMENA – 1 osnovna vežba 5 serija 2 dodatne vežbe 3 serije	NOGE – 1 osnovna vežba 5 serija 2 dodatne vežbe 3 serije

Merenje Telesnog sastava

Za procenjivanje telesnog sastava korišćena je bioelektrična impedanca MALTRON 920 (*bioimpedanca Maltron Bioscan 920 – 2*) u pre podnevnim časovima. Procenjivanjem telesnog sastava dobijeni su podaci u sledećim pokazateljima: telesna masa, udeo bezmasne mase u telesnom sastavu, a predstavlja ukupnu masu mišićnog, vezivnog i koštanog tkiva, udeo masne mase u telesnom sastavu i udeo mišićne mase u telesnom sastavu.

Metode obrade podataka

Za svaku varijablu izračunate su vrednosti aritmetičke sredine (AS), standardne devijacije (SD). Za utvrđivanje razlike između AS unutar grupe korišćen je t – test za zavisne uzorke. Za dobijanje razlike između ispitanika VP i K grupe bila je upotrebljena multiravijatna analiza varijanse i univarijatna analiza varijanse u statističkim programu SPSS 18.0.

REZULTATI

Unos hranjivih sastojaka tokom eksperimentalnog programa u trajanju od 12 nedelja bio je kontrolisan. U tabeli br.2 može se uočiti da ne postoji značajna razlika između grupa (VP i K) u procentualnoj zastupljenosti unosa proteina, masti i ugljenih hidrata u ishrani.

Tabela br. 2 Deskriptivna statistika i razlika između grupa u unosu hranjivih sastojak

Varijable		AS	SD	F	p
Proteini%	VP	24.70	5.03	1.15	.31
	K	21.26	3.73		
Masti%	VP	57.75	9.58	0.93	.36
	K	63.17	8.08		
Ugljenihidrat% ^o	VP	17.89	5.13	0.53	.48
	K	15.55	5.04		

Legenda: VP- veji protein grupa; K- kontrolna grupa; AS-aritmetička sredina; SD-standardna devijacija; F vrednost univarijatne analize varijanse; ; p – statistička značajnost univarijatne analize varijanse (< .05)*

Analizom tabele br. 3 kod VP grupe može se uočiti da postoji statistički značajna razlika između inicijalnog finalnog merenja u TM, BEZM, MASM i MM ($p < .05$)*. Aritmetičke sredine (AS) kod TM, MM i BEZM povećale su se kod VP grupe, dok se MASM smanjila. Kod K grupe u tabeli br. 3 može se zapaziti da ne postoji značajna razlika između ispitanika na inicijalnom i finalnom merenju u TM, BEZM i MASM ($p > .05$) jedino se u MM može se uočiti razlika značajna razlika ($p < .05$)*.

Tabela br. 3 Deskriptivna statistika i značajnost t-testa kod VP i K grupa

Varijable		VP (N=5)				K (N=5)			
		AS1	SD1	t	p	AS2	SD2	t	p
TM (kg)	IN	75.30	3.21	-6.07	.00*	77.98	5.26	-1.89	.13
	FIN	77.12	3.51			79.22	4.18		
BEZM (kg)	IN	67.86	1.62	-3.24	.03*	67.49	2.31	1.40	.23
	FIN	69.44	1.04			66.98	1.90		
MASM (kg)	IN	8.48	.60	4.22	.01*	8.74	.49	.80	.46
	FIN	6.99	.27			8.47	.66		
MM (kg)	IN	34.51	1.02	-8.32	.00*	33.54	1.43	-2.36	.05*
	FIN	36.16	.89			33.59	1.46		

Legenda: IN – inicijalno merenje; FIN – finalno merenje; AS1 – aritmetička sredina VP grupe; SD1 – standardna devijacija VP grupe; t- vrednost t-testa; p – statistička značajnost t-testa ($p < .05$)*; AS2- aritmetička sredina K grupe; SD2 – standardna devijacija K grupe.

Interpretacijom tabele br. 4 može se uočiti da u celokupnom sistemu analiziranih varijabli postoji statistički značajna razlika između grupa (VP i K) na finalnom merenju ($p = .00$)*. Pojedinačno analizirajući svaku varijablu na finalnom merenju može se uočiti da u TM ne postoji značajna razlika između grupa ($p > .05$) dok se kod BEZM, MASM i MM može uočiti značajna razlika ($p < .05$)*.

Tabela br. 4 Razlika između VP i K grupe na finalnom merenju u varijablama telesnog sastava

varijable	F	p
TM (kg) FIN	0.73	.41
BEZM (kg) FIN	6.40	.03*
MASM (kg) FIN	21.03	.00*
MIŠM (kg) FIN	11.24	.01*

F = 17.79; P = .00*

Legenda: f – F vrednost univarijatne analize varijanse; p – statistička značajnost univarijatne analize varijanse ($p < .05$)*; F – F vrednost multivarijatne analize varijanse; P – statistička značajnost multivarijatne analize varijanse ($p < .05$)*.

DISKUSIJA I ZAKLJUČAK

Rezultati pokazuju da su statistički značajne promene ostvarene kod VP grupe u MASM, BAZM, MM i TM ($p < .05$) dok se kod K grupe statistički značajne promene uočavaju samo u MM ($p < .05$). Metoda submaksimalnog opterećenja do otkaza uz unos 1g/kg vejj proteina (odmah posle treninga sa opterećenjem) povećava MM za 4,7%. Identične rezultate dobili su Canodow i sar. (2006) ali su njihov uzorak činili netrenirani muškarci uzrasta 18-35 godina, dok Joy i sar. (2013) navode da se MM povećala za 3,2kg kod treniranih ispitanika koji su konzumirali vejj protien uz 8 nedelja treninga sa opterećenjem. Kod K grupe može se uočiti da se MM povećala samo za 2,1%. Poznato je, da trening sa opterećenjem izaziva povećanje sinteze i razgradnje proteina (Tipton i sar., 1999). Međutim, unos aminokiselina odmah posle vežbanja povećava sintezu, a slabi razgradnju proteina u mišićima (Wolfe, 2001). Na osnovu dobijenih rezultata (VP=4,7%; K=2,1%) i navedenih činjenica može se pretpostaviti, da unos proteina (vejj) odmah posle treninga sa opterećenjem povećava MM više nego sam trening sa opterećenjem. Kod ispitanika koji nisu trenirali i nisu konzumirali proteinsku suplementaciju Brown i sar. (2004) navode da se ne ostvaruje napredak u MM. TM se kod VP grupe značajno povećala za 2,4%, dok se kod K grupe ne može uočiti značajno povećanje, međutim na osnovu AS može se uočiti da se TM povećala sa 77,98 kg na 79,22 kg. Suprotne rezultate dobio je Rohimi (2006). Autor navodi da se TM statistički značajno smanjila sa

84 kg na 66 kg posle 12 nedelja treninga sa opterećenjem (85%1RM 5 serija i 6 ponavljanja) kod ispitanika koji su pripadali populaciji gojaznih (Rohimi, 2006). U BAZM i MASM kod VP grupe mogu se uočiti značajne promene ($p < .05$)*, BAZM se povećala za 2,3%, a MASM smanjila za 2,2%, dok se kod K grupe te promene ne uočavaju. Slične rezultete dobili su Willoughby i sar. (2006) ali kod netreniranih muškaraca BEZM povećala se za 2,7% a MASM se smanjila za 1,38%. U tabeli br. 2 može se uočiti da postoji značajna razlika između VP i K grupe u celokupnom sistemu analiziranih varijabli na finalnom merenju ($p < .05$)*. Ukoliko, pojedinačno analiziramo BEZM, MASM i MM na finalnom merenju mogu se uočiti razlike između VP i K grupe, dok se kod TM ne vidi statistički značajna razlika. AS pokazuju bolje rezultate u VP grupi. Na osnovu svega navedenog može se zaključiti, da trening sa opterećenjem uz unos 1g/kg vež proteina 4x nedeljno u toku 12 nedelja, ostvaruje drugačije efekte na telesni sastav, nego samostalan trening sa opterećenjem kod sportista studenata.

LITERATURA

Baer, D., Stote, K., Pul, D., Harris, K., Rumler, W., i Clevidence, B. (2011). Whey protein but not soy protein supplementation alters body weight and composition in free-living overweight and obese adults. *The Journal of Nutrition*, 141(8), 1489-1494.

Brown, E. C., DiSilvestro, R. A., Babaknia, A., i Devor, S. T. (2004). Soy versus whey protein bars: effects on exercise training impact on lean body mass and antioxidant status. *Nutrition Journal*, 3(22).

Burd, N.A., Tang, J. E., Moore, D. R., i Phillips, S. M. (2006). Exercise training and protein metabolism: influences of contraction, protein intake and sex-based differences. *Journal of Applied Physiology*, 106(5), 1692-1701.

Butterfield G., Cady C., i Moynihan S. (1992). Effect of increased protein intake on nitrogen balance in recreational weight lifters. *Medicine in Science Sport Exercise*, 24(71), 14-22.

Campbell, W. W., Crim, M. C., Young, V. R., Joseph, L. J., i Evans, W. J. (1995). Effects of resistance training and dietary protein intake on protein metabolism in older adults. *Am.J.Physiol*, 268(6), 1143-1153.

Candow, D. G., Burke, N. C., Smith-Palmer, T., i Burke, D. G. (2006). Effect of whey and soy protein supplementation combined with resistance training in young adults. *Int J Sport Nutr Exerc Metab*, 16(3), 233-244.

Cermak, N., Res, P., de Groot, L., Saris, W., i Loon L. (2012). Protein supplementation augments the adaptive response of skeletal muscle to resistance-type exercise training: a meta-analysis. *Am. J. Clin. Nutr*, 96, 1454-1465.

Di Pasquale, M. G. (1999). Proteins and amino acids in exercise and sport. Energy – Yielding Macronutrients and Energy Metabolism in Sports Nutrition.

Haub, M. D., Wells, A. M., Tarnopolsky, M. A., i Campbell, W. W. (2002). *Effect of protein source on resistive-training-induced changes in body composition and muscle size in older men. The American journal of clinical nutrition* , 76, 511-517.

Hoffman, J.R., Ratamess, N. A., Tranchina, C.P, Rashti, S.,L., Kang, R. J i Faigenbaum A.D. (2009). Effect of Protein-Supplement timing on Strength, Power, and Body-Composition Changes in Resistance- Trained Men. *International journal of Sport Nutrition and Exercise Metabolism*, 19, 172-185.

Joy, J.M., Lowery, R.P., Wilson, J. M., Purpura, M., O De Souza, E., MC Wilson, S., Kalman, D.S., Dudeck, J. E., i Jager, R.J. (2013). The effects of 8 weeks of whey or rice protein supplementation on body composition and exercise performance. *Nutrition Journal*, 12 (86), 1-7.

Kerksick, C. M., Rasmussen, C, J., Lancaster, S. L., Magu, B., Smith, P., Melton, C., Greenwood, M., Almada, A. L., Earnes, C.P., i Kreider, R. (2006). The effects of protein and amino acid supplementation on performance and training adaptations during ten weeks of resistance training. *Journal of strength & conditioning research*, 20 (3) 643-653.

Lemon, P.W., Tarnopolsky, M.A., MacDougall, J.D., i Atkinson, S.A. (1992). Protein requirements and muscle mass/strength changes during intensive training in novice bodybuilders. *Journal of Applied Physiology*, 73, 767–775.

Tipton, K. D., Rasmussen, B. B., Miller, S. L., Wolf, S. E., Owens-Stovall, S. K., Petrini, B. E., i Wolfe, R. R. (2001). *Timing of amino acid-carbohydrate ingestion alters anabolic response of muscle to resistance exercise. American journal of physiology. Endocrinology and metabolism*, 281, 197-206.

Rahimi, R. (2006). Effect of moderate and high intensity weight training on the body composition of overweight men. *Facta Universiatis*, 4 (2), 93-101.

Willoughby, D. S., Stout, J. R., i Wilborn, C. D (2007). Effects of resistance training and protein plus amino acid supplementation on muscle anabolism, mass, and strength. *Amino Acids*, 32 (4), 467-77.

Wolfe, R.R. (2001). Effects of amino acid intake on anabolic processes. *Can. J. Appl. Physiol*, 26 (1), 220-227.

World Medical Association (2002). World Medical Association Declaration of Helsinki: Ethical Principles for Medical Research Involving Human Subjects.

Zaciorski, V., i Kremer, V. (2009). *Nauka i praksa u treningu sange*. Data Status.

Age-group differences in vertical jump performance of young female gymnasts

Aleksandra Aleksić-Veljković¹, Dejan Madić¹, Katarina Herodek², Mila Vukadinović¹

¹Faculty of Sports and Physical Education, Novi Sad, Serbia

²Faculty of Sports and Physical Education, Niš, Serbia

ABSTRACT

Jumps are very important for success in artistic gymnastics in all levels of competitions. The aim of the study was to give more information about jumping abilities of young female gymnasts, participating in an international competition. We examined age differences in variables of counter-movement jump (CMJ) and counter-movement jump with arm swing (CMJA) between three age categories of young female gymnasts from different countries (n=47). First age group included 16 gymnasts (8 to 10 years old, body height 133.18 cm, body mass 29.52±3.45 kg) second group 15 gymnasts (10 to 12 years old, body height 143.31±731 cm, body mass 33.93 kg) and third group 16 gymnasts (12 to 14 years old, body height 152.16±7.66 cm, body mass 43.20±8.26). All gymnasts participated in the International Competition in gymnastics. The results indicate that there is a statistically significant difference between age groups in height of the jumps and peak power of the both jump protocols. The difference is in a favor of the older age groups. In other variables: depth of the centre of gravity displacement before the take-off and relative maximal power of jump at CMJ and CMJA, there were no significant differences between gymnasts.

Key words: Artistic gymnastics, explosive leg power, counter-movement jump, counter-movement jump with arm swing.

INTRODUCTION

As a basic sport, artistic gymnastics affects development of motor abilities: strength, coordination, flexibility and balance. Gymnastic elements are mostly

complex movements which require explosive strength and jumping abilities on the high level of performance. Height of the vaults, jumps and acrobatic elements on the balance beam and floor are one of the most important components of technical requirements of successful execution of gymnastics elements. Gymnasts' ability to transmit impulse from their feet to their upper bodies following rebounds is crucial, allowing acrobatic skills such as somersaulting and twisting (Mkaouer et al., 2011). Bouncing as one of the most important movements on the floor and vault is present since a very early age as a part of young gymnasts' daily training routines (Marina & Torrado, 2013). The vertical jump assessments are designed to assess the explosive strength of the lower limbs in different subjects. One of the most used protocols of testing vertical jumping ability is using of tensiometric platforms where subjects perform unilateral and bilateral single jumps (SJ, CMJ, VJ, DJ) and a series of jumps (4CMJ and 60CMJ). Counter-movement jump (CMJ) contains an eccentric and a concentric phase that constitute a stretch-shortening cycle and they are associated with many dynamic movements, including running, bounding, and tumbling, and depend on contractile elements, elastic properties of the muscle and connective tissue (Kinser et al., 2008). Testing and periodical monitoring of young athletes' abilities is necessary for success in senior category. Those informations are important for planning and making training programs adapted to the needs of gymnastics and the gymnasts' age. In this way we could achieve a harmonious and healthy development of fundamental motor skills in accordance with the physical development of athletes (Ricotti, 2011).

So far in the literature, the authors have described significant differences in jumping abilities between trained and untrained subjects (Kums et al., 2005) national and university teams (Smith, Roberts, & Watson, 1992) and different age categories of the athletes (Buško et al., 2012). Researches investigated jumping performance of gymnast's of different age, gender and levels (Swartz et al., 2005; Marina, Jemni, & Rodríguez, 2013). Comparing with match control groups, there were greater, more significant differences between the female gymnasts and the control group, than between the male gymnasts and the male control (Marina et al., 2013). Mentioned authors also reported significantly increased differences, especially in men, when counter-movement jump and counter-movement jump with arm swing were normalized to the body mass ($p < 0.001$).

Earlier findings of authors suggest that almost every investigated parameter in counter-movement jumps were affected by age (Focke et al., 2013). Jumping capabilities are crucial in gymnastics in all levels of competitions and in all categories of gymnasts, but for the best of our knowledge there are not researches in the categories of the young gymnasts that are already competing on the international level. These gymnasts are already selected as talented in their countries and can be seen as future representatives of their countries at major competitions. Therefore, the aim of our study was to determine differences in chosen variables of counter-movement jumps without (CMJ) and with arm swing (CMJ), in young female gymnasts (8 to 14 years old), competing in three age groups on the international competition.

Methods

Subjects

Forty-seven young female gymnasts, national team members from eight European countries (Slovenia, Croatia, Austria, Denmark, Sweden, Romania, Bulgaria and Serbia), took part in this investigation. The physical characteristics of the participants are shown in Table 1.

Table 1. Descriptive characteristics of the participants: Means (\pm standard error).

	N	Age-group (years)	Body height (cm)	Body mass (kg)
Group 1	16	8 -10	133.18 (5.38)	29.52 (3.45)
Group 2	15	10 -12	143.31 (7.33)	33.93 (4.59)
Group 3	16	12 - 14	152.16 (8.26)	43.21 (8.26)

The subjects were informed about the scope and protocol of the study, and of the possibility to withdraw from the study at any moment. They were training for six days a week (one or two training sessions per day) for approximately 48 and 34 hours per week and participated in competitions according to the national and the international calendar of the International Federation of Gymnastics. The gymnasts were free of injury and testing was performed on training two days before competition. The gymnasts were tested after their usual warming up. All parents and coaches submitted their written consent for participating of gymnasts according to Helsinki Declaration (WMA). The study was granted approval of the Research Ethics Committee.

Procedures

The vertical jump tests (counter-movement jump and counter-movement jump with arm swing) were measured by Kistler QuatroJump 9290AD and performed according to the protocols described in Bosco (1992) and criteria for correct trials of jumps was according to Acero et al. (2011). During testing, the air temperature ranged from 24°C to 27°C. Testing commenced at 10 a.m. and was completed by 1 p.m. Participants were asked to perform six vertical jumps three with their hands placed on their hips in order to minimize arm contribution to leg extensor assessment (CMJ), and three with arm swing (CMJA). Basic anthropometric parameters (body height and body mass) were registered in the study protocol.

We included four variables of counter movement jump (CMJ): SVIS - Height of the performed jumps (cm); DPTT - Depth of the centre of gravity displacement before the take-off (cm); SNKG - The relative maximal power of jump (W/kg); Peak power, according to equation proposed by Sayers et al. (1999): $SPP(W) = 60.7 \times \text{jump height (cm)} + 45.3 \times \text{body mass (kg)} - 2,055$. Counter-movement jump with arm swing (CMJA) variables: ZVIS - Height of the performed jumps (cm); ZPTT - Depth of the centre of gravity displacement before the take-off (cm); ZNKG - The relative maximal power of jump (W/kg) and Peak power ZPP (W), according to the same equation (Sayers et al., 1999).

Statistical analysis

For statistical analysis of the data, software SPSS version 20 was used. Descriptive statistics and reliability of testing for all variables were calculated. The jump height, relative maximal power of jump and depth of body center of gravity displacement for both protocols were compared between groups by using a one-way analysis of variance (ANOVA). The criterion for establishing statistical significance was $p < .05$.

RESULTS

Table 2 shows results of descriptive statistics, reliability and ANOVA analysis of CMJ and CMJA jumps of the gymnasts.

Table 2. Descriptive statistics, reliability and age-group differences of variables

Variable	Group 1				Group 2				Group 3				ANOVA	
	Mean	SD	ICC	CA	Mean	SD	ICC	CA	Mean	SD	ICC	CA	F	p
SVIS (cm)	32.02	4.09	.915	.970	35.79	4.58	.876	.955	36.39	4.57	.860	.948	4.59	.01
DPTT (cm)	18.30	4.98	.771	.886	18.72	4.12	.455	.715	20.27	2.84	.377	.645	1.03	.36
SNKG (W/kg)	21.72	2.48	.602	.820	23.93	3.45	.746	.898	23.29	3.43	.731	.891	2.04	.14
SPP (W/cm/kg)	1098.13	333.91	-	-	1509.89	378.71	-	-	1994.84	563.41	-	-	16.80	.00
ZVIS (cm)	39.29	4.19	.854	.946	43.68	5.01	.872	.953	46.12	6.02	.868	.952	7.24	.00
ZPTT (cm)	18.93	4.27	.811	.928	17.92	5.42	.896	.963	17.86	5.16	.813	.929	.23	.79
ZNKG (W/kg)	23.49	5.19	.802	.924	25.74	5.88	.715	.883	23.38	6.89	.805	.925	.74	.47
ZPP (W/cm/kg)	1475.92	359.12	-	-	1919.56	364.61	-	-	2499.24	631.64	-	-	18.95	.00
F=3.83, P<0.005, Wilks' Lambda=.000														

Legend - Mean- arithmetic mean; SD-standard deviation, ICC- Interclass Correlation Coefficient, CA - Cronbach's alpha, F- F ratio; p-statistical significance between groups (p<0.05)

As showed in Table 2 the older gymnasts jumped higher than younger gymnasts (36.39±4.57, 35.79±4.58 vs. 32.02±4.09 cm) and that the values of the SPP were significantly different (p<.005). Variables DPTT, ZPTT, SNKG and ZNKG do not differ between categories.

DISCUSSION

The goal of the present study was to determine age-group differences in vertical jump performance. Results indicate that there is a statistically significant difference between age groups in height of the jumps and peak power of the both jump protocols. Differences in height of the jumps and maximum power showed that the older gymnasts have achieved better results as it was expected. Except maturation which affects the development of power, the training process and selection of gymnasts are also reasons for these results. In the youngest category, the success on the competition does not depend largely on this ability, because of the smaller number of acrobatic elements. In the older age categories it's necessary to have higher level of this ability, especially at the oldest category. Gymnasts aged 14-16 perform a large number of acrobatic elements and high value jumps. The selection process is focused on the selection of gymnasts that can meet the high demands of gymnastics in junior and senior categories. Depth of the centre of gravity

displacement before the take-off wasn't significantly different so we can conclude that all gymnasts had similar technique of initial jump positions, mainly characterized by the degree of flexion at the hips and the knees. Also the relative maximal power measured in both jumps wasn't significantly different. This is in agreement with the study of Buško et al. (2012). These results can be consequences of different abilities of gymnasts in spite of the fact that they are competing in the same category.

Jump reliability reported in our study (9-28%) is higher than it was in previous researches. Marina & Torrado (2013) reported reliability from 1.57 to 2.35% in the group of fifty young female gymnasts, 8.84±0.62 years old. Variability in vertical jump tests is higher among younger respondents and increases with age. Some studies have shown that this ability reaches a level of adults aged 15 to 16 years, as well as greater reliability scores. Three of the four all-around apparatus in women gymnastics require a power of lower limbs, especially when performing acrobatic elements, so young gymnasts begin practicing vertical jumps at an early age (from 5 to 8 years) (Marina and Torrado, 2013).

The authors reported that three vertical jump protocols are of great importance to gymnastics: jumps from squat (in a few cases), jumps with the previous movement in the opposite direction of the jump (countermovement - characteristic of the elements on the shaft) and fast plyometric jumps, with so-called "rebound" effect, typical for the floor and balance beam. If a gymnast is not successful doing an acrobatic jump, the problem could be either related to jumping capacity, the specific technique and coordination of the movement, or both (Marina & Torrado, 2013). Kums et al. (2005) concluded that young elite female rhythmic gymnasts (12-13 years old) have greater jump height in CMJ than untrained female. Active subjects jumped higher than the sedentary group and showed lower variability during consecutive performance. These results suggest that physical activity and sport experience enhances jumping performance (Richter et al., 2010). Temfemo et al. (2009) compared vertical jumping performances in girls during growth, and reported that jumping performance increases during growth. This is in agreement with our research when analyzing height of jump in CMJ and CMJA because the oldest gymnasts aged 12 to 14 years (group 3) achieved greater results in height of jump (SVIS) and height of jumps with arms swing (ZVIS) than gymnasts from younger age categories (group 1 and 2). Significant age effects were found for jump height and jump height variability. Richter et al. (2010) reported significant increase in

jump height with age increasing over six age groups and a significant decrease in jump height variability until the age of 9 years. Height, power and body mass values were larger in girls aged 14.

CONCLUSION

Our research has shown that age-related differences were observed in jump heights and peak power of the jumps between three age groups of female gymnasts. The differences between them were not statistically significant in maximal relative power output in CMJ and CMJA and in depth of the centre of gravity displacement before the take-off.

ACKNOWLEDGMENTS

The authors would like to thank the Serbian Ministry of Education and Science for financing the project Biomechanical Efficiency of the Elite Serbian Athletes, OI 179019. We would also like to thank the international athletes who participated in this project and Gymnastics Federation of Serbia for their support.

REFERENCES

- Acero, R.M., Fernandez-del Olmo, M., Sanchez, J.A., Otero, X.L., Aguado, X., & Rodriguez, F. A. (2011). Reliability of squat and countermovement jump tests in children 6 a 8 years of age. *Pediatric Exercise Science*, 23, 151–160.
- Bosco, C. (1992). *Evaluation and control of basic and specific muscle behavior Part 2*. Track Technique. 3947-3951.
- Buško, K., Michalski, R., Mazur, J., & Gajewski, J. (2012). Jumping abilities in elite female volley-ball players: comparative analysis among age categories. *Biology of Sport*, 29(4), 317-319.
- Focke, A., Strutzenberger, G., Jekauc, D., Worth, A., Woll, A., & Schwameder, H. (2013). Effects of age, sex and activity level on counter-movement jump performance in children and adolescents. *European Journal of Sport Science*, 13(5). 518-526.
- Kums, T., Erelina, J., Gapeyeva, H., & Paasuke, M. (2005). Vertical jumping performance in young rhythmic gymnasts. *Biology of Sport*, 22(3), 237-246.
- Kinsler, A. M., Ramsey, M. W., O'Bryant, H. S., Ayres, C. A., Sands, W. A., & Stone, M. H. (2008). Vibration and stretching effects on flexibility and explosive strength in young gymnasts. *Medicine and Science in Sports and Exercise*, 40(1), 133-140.

Marina, M. & Torrado, P. (2013). Does gymnastics practice improve vertical jump reliability from the age of 8 to 10 years? *Journal of Sport Sciences*, 31(11), 1177-1186.

Marina, M., Jemni, M., & Rodríguez, F. J. (2013). Jumping performance profile of male and female gymnasts. *Sports Medicine and Physical Fitness*, 53(4), 378-86.

Mkaouer, B., Jemni, M., Amara, S., Chaabèn, H., & Tabka, Z. (2011). Kinematic and kinetic analysis of counter movement jump versus two different types of standing back somersault. *Science of Gymnastics Journal*, 4(3), 61-71.

Richter, A., Jekauc, D., Woll, A. & Schwameder, H. (2010). Effects of age, gender and activity level on counter-movement jump. In R. Jensen, W. Ebben, E. Petushek, C. Richter & K. Roemer (eds). *Proceedings of the 28. International Symposium on Biomechanics in Sports*, (pp. 266-269). Marquette: Northern Michigan University.

Ricotti, L. (2011). Static and dynamic balance in young athletes. *Journal of Human Sport and Exercise*, 6(4), 616-628.

Sayers S.P., Harackiewicz D.V., Harman E.A., Frykman P.N., & Rosenstein M.T. (1999). Cross-validation of three jump power equations. *Meicine Science of Sports Exercise*, 31: 572–577.

Smith, D.J., Roberts, D., & Watson, B. (1992). Physical, physiological and performance differences between Canadian national team and universiade volleyball players. *Journal of Sports Sciences*, 10.131-138.

Swartz, E., Decoster, L., Russell, P. & Croce, R. (2005). Effects of developmental stage and sex on lower extremity kinematics and vertical ground reaction forces during landing. *Athletic Training*, 40(1), 9-14.

Temfemo, A., Hugues, J., Chardon, K., Mandengue, S. H., & Ahmaid, S. (2009). Relationship between vertical jumping performance and anthropometric characteristics during growth in boys and girls. *European Journal of Pediatrics*, 168(4), 457-464.

Running and serious leisure perspective

Saša Pišot

*University of Primorska, Science and research centre, Institute for kinesiology
research, Koper, Slovenia*

ABSTRACT

Running as a mean and a path to physical fitness, health and wellbeing became a world revolution and popular “brand” of a healthy lifestyle. Running a marathon or a half marathon in Slovenia also became one of the fastest growing sport activities reflected in mass sport participation at recreational running competitions or events.

This phenomenon needs a different perspective in researching who the runners are and what are their relations to their leisure time? This was also the aim of this research - to analyse who run a marathon and a half-marathon in Slovenia and how running affect to runner’s leisure time. From the point of Stebbins’s (2007) Serious Leisure Perspective – the theoretic framework that synthesises three main forms of leisure: serious leisure, casual leisure and project-based leisure, we have analysed runners as amateurs and hobbyists. The sample of 260 runners of the 1st Istrian marathon 2014; marathon runners on 42 km (14 females, ± 41.4 years and 60 males ± 42 years), half-marathon runners on 21 km (85 females; ± 41 years and 101 males 41.4 years), was analysed in the frame of serious leisure perspective, especially their running pursuit. According to results, we can conclude that running as “serious leisure” activity for runners is highly substantial (more than 90% runners systematically prepared themselves for the competition) and fulfilling (“to compete with myself”; “to improve health and physical fitness” and “to diminish stress” were the most common answers of motive for run). Running as a “career” in acquiring and expressing a combination of its special skills, knowledge, and experience could be found in runner’s answers of their time practicing running (between 60 to 80% of them practise running from 5 years to 10 years and more, the majority of marathon runners run 30 to 50 km per week, female runners slightly

less; and half-marathon runners between 20 and 50 km per week; mostly 3 to 5 times per week). We notice a fair level of knowledge of sport nutrition and their willingness to spend more than 600 euros per year for sport equipment, fees and other. Because of the obtained results were quite interesting, more characteristics of running as serious leisure will be studied within the scope of the next Istrian marathon in 2015.

Key words: running habits, serious leisure perspective, male and female runners profile

INTRODUCTION

Running as a mean and a path to physical fitness, health and wellbeing became a world revolution and popular “brand” of a healthy lifestyle. Slovenia also faces the running fever as the rest of Europe where 50 million people estimated to run on a regular basis (Scheerder & Breedveld, 2015). According to the research (Pori et al., 2010) approx. 30,000 adults in Slovenia run regularly, which represents 2% of the adult Slovenian population. There is no doubt that running has become one of today’s most popular activities. Running a marathon or a half marathon has in Slovenia also become a very popular mass sport type of participation at recreational running competitions or events. The flow of the running subculture still rises and that phenomenon needs a different perspective in researching who the runners are and what are their relations to their leisure time. The increase in running activity can mostly be attributed to running events and commercial initiatives via social media and sport industry. In the last decade, we have evidenced the rise from 41 running sport events in 2004 to over 100 events in 2013 (Olympic committee, 2013). Those issues were our main focus in this paper; to analyse the characteristics of runners and their relation to leisure time on the sample of runners of a new sport event on the Slovenian coast – the Istrian marathon.

From the point of Stebbins’s (2006) Serious Leisure Perspective – the theoretic framework that synthesises three main forms of leisure: serious leisure, casual leisure and project-based leisure, we have analysed runners on 42 km and 21 km distance as amateurs who run at the 1st Istrian marathon.

Leisure is defined (Stebbins, 2006) as unforced activity engaged in during free time, which people want to do and, in either a satisfying or a fulfilling way (or both) and use their abilities and resources to succeed at this. Meanwhile

“free time” is time away from unpleasant obligation. Pleasant obligation being treated here as essentially leisure; since “leisure man” in fact feels no significant coercion to enact the activity in question. Free choice is intentionally omitted from this definition, because choice generally is never completely free, but rather limited with all sorts of conditions.

In the Serious Leisure Perspective Stebbins (2006) also defines the “core activity perspective” where “core activity” is a distinctive set of interrelated actions of steps that must be followed to achieve an outcome or product attractive to the participant. According to the Stebbins’ framework the core activity of running could be participation at a running sport event (running on time to certain distance). Also in running, the participant takes several interrelated steps to successfully run (or for example in other core activity ski downhill, rescue someone). Although core activity motivates people to participate in a larger leisure activity; the intensity, meaning and the context of appeal of this core vary across the three forms. For instance, in serious leisure, participants gain a sense of deep fulfilment from the core activity, whereas this is impossible in casual leisure. From that point serious leisure time could be called “committed leisure” as Tomlinson (1993) suggested, but although commitment is an important attitude in serious leisure, it is too narrow to serve as a descriptor of entire serious leisure perspective.

Serious Leisure Perspective (Stebbins, 2006) offers a classification and explanation of all leisure activities and experiences, as these two are framed in the social psychological, social, cultural and historical context in which each activity and accompanying experience take place.

From the point of subject who participated in serious leisure or its core activity we considered the runners as amateurs. The marginal view to leisure is evident for amateurs. They do not participate in popular leisure, so their form of leisure is closer to being work than any other. They are serious about their leisure and its core activity (running), sometimes they are preoccupied with sport activity what could reflect in fatigue and injuries. These are the reasons that are not rarely to be misunderstood by those of their associates, but they are still within the ambit of respectable society (Stebbins, 1979).

As we described, the aim of this paper is to analyse the profile of participants of 1st Istrian marathon from the point of Serious Leisure Perspective where main focus was on their amateurism, their core activity engagement (running) and its effect on their leisure time management (intensity, meaning and the context of appeal).

METHODS

For the purpose of collecting the main characteristic of runners participating in the 1st Istrian marathon, an online quantitative survey questionnaire "A profile of 1st Istrian marathon runner" was sent to all registered participants by e-mail. The research was conducted from 21st of January till 30th of April 2014 and consisted of 53 questions about socio-demographics characteristics, motive and running related habits and sport injuries at the end. The sample of participants consisted of those who fully completed the online questionnaire with expected response rate (16.5%), 337 participants, (176 males (52.2%) and 161 females (47.8%)). We divided participants into three different groups according to the distance they intended to run: a full marathon (42.195 km); a half-marathon (21.097 km) and recreational run (8.5 km) and additionally also by gender. The further analyses of data focused on the runners' running pursuit in the frame of the Serious Leisure Perspective, consisted of marathon runners on 42 km (14 females in average 41.4 years old, and 60 males in average 42 years old) and half marathon runners on 21 km (85 females in average 41 years old, and 101 males, in average 41.4 years old). Variables which define serious leisure; the *substantiality* as systematic physical preparation for running event, *fulfilling* of running from the point of runners motives of running; running as a *career* in expressing a combination of its special skills, knowledge and experience were examined through several questions. The substantiality was examined by data of systematic physical preparation, planned running activities during the week and their time dedicated to training. The fulfilment of running was analysed by Motivations of Marathoners Scales (56 examples) of Masters, Ogles in Jolton (1993). Amateur running as a career was examined by analysing the running history and experiences in sport event participation and by their knowledge about sport diet and consumption habits dedicated to sport participation.

RESULTS

Serious leisure perspective obtained analysed data of how structured, organised and planned is serious leisure and its core activity – running. Results showed that running as "serious leisure" or "core activity" is highly substantial. More than 90% runners systematically prepared themselves for the competition with planned amount of sufficient running kilometres. Marathon runners in majority ran from 30 to 50 km/week and one third of them even more than 50 km, while female marathon runners run slightly less. Half marathon runners

(not related to gender) are divided mostly in two equal groups; those who run from 21 to 30 km per week and those who run 30 to 50 km per week and are apparently more enthusiastic. Running as a self-fulfilling activity (in Figure 1) showed that “to compete with myself”; “to improve health and physical fitness” and “to diminish stress” were the most common answers to the question with regard to the motivation for running. We can find the gender differences which are related also to running distance, where female marathon runners reported “to diminish stress” as the main motive for running, while male marathon runners value that motive the lowest among all three stated motives.

Figure 1: The scale of three motives for defining the “fulfilment of running”

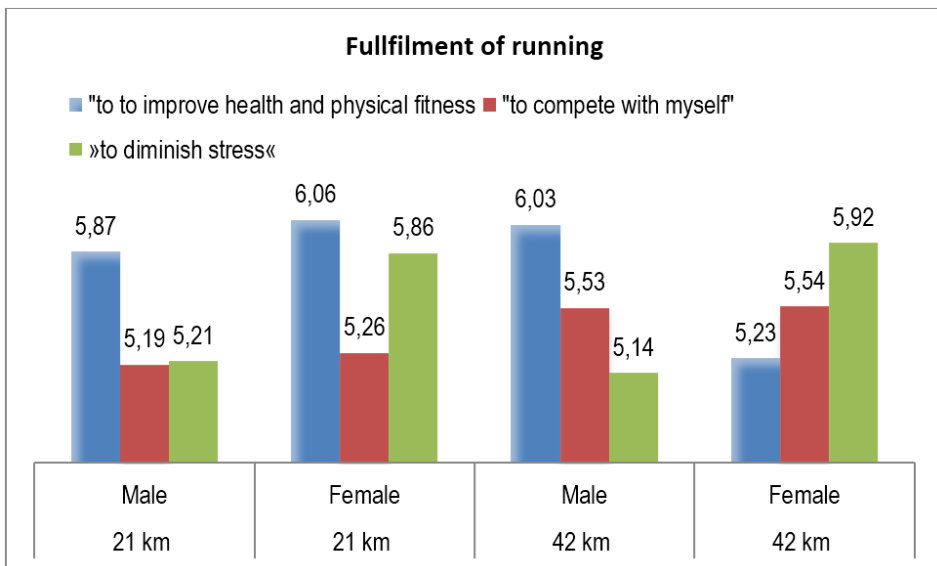

Source: Rameša & Pišot, 2014

Running as a career in acquiring and expressing a combination of its special skills, knowledge, and experience could be found in runners’ answers of their time practicing running (between 60–80% of them ran from 5 years to 10 years and more, most of them ran in average 3 times during the week and often at weekends. Female marathon runners have the most short running career (4–5 years), meanwhile 60% of male marathon runners run from 5 to more than 10 years. That also reflects the experience in participating at sport events, where almost one quarter of male marathon runners participated more than 10 times in the marathon run, while none of our female marathon runners participated more than 5 times. With regard to practicing sport nutrition, we found that the

INVITED LECTURES
POZVANA PREDAVANJA

50% of male marathon runners and 28% female marathon runners, 37% male and female half marathon runners have had a more healthy diet since they started running. A lower percentage, just one third of the runners reported about “the chasing the golden hour after run” and proper timing of meals. We found also a lower share (less than 1/10) of runners who consume sport supplements (energy bars, minerals, etc.). An important factor of relevance of running as career was reflected also in the runners’ willingness to spend more than 600 euros per year for sport equipment, fees and other (Figure 2 and Figure 3).

Figure 2. The running history of participants – building a career

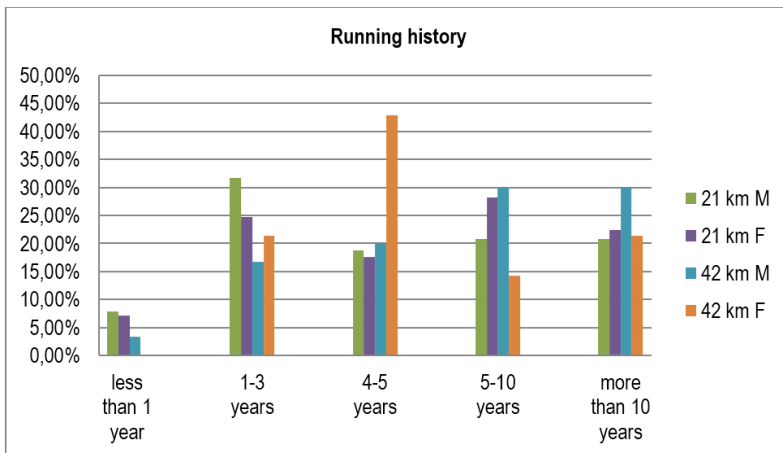
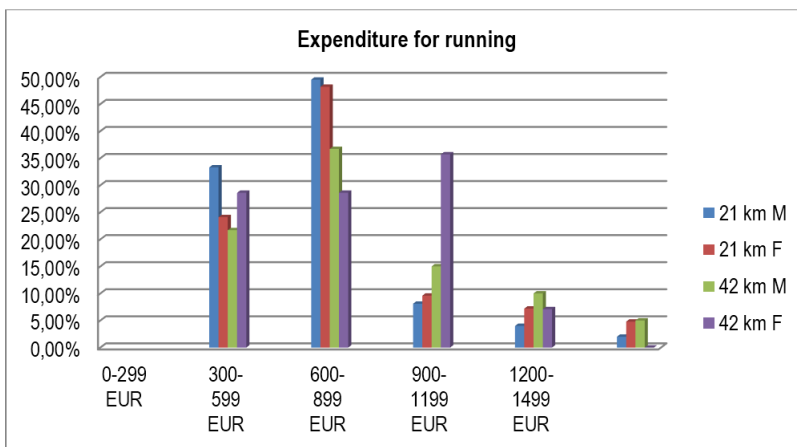

Figure3: The average expenditure for running activity on a yearly basis in EUR



Source: Rameša & Pišot, 2014

INVITED LECTURES
POZVANA PREDAVANJA

DISCUSSION

Results confirm the existence Serious Leisure Perspective characteristics in the group of amateur runners. Running and sport events (marathon) participation as core activity is represented as very *substantial* (systematically planned core activity for competition in sport event) and *fulfilling*, because for the majority of respondents the motive for running is the competition with themselves, the improvement of health and physical fitness and consequently to diminish stress. Running as a career in acquiring and expressing a combination of its special skills, knowledge, and experience was found in the proportion of runners' time devoted to running (5–10 years or longer running career, precise weekly and weekends running schedule, etc.), most runners have adopted and expand the knowledge on their nutrition habits to sport activity. Their consumption habits as spending and willingness to spend and to participate at mass sport events were more evident than with recreational runners, which reflected the importance of their running activity as a serious leisure perspective. This could imply that serious leisure of amateurs is the time when the core activity (running) is carefully structured, organised, allows self-fulfilment and enables the opportunity to upgrade own special skills, knowledge, personal wellbeing and the positive self-identity and social identity (social respect).

CONCLUSION

Running a marathon and a half marathon in the presented case could be defined as running as a career. The runners devoted to running activity much of their leisure time, for more than 5 years of engagement, with planned running schedule. Although their position based on the amateur level, most runners have adopted and expanded the knowledge on nutrition habits to sport activity and exercise. They are also willing to spend and to participate at mass sport events more often than other recreational runners. The interesting results that we have obtained at the same time open additional questions in the research of the Serious Leisure Perspective, so more characteristics of amateur runners as the rising sport subculture will be studied within the scope of the next, the 2nd Istrian marathon in 2015.

REFERENCES

Cohen- Gewerc, E., and Stebbins, R. 2007. The Pivotal Role of Leisure Education: A Manifesto for This Century. State College, Venture, PA.

Olympic Committee of Slovenia (2013). Slovenija teče 2013 [Slovenia runs 2013]. Retrieved from: <http://www.olympic.si/sport-za-vse/slovenija-tece/predstavitev/> on 22 April 2015.

Pori, M. in Sila, B. (2010). Which are the most popular sport activities among Slovenes? *Šport*, 58 (1-2), 105-107.

Pišot, S. (2015). Profil tekačic in tekačev 1. istrskega maratona (The runner's profile of the 1st Istrian marathon). Zbornik predavanj 2. istrskega maratona [Elektronski vir] / ed. Plevnik M.[et al.]. - El. Book. Koper: Univerzitetna založba Annales. Retrieved from

http://www.istrski-maraton.si/images/2015/Zbornik_BK2IM_2015.pdf

Rameša M, & Pišot, S. Podatki Spletne ankete (2014): Profil tekačice in tekača 1. Istrskega maratona (Data analyses of on-line questionnaire: The profile of runners of the 1st Istrian marathon)

Scheerder, J. & Breedveld, K. (2015). Running across Europe. The Rise and Size of one of the Largest Sport Markets. Palgrave MacMillan. Retrieved from <http://www.palgraveconnect.com/pc/doi/10.1057/9781137446374.0001>

Stebbins, R.A. (1979). *Amateurs: On the Margin between Work and Leisure*, Sage.

Stebbins, R. A. (2006). Leisure Reflections 13. The Serious leisure perspective. LSA Newsletter no. 75. Retrieved from <http://www.seriousleisure.net/uploads/8/3/3/8/8338986/reflections13.pdf>

Stebbins, R. A. (2012). Leisure Reflections 29: Self-directed learning as a foundation for complex leisure. LSA Newsletter no.91. Retrieved from http://www.seriousleisure.net/uploads/8/3/3/8/8338986/reflections_29_secure_copy.pdf

Tomlinson, A. (1993) Culture of commitment in leisure: notes towards the understanding of a serious legacy. *World leisure & Recreation*, 35 (1), 6-9.

A comparative analysis of the jumping tempo of volleyball players at different levels of competition

Nikola Toplica Stojanović, Zvezdan Savić, Nebojša Randelović

Faculty of sport and physical education, University of Niš, Serbia

ABSTRACT

With the aim of studying the differences in the jumping tempo of volleyball players, the current study was based on a sample of 12 volleyball players, members of the Super League, and 13 volleyball players, members of the First Serbian Volleyball League. In order to evaluate the jumping tempo, three two-foot jump tests were applied: (two-foot quick jumps sideways, two-foot jumps to the side and jumping lunges) and four tests of single-leg jumps (left and right leg jumps back and forth, left and right leg jumps sideways). The results these participants scored had a normal distribution and had satisfactory sensitivity. Based on the results, we can conclude that there is a difference in the jumping tempo between the volleyball players of the Super League and First Serbian Volleyball League, which is manifested in the two-foot jumps and single-leg jumps in the frontal plane, the ones performed back and forth, while no difference was determined in the sideways two-foot and single-leg jumps.

Key words: comparative analysis, jumping tempo, volleyball players.

INTRODUCTION

Speed, as a human motor skill, enables the performance of simple or complex movements in a short period of time, and is the main factor in achieving a win in numerous sports disciplines (Željaskov, 2004). Speed emerges as a complex skill in many sports disciplines, one which includes several inter-connected factors (Čoh, 2003) and makes up the “speed potential of an individual” in a particular motor activity, wherein certain factors impose

as the dominant ones (Željaskov, 2004). Based on numerous studies, it was determined to take several forms, including speed of motor reaction, single movement speed and frequency speed (Gredelj et al., 1975; Hofman, 1980). Frequency speed represents the ability to quickly perform several connected simple or complex movements and plays an important part in sports in which the ability to quickly repeat uninterrupted, identical movements is dominant, including quick movements in simple jumps (Boher et al., 1993). Frequency speed primarily depends on the characteristics of the nervous system and the physiological characteristics of the activated muscles (Heimer & Matković, 1997). The game of volleyball is characterized by short and frequent actions of high intensity, which are accompanied by low-intensity activities and a recovery period (Polglaze & Dawson, 1992; Viitasalo et al., 1987). Among volleyball players, the metabolic pathways of keratin-phosphate and glycolysis are well developed, as is aerobic capacity (Smith, Roberts & Watson, 1992; Spence, Disch, Fred & Coleman, 1979; Viitasalo et al., 1987). By analyzing the results of previous studies and existing volleyball matches, it was determined that the requirements made on the neuro-muscular system are high during sprinting, falls, jumps and movements in all directions on the court (Dyba, 1982). During an attack sequence or defense, volleyball players use jumps of various structures, intensity and direction. During the game of volleyball jumps can be vertical or horizontal, on two feet or just one, and are performed in all directions (front, back and to the side). Logically, we can assume that volleyball players need to have well developed speed and muscle force, as well as the ability to repeat maximum effort with limited recovery periods during an entire match (Smith et al., 1992). The basic aim of this research was to determine the difference in the jumping tempo of the volleyball players of the Super League and First Volleyball League in Serbia.

THE METHOD

The sample of participants

This research was carried out on a sample of 12 volleyball players competing in the Super League, and 13 volleyball players competing in the First Serbian Volleyball League. The basic criteria for selection included the following: all of the participants were members of senior teams which competed in the national championship; all of the participants had at least six years of volleyball training and all of the participants were healthy during the testing.

The sample of measuring instruments

1. Two-foot jumps sideways (BSKB)
2. Two-foot jumps to the side (SKUS)
3. Lunge jumps (POUI)
4. Right leg jumps back and forth (SDNNN)
5. Left leg jumps back and forth (SLNNN)
6. Right leg jumps sideways (SDNB)
7. Left leg jumps sideways (SLNB)

The reliability, sensitivity and homogeneity of the first three newly-constructed tests involving jumping on both feet was confirmed in the study carried out by Stojanović et al. (2011).

The organization and description of the measuring process

1. Two-foot jumps sideways (BSKB)

Equipment: a stopwatch, 5 (five) small foam cone-shaped hurdles, 7cm in height, 8cm in width at the base, and 30 cm long. The small hurdles are positioned in parallel fashion at a distance of 60 cm, one behind the other.

The invigilators: there was one invigilator for each participant.

The overall duration of the test: the test is not finished until the participant jumps over all the hurdles in both directions.

The task: the participant stands with is right (left) side in front of the first hurdle. His arms hang freely by his sides. When the invigilator gives the mark NOW the participant jumps (both feet) over all five hurdles in a row in one direction. When he jumps over the final hurdle, he jumps over all five in the opposite direction. The invigilator measures the time from the mark NOW until the landing position that the participant assumes after jumping over the final hurdle. The free arm swing is used during the jump.

Evaluation: time is measured in seconds, with a precision of 1/10 seconds.

Instructions: the test is performed three times, and the average score is recorded.

2. Two-foot jumps to the side (SKUS)

Equipment: a stopwatch, one foam cone-shaped hurdle, 7cm high, 8cm wide at the base and 30 cm long.

The invigilators: there was one invigilator for each participant.

The overall duration of the test: 20 seconds.

The task: The participants stands sideways in relation to the hurdle. His arms hang freely by his sides. At the invigilator's mark NOW the participant jumps sideways first on one leg, then on the other, and vice versa. The free arm swing is used during the jump.

Evaluation: each sideways jump over a hurdle is recorded.

Instructions: the test is performed three times, and the average score is recorded.

3. Lunge jumps (POUI)

Equipment: a stopwatch, one foam cone-shaped hurdle, 7cm high, 8cm wide at the base and 30 cm long.

The invigilators: there was one invigilator for each participant.

The overall duration of the test: 20 seconds.

The task: The participant steps forward, so that the hurdle is between his feet. His arms hang freely by his side. At the invigilator's mark NOW the participant jumps upwards, changing his position so that he lands in the lunge position, with his other leg forward, and vice versa. The free arm swing is used during the jump.

Evaluation: each performed jump luge is recorded.

Instructions: the test is performed three times, and the average score is recorded.

4. and 5. Right leg jumps back and forth (SDNNN)

(the same test is performed for the left leg as well - SLNNN)

Equipment: a stopwatch, one foam cone-shaped hurdle, 7cm high, 8cm wide at the base and 30 cm long.

The invigilators: there was one invigilator for each participant.

The overall duration of the test: 20 seconds.

The task: The participant faces the hurdle, standing on his right leg, while his left leg is bent at the knee and suspended in the air. His arms hang freely by his sides. At the invigilator's mark NOW the participant jumps over the hurdle with his right foot forward and back right away without touching the hurdle. The free arm swing is used during the jump.

Evaluation: every jump is recorded.

Instructions: the test is performed three times, and the average score is recorded.

6. and 7. Right leg jumps sideways (SDNB) (the same test is performed for the left leg as well - SLNB)

Equipment: a stopwatch, one foam cone-shaped hurdle, 7cm high, 8cm wide at the base and 30 cm long.

The invigilators: there was one invigilator for each participant.

The overall duration of the test: 20 seconds.

The task: The participant stands sideways in relation to the hurdle, on his right leg, with his left leg bent at the knee and suspended in the air. His arms hang freely by his side. At the invigilator's mark NOW the participant jumps over the hurdle sideways without touching it. The free arm swing is used during the jump.

Evaluation: every jump is recorded.

Instructions: the test is performed three times, and the average score is recorded.

Statistical analysis

In order to obtain the basic parametric data, we applied the descriptive statistical analyses, where in addition to arithmetic means, the values of minimal and maximal scores were calculated, along with the range of the scores, standard deviations, the variation coefficient, as well as the skewness and kurtosis of the distribution. For information on the difference in the jumping tempo between the volleyball players of the Super League and First Serbian Volleyball League we applied the multivariate/univariate analysis of variance (one-way MANOVA/ANOVA). The results of the measuring were processed using the statistical package STATISTICA 7.1, (StatSoft, Inc., Tulsa, OK).

RESULTS

Tables 1. and 2. show the descriptive statistical parameters of the volleyball players of the Super League and First Serbian Volleyball League. By studying them, based on the values of the skewness (Skew.) and kurtosis (Kurt.) of the distribution curve, we can conclude that the results of these jumping tempo tests among the players of the Super League and First Serbian Volleyball

League had a normal distribution, which is the basic precondition for using the multivariate and univariate methods in further analysis. These methods were used to determine the differences between the groups. Only the lunge jump test (POUISK) and the right leg jump sideways test (SDNB) showed signs of positive skewness, which as a consequence of the results one participant scored. These results were significantly higher than the results of the others, and so the curve was bent towards the lower scores.

Table 1. The descriptive statistical parameters of the jumping tempo of the volleyball players of the Super League

	N	Mean	Min.	Max.	Range	Std.Dev.	Coef.Var.	Skew.	Kurt.
STAR	12	21.00	17.00	29.00	12.00	3.95	18.83	1.00	-0.04
BSKB0	12	3.79	3.28	4.42	1.14	0.32	8.50	0.48	-0.17
SKUSTR	12	49.17	39.67	62.00	22.33	5.83	11.86	0.52	1.25
POUISK	12	61.00	54.33	75.33	21.00	5.82	9.55	1.34	2.57
SDNNN	12	50.06	40.33	57.00	16.67	4.40	8.78	-0.94	1.23
SLNNN	12	49.56	41.00	59.00	18.00	4.27	8.62	0.18	2.50
SDNB	12	52.33	46.67	61.67	15.00	3.76	7.19	1.22	2.97
SLNB	12	50.86	43.00	62.00	19.00	5.43	10.67	0.46	0.29

Legend: **STAR** – the age of the participants; **N**- the number of participants; **Mean** - the means; **Min.** - minimal result; **Max.** - maximum result; **Std.Dev.** - the standard deviation of the arithmetic means; **Coef.Var.** – the variation coefficient; **Skew.**- the skewness of the distribution curve of the results; **Kurt.** - the kurtosis of the distribution curve of the results.

Table 2. The descriptive statistical parameters of the jumping tempo of the volleyball players of the First Serbian Volleyball League

	N	Mean	Min.	Max.	Range	Std.Dev.	Coef.Var.	Skew.	Kurt.
STAR	13	19.46	16.00	23.00	7.00	2.11	10.82	0.10	-0.68
BSKB0	13	3.95	3.41	4.53	1.12	0.33	8.37	0.13	-0.75
SKUSTR	13	48.28	41.67	57.33	15.67	4.34	9.00	0.48	0.42
POUISK	13	56.28	44.00	64.67	20.67	5.33	9.47	-0.73	1.30
SDNNN	13	45.85	32.67	54.67	22.00	5.52	12.04	-0.81	1.83
SLNNN	13	45.38	39.33	53.33	14.00	4.00	8.82	0.44	-0.43
SDNB	13	52.15	47.00	57.67	10.67	3.72	7.14	0.45	-1.20
SLNB	13	51.49	42.67	58.67	16.00	4.39	8.52	-0.30	0.07

Legend: **STAR** – the age of the participants; **N**- the number of participants; **Mean** - the means; **Min.** - minimal result; **Max.** - maximum result; **Std.Dev.** - the standard deviation of the arithmetic means; **Coef.Var.** – the variation coefficient; **Skew.**- the skewness of the distribution curve of the results; **Kurt.** - the kurtosis of the distribution curve of the results.

By means of the multivariate analysis of variance, we calculated the differences in the jumping tempo of the volleyball players of the Super League and the First Serbian Volleyball League at the multivariate level (Table 3.). By studying these results we can note that at the multivariate level, for the entire sample of variables of the jumping tempo, a statistically significant difference was determined for the group centroids ($Q = .038$).

Table 3. The multivariate analysis of the differences in the jumping tempo of the volleyball players of the Super League and First Serbian Volleyball League

Wilks Lambda	F	Effect - df	Error - df	Q
.462	2.83	7	17	.038*

Legend: **Wilks lambda** – the value of the coefficient of Wilk's test of group centroid equality; **F** – the value of the F-test coefficient for testing the significance of group differences; **Effect df, Error df** – the degrees of freedom; **Q** – the coefficient of the significance of the differences in the group centroids; * - the statistically significant level of the group centroids

Considering that the value of the coefficient for the significance of the differences between the group centroids at the multivariate level is smaller than the referent value ($Q = .038$), differences were expected in the variables of the jumping tempo at the univariate level.

By analyzing table 4., which shows the results of the analysis of variance at the univariate level, we can conclude that there is a difference in the lunge jumps variable (POUISK), in the right leg jump back and forth (SDNNN) and the left leg jump back and forth (SLNNN). It is clear that the volleyball players of the Super League were more dominant in the jumps which were performed back and forth, while no difference was determined for the two-foot sideways and single-leg sideways jumps (BSKBO, SDNB and SLNB).

Table 4. The univariate analysis of the differences in the jumping tempo of the volleyball players of the Super League and First Serbian Volleyball League

Variable	Mean SL	Mean PL	Difference	F (1; 23)	p
BSKBO	3.79	3.95	-0.16	1.65	0.212
SKUSTR	49.17	48.28	0.89	0.19	0.669
POUISK	61.00	56.28	4.72	4.47	0.045*
SDNNN	50.06	45.85	4.21	4.40	0.047*
SLNNN	49.56	45.38	4.18	6.35	0.019*
SDNB	52.33	52.15	0.18	0.01	0.906
SLNB	50.86	51.49	-0.63	0.10	0.753

Legend: **Mean SL** - the means of the Super League volleyball players; **Mean PL** - the means of the First Serbian Volleyball League volleyball players; **Razlika** – the difference in the arithmetic means; **F** – the value of the F-test coefficient used to test the significance of the differences; **df 1, df 2** – degrees of freedom; **p** – the coefficient of the significance of the differences in the means; * - the statistically significant level of the difference in the arithmetic means

DISCUSSION

In order to explain the obtained differences in the jumping tempo of the volleyball players of the Super League and First Serbian Volleyball League, it is necessary to additionally explain the mechanisms and cause and effect relations which join together this motor skill, and whose existence was proven in previous theories and research studies.

The jumping speed to a great extent is determined by the morphological characteristics of the players (height, weight, the length of their extremities, etc.), the physiological characteristics of the players (the speed of contraction of the muscle fibers), as well as the abilities acquired through the training process (the extent of the force, the technique used to perform the structure of the movement-jump etc.). The timely performance of a jump is an essential parameter of the effectiveness of performing the structure of the jump movement (Čanaki & Birkić, 2009). During the performance of a jump it is very important for volleyball player to make a move at a precise point in time (in a timely manner) upwards, forward, or to the side, which means that he should be interacting with the ball at the moment of his the most extended reach or before it is achieved (Stojanović et al., 2005).

What we should add to this is the knowledge that the most important factors of the jumping ability and jumping speed are the muscle and nervous system. It is well known that the size of explosive strength is determined by the abilities of the Abstract exertion of many muscle groups which take part in movement, under the conditions of full inter-muscle and intra-muscle coordination and the most suitable relationship between the components of speed and strength. In the muscle system, the relation between the quick and slow muscle fibers and the elasticity of the muscles and tendons is very important. If the quick muscle fibers are dominant, then the consequence is the greater percentage of the development of strength and speed. The most important characteristic of muscle and tendon elasticity is the utilization of elastic energy during the eccentric-concentric cycle. The contribution of the elastic characteristics to the muscle-tendon system is based on the speed of this transition (Čoh, 2004). The transition must be as quick as possible, that is, less than 260 milliseconds (Bosco, 1982; Zatsiorsky, 1995). During such a muscle contraction, in the same amount of time, for the same mechanical work, less chemical energy is spent, which enables greater movement speed than in the case of only a concentric contraction.

Explosive strength of the plyometric type can be analyzed as a motor skill from the standpoint of the system. The organization of this system as well

as the leading role of some element of that system will determine the type of explosive movement. A very important element of the plyometric system is the reactive ability of the movement apparatus. This includes the joint contribution of the myotatic reflex (or the muscle extension reflex, where the muscle contracts violently right after extension) and the force which is created when the passively stretched tissue reverts back into its original position. Within certain limits, quicker expansion makes a greater contribution to the explosive nature of the movement (Čanaki & Birkić, 2009).

The concept of accumulation of elastic energy, that is, energy which the deformation of viscous elastic tissue generates during an eccentric phase of movement, can be used during the concentric phase of muscle activity. This brings us to the concept of the muscle spindle reflex or myotatic reflex. It takes part in the eccentric-concentric contraction and is an important component in the overall control of the nervous system over body movement (Čoh, 1988).

Significant differences in the jumping tempo of the volleyball players of the Super League and First Serbian Volleyball League between single-leg jumps back and forth and lunge jumps can be justified by the part that the speed component plays, which to a great extent depends on genetic material, in favor of volleyball players who are competing in the Super League. This was justified considering the improved quality of competition in the Super League. Thus the quality and speed abilities of the players of the Super League are greater in comparison to those of the First Volleyball League.

CONCLUSION

Based on the results obtained in this research we can conclude that differences were determined between the volleyball players of the Super League and First Serbian Volleyball League, where the volleyball players of the Super League scored significantly higher results for the jumping tempo on the two-foot jump and single-leg jump back and forth. The results obtained in this study can be connected with the various qualities of the Super League and First Serbian Volleyball League competitions. The Super League of Serbia represents an elite competition, so there is a need for players with pronounced speed abilities, which are directly connected to the jumping tempo. This field should be studied further in detail considering that in the relevant literature there is not a lot of published information on this topic. Further studies should include a greater number of participants so that precise results could be obtained.

REFERENCES

Booher, L. D., Hench, K. M., Worrell, T. W., & Stikeleather, J. (1993). Reliability of three single leg hops tests. *Journal of Sport Rehabilitation*, 2, 165-170.

Bosco, C., Viitasalo, J.T., Komi, P.V., & Luhtanen, P. (1982a). Combined effect of elastic energy and myoelectrical potentiation during stretch-shortening cycle exercise. *Acta Physiologica Scandinavica*, 114, 557-565.

Dyba (1982). Physiological and activity characteristics of volleyball. *Volleyball Tech Journal*, 6(3), 33-51.

Gredelj, M., Metikoš, D., Hošek, A., & Momirović, K. (1975). Model hijerarhijske strukture sposobnosti. *Kineziologija*, 5(1-2), 7-81.

Heimer, S., & Matković, B. (1997). *Sportska fiziologija*. U: Milanović, D., (Ur). *Priručnik za sportske trenere* (pp. 161-244). Zagreb: Fakultet za fizičku kulturu.

Hofman, E. (1980). Kanoničke relacije antropometrijskih mjera i testova za procjenu brzine. *Kineziologija*, 10(3), 33-38.

Čanaki, M., & Birkić, Ž. (2009). Specifičnosti pliometrijskog treninga tenisača. *Hrvatski športskomedicinski vijesnik*, 24, 45-50.

Čoh, M. (1988). Razlike v testih odzivne moči med košarkarji in športniki nekaterih drugih športnih panog. *Trener*, 16(578), 32-46.

Čoh, M. (2003). Razvoj brzine u kondicijskoj pripremi sportaša. U: D. Milanović i I. Jukić (Ur.), *Kondicijska priprema sportaša, Zbornik radova međunarodnog znanstveno-stručnog skupa, Zagreb, 21. – 22. veljače 2003*, (pp. 229 – 238). Zagreb: Kineziološki fakultet.

Čoh, M. (2004). Metodika i dijagnostika razvoja skočnosti u kondicijskoj pripremi sportaša. *Kondicijska priprema sportaša, Zbornik radova*, (pp. 104-120). Zagreb: Kineziološki fakultet.

LaChance, P. (1995). Plyometric Exercise. *Strength Condition Journal*, 17(4), 16-23.

Polglaze, T., & Dawson, B. (1992). The physiological requirements of the positions in state league volleyball. *Sports Coach*, 15, 32-32.

Smith, D. J., Roberts, D., & Watson, B. (1992). Physical, physiological and performance differences between Canadian national team and universiade volleyball players. *Journal of Sports Sciences*, 10(2), 131-138.

Spence, D. W., Disch, J. G., Fred, H. L., & Coleman, A. E. (1979). Descriptive profiles of highly skilled women volleyball players. *Medicine and science in sports and exercise*, 12(4), 299-302.

Stojanović, T., Kostić, R., & Nešić, G. (2005). *Odbojka*. Banja Luka: Fakultet fizičkog vaspitanja i sporta.

Verhošanski, J.I. (1979). *Razvoj snage u sportu*. Beograd: NIP Partizan.

Viitasalo, J. T., Rusko, H., Pajala, O., Rahkila, P., Ahila, M., & Montonen, H. (1987). Endurance requirements in volleyball. *CANADIAN JOURNAL OF SPORT SCIENCES-REVUE CANADIENNE DES SCIENCES DU SPORT*, 12(4), 194-201.

Zatsiorsky, V.M. (1995). *Science and practice of strength training*. Champaign, IL: "Human kinetics".

Željaskov, C. (2004). *Kondicioni trening vrhunskih sportista*. Beograd: Sportska akademija.

Population size as a factor in countries' success in WTF taekwondo competitions

Dražen Čular¹, Igor Jelaska¹, Domagoj Pečko²

¹Faculty of Kinesiology, University of Split, Croatia

²Tae Kwon Do Center Zagreb - "Ban Keglević", Zagreb, Croatia

ABSTRACT

The aim of this research is to determine and explain the correlation between the success of countries at the World Taekwondo Championships and population size of individual countries. The sample consisted of 68 countries from all 6 continents whose representatives won medals at the World Taekwondo Championships from 1973 to 2013. Data was collected from 21 world championship tournaments and for the purpose of this research a total of 65 variables were analyzed, which included the number of gold, silver and bronze medals won by country at world championships from 1973 to 2013. The success of individual countries was calculated using a weighted linear combination based on the official scoring system of the World Taekwondo Federation (WTF) (gold = 7, silver = 3, bronze = 1 point). By applying a non-parametric correlation analysis it was determined that there is a moderate statistically significant correlation ($r=0.46$; $P<0.05$) between the success of countries at world championships and population size of individual countries. For further conclusions about the factors that contribute to the result-based success of countries, gross domestic product should probably be included, while also analyzing the trends in the relationship between population size and result-based success considering the variations over a longer time period.

Key words: efficiency, success, number of medals won, world championship

INTRODUCTION

The issue of identifying the variables which affect the distribution of medals at competitions of the highest level has been of scientific interest for some time (Ball, 1972; Grimes, Kelly, Rubin 1974; Levine, 1974). In professional practice an empirical model based on the data from 1960 to 1996 is well known, and the

basic model takes into account only the variables *population* and *gross domestic product (GDP) per capita* (Bernard, Busse, 2004). Other research indicates that some other variables also have an impact on the medals won by countries, so the model has been expanded and the variables *tournament host*, *planned economy*, *former Soviet Union* and *remaining medal share* have been added.

Research shows that past success at the Olympic Games is a significant predictor of a country's success at the next Olympic Games (Shughart and Tollison, 1993). By using regression analysis, the prediction for 23 out of 36 countries was within a deviation of 3 medals from the number of medals won in Sydney. Johnson and Ali (2000) take the following variables into consideration; *GDP per capita*, *host advantage*, *geographical proximity to the host country*, *political system* and *former colonial connections*. The results show that host advantage adds 12% to the chances of a country's success and that communist countries surpass other countries by approximately 12 medals. Research also shows that the wealth of a nation (GDP) is not the most important factor for winning a large share of Olympic medals (Krishna and Haglund, 2008). The probability that a country will win a medal increases with its population size, wealth and the amount of public information. Furthermore, Bian (2005) gives an empirical analysis of the different variables used to predict the medals a country will win. The paper uses the previously mentioned basic models and the data from the 1988, 1992, 1996 and 2000 Olympics. The results reflect the results from the previously mentioned research to a great extent.

According to the research mentioned above, the first variable is *population size* because the larger the population of a specific country, the greater the chances that said country will have potentially talented athletes. In a simplified model, this would imply that the percentage of the world's population living in a specific country would be the same as the percentage of medals that said country would win at the Olympic Games. The above mentioned can be expressed by the following formula (Bernard and Busse, 2004):

The expected medal share ($E(\text{medalshare}_i(t))$) of the i -th country at the Olympic Games at the moment t is calculated by dividing the medals the country will win with the sum of all medals that can be theoretically won. In an idealized model, the relative result (medal share) is equal to the population size of a country divided by the total population of the world.

Another frequently used variable is *the economic situation of the country*. The wealthier the nation, the more economic resources it can be expected to spend on the development of successful athletes. Research indicates that it is

better to use relative GDP per capita (Moosa and Smith, 2004) which gives a modified version of the above mentioned equation:

More precisely, the expected number of medals a country will win at the moment t is an unknown function depending on the population size, GDP and the organizational capabilities of a certain country (f).

Using only the number of medals won at the Olympic Games is not the most appropriate way of determining the most successful countries. For example, at the 2008 Olympic Games in Beijing, USA finished second behind China by the gold medal count in the final rankings, but ahead of China in the total medal count. This sparked much debate about which ranking system should be used. The World Taekwondo Federation has prescribed a model for evaluating the result-based success of teams at competitions (WTF rules Article 6) which shall be used for the purpose of our research. The TAEKWONDO WTF model of assigning points to results (7:3:1), i.e. gold – 7 points, silver – 3 points and bronze – 1 point.

In accordance with the above mentioned, the main aim of this research is to determine and explain the correlation between the success of countries at the World Taekwondo Championships and population size. It shall be necessary to determine the success of countries on the basis of total points won at world championships held so far (1973 - 2013) as an intermediate step, but also to determine the relative success of countries by the number of total points won at world championships held so far (1973 - 2013) with respect to population size.

METHODS

The sample consisted of 68 countries from all 6 continents whose representatives won medals at world championships in the period from 1973 to 2013. Data related to result-based success, i.e. the number of bronze, silver and gold medals won, was collected from the website www.taekwondodata.com. Data related to population size was collected from the World Bank database at the World Bank website <http://data.worldbank.org>. Data was collected from a total of 21 world championships, and for the purpose of this research, a total of 65 variables were analyzed: for each country the number of gold, silver and bronze medals (1973 - 2013) and the population size of individual countries.

The collected data was processed with Statistica programme for Windows 12.6. (StatSoft, Tulsa, USA). Total point success was calculated based on a weighted linear combination:

$$\text{TOTPTS} = 7 * \text{TOTGold} + 3 * \text{TOTSilver} + \text{TOTBronze}$$

The following descriptive parameters for the variables of point success were determined: the arithmetic mean (AM), standard deviation (SD), minimum (min) and maximum result (max). The normality of variable distribution was tested by a KS test. Furthermore, the coefficient of correlation between success and population size of countries was calculated. Countries were also ranked by their result-based success: based on the total points won at world championships held so far (1973 - 2013) and the number of total points won at world championships held so far (1973 - 2013) with respect to population size.

RESULTS AND DISCUSSION

Table 1 shows the descriptive statistical indicators of countries at the World Taekwondo Championships (1973 - 2013).

Table 1: Descriptive statistics of the success of countries at the World Taekwondo Championships (1973 - 2013) POPUL – total population size in millions, TOTPTS – total points, TOTPTS/POPUL – ratio of total points per million residents

	AM±SD	Min	Max	KS-p
POPUL	61.83 ± 167.34	0.16	1 337.71	>0.20
TOTPTS	49.23 ± 155.13	1.00	1225.00	>0.20
TOTPTS/POP	2.34 ± 4.17	0.01	2.48	>0.20

Legend: arithmetic mean±standard deviation - (AM±SD), minimum (MIN) and maximum result (MAX), significance of the KS test (KS- p)

Looking at Table 1, we can notice that the population size variable (POPUL) results indicate that countries ranging from relatively “small” ones with scarcely more than 150,000 residents to the most populous countries in the world with more than 1.3 billion residents won medals. The average number of points won per country is 49.23, and it ranges from 1 up to 1225 points. A very high data variability can be noticed.

Table 2 shows countries ranked by success based on the total number of points won at world championships held so far (1973-2013). Considering that results were achieved by countries from all 6 continents, it may be concluded that taekwondo is a global sport practiced in all parts of the world.

Table 2: Point rankings for individual countries at the World Taekwondo Championships (1973 – 2013)

COUNTRY NAME	G	S	B	TOTPTS	COUNTRY NAME	G	S	B	TOTPTS
Korea, Republic Of	158	30	29	1225	Gabon	1	0	0	7
Spain	22	22	60	280	Sweden	0	0	6	6
Taiwan, Province Of China	14	25	37	210	Kazakhstan	0	0	6	6
United States	13	19	47	195	Argentina	0	1	3	6
Turkey	10	18	30	154	Indonesia	0	2	0	6
Iran, Islamic Republic Of	11	16	18	143	Uzbekistan	0	2	0	6
Mexico	4	27	30	139	Serbia	0	0	5	5
Germany	5	12	32	103	Dominican Rep.	0	0	5	5
China	9	9	9	99	Jordan	0	1	2	5
France	6	10	15	87	Viet Nam	0	0	5	5
Netherlands	4	5	15	58	Norway	0	0	3	3
Canada	1	11	13	53	Switzerland	0	0	3	3
Thailand	3	5	11	47	Belarus	0	0	3	3
Croatia	2	5	10	39	Tunisia	0	0	3	3
Cuba	3	3	6	36	Senegal	0	0	3	3
Denmark	2	6	3	35	Saudi Arabia	0	0	3	3
Egypt	2	3	12	35	Guam	0	1	0	3
United Kingdom	2	6	3	35	Bahrain	0	1	0	3
Russian Federation	1	5	10	32	Portugal	0	1	0	3
Italy	0	5	15	30	Cyprus	0	0	2	2
Australia	1	1	17	27	Slovenia	0	0	2	2
Brazil	1	4	7	26	Finland	0	0	2	2
Greece	1	3	9	25	Austria	0	0	2	2
Philippines	0	5	6	21	Hungary	0	0	2	2
Azerbaijan	1	1	8	18	Belgium	0	0	2	2
Cote D'Ivoire	0	2	11	17	Guatemala	0	0	2	2
Morocco	0	3	7	16	Nepal	0	0	2	2
Mali	2	0	1	15	Malaysia	0	0	2	2
Ecuador	1	2	1	14	Costa Rica	0	0	1	1
Puerto Rico	0	2	2	8	Israel	0	0	1	1
Afghanistan	0	2	2	8	Uganda	0	0	1	1
Japan	0	1	5	8	Poland	0	0	1	1
Venezuela	0	1	4	7	Colombia	0	0	1	1
Chile	0	2	1	7	Nigeria	0	0	1	1

Legend: G – number of gold medals, S – number of silver medals, B – number of bronye medals, TOTPTS – total points (7 – gold, 3 – silver, 1 – bronze)

By analyzing the results of the points won at the World Taekwondo Championships from 1973 to 2013 given in Table 2, it may be stated that the Republic of Korea takes first place with 1225 points, and that the ranking of the first six countries stays the same regardless of the ranking method (the number of points or the number of gold medals won). The rankings given in Table 3 show the relative success of countries with regards to the number of total points won at world championships held so far (1973 - 2013). It is necessary to point out that the following formula was used to calculate the COEFF

$$COEFF = \frac{TotN}{Pop} \cdot 10^6$$

where *TotN* refers to the total number of points, and *Pop* refers to the population size.

Table 3: Relative point rankings of countries at the World Taekwondo Championships (1973 – 2013) - Total number of points per million residents

COUNTRY NAME	COEFF	COUNTRY NAME	COEFF
Korea	24.79	Italy	0.50
Guam	18.82	Egypt	0.45
Taiwan	9.08	Chile	0.41
Croatia	8.83	Switzerland	0.38
Denmark	6.31	Finland	0.37
Spain	6.08	Kazakhstan	0.37
Gabon	4.50	Belarus	0.32
Netherlands	3.49	Tunisia	0.28
Cuba	3.19	Portugal	0.28
Bahrain	2.40	Afghanistan	0.28
Greece	2.21	Venezuela	0.24
Puerto Rico	2.15	Austria	0.24
Turkey	2.13	Senegal	0.23
Azerbaijan	1.99	Russian Federation	0.22
Iran	1.92	Philippines	0.22
Cyprus	1.81	Costa Rica	0.21

Canada	1.55	Uzbekistan	0.21
France	1.34	Hungary	0.20
Germany	1.26	Belgium	0.18
Australia	1.22	Argentina	0.15
Mexico	1.18	Guatemala	0.14
Mali	1.07	Brazil	0.13
Slovenia	0.98	Israel	0.13
Ecuador	0.93	Saudi Arabia	0.11
Cote D'Ivoire	0.90	Nepal	0.07
Jordan	0.83	China	0.07
Thailand	0.71	Malaysia	0.07
Serbia	0.69	Japan	0.06
Sweden	0.64	Viet Nam	0.06
United States	0.63	Uganda	0.03
Norway	0.61	Poland	0.03
United Kingdom	0.56	Indonesia	0.02
Morocco	0.51	Colombia	0.02
Dominican Republic	0.50	Nigeria	0.01

Based on the data presented above, it may be concluded that of all the analyzed countries only the Republic of Korea won a disproportionately high number of gold medals in relation to the number of won silver and bronze medals. All other countries ranked from 1st to 10th place with respect to the number of medals won per one million residents have a higher number of silver and bronze medals in relation to gold medals. Table 4 shows the results of a non-parametric correlation analysis of the observed variables.

Table 4: Rank correlation matrix

	POPUL	TOTPTS
POPUL	1	0.46*
TOTPTS	0.46*	1

Legend: POPUL – total number of residents expressed in millions, TOTPTS – total number of points.

All the research conducted so far has greatly emphasized the fact that population size is an important factor in winning medals at sport competitions, considering the fact that a larger population size of a country increases the probability of potentially talented athletes. By analyzing the results of the applied correlation analysis shown in Table 4 it can be concluded that, according to the existing research of the issue at hand, and in relation to the set hypothesis, there is a statistically significant correlation between the success of countries at World Taekwondo Championships and population size, i.e., the number of residents. More precisely, it has been established that on the level of significance $P < 0.05$ there is a moderate (0.46) statistically relevant correlation between the success of countries at world championships and the population size of individual countries.

CONCLUSION

Based on the obtained results, a ranking list of the general success of countries according to the total number of points won at world championships from 1973 to 2013 was created. Moreover, based on the coefficient calculation of the relative success of countries (TOTPTS/POPUL) in relation to population size (*number of points per million residents*), the ranking list of the relative success of countries was created. The fact that there are 207 member countries of the World Taekwondo Federation and the analyzed data from 68 countries from 6 continents that win medals at world championships lead to the conclusion that taekwondo is a globally practiced sport, and that the Republic of Korea is without a doubt the most successful country according to both of the applied criteria. The reason behind the "outstanding" success of Korean athletes can, among other things, be found in the noticeable positive ratio of the gold medals won in relation to silver and bronze medals, relative to all other countries. By applying correlation analysis, it has been established that on the level of significance $P < 0.05$ there is a moderate (0.46) statistically significant correlation between the success of countries at world championships and population size (i.e., number of residents) of individual countries.

In order to make further, but scientifically based conclusions regarding the possible factors related to the result-based success of countries, it would probably be advantageous to analyze the data on the impact of the gross domestic product (GDP) in future research. In this sense, it would undoubtedly be of interest to apply different models of success evaluation, with additional emphasis on the trends in the result-based success depending on changes in

population size, economic power and similar variables within the analyzed time periods. It would also be useful to investigate, taking into consideration the qualification system, whether there are statistically significant differences between the success of countries at world championships and the Olympic Games, as well as if there are differences in the result-based success of countries from different continents.

BIBLIOGRAPHY

Ball, D.W. (1972). Olympic Games competition: structural correlates of national success, *International Journal of Comparative Sociology*, 15, 186-200.

Bernard, A., & Busse, M.R. (2004). Who wins the Olympic Games: Economic resources and medal totals, *Review of Economics and Statistics*, 86, 413-417.

Bian, X. (2005). Predicting Olympic Medal Counts: The Effects of Economic Development on Olympic Performance, *The Park Place Economist*, XIII, 37-44.

Grimes, A.R., Kelly, W.J., & Rubin, P.H. (1974). A socioeconomic model of national Olympic performance, *Social Science Quarterly*, 55, 777-82.

Johnson, D. K. N., & Ali, A. (2000). *Coming to play or coming to win: Participation and success at the Olympic Games*. Department of Economics, Wellesley College, Wellesley, MA.

Krishna, A., & Haglund, E. (2008). Why Do Some Countries Win More Olympic Medals? Lessons for Social Mobility and Poverty Reduction. *Economic & Political Weekly*, July, 12.

Levine, N. (1974). Why do countries win Olympic medals? Some structural correlates of Olympic Games success: 1972, *Sociology and Social Research*, 58, 353-360.

Moosa, I., & Smith, L. (2004). Economic development indicators as determinants of medal winning at the Sydney Olympics: an extreme bounds analysis. *Austral. Econ. Pap.* 43(3), 288-301.

Shughart, W. F., & Tollison, R.D. (1993). Going for the Gold: Property Rights and Athletic Effort in Transitional Economies, *Kyklos*, 46(2), 263-272.

Official page of the World Taekwondo Federation (www.wtf.org) (http://www.worldtaekwondofederation.net/images/Competition_Rules_2013-07-14_Puebla_GA.pdf)

Analysis of attitudes towards combat sports

Dino Belošević, Petra Mandić Jelaska¹, Antonio Perić

¹*Fitness Klub "Pink Panther", Kaštel Stari, Hrvatska*

ABSTRACT

Aim of this research was to analyze the attitudes towards combat sports of a group of people which can be characterized as being representative for the population of Croatia. In accordance with the aim of the study, sample (n=190) of adult respondents of varying age, gender, profession and sport preference from the Split-Dalmatia county area was used. Attitude towards combat sports and activities was measured with by using *Attitude towards combat sports scale*. The reliability of the measuring instrument was tested using the test-retest method on a subsample of $n_1=14$ examinees. Results indicate that respondents had a positive opinion of combat sports and activities in general. The results of the study could surely be used as an argument to encourage planning social activities that include combat sports in the Split-Dalmatia county and other areas.

INTRODUCTION

Sports are an integral part of everyday life for people all around the world. As such, they are an important segment of society and in this day and age they are seen as one of the fundamental social institutions, inseparable from politics, the economy, media, education, social structures, the institution of family or even religion. The social institution of 'sport' certainly relies heavily on the norms and values of the society of which it is a part of (Perasović & Bartoluci, 2007).

It is possible to have an opinion on any object, phenomenon or problem, which in turn makes it susceptible to assessment. Therefore, we can assess various attitudes towards sports (Pleša-Bosnar, Sertić & Ribičić, 2002). Consequently, there have been a lot of studies focused on researching attitudes

towards combat sports. For example, studies conducted among elementary school teachers point to the fact that female teachers are less inclined to like combat sports than their male counterparts (Busch et al., 1999). Another thing that stood out in these studies was the gender stereotype regarding attitudes towards combat sports in a sense that males responded more favorably to combat sports (Prot & Radić, 2010). Contrary to this, studies indicate that there are no differences in attitude towards combat sports based on gender or even age (Rogowska & Kuśnierz, 2013). Similarly, a study conducted among students in Poland showed no differences in attitude based on gender or age (Witkowski et al., 2012).

It is important to stress that there is an evident lack of scientific studies on attitudes towards combat sports conducted among the general population. Therefore, the aim of this study is to analyze the attitudes towards combat sports of a group of people which can be characterized as being representative for the population of Croatia.

METHODS

In accordance with the aim of the study, it was conducted on a sample (n=190) of adult respondents of varying age, gender, profession and sport preference from the Split-Dalmatia county area. Such a sample was chosen because of the tendency to obtain as generalizable results as possible.

The level of attitude towards combat sports and activities can be measured with reliable and valid one-dimensional measuring instrument *Attitude towards combat sports scale* SBS1 (Bosnar, Sertić & Prot, 1996). The questionnaire contains 20 statements regarding combat sports. Every statement is rated from 1 to 5 on the Likert scale, with 1 signifying a completely false statement and 5 signifying a completely accurate statement. The second part of the questionnaire contains the following segments: 1. Boxing, 2. Karate, 3. Taekwondo, 4. Wrestling, 5. Judo, 6. Kickboxing, 7. MMA. which respondent rate on the Likert scale from 1 to 7, with 1 signifying a completely negative attitude and 7 signifying a completely positive attitude. The reliability of the measuring instrument was tested using the test-retest method on a subsample of $n_1=14$ examinees. The correlation coefficient between the test and the retest was used as a measure of reliability.

The arithmetic mean and standard deviations for all the scale components were used as descriptive statistics parameters. The total score on the Attitude

towards combat sports scale (SBSS) was obtained by a simple summation of the answers from all the components, also taking into account the present scaled variables. In order to quantify the correspondence between people's preferences towards particular combat sports and activities, correlation coefficients were calculated and significance levels between preference variables for particular combat sports were added. Furthermore, the correlation between the total scores on the *Attitude towards combat sports scale* and the general attitude towards particular sports and activities scales was calculated. The data was processed using the Statistica 12.6. software. (StatSoft, Tulsa, USA). Type I error was set at 5%.

RESULTS AND DISCUSSION

The reliability test results indicate a relatively high reliability of the measuring instrument, which is evident from the correlation coefficient. More precisely, all the items had a test-retest correlation coefficient within $r=0,81$ to $1,00$ ($p<0,05$).

The descriptive statistics of the components in Table 1 show the average ratings respondents gave to particular statements.

Table 1. The descriptive statistics parameters of the measuring instrument: mean value (M), standard deviation (SD).

	M±SD
1. I wouldn't take up combat sports in any way, shape or form.	2,37±1,44
2. I simply can't understand people who enjoy fighting each other.	2,88±1,54
3. I hate boxing.	2,23±1,49
4. It's extremely satisfying to get the best of an opponent by using your own strength and skill.	3,81±1,21
5. Combat sports are no more dangerous than many other sports.	3,48±1,37
6. Combat sports should be banned because they advocate violence against people.	2,24±1,37
7. People who train karate are extremely aggressive.	1,97±1,17
8. I like to watch good contests from a variety of combat sports.	3,59±1,45
9. They shouldn't add more combat sports to the Olympics, but drop them from the competition.	2,05±1,30
10. Combat sports are brutal and boring.	2,20±1,33
11. I would never allow my child to take up combat sports.	2,16±1,32

12. I dream of becoming well-known in the combat sports circuit.	2,05±1,28
13. It's pleasing to see a well executed kick.	3,63±1,48
14. Fighting builds character.	3,44±1,29
15. If there were no combat sports, something would be missing from our civilization.	2,61±1,22
16. Combat sports don't appeal to me because a person might get injured.	2,70±1,49
17. Only a barbarian would choose to take up combat sports.	2,01±1,19
18. Combativeness is a noble trait of humankind.	3,78±1,12
19. There is nothing that can justify the savagery on display in combat sports.	2,62±1,33
20. There should be more combat sports on television.	3,27±1,33

It is evident from table 1 that the absolute value of the statements that reflect negatively on combat sports and activities is low because the respondents gave them low ratings. This study suggests that respondents do not share the prejudice that people who participate in combat sports are "savages". Statements such as: "*People who train karate are extremely aggressive*", "*Only a barbarian would choose to take up combat sports*" and "*They shouldn't add more combat sports to the Olympics, but drop them from the competition*" got the lowest ratings of all. There are studies which go against the opinion that the people who love combat sports are extremely aggressive (Daniels & Thornton, 1990; Daniels & Thornton, 1992). The following statement: "*I dream of becoming well-known in the combat sports circuit*" also got a low rating of 2,05, which suggests that the respondent sample is a diverse one and not a specific one that consists merely of people who professionally engage in combat sports. It is important to stress that the respondents on average have nothing against their children taking up combat sports.

The statements that speak positively of combat sports and activities have the highest average rating. It is clear that the respondents on average have a high regard of the skills used in combat sports and activities and see them as being useful in everyday life. Statements such as: "*It's extremely satisfying to get the best of an opponent by using your own strength and skill*", "*Combativeness is a noble trait of humankind*", received the highest average rating and speak of the competitive nature of the respondents and their relationship with combat sports and activities which satisfy their needs. The statement "*It's pleasing to see a well executed kick*" also got a very high average rating of 3.63 and has the third overall highest rating in the questionnaire, which suggests that combat

sports are held in high regard and are found to be esthetically appealing. The following statements were also rated very highly: *“I like to watch good contests from a variety of combat sports”* and *“Fighting builds character”*. Martial arts have been developing for centuries now and many studies suggest they exert a positive influence on a person’s character and develop positive moral modes of behavior (Twemlow et al., 2008, Hunlei , 2008).

Table 2 shows the arithmetic mean (M), minimum (Min) and maximum result (Max) and the standard deviation (SD) of the condensed result on the Attitude towards combat sports scale.

Table 2. Descriptive statistics parameters: Arithmetic mean (M), minimum result (Min), maximum result, (Max) and standard deviation (SD) of the Attitude towards combat sports scale from respondents from the Split-Dalmatia county.

Attitude towards combat sports scale	AM±SD	Min	Max
	70,23±25,35	20	100

By using simple summation and taking into account the scaled variables of the components, the relatively high average score of 70,23 was obtained. The maximum possible score of a 100 would denote a complete and absolute preference towards combat sports. The results show a relatively high, i.e. positive, attitude towards combat sports among the respondents. Furthermore, table 3 shows the descriptive statistics parameters for particular combat sports and activities preferences.

Table 3. Descriptive statistics parameters: arithmetic mean (M), standard deviation (SD) for combat sports and activities preferences.

	M±SD
Boxing	4,62±1,62
Karate	4,00±1,38
Taekwondo	3,93±1,39
Wrestling	3,70±1,50
Judo	4,04±1,46
Kickboxing	4,57±1,53
MMA	4,37±1,85

Table 3 shows that boxing has the highest average rating with 4,62. In order from the highest to the lowest average rating, boxing is followed by: Kickboxing, MMA (mixed martial arts), Judo, Karate, Taekwondo and Wrestling.

INVITED LECTURES
POZVANA PREDAVANJA

It is interesting to note that MMA has the highest standard deviation of 1,85 which suggests that even though the respondents have a fairly good opinion of the activity, the results are more dispersed. There is a relatively large number of respondents which gave MMA either a low or high rating. Although it is one of the oldest sports, wrestling got the lowest average rating. Kickboxing finds itself in second place with an average rating of 4,57, just behind Boxing with a rating of 4,62. On the other hand, in a similar study conducted on a specific group of respondents from the Faculty of Philosophy combat sports are perceived as brutal and the respondents are not attracted to the idea of finding themselves in close contact with their opponents (Gošnik, Sedar & Bunjevac, 2007).

Table 4 contains correlation coefficients between the sports and activities with regard to preferences.

Table 4. Correlation between preference variables towards particular combat sports

	Boxing	Karate	Taekwondo	Wrestling	Judo	Kickboxing
Karate	0,48*					
Taekwondo	0,33*	0,74*				
Wrestling	0,45	0,35	0,38			
Judo	0,24	0,38	0,45	0,58*		
Kickboxing	0,74*	0,41*	0,37*	0,24	0,23*	
MMA	0,69*	0,35*	0,38*	0,33	0,27	0,76*

*-statistically significant correlations ($p < 0,05$)

It is noticeable that boxing has a high correlation coefficient with kickboxing (0.74) and MMA (0,69). It is also evident that these are the three exact sports which were best ranked in the preference questionnaire. Kickboxing and boxing share the same technical-tactical features and are based on stand-up fighting, even though kicks are a prominent factor in kickboxing. MMA is greatly defined by techniques used in these two sports. Furthermore, karate only has a high correlation coefficient with taekwondo. Their technical-tactical structure is also extremely similar so these results are not surprising. Also, taekwondo has an insignificant correlation coefficient with judo. These two sports do not share technical-tactical elements, because one is a striking sport and the other is a grappling sport. However, both of these sports are performed while wearing a kimono. It is important to note that wrestling and judo have a significant correlation coefficient of 0.58, which is probably due to the fact

that both sports are based on direct contact and have the aim to physically overpower an opponent, pin him to the ground and control him. That fact is most likely the „differentia specifica“ that separates judo and wrestling from the other sports.

Table 5. Correlation coefficients for the total scores on the Attitude towards combat sports scale and the General attitude towards particular sports and activities scales

	Boxing	Karate	Taekwondo	Wrestling	Judo	Kickboxing	MMA
Total score on the Attitude scale	0,50*	0,30*	0,24*	0,24	0,22	0,47*	0,43*

*-statistically significant correlations ($p < 0,05$)

Table 5 shows that the highest and a statistically significant correlation coefficient for the total scores on the Attitude scale is shared between Boxing, Kickboxing and MMA. Among this group of respondents, these three sports got the best average preference rating. Also, they have many common aspects.

This leads to the conclusion that to these respondents the connection between the total scores on the Attitude scale is more prominent for boxing, kickboxing and MMA than for the other sports.

CONCLUSION

This research was an attempt to show and interpret the attitudes of a relatively diverse group of respondents towards a group of combat sports and activities. In line with the aim of the thesis, a sample of $n=190$ respondents was questioned using the measuring instrument known as the Attitude towards combat sports scale SBS1. Most of the respondents were from the Split-Dalmatia county, which should not diminish the possibility of generalizing the results. The attitude levels towards combat sports and activities determined by the measuring instrument were rated relatively highly. The respondents had a positive opinion of combat sports and activities in general.

The results of the study could surely be used as an argument to encourage planning social activities that include combat sports in the Split-Dalmatia county and other areas. It would certainly be of public interest that the preference indicators were taken into account and the results were used as a basis to instigate activities to which the respondents responded to favorably.

The study was limited by the sample and the relatively low number of respondents, and the same study should be conducted with a larger random

sample across the whole of Croatia. Therefore, larger and fully representative respondent samples should be used in future studies of this type so that a general insight into the people's attitude towards combat sports could be gained.

REFERENCES

Bosnar, K., Sertić, H., & Prot, F. (1996). Construction of the scale for assessing attitudes towards combat sports. Conference proceedings from the "5. summer school of physical education pedagogues of the Republic of Croatia". Findak, V., (ed.). Zagreb: Physical Education Pedagogues Federation, 73-75.

Busch, T., Bosnar, K., Sertić, H. & Prot, F. (1999). Attitudes towards combat sports among elementary school teachers. In Milanović, D. (ed.) *Kinesiology for the 21. century*, pp 126-128. Zagreb: Faculty of Physical Education of the University of Zagreb.

Daniels, K., & Thornton, E.W. (1990). An analysis of the relationship between hostility and training in the martial arts. *J Sport Sci* 8, 95-101.

Daniels, K., & Thornton, E.W. (1992). Length of training, hostility and the martial arts: A comparison with other sporting groups. *Brit J Sport Med* 2; 26 118-120.

Gošnik, J., Sedar, M., & Bunjevac, T. (2007). Preferences of male and female Faculty of Philosophy students towards sports activities, U: V. Findak (ed.). Conference proceedings from the 16. summer school of the kinesiologists of the Republic of Croatia, Poreč, 2007., "Anthropological, methodical, methodological and professional aspects of working in the fields of education, sports, sports recreation and kinesitherapy", Zagreb: Croatian Kinesiology Federation, pp 430 – 437.

Hunlei, L. (2008). Eastern martial arts and violence prevention. Reversing a stereotype. *Arch Budo* 4, 32-36.

Perasović, B., & Bartoluci, S. (2007). The sociology of sport in the context of Croatia, *Sociology and space*, 45, 105-119.

Pleša-Bosnar, V., Sertić, H., & Ribičić, G. (2002). Attitudes of male and female Police College students towards combat sports. U V. Findak (ed.) Conference proceedings from the "11. summer school of the kinesiologists of the Republic of Croatia". pp 164-167. Zagreb: Croatian Kinesiology Federation.

Radić, K., (2010). Attitudes of male and female Faculty of Kinesiology students towards combat sports (Diploma thesis). Zagreb: Faculty of Kinesiology.

Twemlow, S., Biggs, B., Nelson, T., Vernberg, E., & Fonagy, P. (2008). Effects of participation in martial arts – based antibullying program in elementary schools. *Psychol Schools 45*, 947-959.

Rogowska, A., & Kuśnierz, C. (2013). Determinants of the attitude towards combat sports and martial arts. *Journal of Combat Sports and Martial Arts 4*(2): 185-190.

Witkowski, K., Kuśnierz, C., & Cynarski, W.J. (2012). Polish students' knowledge and their attitudes towards martial arts and combat sports. *Ido Mov Cult 5-9*.

The differences in the selected indicators of the situational effectiveness between the A league Champions and the other clubs participating in UEFA Champions League 2014/15

Hrvoje Sivrić¹, Marko Erceg¹, Vujica Živković², Luka Pezelj¹

¹*Faculty of Kinesiology, University of Split, Croatia*

²*Faculty of Physical Culture, Skopje, Macedonia*

ABSTRACT

The insights into relevant factors significantly influencing competitive success raise numerous questions to be answered by coaches and researchers in the field of one of the most complex sports games - football. It can be stated that the efficiency/ success in football is determined by the level of success in performing both individual and collective tactics/ actions which are repeated during the game, and that it can be reflected in the indicators of the situational effectiveness. Thus, the main objective of this paper has been to determine whether there are differences in the selected indicators of situational effectiveness in the UEFA Champions League group stage in the season 2014/2015 between the best football clubs divided in "A league Champions (English Premier league, German Bundesliga, Spanish Primera, Italian Serie A and French Ligue 1)" and "the other clubs". The results, obtained by performing a discriminant analysis, show differences between "A League Champions" and "The other clubs", as well as that the groups are discriminated by effective short and crossfield passes. The "A League Champions" achieve more short and crossfield passes, which means that they have higher ball possession percentages, which provides them with the higher probability to win and play in the playoffs. Furthermore, the results show that the team in control of the midfield - the ball possession, wins the game.

Keywords: football, clubs, efficacy

UVOD

Spoznaje o relevantnim faktorima koji su značajno povezani sa igračkom i momčadskom učinkovitošću, a samim time i natjecateljskom uspješnošću pitanja su koja se nameću mnogim trenerima i istraživačima u području sporta, pa tako izuzetak nije ni nogometna igra. Nogomet je jedna od najkompleksnijih sportskih igara i može se reći da je uspješnost u nogometu određena razinom uspješnosti obavljanja individualnih i kolektivnih zadataka koji se ponavljaju tijekom igre.

Uspješnost u izvršavanju zadataka u igri može se prikazati i kroz pokazatelje situacijske učinkovitosti. U području nogometne igre iznimno je veliki broj istraživanja međutim, prema autoru dostupnim podacima, istraživanja u području situacijske učinkovitosti u nogometu nisu toliko česta. Bitno je za istaknuti da se u dosadašnjim istraživanjima smjer samog istraživanja kretao u području individualnih pokazatelja razlika između nogometaša, odnosno nisu se istraživale momčadski pokazatelji niti se išlo u cilju definiranja standardnih i nestandardnih pokazatelja situacijske učinkovitosti u nogometu. Tek Bloomfield (2005) navodi da je neophodno identificirati izvore varijabilnosti i standardizirati pristup i analizu podataka. Trninić (2006) navodi da su pokazatelji situacijske učinkovitosti tradicionalni način procjenjivanja individualne i timske izvedbe, koji oslikavaju samo djelomičnu uspješnost u igri. Nadalje Trninić (2006) tvrdi kako je situacijska učinkovitost djelomični pokazatelj stvarne kvalitete igrača i igre te da je određena individualnom i momčadskom razinom sportske forme, uigranošću ekipe te razinom integralne pripremljenosti igrača i cijele momčadi. S tim u vezi situacijska učinkovitost nije samo funkcija situacije i stvarne kvalitete igrača, već i taktike suprotstavljenih momčadi, odluka sudaca, utjecaja publike, funkcionalnih odnosa u ekipi (kvalitete suradnje), razine vjere u sustav igre i način treniranja te uloženog napora u igri obje momčadi. Od istraživanja koja su učinjena na pokazateljima situacijske učinkovitosti u momčadskom smislu može se istaknuti Szwarc (2008) koji navodi da rezultati pokazuju da momčad koja kontrolira posjed lopte pobjeđuje u igri kao i istraživanje na 16 utakmica Liga prvaka, Smajić, Molnar i Radoman (2008), gdje se navodi da rezultati pokazuju da su uspješni nogometni klubovi statistički učinkovitiji u aktivnostima s loptom koja im je omogućila sportsko postignuće. Trninić i Vukičević (2005) upućuju da su čimbenici koji određuju situacijsku učinkovitost igrača i momčadi slijedeći: stvarna kvaliteta igrača i igre, razina sportske forme, uigranost ekipe, integralna pripremljenost igrača i cijele momčadi, situacija, stvarna kvaliteta igrača, taktika suprotstavljenih momčadi, kvaliteta suradnje,

razina vjere u vlastiti sustav igre, način treniranja, suci, publika, ulože napor vlastite i protivničke momčadi.

U ovom radu ispitat će se i procijeniti, pomoću odabranih pokazatelja situacijske učinkovitosti, djelomična uspješnost u igri kod vrhunskih nogometnih klubova. Varijabilnost pokazatelja izvedbe pojedinih nogometaša i momčadi na vremenskom nizu utakmica iznimno su važni podaci koji se mogu koristiti za povećanje performansi i učinkovitosti u samoj igri. Neophodno je razvijati metode za objektivnije procjene stvarne kvalitete u igri, te definirati standardne i nestandardne pokazatelje situacijske učinkovitosti u nogometu.

Cilj ovog istraživanja, koristeći diskriminacijsku analizu, bio je ispitati postoje li razlike između vrhunskih nogometnih klubova podijeljenih u dvije grupe „Klubovi liga petice“ i „Klubovi ostali“ u odabranim pokazateljima situacijske učinkovitosti u grupnoj fazi UEFA Lige prvaka u sezoni 2014/15.

METODE RADA

Uzorak predstavlja 190 entiteta, gdje entitete predstavljaju 32 nogometna kluba koja su sudjelovala u grupnoj fazi natjecanja UEFA Lige prvaka, sezone 2014/15. Odigrano je ukupno 96 utakmica dok je u samom istraživanju obrađeno 95 utakmica. U svakoj utakmici svaka ekipa predstavlja jedan entitet. Izmjerena 32 nogometna kluba čini 16 „Klubova liga petice“ i 16 „Klubova ostali“. „Klubovi liga petice“ su klubovi koji pripadaju u skupinu od 5 najjačih europskih nogometnih liga koju čine Engleska Premier League, Francuska Ligue 1, Talijanska Serie A, Njemačka Bundesliga i Španjolska La Liga. Pokazatelje situacijske učinkovitosti sačinjavalo je 17 varijabli: postignuti golovi ekipe na utakmici (GOL), posjed lopte (POS), prijeđena udaljenost (PRE), udarci na gol u okvir (UDARCI-O), udarci na gol izvan okvira, (UDARCI-IO), blokirani udarci na gol (UDARCI-B), kornar (KOR), zaleđe (ZAL), žuti karton (ŽUT), crveni karton (CRV), napravljeni prekršaji (PRK), neuspjela dodavanja – duga (NDOD-D), neuspjela dodavanja srednja (NDOD-S), neuspjela dodavanja – kratka (NDOD-K), uspjela dodavanja – duga (UDOD-D), uspjela dodavanja – srednja (UDOD-S), uspjela dodavanja – kratka (UDOD-K). Svi rezultati dobiveni su na službenoj stranici UEFA Champions league. Metode obrade rezultata uključile su izračunavanje deskriptivnih statističkih parametara prema grupama aritmetička sredina (AS) i standardna devijacija (SD). Zatim je napravljena interkorelacija među odabranim pokazateljima situacijske učinkovitosti. Da bi se utvrdilo postoje li značajne razlike između dvije grupe napravljena je kanonička diskriminacijska

analiza između grupe „Klubovi lige petice“ i „Klubovi ostali“. U sklopu kanoničke diskriminacijske analize izračunat je koeficijent kanoničke diskriminacije, pozicije grupa na diskriminacijskoj funkciji, te korelacije manifestnih varijabli s diskriminacijskom funkcijom. Testiranje značajnosti koeficijenta kanoničke diskriminacije provedeno je Bartletovim Hi-kvadrat testom.

REZULTATI I RASPRAVA

Područje analize odabranih pokazatelja situacijske učinkovitosti podijeljeno na dvije grupe „Klubovi liga petice“ i „Klubovi ostali“, aritmetičke sredine i standardne devijacije prikazane su u tablici 1.

Tablica 1. Deskriptivni pokazatelji odabranih pokazatelja situacijske učinkovitosti, grupa „Klubovi liga petice“ i „Klubovi ostali“.

	AS _o	SD _o	AS _p	SD _p
GOL	1,10	1,39	1,80	1,55
POS	44,30	9,03	50,00	7,99
PRE	114136,00	4638,26	113983,60	5142,25
UDARCI-O	4,10	2,92	5,30	2,68
UDARCI-IO	4,70	2,70	5,50	2,75
UDARCI-B	3,20	2,12	3,70	2,74
KOR	4,30	2,26	5,10	2,70
ZAL	2,10	1,77	2,90	1,89
ŽUT	2,20	1,50	1,70	1,35
CRV	0,10	0,33	0,10	0,32
PRK	13,10	4,13	12,30	4,48
NDOD-D	12,60	5,90	12,90	5,28
NDOD-S	24,80	8,08	26,00	8,83
NDOD-K	17,80	9,01	18,90	8,95
UDOD-D	35,10	15,04	39,60	14,66
UDOD-S	226,10	80,75	291,70	108,84
UDOD-K	79,40	25,70	118,10	36,15

AS_o-aritmetička sredina grupa „Klubovi ostali“, SD_o-standardna devijacija grupa „Klubovi ostali“, AS_p-aritmetička sredina grupa „Klubovi liga petice“, SD_p-standardna devijacija grupa „Klubovi liga petice“

Iz tablice 1. vidljivo je da „Klubovi lige petice“ imaju veće prosječne vrijednosti u većini varijabli, tj. manje u obrnuto skaliranim varijablama. Najistaknutija razlika je u varijabli UDOD-K u kojoj je vidljivo da „Klubovi liga petice“ imaju četrdesetak uspješnih kratkih dodavanja više od ostalih klubova, kao i UDOD-S preko 60 uspješnih srednjih dodavanja više od ostalih klubova po utakmici. Zanimljivo je da na varijabli PRE „Klubovi liga petice“ imaju u prosjeku, uz zanemarivu razliku, jednak broj pretrčanih kilometara.

Tablica 2. Interkorelacija među odabranim pokazateljima situacijske učinkovitosti.

	1.	2.	3.	4.	5.	6.	7.	8.	9.	10.	11.	12.	13.	14.	15.	16.	17.
1.	1,00																
2.	0,33	1,00															
3.	0,05	-0,08	1,00														
4.	0,66	0,45	0,06	1,00													
5.	0,18	0,32	0,13	0,42	1,00												
6.	0,12	0,37	0,02	0,35	0,28	1,00											
7.	0,28	0,39	0,01	0,41	0,30	0,47	1,00										
8.	0,02	0,05	0,02	0,12	0,00	0,04	0,11	1,00									
9.	-0,31	-0,16	-0,17	-0,29	-0,16	-0,12	-0,20	0,04	1,00								
10.	-0,10	-0,04	-0,13	-0,09	-0,09	-0,09	-0,10	-0,08	0,25	1,00							
11.	-0,23	-0,13	-0,04	-0,28	-0,10	-0,15	-0,23	-0,10	0,40	0,17	1,00						
12.	-0,11	-0,09	0,24	-0,08	0,05	-0,09	-0,12	0,10	0,13	0,00	0,08	1,00					
13.	-0,01	0,20	0,28	0,03	0,09	0,18	0,10	-0,04	-0,01	0,06	0,03	0,44	1,00				
14.	-0,04	0,07	0,26	-0,02	0,00	0,14	0,06	-0,03	-0,09	0,12	0,00	0,26	0,62	1,00			
15.	0,39	0,69	-0,03	0,40	0,29	0,18	0,25	0,00	-0,24	-0,13	-0,22	0,01	0,06	-0,09	1,00		
16.	0,34	0,77	-0,06	0,44	0,21	0,38	0,31	-0,03	-0,32	-0,08	-0,39	-0,17	0,12	0,05	0,67	1,00	
17.	0,41	0,59	-0,04	0,45	0,23	0,29	0,29	0,06	-0,34	0,02	-0,38	-0,13	0,14	0,16	0,43	0,79	1,00

1.GOL, 2.POS, 3.PRE, 4.UDARCI-O, 5.UDARCI-IO, 6.UDARCI-B, 7.KOR, 8.ZAL, 9.ŽUT, 10.CRV, 11.PRK, 12.NDOD-D, 13.NDOD-S, 14.NDOD-K, 15.UDOD-D, 16.UDOD-S, 17.UDOD-K

Rezultati interkorelacija među odabranim pokazateljima situacijske učinkovitosti prikazani su u tablici 2. Najveću korelaciju s ostalim varijablama ima varijabla POS, koje je u visokoj korelaciji sa svim uspješnim dodavanjima. Najveća korelacija je s uspješnim srednjim dodavanjima ($r=0,77$), zatim uspješnim dugim dodavanjima ($r=0,69$) i uspješnim kratkim dodavanjima ($r=0,59$), što upućuje da su za duži posjed lopte u nogama nužna uspješna kontinuirana međusobna dodavanja, što je i u skladu s očekivanjima. Uspješna dodavanja su i među sobom u visokoj korelaciji; kratka-srednja ($r=0,79$), duga-srednja ($r=0,67$) i kratka-duga ($r=0,43$). Uspješna dodavanja su u srednje visokoj korelaciji i s udarcima u okvir ($r=0,40 - 0,45$). Ovaj podatak nas navodi na vjerojatni zaključak da uspješna dodavanja otvaraju mogućnost otvorenog i preciznijeg udarca na gol, a budući da je varijabla udarac u okvir u korelaciji s varijablom GOL $r=0,66$, očigledno da su uspješna kratka, srednja i duga dodavanja glavni faktor za realizaciju završnih akcija.

Tablica 3. Diskriminacijska analiza između grupe „Klubovi lige petice“ i grupe „Klubovi ostali“

Varijable	„Klubovi liga petice“	„Klubovi ostali“	DF
	N=16 AS±SD	N=16 AS±SD	
GOL	1,80±1,55	1,10±1,39	-0,29
POS	50±7,99	44,30±9,03	-0,42
PRE	113983,60±5142,25	114136±4638,26	0,01
UDARCI-O	5,30±2,68	4,10±2,92	-0,26
UDARCI-IO	5,50±2,75	4,70±2,7	-0,19
UDARCI-B	3,70±2,74	3,20±2,12	-0,13
KOR	5,10±2,70	4,30±2,26	-0,2
ZAL	2,90±1,89	2,10±1,77	-0,31
ŽUT	1,70±1,35	2,20±1,50	0,24
CRV	0,10±0,32	0,10±0,33	0,08
PRK	12,30±4,48	13,10±4,13	0,12
NDOD-D	12,90±5,28	12,60±5,90	-0,04
NDOD-S	26±8,83	24,80±8,08	-0,08
NDOD-K	18,90±8,95	17,80±9,1	-0,08
UDOD-D	39,60±14,66	35,10±15,04	-0,19
UDOD-S	291,70±108,84	226,10±80,75	-0,43
UDOD-K	118,10±36,15	79,40±25,70	-0,78
Centroidi	-0,78	0,78	CanR = 0,62
Wilks' lambda = 0,62	$\chi^2=86,22$	SS=17,00	p = 0,00

N–broj ispitanika, AS–aritmetička sredina, SD–standardna devijacija, DF–koeficijenti korelacije diskriminacijske funkcije i varijabli, CanR–koeficijent kanoničke korelacije, Wilks' lambda–koeficijent Wilksova lambda, χ^2 –testna vrijednost pri testiranju značajnosti diskriminacijske funkcije, SS–broj stupnjeva slobode: p–razina statističke značajnosti diskriminacijskog modela

Rezultati su obrađeni kanoničkom diskriminacijskom analizom i iz tablice 3. je vidljivo da koeficijent kanoničke diskriminacije iznosi $CR=0,62$ što nam pokazuje da razlika između grupe „Klubovi liga petice“ i grupe „Klubovi ostali“ po navedenim varijablama očito postoji s obzirom na situacijske parametre koji su izmjereni. Diskriminacijska funkcija značajno razlikuje grupe. Testiranje značajnosti navedenog koeficijenta provedeno je Bartletovim Hi-kvadrat testom, koji je statistički značajan uz pogrešku $p=0,00$. U tablici 3. prikazane su i aritmetičke sredine grupa na diskriminacijskoj funkciji. Vidljivo je da se grupa „Klubovi liga petice“ pozicionirala na negativan pol diskriminacijske funkcije, dok se grupa „Klubovi ostali“ pozicionirala na pozitivan pol. U tablici 3. također se vidi da sve varijable koje razlikuju grupe su na negativnom polu diskriminacijske funkcije, što nam govori da „Klubovi liga petice“ postižu veće rezultate na tim varijablama. Pojedinačno, razlici najviše pridonosi varijabla UDOD-K ($r=-0,78$) što je i u skladu sa navedenim istraživanjima. Kako nam je kurtosis pokazao veliku raspršenost ekipa na ovoj varijabli, pretpostavili smo da razlika znatno ovisi jesu li „Klubovi liga petice“ ili ne. Slijedeća varijabla koja najbolje diskriminira grupe jetakođer vezana za kontrolu lopte i to je UDOD-S($r=-0,43$). Varijabla POS također u zadovoljavajućoj mjeri doprinosi diskriminaciji grupa ($r=-0,42$), što je očito posljedica uspješnih kratkih i srednjih dodavanja. Prema osnovnim statističkim parametrima, „Klubovi liga petice“ u prosjeku oko 50% vremena kontroliraju loptu u posjedu, dok „Klubovi ostali“ kontroliraju u posjedu loptu oko 44% vremena. Dakle „Klubovi liga petice“ imaju više kratkih i srednjih uspješnih dodavanja, iz čega proizlazi da imaju duže vrijeme loptu u posjedu, što im omogućava veću vjerojatnost za pobjedu, a time i prolaz u doigravanje. Budući da su varijable POSJED, posljedica visokih rezultata na varijablama UDOD-S i UDOD-K, pretpostavljamo da su najvažniji parametri koji razlikuju „Klubove liga petice“ i „Klubove ostali“ uspješna kratka i srednja dodavanja. Naveden istraživački nalazi mogu se pronaći u istraživanju Szwarc (2008).

Zaključak

Osnovni statistički parametri ukazivali su da postoje razlike jer dobiveni rezultati pokazuju da „Klubovi lige petice“ imaju veće prosječne vrijednosti u većini varijabli, tj. manje u obrnuto skaliranim varijablama. Kanoničkom diskriminacijskom analizom potvrđeno je da postoje razlike između grupe „Klubovi liga petice“ i grupe „Klubovi ostali“ na temelju navedenih varijabli. Najvažniji parametri koji razlikuju grupesu uspješna kratka i srednja dodavanja

kojih „Klubovi liga petice“ imaju više. Iz toga proizlazi da imaju duže vrijeme loptu u posjedu što omogućava veću kontrolu igre te veću vjerojatnost za pobjedu, a time i prijelaz u doigravanje. Dobiveni rezultati pokazuju da momčad koja kontrolira vezni red-posjed lopte, pobjeđuje u nogometnoj igri. Ograničavajući faktori ovog istraživanja očituju se u činjenicama da je velik broj čimbenika koji određuju situacijsku učinkovitost te da postoji nedostatak strukture standardnih i nestandardnih pokazatelja situacijske učinkovitosti u nogometu. Informacije o tzv. „slijepim točkama“ u području istraživanja pokazatelja izvedbe (situacijske učinkovitosti) i stvarne kvalitete sporta trebale bi usmjeravati buduća istraživanja. Isti autor navodi da upravo „slijepe točke“ u navedenom području koje tek trebaju biti istraživane ili koja su neopravdano zanemarena trebaju biti smjernice za buduća istraživanja (metaanaliza).

LITERATURA

Bloomfield, J. R. (2005): Soccer: physical characteristics, physical demands of match-play and effective physical conditioning, The University of Hull.

Smajić, M., Molnar, S., Radoman, M. (2008): The differences between winning and defeated football teams while performing various activities with a ball, Sport scientific and practical aspects, International Scientific Journal of Kinesiology, Vol. 5 Issue 1&2: 7-12

Szwarc, A. (2008): The efficiency model of soccer players actions in cooperation with other team players at the FIFA World Cup, Human movement, vol. 9 (1), 56 - 61

Trninić S. (2006): Selekcija, priprema i vođenje košarkaša i momčadi. Sveučilište u Splitu, Split.

Trninić, S., Papić, V., Trninić, V. i Vukičević, D. (2008): Player selection procedures in team sports games, Acta Kinesiologica 2, 1:24-28

Trninić, S. (2015): Osobna komunikacija na doktorskom studiju Kineziologije, Kineziološkog fakulteta Split, Sveučilišta u Splitu.

UEFA Champions league statistics

<http://www.uefa.com/uefachampionsleague/season=2015/statistics/index.html> (2.2.2015.)

Funkcionalni profil mladih košarkaša

Ensar Abazović¹, Erol Kovačević², Marko Erceg¹, Elvir Zametica²

¹Faculty of Kinesiology, University of Split

²Faculty of Sport and Physical Education, University of Sarajevo

ABSTRACT

The number of articles that aimed to evaluate the functional capacities of athletes from the team sports, as opposed to the individual, is very small, and therefore, the aim of this paper is to present the value of aerobic and anaerobic capacities of junior basketball players, and therefore, make a functional profile of young players aged 16-18 years. Aerobic and anaerobic capacities of 10 junior basketball players (BH: 191,3 ± 8,3cm; BW: 83,7 ± 11,7kg) was analysed. In this group, VO₂max had a mean value of 55,79ml/kg/min, ATVO₂ 42,61ml/kg/min (76.4% VO₂max), MaxHR 186,9bpm. Average force generated during the Wingate test was 8,47W/kg, while the peak was 11,56W/kg. Fatigue index amounted to 49.6%. Taking into account the results of this study, and comparing them with the results of other studies, it is evident that there was no difference between the levels of functional abilities of young players who were involved in this study and junior basketball players which were analysed in the studies of other authors.

Keywords: Junior Basketball Players, Aerobic Capacity, Anaerobic Capacity, Fatigue Index

UVOD

Košarka je veoma dinamična igra u kojoj igrači moraju da se u kratkom vremenu kreću veoma intenzivno, obiluje kratkim sprintovima, čestom promjenom pravca i smjera kretanja, okretanja, fintiranja, hvatanja i dodavanja lopte, šutiranja i dr. (Drinkwater i sur., 2008), te se može okarakterizirati velikim zahtjevima za igračkom aktivnošću različitog karaktera po intenzitetu

i koordinacionoj složenosti, što od igrača traži često i maksimalno mišićno naprezanje u promjenjivim situacijama. Iako košarka nije primarno sport izdržljivosti visok nivo kardiorespiratornih funkcija je značajan, moglo bi se reći neophodan, kako bi igrači održali i izdržali visokointenzivne aktivnosti tijekom cijele utakmice (Drinkwater i sur., 2008). Visok tempo igre u oba smjera stvara potrebu za veoma napornim intenzivnim treniranjem, a sve, da bi se zadovoljili trenajni kriteriji za vrhunsku izvedbu (Trunić, 2007).

U funkcionalnom smislu nivo treniranosti ogleda se u nivou aerobne i anaerobne izdržljivosti. Anaerobni kapacitet podrazumijeva stvaranje energije u uslovima nedostatka kisika (hipoksije). Uglavnom se izražava kao ukupna produkcija energije tokom kratkih aktivnosti visokog intenziteta. Statistički promatrano, košarkaši djeluju maksimalnim intenzitetom u igri 40-58% u odnosu na ukupno učešće u igri. Od ukupnog vremena provedenog u igri, 26% vremena, puls se nalazi ispod 160/min, dok je ostalih 74% vremena on viši od 160/min (Trunić, 2007).

S druge strane aerobne funkcionalne sposobnosti mogu se definirati kao sposobnosti sustava za transport kisika da dopremi, sustava za iskorištavanje da u biokemijskim procesima za proizvodnju energije iskoristi kisik i sposobnosti radne muskulature da iskoristi kisik u procesu razgradnje hranjivih tvari, a sve to radi obavljanja mišićnog rada (Sekulić i Metikoš, 2007). Sudarov i Fratarić (2010) navode da je VO_2 max osnovna i integralna mjera aerobne sposobnosti koja ukazuje na nivo sposobnosti organizma da udahnuti zrak pretvori u energiju. Primarni cilj ove studije prikazati vrijednosti aerobnih i anaerobnih kapaciteta mladih košarkaša (juniori KK „Spars“).

METODE

Uzorak ispitanika

Ukupno 10 ispitanika igrača, juniora košarkaškog kluba „Spars“ iz Sarajeva je činilo uzorak. Juniori KK „Spars“, koji su podvrgnuti testiranju su prvaci juniorske lige Bosne i Hercegovine, te prvaci A2 lige Jug. Prosječna visina: $191,3 \pm 8,3$ cm, prosječna težina: $83,7 \pm 11,7$ kg. Obzirom da se radi o maloljetnim osobama, roditelji svih ispitanikasu pristali da se istraživanje izvrši.

Košarkaši koji igraju na višem nivou imaju konzistentnije rezultate (Hoare i War, 2000; Drinkwater i sur., 2007), te su zbog toga, u svrhu ovog istraživanja testirani prvaci juniorske lige Bosne i Hercegovine.

Uzorak varijabli

Varijable koje su analizirane u ovom istraživanju se mogu podijeliti u dvije grupe:

1. Aerobni kapacitet
2. Anaerobni kapacitet

Primijenjene varijable iz testa opterećenja

1. $VO_2\text{max}$ – maksimalni primitak kisika (ml/kg/min)
2. $ATVO_2$ – primitak kisika na anaerobnom pragu (ml/kg/min)*
3. MaxHR – najviša vrijednost srčane frekvencije (otkucaja/min)
4. ATHR – vrijednost srčane frekvencije na anaerobnom pragu (otkucaja/min)*

* Anaerobni prag je određen V-slope metodom (na temelju praćenja odnosa primitka kisika i izdahnutog ugljičnog dioksida, te promjena minutnog volumena disanja) (Walsh i Davis, 1990),

Nadalje, anaerobni kapacitet je procijenjen pomoću idućih varijabli:

1. PP – vršna vrijednost generirane sile tokom Wingate testa (W/kg)
2. AP – prosječna vrijednost generirane sile tokom Wingate testa (W/kg)
3. FI – index zamora tokom izvedbe Wingate testa (%) – prema formuli:
[[PP-LP(lowest power))/PP]*100

Ispitanici su testirani u laboratorijskim uvjetima prema Kavcic i sur. (2012). Važno je napomenuti da su korištene isključivo relativnevrijednosti, što se može primijetiti iz mjernih jedinica.

Protokol testiranja

Maksimalni primitak kisika ($VO_2\text{max}$) je izmjeren tokom testa koji podrazumijeva kontinuirano trčanje na pokretnoj traci (Gait Trainer™ 2, Biodex, Shirley, New York, USA). Svi ispitanici su bili upoznati sa protokolom u koji su uključeni. U svrhu procjene $VO_2\text{max}$ -a, korišten je standardizirani Bruceov (Bruce, 1971) protokol koji podrazumijeva postepeno povećanje brzine trčanja i nagiba trake svake tri minute. Test se prekida kada ispitanik da znak da nije u stanju održavati dostignutu brzinu pokretne trake. Primitak kisika je mjereno pomoću metaboličkog analizatora (Fitmate PRO, Cosmed, Rome, Italy). Opravdanost uporabe Bruce protokola je pronađena u studijama od Zhang i sur.

(1991) i Hamlin i sur., (2012) koji navode da su parametri aerobnog kapaciteta isti neovisno o ukupnom trajanju testa. Srčana frekvencija je mjerena tokom trajanja testa pomoću pulsmetra (RCX5, Polar, Oulu, Finland).

Kada su u pitanju anaerobne sposobnosti, iste su procijenjene Wingate testom. Cjelokupni protokol je izveden prema standardu (Inbar, Bar-Or i Skinner, 1996; Beneke i sur., 2002). Za izvođenje testa korišten je biciklergometar (Cycle ergometer, Model 864, Monark, Sweden) opremljen elektronskim mjernim uređajem.

Metode obrade podataka

Za sve varijable su izračunati standardni centralni i disperzivni parametri kao i mjere asimetrije i izduženosti distribucije. Obrada podataka je izvršena pomoću statističkog paketa SPSS 21 za Windows operativni sustav.

REZULTATI I DISKUSIJA

Analizirajući tabelu 1, u kojoj su predstavljeni centralni i disperzivni parametri, može se konstatirati da su rezultati svih varijabli normalno distribuirani.

Tabela 1. Centralni i disperzivni parametri, te parametri asimetrije i izduženosti distribucije za sve varijable

Descriptive statistic						
	Mini- mum	Maxi- mum	Mean	Std. Devia- tion	Skew- ness	Kur- tosis
VO ₂ max	44.2	60.3	55.79	4.77	-1.69	3.67
ATVO ₂ max	36.9	52.7	42.61	4.98	.96	.59
MaxHR	168	197	186.9	8.37	-1.29	2.09
ATHR	155	182	168.9	9.50	-.25	-1.29
PP	8.82	13.53	11.56	1.52	-.28	-.51
AP	7.24	10.05	8.47	.86	.53	-.53
FI	32.92	67.39	49.60	10.32	-.196	.18

Obzirom da je primarni cilj ove studije prikazati rezultate mladih košarkaša Profili seniorskog uzrasta neće biti uključeni u raspravu. Pored navedenog, potrebno je naglasiti da, zbog promjena u pravilima košarkaške igre u 2000. godini, koja su dodatno utjecala na povećanje fiziološkog opterećenja igrača

tijekom košarkaške utakmice, istraživanja funkcionalnog stanja košarkaša, prije ove godine, nisu relevantna, te neće biti uključena u raspravu.

Rezultati koji se odnose na VO_2 max (tabela 1), kod analizirane skupine igrača imaju srednju vrijednost od 55,79ml/kg/min. Nadalje, prosječna vrijednost u varijabli primitak kisika na anaerobnom pragu $ATVO_2$ iznosi 42,61ml/kg/min, odnosno, 76,4% od maksimalnog primitka kisika. Pored ove dvije varijable, uočljivo je da je u varijabli MaxHR zabilježena prosječna vrijednost od 186,9/min., dok, rezultati varijabli koje se odnose na anaerobni prag pokazuju prosječnu vrijednost od 168,9/min., odnosno, procentualno, na 90% od maksimalnog pulsa u minuti se nalazi anaerobni prag.

Đelić i sur. (2005) su na uzorku ($n=12$; $16\pm 0,2$ godina) juniora dobio prosječnu vrijednost maksimalnog primitka kisika od $60,2\pm 1,4$ ml/kg/min, te maksimalni zabilježeni puls od $193,7\pm 1,8$ bpm. Slične rezultate su zabilježili Castagna i sur u studijama (2007) i (2008). Oni su na uzorku od 16 i 18 juniora ($16,8\pm 1,2$ godine), u sezonama u kojima su pobijedili na regionalnom košarkaškom prvenstvu, zabilježili prosječnu vrijednost maksimalnog primitka kisika od $59,6\pm 6,9$ ml/kg/min, odnosno $59,5\pm 7,9$ ml/kg/min. Prem da su u ova dva istraživanja zabilježeni nešto bolji rezultati u odnosu na rezultate ove studije, evidentno je da su razlike u svim parametrima funkcionalnih sposobnosti unutar 10 %, te nije moguće sasvim pouzdano tvrditi što je uzrok tim razlikama. Pored razlike u kvalitetu lige iz koje dolaze ispitanici prethodnih studija, one mogu biti uvjetovane i trenutkom u kome su izmjerene varijable funkcionalnih kapaciteta, naime u ovoj studiji ispitanici su testirani unutar takmičarskog perioda, što može rezultirati nešto nižim rezultatima ako se u obzir uzme umor igrača i motivacija za testiranje u momentu kad igraju takmičarske utakmice.

Apostolidis i sur. (2004), zabilježili su nešto niže rezultate od rezultata ove studije. U njihovoj studiji (Funkcionalni profil juniorskih reprezentativca Grčke uzrasta $18\pm 0,5$ godina) zabilježena je vrijednost maksimalnog primitka kisika od $51,7\pm 4,8$ ml/kg/min, dok je primitak kisika na anaerobnom pragu iznosio $77,6\pm 7\%$ od maksimalnog primitka kisika. Slične rezultate su dobili i Abbasian i sur. (2012), na uzorku od 45 košarkaša juniora uzrasta $16,46\pm 0,37$ godina (nasumično izabranih iz nacionalne juniorske lige) sa prosječnom vrijednosti maksimalnog primitka kisika od $51,53\pm 4,46$ ml/kg/min. Također, Stojanović i sur. (2007) su na ($n=26$) košarkaša juniora zabilježili nižu vrijednost maksimalnog primitka kisika $53,8\pm 5,5$ ml/kg/min, ali nešto višu kod primitka na anaerobnom pragu $46,3\pm 6,1$ ml/kg/min.

Kada su u pitanju anaerobni kapaciteti, dosadašnja istraživanja su daleko oskudnija po pitanju rezultata koji ukazuju na nivo istih. Iako se košarka smatra za primarno anaerobni sport (Ostojić i sur., 2006), interesantna je činjenica da je daleko manji broj istraživanja, ne samo na ovom uzorku, koji se bavio ovom problematikom. Stoga, rezultati Wingate testa će biti uspoređeni sa nešto manje studija, u koje, baš kao i u prethodnom dijelu teksta, su uključeni isključivo košarkaši juniori.

U ovoj studiji, prosječna vršna vrijednost generirane sile tokom Wingate testa iznosi 11,56W/kg, dok je prosječna vrijednost ukupno generirane sile tokom Wingate testa 8,47W/kg. Nadalje, indeks zamora tokom izvedbe Wingate testa, kod ispitanika uključenih u ovu studiju, je iznosi 49,6%.

Prethodno spomenuti Apostolidis i sur. (2004) navode je da prosječna vršna vrijednost generirane sile tokom Wingate testa iznosila $10,7 \pm 1,3$ W/kg, dok je prosječna vrijednost ukupno generirane sile tokom Wingate testa iznosila $8 \pm 0,7$ W/kg. Ukupno generirana sila tokom Wingate testa u istraživanju Stojanović i sur. (2007), iznosila je $6,3 \pm 1$ W/kg.

Nešto veća prosječna vršna vrijednost generirane sile tokom Wingate testa $14,1 \pm 1,4$ W/kg, prosječna vrijednost ukupno generirane sile $9,5 \pm 1$ W/kg, te indeks zamora tokom izvedbe testa $56 \pm 7,6\%$, zabilježena je u studiji (Hoffman i sur., 2000) na uzorku imala 9 članova Izraelske juniorske košarkaške reprezentacije.

ZAKLJUČAK

Uzimajući u obzir rezultate ove studije, te komparirajući ih sa rezultatima prethodnih studija uočljivo je da su funkcionalne sposobnosti mladih košarkaša iz ove studije na razini drugih juniorskih košarkaških selekcija koji su analizirani u studijama drugih autora, a koji koji su uglavnom uključivali reprezentativce različitih nacionalnih selekcija. Može se zaključiti da testirani uzorak ispitanika posjeduje visoku razinu funkcionalnih sposobnosti što je u skladu sa prosjekom elitnih igrača Evropskog nivoa. S ciljem objektivnijeg utvrđivanja stanja funkcionalnih sposobnosti ubudućim istraživanjima sličnog karaktera trebalo bi uzeti u obzir veći uzorak ispitanika što bi se postiglo uključivanjem većeg broja klubova iz nacionalne lige. Također, kako bi se dobila objektivnija slika prosječnog funkcionalnog profila košarkaša juniora potrebno je utvrditi razliku između različitih kvalitativnih razina između klubova unutar nacionalne lige, između igrača ligaške razine sa igračima reprezentativne razine, tu u konačnici razlike između igrača reprezentativnih selekcija različitog kvalitete.

LITERATURA

Abbasian, S., Golzar, S., Onvani, V., & Sargazi, L. (2012). The predict of RAST Test from WANT test in Elite Athletes. *Res J Recent Sci.* 1(3):72-5

Apostolidis, N., Nassis, G.P., Bolatoglou, T., & Geladas, N.D. (2004). Physiological and technical characteristics of elite young basketball players. *J Sports Med Phys Fitness.* 44(2):157-63.

Beneke, R., Pollmann, C., Bleifi, K., Leithauser, R.M., & Hutler, M. (2002). How anaerobic is the Wingate anaerobic test for humans. *Eur J Appl Phys.* 87.388-92.

Bruce, R.A. (1971). Exercise testing of patients with coronary heart disease. *Ann Clin Res.*3:323-30.

Castagna, C., Abt, G., Manzi, V., Annino, G., Padua, E., & D'Ottavio, S. (2008). Effect of recovery mode on repeated sprint ability in young basketball players. *J Strength Cond Res.* 22(3):923-9.

Castagna, C., Manzi, V., D'Ottavio, S., Annino, G., Padua, E., & Bishop, D. (2007). Relation between maximal aerobic power and the ability to repeat sprints in young basketball players. *J Strength Cond Res.* 21(4):1172-6.

Drinkwater, E.J., Hopkins, W.G., McKenna, M.J., Hunt, P.H., & Pyne, D.B. (2007). Modelling age and secular differences in fitness between basketball players. *J Sports Sci.* 25(8):869-78.

Drinkwater, E.J., Pyne, D.B., & McKenna, M.J. (2008). Design and Interpretation of Anthropometric and Fitness Testing of Basketball Players. *Sports Med.* 38(7):565-78.

Đelić, M., Suzić, J., Mazić, S., Mitrović, D. (2005). Aerobic capacity in young basketball players. 10th Annual Congress of the ECSS.

Hamlin, M.J., Draper, N., Blackwell, G., Shearman, J.P., & Kimber, N.E. (2012). Determination of maximal oxygen uptake using the Bruce or a novel athlete-led protocol in a mixed population. *Journal of Human Kinetics.* 31:97-104.

Hoare, D.G., & Warr, C.R. (2000). Predicting success in junior elite basketball players: the contribution of anthropometric and physiological attributes. *J Sci Med Sport.* 3(4):391-405.

Hoffman, J.R., Epstein, S., Einbinder, M., & Weinstein, Y. (2000). A Comparison Between the Wingate Anaerobic Power Test to Both Vertical Jump and Line Drill Tests in Basketball Players. *J Strength Cond Res.* 14(3):261-4.

Inbar, O., Bar-Or, O., & Skinner, J.S. (1996). The Wingate anaerobic test. Champaign (IL): Human Kinetics.

Kavcic, I., Milic, R., Jourkesh, M., Ostojić, S.M., & Ozkol, M.Z. (2012). Comparative study of measured and predicted vo2max during a multi-stage fitness test with junior soccer players. *Kinesiology*. 44(1):18-23.

Ostojić, S.M., Mazić, S., & Dikić, N. (2006). Profiling in basketball: physical and physiological characteristics of elite players. *J Strength Cond Res*. 20:740-4.

Sekulić, D., & Metikoš, D. (2007). Struktura i kineziološke transformacije funkcionalnih sposobnosti. U: D. Sekulić i D. Metikoš (ur.). *Osnove transformacijskih postupaka u kineziologiji*, str. 127-154. Split: Sveučilište u Splitu. Fakultet prirodoslovno-matematičkih znanosti i kineziologije.

Stojanović, M.D., Stojanović, M.V., Sergej Ostojić, S.M., & Fratrić, F. (2007). Is the maximal oxygen consumption single best predictor of shuttle-run test?. *Serb J Sports Sci*. 1(2):67-73.

Sudarov, N., & Fratrić, F. (2010). *Dijagnostika treniranosti sportista*. Novi Sad: Pokrajinski zavod za sport.

Trunić, N. (2007). *Trening mladih košarkaša različitih uzrasnih kategorija*. Visoka škola za sport. Beograd.

Walsh, S.D., Davis, J.A. (1990). Noninvasive lactate threshold detection using the modified V-Slope method with non-breath-by-breath data. *Med Sci Sports Exerc*. 22:S56

Zhang, Y., Johnson, M.C., Chow, N., & Wasserman, K. (1991). Effect of exercise testing protocol on parameters of aerobic function. *Med Sci Sports Exerc*. 23(5):625-30.

Differences between the elite and sub-elite athletes in kinematic and dynamic parameters of sprint - start

Milan Čoh¹, Milan Žvan¹, Stanislav Peharec², Petar Bačić²

¹Faculty of Sport, University of Ljubljana, Ljubljana, Slovenia

²Polyclinic for Physical Medicine and Rehabilitation "Peharec", Pula, Croatia

ABSTRACT

The purpose of the study was to determine differences between the elite and sub-elite athletes in some kinematic and dynamic parameters of sprint start, which represents the first segment of sprinting velocity. The study included 12 athletes, who were divided in two groups according to the 60 and 100- metre time criterion. System with 9 Smart-e 600 cameras was used for 3-D kinematic analysis. Dynamic parameters were determined with the help of bipedal tensiometric force plates with starting blocks installed on them. Differences between the athletes were calculated with the use of t-test for independent samples. The results revealed statistically significant differences between the measured subjects in seven kinematic and seven dynamic parameters of sprint start. The most important noticed kinematic generators of differences between the elite and sub-elite athletes were: pre-motor reaction time, total reaction time, block velocity, duration of leaving the rear starting block, duration of leaving the front starting block, length of first step and length of second step. In the dimension of sprint start dynamics, the athletes differentiated in the absolute force on the rear starting block, maximum vertical force on the rear starting block, time needed to generate the maximum force on the front starting block, the impulse of force on the front starting block and the absolute impulse on the front and rear starting blocks.

Key words: sprinters, sprint start, biomechanics.

INTRODUCTION

In sprint events, the sprint start is one of the crucial factors of competition success. According to the studies (Guissard and Hainaut, 1992; Harland and Steele, 1997; Hunter et al., 2004), the efficiency of realisation of sprint start depends mainly on the block positioning, position of body centre of gravity (BCG) in "set" position, block time, impulse of force on the front and rear starting blocks and block velocity, which continues into block acceleration. All these factors depend on specific motor abilities, energetic processes, morphological characteristics and central processes of motor regulation. Mero, Luhtanen and Komi (1983) have in their study found that block velocity is strongly correlated with horizontal and vertical force created on the front and rear starting blocks. Block positioning of both blocks, position of the body in "set" position has to ensure that the body centre of gravity (BCG) is at a height between 54 cm – 75 cm, whereas the horizontal projection of BCG has to be at the distance between 28 cm - 30 cm from starting line (Harland & Steele, 1997). Optimal correlation of start and block acceleration represents a specific motor problem, where an athlete has to integrate time and spatial acyclic movement into a cyclic one (Harland and Steele 1997; Ozsu, 2014). The purpose of the study was to determine the differences in kinematic and dynamic parameters of sprint start between the elite and sub-elite athletes. Hypothesis was set that the quality of athletes in kinematic and dynamic variables of start represents the generators of differences. The results of the study will help the understanding of biophysical starting mechanisms, which will then lead to the development of suitable training methods and tools for improvement of the quality of sprint start in athletes.

METHODS

The experiment included 12 best Slovenian sprinters (average age 22.4 ± 3.4 years, average body height 177.6 ± 6.9 cm, average body weight 74.9 ± 5.2 kg) with the average personal best results in 60-metre sprint at 6.93 ± 0.12 s (with the best result 6.65 s) and in 100-metre sprint at 10.82 ± 0.25 s (the best result 10.39 s). Concurring to the aims of the study, the athletes were divided in two groups, where the criterion for selection into either elite or sub-elite group was the result at an official competition in a 60 or 100-metre sprint event. Measurements of sprint starts were carried out in a biomechanical

laboratory of Polyclinic for physical medicine and rehabilitation »Peharec« in Pula, Croatia. The positioning of starting blocks was left individually to every athlete. System of 8 CCD cameras (SMART-e 600, BTS Bioengineering) with a 200 Hz frequency. Dynamic sprint start parameters were determined with the help of two independent force plates (Kistler Type 9286A), frequency 800 Hz, where two starting blocks were installed (see Figure 1). Data were statistically analysed with the use of SPSS for Windows 15.0 programme. In addition to basic statistical parameters of variables, the differences between the two groups of athletes were calculated with the use of t-test for independent samples. Differences were accepted at a 5% risk level ($p < 0.05$).

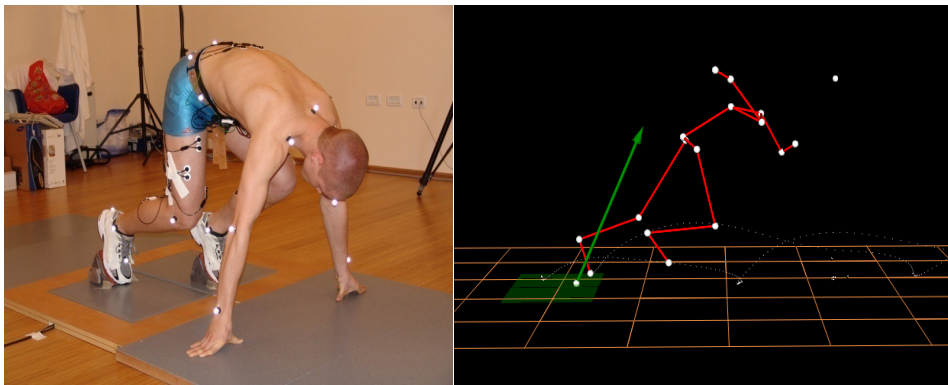

Figure 1: Measuring procedure of dynamic and kinematic variables in sprint start

RESULTS

In relation to the 100-metre sprint event results, the athletes significantly differentiated in eight kinematic parameters of sprint start (see Table 1): reaction time – premotor time, total reaction time (time from starting signal to the last contact with starting blocks), block velocity, time of the last contact of feet in front and rear starting blocks, the length of first step and block acceleration. According to the group of dynamic parameters of sprint start (see Table 2), the elite and sub-elite athletes differentiate in nine parameters: maximal horizontal and vertical force on the front starting block, maximal vertical force on the rear starting block, time of force acting on the front starting block, the impulse of force on the front starting block and in total impulse of force on both starting blocks.

Table 1: Kinematic parameters of sprint-start

Parameter	Unit	ELITE ATHLETES (6)		SUB-ELITE ATHLETES (6)	
		Mean	SD	Mean	SD
Reaction time – premotor time	ms	121 **	11.33	131	16.53
Block velocity	ms ⁻¹	3.83 **	0.17	3.16	0.19
Total block reaction time	ms	453 *	24.62	436	18.83
Reaction time - front block	ms	332 *	28.73	305	24.35
Reaction time – rear block	ms	162 *	9.47	149	12.40
Step one / length	m	1.30 *	0.51	1.06	0.60
Step two / length	m	1.03 *	0.12	0.98	0.33

* Significantly different at $p \leq 0.05$

** Significantly different at $p \leq 0.01$

Table 2: Dynamic parameters of sprint-start

Parameter	Unit	ELITE ATHLETES (6)		SUB-ELITE ATHLETES (6)	
		Mean	SD	Mean	SD
Total force / rear block	N	913 *	89.23	771	55.09
Maximal force / front block – horizontal	N	461 **	51.05	398	56.73
Maximal force / front block - vertical	N	1019 *	69.99	978	43.12
Maximal force / rear block - vertical	N	795 **	91.29	645	41.55
Time to peak force / front block	ms	262 **	22.11	242	15.22
Force impulse of front block	Ns	221.3*	15.8	178.3	13.1
Force impulse - total	Ns	294.3*	21.1	269.5	17.9

* Significantly different at $p \leq 0.05$

** Significantly different at $p \leq 0.01$

DISCUSSION AND CONCLUSIONS

The reaction - premotor time (RT), which is defined with a time interval between the starting signal and the activation of muscles applying the horizontal (pressure) force on the starting block, exceeding the 10% of maximal force (Mero and Komi, 1990, Mero, Komi and Gregor 1992). Premotor reaction time is statistically significantly shorter in elite athletes (121 ± 11 ms) in comparison with

the sub-elite athletes (131 ± 16 ms) - see Table 1. The same could not be found for the total block reaction time, which is defined with premotor reaction time and the time of leaving the front and rear starting blocks. Elite athletes have significantly longer total block reaction time. The difference between the elite and sub-elite groups was revealed at 17 ms. Time spent in front-rear starting block, which is defined with the start of production force on the starting block (10% of maximal horizontal force) to the moment the foot leaves the front-rear starting blocks (force = 0 N). The time of action in the front block is statistically significantly shorter in the sub-elite group of athletes (sub-elite = 305 ± 24 , elite = 332 ± 29 ms). Similarly, the sub-elite group of athletes had significantly shorter time of force action on the rear starting block

Longer reaction time allows the elite athletes to develop larger total block force on the front and rear starting blocks (see Table 2). The difference in the total force on the front starting block was noticed at 31 N yet it does not carry statistical significance. In contrast, the total force on the rear starting block is statistically significant; in the group of the elite athletes the difference between the total block force on the front and rear starting block is 17.3%, whereas the difference in the same parameter in the group of sub-elite athletes was measured at 28.1%. It can be concluded that better athletes develop more even force on both starting blocks. The impulse of force - block force (Impulse Ns = $F \times t$), which is mathematically equal to the total area under the force - time curve, is one of the most significant criterion of the efficient start (Harland and Steele, 1997; Gutierrez- Davila et al., 2006; Slawinski et al., 2010). The impulse of force is larger on the front than rear block, understandable as the front leg spends twice as much time on the block as the rear leg. Elite athletes develop statistically significantly larger impulse of force on the front block, compared to the group of sub-elite athletes (recorded difference = 24.8 N.s). Total impulse on both starting blocks thus significantly differentiates two groups of athletes. In the group of elite athletes the total impulse was measured at 294.3 ± 21.1 Ns, whereas in the group of sub-elite athletes it was 269.5 ± 17.9 Ns. Larger impulse of force on the front starting block generates larger block velocity (Harland and Steele, 1997). In order to generate the impulse of force, the largest part is down to the agonists and antagonists of ankle joint, which ensure the necessary stiffness of this segment. The key role in this process is in the motor programme joint stiffness regulation, which controls and synchronises the

work of flexors and extensors of the foot in take-off action from the starting block (Sale et al., 1983; Mero and Komi 1990; Guissard and Hainaut, 1992).

Start velocity is a product of optimal set position, production of force on front and rear starting block and high degree of automatism of start motor pattern (Mero and Komi, 1990; Slawinski et al., 2010). Start velocity is defined with the speed of leaving the front starting block; this parameter significantly differentiates elite and sub-elite athletes. The values of start velocity in the group of elite athletes were measured at $3.83 \pm 0.17 \text{ m}\cdot\text{s}^{-1}$ and in sub-elite at $3.16 \pm 0.19 \text{ m}\cdot\text{s}^{-1}$. The important criteria of start acceleration are the lengths of first two steps and their contact times. From the biomechanical aspect, the relationship between the length of step and ground contact time is changing. With the progressive increase in the length of step, the ground contact times are getting shorter. The speed is generated mainly by these two parameters (Mero and Komi, 1990; Guissard and Hainaut, Slawinski et al., 2010). In the group of elite athletes, ground contact times vary between 160 ms and 184 ms (Mero and Komi, 1990; Mero, Komi and Gregor 1992; Hunter et al., 2005). No significant differences were found in the ground contact times of first two steps in the athletes from the chosen sample. Elite athletes have generally shorter contact times in the first two steps, yet they are statistically not significant

Sprint-start is a very important element of sprinting dynamics. Its contribution to the final result in a 100-metre run is somewhere between 8 to 10%. The present study revealed that better athletes possess better quality of start in some kinematic and dynamic parameters. The differences were shown mostly in reaction times, block velocity, the magnitude of force production on the front and rear starting blocks, in larger total and partial impulse of force on starting blocks, in the time interval needed for the realisation of maximal force on the front block and in better transition from start into starting acceleration. Study was carried out on the best Slovenian athletes and with the use of latest diagnostic technology. On the basis of acquired information, the training process of sprinters will be easier to monitor and plan. A prerequisite for a good result in a 100-metre sprint event is a stable and efficient motor pattern of sprint start. Insufficient starting technique is often a cause of disqualification of the athlete in accordance with the latest rules. Optimisation of motor pattern is a long-term process, which can be successful only when its key biomechanical parameters and mechanisms are understood.

REFERENCES

Guissard, N. & Hainaut, K. (1992). EMG and mechanical changes during sprint start at different front block obliquities. *Medicine and Science in Sport and Exercise*, 24 (11), 1257-1263.

Gutierrez-Davila, M., Dapena, J. & Campos J. (2006). The Effect Muscular Pre-Tensing on the Sprint Start. *Journal of Applied Biomechanics*, 22, 194-201.

Harland, M. & Steele, J. (1997). Biomechanics of the Sprint Start. *Sports Medicine*, 23 (1), 11-20.

Hunter, J., Marshall, R. & McNair, P. (2004) Interaction of Step Length and Step Rate during Sprint Running. *Medicine and Science in Sport and Exercises*, 36 (2), 261-271.

Mero, A. & Komi, P. (1990). Reaction time and electromyographic activity during a sprint start. *European Journal of Applied Physiology*, 61, 73-80. Mero, A., Luhtanen, P. & Komi, P. (1983). A biomechanical study of the sprint start. *Scandinavian Journal of Sports Science*, 5 (1), 20-28.

Mero, A., Komi, P. & Gregor, R. (1992). Biomechanics of Sprint Running. *Sport Medicine* 13 (6), 376-392.

Ozsü, I. (2014). Biomechanical structure of sprint start and effect of biological feedback methods on sprint start performance. *Turkish Journal of Sport and Exercise*, 16 (1), 72-79.

Slawinski, J., Bonnefoy, A., Leveque, M., Ontanon, G. & Cheze, L. (2010). Kinematic and Kinetic Comparison of Elite and Well-Trained Sprinters During Sprint Start. *Journal of Strength and Conditioning Research*, 24 (4), 896-905.

Utjecaj antropometrijskih karakteristika na uspješnost plivanja kraul tehnikom kod vrhunskih hrvatskih plivača

Renata Pavić¹, Pero Kuterovac²

¹Kineziološki fakultet, Sveučilište u Splitu, Hrvatska

²Hrvatski Plivački Savez, Zagreb, Hrvatska

ABSTRACT

The primary goal of this research is to establish relationships and influences of anthropometry, with success freestyle swimming technique based on relationships and results crawl technique of top swimmers. Measurements were carried out on a sample of 43 categorized top swimmers from all over Croatia. Selection criteria were categorized swimmers, top athletes of first, second and third category according to the Croatian Olympic Committee criteria. All measured swimmers are members of the national swimming team. Respondents were male, age (mean = 21.41, s = 3.67), medically controlled and clinically healthy. Measurements were carried out in the Diagnostic Centre, Faculty of Kinesiology, SWC pool "Mladost" and the gym in the same center. Anthropometric space is represented by the tests that are an integral part of the IBP (International Biological Program), with a total of 27 measured variables. The results obtained measuring the subjects were analyzed in the program "Statistica for Windows 10.0." Anthropometric characteristics showed a large and significant impact on achieving superior crawl technique results. A set of tests covering anthropometric area that make 27 variables which, with 86%, determine success of crawl technique. Only 4 variables show a statistically significant effect on the value of freestyle swimming technique. After analysis it is possible to conclude that swimmers with greater sitting height, lower body height and smaller hand wrist diameter, thigh girth and percentage of body fat, but higher crystal suprailium skin folds can achieve better results in freestyle swimming technique. These results suggest the need of monitoring the status of anthropological crawl swimmers in these stated anthropometric characteristics, especially those that can affect the training process (% of body weight, skin folds and girths), while in the selection process monitoring longitudinal dimensionality of the skeleton is needed.

Key words: swimming, freestyle, anthropometry, swimming coaches.

UVOD

Područje kineziološke znanosti interdisciplinarno je i uz samosvojne činitelje, zadire u područje istraživanja ostalih znanstvenih disciplina koje objašnjavaju probleme antropometrije, bio-mehanike, fiziologije, psihologije, sociologije te njihov utjecaj na krajnji rezultat, vrhunski sportski cilj. Relacije između morfoloških te motoričkih karakteristika predmet su mnogih istraživanja i znanstvenih oprečnosti, a kako se plivačka aktivnost odvija u vodenom mediju i različitim tehnikama, time se taj prostor može osjetno zakomplicirati. Jedan od osnovnih problema koji se postavlja pred sportske djelatnike svih sportskih grana, pa tako i plivanja, jest izrada modela, to jest standarda prema kojima bi se plivači trebali selekcionirati. Budući da u plivanju postoje 4 plivačke tehnike jasno je da za svaku od njih treba izraditi poseban model, i to s obzirom na spol, dob i disciplinu. Težnja je autora da pridolesu rješavanju postojeće problematike utvrđivanja uspješnosti plivanja u ovom slučaju kraul tehnikom te navedenu problematiku istraže i znanstveno dokažu. Parametri koji će se ispitati u ovom istraživanju definiraju kako i koliki utjecaj imaju antropometrijske karakteristike na vrijednost plivačkih rezultata kraul tehnikom plivanja. Morfološke karakteristike ljudi, koji se s kibernetičkog aspekta mogu pojednostavljeno promatrati kao fleksibilni biološki aparati s određenim dimenzijama odavno su predmet istraživanja, pa će primjenjivost rezultata ovog istraživanja naći svoju primjenu u sportskoj praksi.

Cilj ovoga istraživanja je definirati utjecaj varijabli antropometrijskih karakteristika na uspješnost plivanja kraul tehnikom kod vrhunskih hrvatskih plivača. Rezultati dosadašnjih istraživanja mogu se generalno sistematizirati na pozitivne utjecaje tjelesnih opsega i mase na motoričke sposobnosti, te negativni utjecaji potkožnog masnog tkiva na rezultate u plivanju. Zahorec (1983) istraživao je utjecaj tjelesne konstitucije plivača na plivačku uspješnost pa su utvrđeni pozitivni utjecaji longitudinalne dimenzionalnosti skeleta na rezultate u plivanju i pozitivni utjecaji poprečnih mjera na sposobnosti koje predstavljaju apsolutnu količinu razvijene sile. S obzirom na to, da je veličina morfoloških obilježja uvjetovana genetski i utjecaj treninga na njih je minimalan, pa i Zahorec zaključuje da su za izbor plivačkih talenata presudne antropometrijske karakteristike. Pavić (2008) istraživala je i korisnost mjerenja morfoloških karakteristika u pojedinoj uzrasnoj dobi za efikasniju selekciju budućih plivača. Plivački treneri trebaju znati da su mišićno tkivo i potkožno masno tkivo znatno manje genetski determinirani nego što je skelet te su više podložni promjenama trenažnog procesa koji može utjecati na formiranje poželjne morfološke strukture.

METODE RADA

Mjerenja su izvršena na uzorku od 43 kategorizirana vrhunska plivača iz cijele Hrvatske. Kriterij odabira plivača kategorizacija je vrhunskih sportaša I.,

II. i III. kategorije prema kriterijima Hrvatskog olimpijskog odbora. Svi mjereni plivači članovi su Državnih plivačkih reprezentacija. Prema kriterijima HOO-a II. i III. kategorija može se postići isplivavanjem rezultata, dok je I. kategorija isključivo plasmanska, što znači da plivač mora osvojiti propisani plasman na nekom od službenih natjecanja (olimpijske igre, svjetsko prvenstvo i europsko prvenstvo). Ispitanici su muškog spola, starosne dobi ($x = 21,41$; $s = 3,67$), liječnički pregledani i klinički potpuno zdravi. Mjerenja su obavljena u Dijagnostičkom centru Kineziološkog fakulteta, bazenu PVC "Mladost" i teretani istog centra. Antropometrijski prostor zastupljen je testovima koji su sastavni dio IBP-a (International Biological Program), a pokrivaju četiri faktora antropološkog statusa (Medved, 1987), te vitalnog kapaciteta koji se često svrstava u longitudinalnu dimenzionalnost skeleta zbog međusobne visoke korelacije (Volčanšek, 1979).

Poštujući ciljeve istraživanja odabran je prediktorski sklop varijabli koji je relevantan kod plivanja kraul tehnikom pa je obuhvaćeni antropometrijski prostor zastupljen sa 27 varijabli, a kao kriterijska varijabla uzet je broj bodova na osnovi najboljeg rezultata u 50 metarskom bazenu po IPS (International Point Scores) sustavu, rezultat koji je služio kao osnova za određivanje vrijednosti, tj. broja bodova, izmjeren je na jednom od službenih natjecanja uz elektronsko mjerenje vremena (OMEGA). Rezultati dobiveni mjerenjem ispitanika obrađeni su u programu „Statistica for Windows 10.0“, a na skupu testova koji pokrivaju antropometrijski prostor nakon provedene *backward* regresijske analize bilo je moguće zaključiti koje varijable determiniraju uspjeh kod plivanja kraul tehnikom. Istraživanje u ovome radu provedeno je s ciljem utvrđivanja veličine utjecaja antropometrijskih karakteristika na vrijednost rezultata u plivanju kraul tehnikom kod vrhunskih hrvatskih plivača.

REZULTATI I RASPRAVA

Kao i u dosadašnjim istraživanjima, na temelju dobivenih vrijednosti moguće je potvrditi već ranije određene latentne strukture: longitudinalna dimenzionalnost skeleta, transverzalna dimenzionalnost skeleta, volumen i masa tijela te potkožno masno tkivo (Petrić, 1996, Leko, 2001). Tjelesna visina (VISTIJ) visoko je korelirana s mjerama koje se mogu svrstati u latentni prostor volumena i mase tijela (TEZTIJ, LBM), ali i s ostalim mjerama longitudinalne dimenzionalnosti skeleta (DUZSAK, DUZSTO, RSPRUK, SJEVIS) te s vitalnim kapacitetom što može biti razumljivo jer s većim vrijednostima tjelesne visine i određenih varijabli poput širine ramena (SIRRAM) i opsega grudnog koša (OGK) realno je očekivati i veći vitalni kapacitet.

Tablica 1. Osnovni deskriptivni parametri antropometrijskih varijabli

	Mean	Minimum	Maximum	Std.Dev.	Skewness	Kurtosis	max d
VISTIJ	186,20	175,50	199,10	4,73	0,48	1,12	0,10
DUZSAK	21,12	17,70	23,10	0,99	-0,80	2,56	0,10
DUZSTO	27,78	26,00	30,10	0,86	0,49	0,79	0,12
RSPRUK	193,62	182,00	206,00	6,22	-0,19	-0,79	0,12
SJEVIS	99,48	93,50	106,70	3,37	0,42	-0,49	0,90
SIRRAM	43,35	39,20	46,70	1,91	-0,09	-0,70	0,11
SIRKUK	29,80	25,80	33,50	1,73	0,16	-0,19	0,08
SIRSAK	8,53	7,25	9,55	0,41	-0,45	1,58	0,12
SIRSTO	10,15	9,10	11,20	0,51	0,00	-0,40	0,08
DRZ	5,62	5,10	6,20	0,31	0,24	-0,62	0,10
OPSNAT	56,82	52,50	65,80	2,89	0,76	1,00	0,12
OPSPOT	37,60	34,90	41,80	1,57	0,54	0,26	0,08
OPSNAD	32,33	27,60	35,50	2,14	-0,38	-0,66	0,09
OGK	101,48	90,60	110,00	4,84	-0,30	-0,45	0,10
TEZTIJ	79,97	64,60	103,70	7,03	0,63	2,16	0,10
LBM	73,02	61,51	86,89	5,55	0,22	-0,07	0,10
NABNAT	11,85	5,20	28,00	4,52	1,17	2,38	0,12
NABPOT	7,86	5,20	19,50	2,69	2,44	8,18	0,16
NABNAD	7,48	4,00	15,50	2,27	1,24	2,42	0,12
NABLED	9,98	6,30	16,40	2,24	0,70	0,35	0,11
NABTRB	11,11	5,00	25,20	5,43	1,09	0,03	0,24
NABSIK	10,66	5,00	25,40	5,21	1,29	1,12	0,18
NABPAZ	7,13	3,00	14,80	2,39	1,27	2,02	0,15
%PMT	8,04	4,06	18,73	3,04	1,50	3,13	0,13
FVK	7,00	4,90	9,57	0,98	0,37	0,45	0,12
FVK1	5,56	4,01	7,67	0,66	0,40	1,83	0,10
TIFFIND	80,37	65,10	96,70	7,93	-0,06	-0,39	0,07

LEGENDA: **Mean** – aritmetička sredina, **Minimum** – minimalna vrijednost, **Maximum** – maksimalna vrijednost, **Std.Dev.** – standardna devijacija, **Skewness** – koeficijent asimetričnosti distribucije, **Kurtosis** – koeficijent zakrivljenosti distribucije, **max D** – udaljenost između empirijske i teorijske relativne kumulativne frekvencije;

Visina tijela – VISTIJ, Dužina šake – DUZSAK, Dužina stopala – DUZSTO, Raspon ruku – RASPRUK, Sjedeća visina – SJEVIS, Širina ramena – SIRRAM, Širina kukova – SIRKUK, Širina šake – SIRSAK, Širina stopala – SIRSTO, Dijametar ručnog zgloba – DRZ, Opseg grudnoga koša – OGK, Opseg nadlaktice – OPSNAD, Opseg natkoljenice – OPSNAT, Opseg potkoljenice – OPSPOT, Ukupna bezmasna masa – LBM, Težina tijela – TEZTIJ, Nabor nadlaktice – NABNAD, Nabor na trbuhu – NABTRB, Nabor na leđima – NABLED, Nabor natkoljenice – NABNAT, Nabor potkoljenice – NABPOT, Nabor suprailiokristalno – NABSIK, Nabor pazuha – NABPAZ, Potkožno masno tkivo % - PMT, Forsirani vitalni kapacitet – FVK, Forsirani ekspirirani volumen u 1 sekundi – FVK1, Tiffneauunov indeks – TIFFIND.

Tablica 2. Korelacijska matrica antropometrijskih varijabli s kriterijskom varijablom ($p < 0,05$)

	IPS
VISTIJ	-0,05
DUZSAK	-0,08
DUZSTO	0,14
RSPRUK	0,46
SJEVIS	0,43
SIRRAM	0,27
SIRKUK	0,07
SIRSAK	0,00
SIRSTO	-0,11
DRZ	-0,44
OPSNAT	0,06
OPSPOT	0,25
OPSNAD	0,30
OGK	0,12
TEZTIJ	0,17
LBM	0,18
NABNAT	0,03
NABPOT	-0,02
NABNAD	-0,03
NABLED	-0,08
NABTRB	0,06
NABSIK	0,11
NABPAZ	-0,09
%PMT	-0,16
FVK	0,14
FVK1	0,14
TIFFIND	-0,05

LEGENDA: Visina tijela – VISTIJ, Dužina šake – DUZSAK, Dužina stopala – DUZSTO, Raspon ruku – RASPRUK, Sjedeća visina – SJEVIS, Širina ramena – SIRRAM, Širina kukova – SIRKUK, Širina šake – SIRSAK, Širina stopala – SIRSTO, Dijametar ručnog zgloba – DRZ, Opseg grudnoga koša – OGK, Opseg nadlaktice – OPSNAD, Opseg natkoljenice – OPSNAT, Opseg potkoljenice – OPSPOT, Ukupna bezmasna masa – LBM, Težina tijela – TEZTIJ, Nabor nadlaktice – NABNAD, Nabor na trbuhu – NABTRB, Nabor na leđima – NABLED, Nabor natkoljenice – NABNAT, Nabor potkoljenice – NABPOT, Nabor suprailiokristalno – NABSIK, Nabor pazuha – NABPAZ, Potkožno masno tkivo % - PMT, Forsirani vitalni kapacitet – FVK, Forsirani ekspirirani volumen u 1 sekundi – FVK, Tiffneauunov indeks – TIFFIND.

Slične rezultate potvrđuje Volčanšek (1979) koji je također utvrdio visoku korelaciju tjelesne visine i vitalnog kapaciteta. Opseg natkoljenice (OPSNAT) nalazi se u statistički značajnoj korelaciji sa skoro svim ostalim antropometrijskim varijablama, a u najvećoj korelaciji (0,85) s težinom tijela (TEZTIJ). Najveću korelaciju (0,9) među antropometrijskim varijablama moguće je očitati između LBM i TEZTIJ, što upućuje da povećanje tjelesne težine uvelike je rezultat povećanja ukupne bezmasne mase. Juriamae i sur. (2007) dobili su značajne razlike u ukupnoj bezmasnoj masi među plivačima predpubertetne i pubertetne dobi, što upućuje da sa sazrijevanjem udio ukupne bezmasne mase više utječe na težinu tijela nego postotak masnog tkiva u tijelu (%PMT) iako je korelacija u ovom istraživanju pozitivna, no u puno manjem obimu (0,43).

Ukupna bezmasna masa tijela (LBM) u vrlo je visokoj korelaciji sa svim opsezima što, također, ukazuje da kod vrhunskih sportaša, veličina opsega pojedinih dijelova tijela rezultat je razvijenog mišićnog sustava i mišićne mase, dok istraživanje provedeno na mlađim dobnim skupinama (Leko, 2001) upućuje da kod te dobi povećanje u opsegu rezultat je povećane količine masnog tkiva, odnosno rezultati pokazuju postojanje pozitivnih korelacija između mjera kožnih nabora i opsega te u toj dobi porast mišićne mase nije dovoljan da bi značajno utjecao na opsege tijela dok kod vrhunskih sportaša upravo mišićna masa ima taj utjecaj.

Vitalni kapacitet (FVK) u ovome istraživanju svrstan je u antropometrijski sklop varijabli, kao i u već nekim dosadašnjim istraživanjima (Leko, 2001, Volčanšek, 1979), s obzirom da pokazuje statistički pozitivnu i relativno visoku korelaciju s longitudinalnim dimenzijama, a također i s opsegom grudnog koša i širinom ramena što je i očekivano da će plivači s većim vrijednostima u varijablama OGK i SRRAM imati veće vrijednosti u varijabli FVK.

ZAKLJUČAK

Antropometrijske karakteristike pokazale su relevantan utjecaj na vrijednost rezultata u plivanju kraul tehnikom kod vrhunskih hrvatskih plivača. Kod izbora prediktorskih varijabli obuhvaćen je prostor antropometrije s 27 varijabli, kriterijska varijabla bio je broj bodova na osnovi najboljeg rezultata u 50 metarskom bazenu po IPS (International Point Scores) sustavu, rezultat koji je služio kao osnova za određivanje vrijednosti, tj. broja bodova. Za testiranje utjecaja antropometrije, na vrijednost rezultata koji je izražen bodovima i

time standardiziran s obzirom na dionicu korištena je deskriptivna statistika. Rezultati utjecaja antropometrijskih karakteristika na postizanje vrhunskih rezultata kraul tehnikom sa čak 86% determiniraju uspjeh kraul tehnikom, dok samo 4 varijable pokazuju statistički značaja utjecaj na kriterij. Nakon provedene analize moguće je zaključiti kako plivači s većom sjedećom visinom, manjom visinom tijela te manjim dijametrom ručnog zgloba, opsegom natkoljenice i postotkom masnog tkiva, no većim suprailiokristalnim kožnim naborom mogu postići bolje vrijednosti u kriterijskoj varijabli.

Dobiveni rezultati ukazuju na potrebu praćenja statusa plivača kraulaša u navedenim antropometrijskim karakteristikama pogotovo na one varijable na koje je moguće utjecati trenažnim procesom (%TM, kožni nabori i opsezi) dok u procesu selekcije treba obratiti pozornost na longitudinalnu dimenzionalnost. Iako je %TM dobar prediktor kod mlađe dobi, sjedeća visina kod vrhunskih plivača ukazuje na najveću prediktivnu moć.

Među antropometrijskim varijablama, iz prosječne visine i težine tijela može se zaključiti kako vrhunski hrvatski plivači pokazuju više vrijednosti u navedenim varijablama naspram ipak mlađih plivača čije vrijednosti su iznosile 1.76 ± 0.09 za visinu, te 63.3 ± 10.9 za težinu, a slični rezultati za gotovo isti uzorak dobiveni su dosadašnjim istraživanjima s rezultatima 1.77 ± 0.05 i 69.1 ± 7.9 za visinu i težinu. U usporedbi s elitnim plivačima na duge pruge te one u otvorenim vodama (177.3 ± 7.06 , 71.25 ± 8.08), hrvatski plivači pokazuju također više rezultate, a u usporedbi s plivačima slične dobi i vrhunskog profila rezultati prikazuju slične vrijednosti u visini i težini sa dobivenim vrijednostima vrhunskih hrvatskih plivača.

LITERATURA

Jürimäe, J., Haljaste, K., Cicchella, A. (2007). Analysis of swimming performance from physical, physiological and biomechanical parameters in young swimmers. *Pediatric Exercise Science*, 19(1): 70-81.

Leko, G. (2001). Definiranje odnosa motoričkih sposobnosti i antropometrijskih karakteristika plivača. (Doktorska disertacija, Sveučilište u Zagrebu). Fakultet za fizičku kulturu Sveučilišta u Zagrebu.

Medved, R. (1987). *Sportska medicina* (II). Zagreb: Jumena

Petrić, S. (1996). Konstrukcija modela selekcije plivača i plivačica mlađih uzrasnih kategorija u nekim antropološkim karakteristikama. (Doktorska disertacija, Sveučilište u Zagrebu). Zagreb: Fakultet za fizičku kulturu Sveučilišta u Zagrebu.

Pavić, R. (2008). Gender diferencials of morphological characteristics for primary school children involved or uninvolved in swimming trainings, The 2 Internnatioal Conference on Advances and Systems Research, Zadar 2008.

Pavić, R. (2008). «Sex differences in motor characteristics of elementary children included/not included in swimming training» Collegium Antropologicum, 32 (2008) 3:829-834

Volčanšek, B. (1979). Utjecaj antropometrijskih i motoričkih dimenzija na rezultat u plivanju. (Doktorska disertacija, Sveučilište u Zagrebu). Zagreb: Fakultet za fizičku kulturu Sveučilišta u Zagrebu.

Zahorec, J. (1983). Vrednovanje somatskih i funkcionalnih parametara kao kriterija pri izboru talenata za plivanje. JSFKMS, 6, 73-7.

Kinesiology interventions during the contest period in football club koper

Marko Vidnjević

Univerza na Primorskem, Koper, Slovenija

ABSTRACT

Introduction: Modern professional footballers are exposed to many physical and psychological requirements. In order to achieve positive results in the matches they should therefore take care of their health in three areas: physiognomy, cognition and dietetics. The science of movement, which is called Kinesiology, has potentials that can be very useful for professional footballers. *Methods:* The article includes a survey which was carried out in Football Club (FC) Koper during the period of the domestic football season because of the urgent need for improving physical and mental abilities through kinesiological interventions carried out by experts from the University Kinesiology Center (UKC). In three different periods experts used the following methods: Tensiomyography (TMG), bioelectrical impedance analysis (BIA), questionnaire about eating habits, a seven-part test called the Functional Movement Screen (FMS)™ and cognitive interview. *Conclusion:* Because FC Koper finished Slovenian Cup Championship 2015 as a winner, we can assume that our kinesiological intervention has brought successful results.

Keywords: Kinesiology, Interventions, Tensiomyography, Football, Athlete's;

INTRODUCTION

Football is one of the most popular sports in the world today at least since the late nine-teenth century and its international diffusion by the British. The 'global game' spans culturally diverse societies in all continents; an estimated 250 million people are direct participants, around 1.4 billion have an interest, and foot-ball's flagship tournament, the World Cup finals, attracts a cumulative

global television audience of 33.4 million. Only relatively recently has the game's unparalleled cross-cultural appeal been realized financially. In 1998, football's world governing body, FIFA, controlled contracts worth some £4 billion; by 2001, world football's turnover was estimated at around £250 billion, equivalent to the Netherlands' GDP (Walvin, 2001). Given these figures alone, we might propose, to adapt Durkheim, that of all contemporary cultural forms, football is 'the serious life'.

Despite the impact and popularity of soccer, and the growing field of soccer-related scientific research, little attention has been devoted to the nutritional intake and eating habits of soccer players. Moreover, the few studies that have addressed this issue suggest that the nutritional intake of soccer players is inadequate, underscoring the need for better adherence to nutritional recommendations and the development and implementation of nutrition education programs (García-Rovés et al., 2014).

UEFA (Union of European Football Associations) has expressed its concern over the physical and mental demands being placed on modern professional footballers, and the translation of these physical and mental demands into injury syndromes. A research project, specifically aimed at evaluating the exposure to football and the risk of injury for top-level football players in Europe, was therefore initiated in 1999 (Häggglund et al., 2005).

Injuries are more common in football compared to most other types of sport (de Loes, 1995).

Researchers tried to identify the socialpsychological factors that could affect athlete's motivation (Ntoumanis et al., 2007). For example coaching behaviour is as one of the social factors and it could lead to a change in the motivation of the athletes.

This study is based on FC Koper. During the contest period FC Koper needed kinesiology intervention because the professional footballers wanted to improve their physical and mental capabilities.

The role of kinesiology as a science of movement is becoming increasingly important. Modern society is already seriously at risk because of the consequences of the inactive lifestyle and related problems of physical inefficiency and deterioration of health and quality of life. Kinesiology is an interdisciplinary approach involving all segments of human activity. This science is interested in the effects of the direct working and living environment on the adaptation of the human organism and in the consequences of human

activity under the influence of physical / sports activities, specific professional activities and functioning in extreme environments.

Head coach Mr. Ščulac Alen and goaltender coach Mr. Volk Robert of FC Koper contacted the University Kinesiology Center (UKC) in Koper, which operates in the context of the Scientific Research Centre of the University of Primorska. UKC cares for the transfer of research results, new ideas, gadgets and (intervention) programs into practice, more effective marketing and better utilization of measurement and diagnostic equipment as well as possibilities for its upgrading, maintenance and modernization. UKC creates interventions and recommendations for the optimisation of workout for recreational and top level athletes, based on a holistic analysis of the motor system. In the case of FC Koper the professional team of the UKC has immediately started with kinesiological interventions in three areas: fitness level/physiognomy, cognition/motivation and appropriate nutrition/dietetics.

METHODS

In three different periods experts used next methods: *the first part* of the kinesiology interventions was in all three fields: physiognomy, dietetics and cognition and it took place between December 2014 and January 2015. Professional team of kinesiologists, antropologists and nutritionist used the following methods on 25 football players: *Tensiomyography (TMG)* as method of evaluating muscles status, *bioelectrical impedance analysis (BIA)* to measure body composition, *questionnaire about eating habits*, a seven-part test called *the Functional Movement Screen for predicting injuries (FMS)™* and *cognitive interview* to increase motivation; *the second part* of interventions was again in all three fields and it was held in February and March 2015, but only with certain/exposed athletes. In February experts have used the FMS test in parallel with TMG. They have prepared a program of menu and dietary supplements, and proposed common breakfasts before the first daily training or match. In March, they carried out measurements of VO₂max for some players and compare their oxygen consumption. At the same time, the experts together with the professional team of footballers went to the matches. On the way, the experts prepared motivational trainings and in this way they encouraged and guided the contestants to success.; *the third part* was oriented on the strict implementation of trainings, intake of nutrition and dietary supplements, and the proper motivation for the match and it took place in April 2015.

The paper also includes literature research which was based on reading scientific literature about kinesiological interventions to improve the health and safety of football players and consequently their performance on football matches by domestic and foreign authors.

RESULTS

Analysis of body composition- Tanita MC 780

Table 1: Measurements of body composition

MC-780	Result	Normal
Weight	78,8 ± 7,8 kg	62,8 – 79,2 kg
Fat %	11,7 ± 3,8 %	8,4 – 19,2 %
Fat Mass	9,4 ± 3,6 kg	6,3 – 17,2 kg
FFM	69,5 ± 5,5 kg	info
Muscle Mass	66,0 ± 5,3 kg	55,4 – 70,2 kg
TBW %	63,2 ± 2,7 %	info
BMI	23,9 ± 1,6	19,2 – 24,2
Bone Mass	3,4 ± 0,3 kg	info

Tensiomyography (TMG)

Table 2: Team Contraction Times

Muscle	Lateral Side	Average Tc [ms]	Standard Deviation Tc
BF Biceps Femoris	LEFT	30.01	8.44
	RIGHT	31.03	11.47
ES Erector Spinae	LEFT	14.19	1.56
	RIGHT	14.61	1.81
GL Gastrocnemius	LEFT	20.03	4.60
	RIGHT	23.15	9.06
GM Gastrocnemius Medialis	LEFT	24.40	3.03
	RIGHT	23.89	2.70
RF Rectus Femoris	LEFT	30.79	4.40
	RIGHT	31.77	5.31
TA Tibialis Anterior	LEFT	22.13	10.19
	RIGHT	24.97	10.32
VL Vastus Lateralis	LEFT	23.97	3.16
	RIGHT	23.06	2.89
VM Vastus Medialis	LEFT	23.73	2.29
	RIGHT	22.94	2.60

Eliteness comparison:

In Figure 1 comparison between averages of two Slovenian teams, five elite Italian teams, and elite Spanish team is presented. We could see shorter contraction times in almost all muscles in Italian and Spanish players, except in GM. Statistical significance revealed shorter contraction time (from Slovenian teams) in AL for Italian teams; and in RF, BF, TA, GL, and AL for Spanish team.

Figure 1: Comparison between selected skeletal muscle's contraction time averages between football teams of different eliteness.

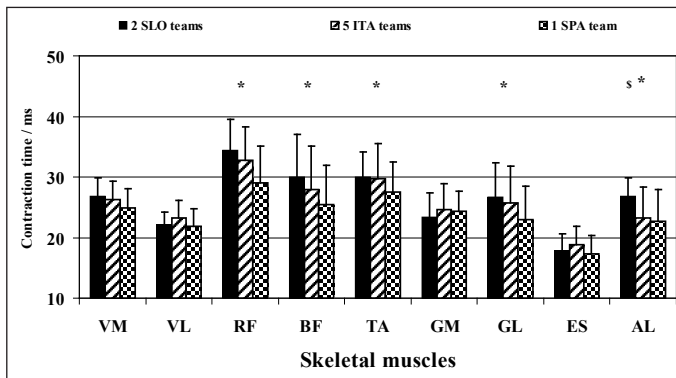

\$...significant difference between SLO and ITA

*...significant difference between SLO and SPA

**Questionnaire about eating habits:
Anamnesis of dietary and lifestyle habits**

Appetite. 21 footballers estimate to have a good appetite and 4 players estimate that have a moderate appetite. 19 players enjoy eating and 6 footballers only occasionally enjoy eating. *Dietary habits.* 18 respondents eat every day at the same time and 7 footballers merely sometimes eat every day at the same time. 9 players sometimes drop the meal. Breakfast was the most frequently skipped meal, followed by dinner. 8 players do not eat certain foods, believing that this is not an appropriate food for them. Football players frequently avoid fast foods and sweets. 17 players often eat something between meals. Footballers most frequently eat fruits, followed by nuts, then chocolate. 20 players most commonly eat at home, others eat in the restaurants. 23 players eat certain foods, believing that this is an appropriate food for them. Football players frequently consume meat, followed by pasta, vegetables and rice in fourth place. *Food choice.* Only 1 footballer is allergic to certain foods

INVITED LECTURES
POZVANA PREDAVANJA

and these are gluten, peppers, peaches and pork. 2 footballers do not eat pork for religious reasons. Only one footballer takes medication and this is Euthrox. 21 players drink milk. Most often they consume whole cream milk followed by skimmed milk. Almost all footballers consume cooked food, followed by baked food. More than half of all players consume more than ten hot meals weekly and only 3 players consume less than six hot meals weekly.

DISCUSSION

Measurements and analysis was carried out in order to get a complete picture - profile of abilities and capacities of footballers and because of the identification of group and individual's weak points. With measurements and analysis, a basis for planning and individual adaptation of trainings (homogeneous groups) and for more objective and more suitable determination of gaming positions were obtained.

During the 90s, tensiomyography (TMG) came out. It was an innovative technique developed by the professor Valenčič and it started to be used ten years ago for evaluating the athletes. In general, TMG was developed at the Faculty of Electrical Engineering of the University of Ljubljana (Slovenia) as a non-invasive, selective and simple-to-use method that allows the assessment of skeletal muscle contractile properties (Pišot et al., 2008; Šimunič et al., 2011;). Bioelectrical impedance analysis (BIA) is relatively simple, quick (takes only a few minutes), and non-invasive which gives reliable measurements of body composition with minimal intra- and inter- observer variability. BIA has become a popular method for estimation of body composition during the last two decades. Since 1990, more than 1600 published articles have been reported using BIA as a tool of body composition measurement (Barbosa-Silva & Barros, 2005). Adequate nutrient intake is important to support training and to optimise performance of elite athletes. Nutritional knowledge has been shown to play an important role in adopting optimal nutrition practices. The aim of the questionnaire about eating habits was to investigate the relationship between the level of nutritional knowledge and dietary habits of footballers from FC Koper. In this part, the experts predicted at least 10-15% increase of performance, even when using dietary supplements such as caffeine and creatine. They have recommended the complete abstinence from alcohol, because it is a general opinion that wine with food and beer after training does not cause harm. The Functional Movement Screen (FMS)[™] was used because is an efficient and reliable method to screen movement patterns during the

performance of specific tasks. Establishing a valid method of identifying athletes at elevated risk for injury could lead to intervention programs that lower injury rates and improve overall athlete performance. The cognitive interview contained questions about three areas of motivation: competitive-need achievement, sport orientation, self-motivation, and the area of values. The theory of values (Musek, 2000), on which cognitive interview was based, consists of a hierarchic system of values. On the highest levels all values of middle and broader range (hedonistic, potency, moral, fulfillment) join together in two major categories. The Apollonian major category combines all values pointing to orientation towards human effect and quantity. The Dionysian major category stands for perfection and quantity.

Based on the measurements and analysis, the following training actions for footballers were prepared:

- Warming up / main part of (1-2 goals!) / concluding part;
- First, the contents which require maximum rested footballers, accuracy, and the contents which require maximum, fast and agile actions;
- Later the contents, which cause the fatigue and exhaustion;
- The order of the training contents (for example): Coordination, technique; speed and agility; quick / agile power / activation; training for stability; aerobic endurance / speed endurance / maximum power (hypertrophy); mobility.

CONCLUSIONS

It is quite unusual to intervene during the competition season because athletes already have steady program of trainings and adequately prepared condition level. Something more can be done only with the interventions in the rehabilitation of injuries and regeneration, and with the dietary supplements. At the same time, experts have only experimentally carried out the experimental therapy in a hyperbaric chamber. Only by observing they followed potential changes, which based on the reporting of certain athletes. Basis for urgent kinesiological interventions was also turbulent period of the first part of competition season, when the team rapidly declined in physical strength and the motivation to play. This was followed by replacement of coach and the situation has become even more critical. This was followed by yet another crisis in the game, and reuse replacement of coach. Nevertheless, and with the help of UKC, FC Koper finished cup championship 2015 as winner. In this case, the kinesiological intervention has brought successful results. Although experts

believe that UKC could significantly contributed to solving the problems if his team was engaged already at the time of preparatory period.

REFERENCES

Barbosa-Silva M. C., Barros A. J. (2005). Bioelectrical impedance analysis in clinical practice: a new perspective on its use beyond body composition equations. *Curr Opin Clin Nutr Metab Care*, 8:311-317.

García-Manso J. M., Rodríguez-Matoso D., Sarmiento S., De Saa Y., Vaamonde D., Rodríguez-

García-Rovés P. M., García-Zapico P., Patterson A. M. and Iglesias-Gutiérrez E. (2014). Nutrient Intake and Food Habits of Soccer Players: Analyzing the Correlates of Eating Practice. Department of Functional Biology, Area of Physiology, University of Oviedo. Retried 30 May 2015 from: http://www.google.si/url?sa=t&rct=j&q=&esrc=s&source=web&cd=3&ved=0CDIQFjAC&url=http%3A%2F%2Fwww.mdpi.com%2F2072-6643%2F6%2F7%2F2697%2Fpdf&ei=S75pVaSOLYHKsgG-074CoDw&usg=AFQjCNFqr63YCB154ILlyRTaEWdFsv7sjw&sig2=tqbjRw8x-O2oFZCbeQkPi_g&bvm=bv.94455598,d.bGQ

Hägglund M., Waldén M., Bahr R., et al. (2005). Methods for epidemiological study of injuries to professional football players: Developing the UEFA model, *Br J Sports Med*; 39:340-346.

Manso J. M. (2010). Reproducibility of muscle response measurements using tensiomyography in a range of positions. *Revista Andaluza de Medicina del Deporte*, 3(3), 81-86.

Meeuwisse W. H. (1994). Assessing causation in sport injury: A multifactorial model. *Clin J Sport Med* 4: 166–170.

Musek J. (2000). Nova psihološka teorija vrednot [New psychological theory of values]. Ljubljana: Educy.

Ntoumanis N., Vazou S. & Duda J. L. (2007). Peer-created motivational climate. In S. Jowett, & D. Lavallee (Eds.), *Social psychology in sport* (pp. 145e156). Champaign, IL: Human Kinetics.

Pišot R., Narici M. V., Šimunič B., De Boer M., Seynnes O., Jurdana M., Biolo G. & Mekjavić I. B. (2008). Whole muscle contractile parameters and thickness loss during 35-day bed rest. *European Journal of Applied Physiology* 104(2), 409–14.

Šimunič B., Degens H., Rittweger J., Narici M., Mekjavić I. B., & Pišot, R. (2011). Noninvasive estimation of myosin heavy chain composition in human skeletal muscle. *Medicine and Science in Sports and Exercise*, 43(9), 1619–25.

Walvin J. (2001). *The Only Game: Football In Our Time.*, London: Pearson.

Analysis of the predictive value of basic motor tests for young female volleyball players

Željko Krneta, Sunčica Poček

Faculty of Sports and Physical Education, Novi Sad, Serbia

ABSTRACT

In a sample of 186 female volleyball players and 172 students who were not dealing with organized physical activity, a battery of seven basic motor tests was used, in order to determine the predictive value of a battery of tests in different age categories. Three homogeneous age categories were formed based on decimal years: young pioneers from 11.50 to 13.5 decimal years, older pioneers from 13.51 to 14.5 decimal years and youth from 14.51 to 16.0 decimal years. The application of discriminant analysis and logistic regression analysis, predictive value of the battery of tests in distinguishing of groups of female volleyball players and students in each category was formed. The results showed that the analyzed battery of tests is a good predictor in the classification of volleyball players in all three categories, with over 80% accuracy in the classification. The highest predictive value was showed by *Seated straddle stretch* and *Speed of arm movement* tests.

Keywords: volleyball, motor abilities, prediction, female players.

INTRODUCTION

The problem of selection of young volleyball players and the subsequent monitoring of their motor development is still current in volleyball practice. Both in terms of choice of appropriate motor tests for evaluation of motor functioning and in terms of the possibilities of their application in practice. In the initial selection, the experts rely heavily on the assessment of levels of basic motor abilities and body height, as dominant characteristics in the selection of children to engage in volleyball. This is understandable, since in a number of studies statistically significant difference was determined between volleyball players and girls who are not engaged in volleyball in regards to height and

basic motor skills (Morrow, Hosler, & Nelson, 1980; Vuković, Krneta, Đurđić, & Simić, 2007; Milić, Grgantov, & Katić, 2012). In almost all research the importance of tests for evaluation of explosive leg strength, agility and flexibility in the selection of female children to engage in volleyball is emphasized. Different, preferably standardized and metrically tested tests for evaluation of basic motor skills of girls are used in doing so. However, their predictive value is rarely checked for the selection of children of different age categories. The problem of application of these tests in older children, who are engaged for many years in the training and competitive process is not enough studied. The assumption is that in children who are engaged in this sport for many years, these tests have a higher predictive value in relation to specific motor tests. With that in mind, this research was conducted with the idea to answer the following two questions: 1) What is the predictive value of one standard battery of basic motor tests for the classification of young volleyball players of different age categories? and 2) Which motor tests have good predictive value in assessing basic motor abilities of volleyball players of different age categories.

METHODS

The sample consisted of 358 young girls from the territory of Vojvodina, 172 girls which were not engaged in organized physical activity and 186 female volleyball players who were for at least three years included in the training and competition program of sports clubs. The total sample, which is based on the decimal year, was divided into three homogeneous age categories: younger pioneers 11.50 to 13.5 decimal years, older pioneers 13.51 to 14.5 decimal years and youth 14.51 to 16.0 decimal years (Table 1). All respondents were healthy and voluntarily participated in the study during the course of measurement.

Table 1. Distribution of respondents by age categories (number of respondents, decimal year)

Groups	Younger pioneers	Older pioneers	Youth	Sum
Volleyball players	65 (12,9±0,41)	65 (13,9±0,31)	56 (15,0±0,34)	186
Schoolgirls	69 (12,4±0,58)	56 (13,9±0,29)	47 (14,9±0,22)	172
Sum	134	121	103	358

The research was conducted in several towns in Vojvodina (Subotica, Sombor, Zrenjanin, Klek, Sremska Mitrovica, Sremski Karlovci and Novi Sad) within the project "Anthropological status and physical activity of children and

youth of Vojvodina" of the Faculty of Sport and Physical Education, University of Novi Sad.

The sample of variables was formed using the standardized battery tests for the assessment of basic motor skills of children (Bala, 2010). The battery included seven tests for assessment of motor abilities in children according to the model of Gredelj, Metikoš, Hošek and Momirović (1975). For the assessment of coordination *Obstacle course backwards* (0,97) and *Slalom with three balls* (0,92), for the assessment of speed of movement *20m running speed* (0,97), for the assessment of speed of alternative movements *Speed of arm movement* (0,96), for the assessment of flexibility *Seated straddle stretch* (0,97), for the assessment of explosive leg strength *Standing broad jump* (0,95) and for the assessment of repetitive force *Crossed-arm sit-ups* (0,94). All measurements were done in appropriate gyms and in standard conditions for the application of the above tests. In accordance with the standardization of measurement, all motor tasks were measured after the adequate preparation and the trial attempt.

Basics of descriptive statistics are presented through the arithmetic mean and standard deviation of variables for each of the three established categories of volleyball players and students. Before basic statistical analysis, by applying the Shapiro-Wilk test, the distribution of data was tested and it was found that there is no significant deviation from the normal distribution in the applied variables. The predictive value of the battery of basic motor tests was analyzed using Discriminative analysis as the primary method and Logistic regression analysis as a supplementary method. Predictive value of test batteries was determined in the classification of young volleyball players as well as the importance of certain variables in the prediction of affiliation of subjects to volleyball or student groups. The alpha significance level of 0.05 was used for all statistical analysis. Data processing was done in the statistical package IBM SPSS 20.0 (ID: 729225).

RESULTS

Results of arithmetic means and standard deviations of age categories of respondents (Table 2) showed that the volleyball players in all three categories have better results than the students. Volleyball players also showed greater homogeneity of results than their peers. The observed differences are statistically significant in most of the variables except in the *Slalom with three balls* variables, with all three age groups and *20m running speed* with two groups of respondents.

Table 2. Arithmetic mean and standard deviation of variables for volleyball players (VP) and schoolgirls (SG).

Variables	Younger pioneers		Older pioneers		Youth	
	VP	SG	VP	SG	VP	SG
20m running speed (s)	4,2±0,2	4,3±0,4	4,2±0,3	4,3±0,4	4,1±0,3	4,1±0,3
Obstacle course backwards (s)	15,3±4,7	17,5±4,6	14,9±4,2	17,1±5,1	13,6±2,5	16,9±4,4
Slalom with three balls (s)	39,9±7,9	40,6±8,3	37,3±7	35,9±4,6	34,1±4,4	37,6±7,9
Speed of arm movement (fr.)	32,8±4,1	28,5±3,5	33,5±4	31,6±4,2	34,8±4,1	30,7±4,2
Seated straddle stretch (cm)	67,4±8,1	54,8±10,8	69,3±10,5	59,0±8,9	70,1±8,7	61,6±13,5
Standing broad jump (cm)	177,2±16,6	166,3±21,2	185,3±20	175,6±24,1	191,4±17,5	182,2±22,1
Crossed-arm sit-ups (fr.)	39,6±5,9	36,1±8,1	43,4±6,9	40,0±7,2	44,7±6	39,3±7

Discriminant analysis of applied variables showed a high level of statistical significance in the prediction of group affiliation of volleyball players and students in all three categories of respondents (Table 3). In the category of young pioneers the system of variables correctly classified 81.5% of volleyball players, in the category of older pioneers 78.5%, and in the category of cadet even 89.3% volleyball players. Statistically significant difference was determined in all three categories between young volleyball players and their student peers ($p < 0,01$). In the group of younger pioneers and youth around 39% of variance of dependent variable was described, while in the group of older pioneers that percentage was smaller, around 30%.

In all three age categories the highest contribution to defining of differences between volleyball players and students was found in variables *Seated straddle stretch* and *Speed of arm movement*. In the category of young pioneers these two variables define the observed differences. In both older categories the other variables can be found as important predictors, primarily *Obstacle course backwards*, *Crossed-arm sit-ups* and *Standing broad jump*, with significantly lower coefficients. Sizes and signs of group centroids on the discriminant function clearly indicate that the groups of volleyball players are significantly better than students in most of the analyzed variables.

Table 3. Results of discriminative analysis of variables for three categories of participants.

Variables	Younger pioneers	Older pioneers	Youth
20m running speed (s)	-0,26	-0,42	-0,01
Obstacle course backwards (s)	-0,30	-0,37	-0,60
Slalom with three balls (s)	-0,05	0,18	-0,35
Speed of arm movement (fr.)	0,70	0,37	0,62
Seated straddle stretch (cm)	0,82	0,83	0,48
Standing broad jump (cm)	0,36	0,35	0,29
Crossed-arm sit-ups (fr.)	0,31	0,38	0,52
Wilks' Lambda/sig.	0,61 / 0,00	0,40 / 0,00	0,61 / 0,00
% of variance	39,2	29,1	38,9
% of classification	81,5	78,5	89,3
Volleyball players centroid	0,82	0,59	0,72
Schoolgirls centroid	-0,77	-0,68	-0,86

Results of the logistic regression analysis confirmed the findings of discriminative analysis (Table 4). In all three categories of respondents the variables *Seated straddle stretch* and *Speed of arm movement* best define the affiliation of analyzed groups. The model as a whole has a good predictive value and in all three categories classifies volleyball players with over 80% of accuracy. Percentage of the explained variance of the dependent variable is in the range of 30 - 54%. The model has the best prediction in the oldest category, where five of the seven variables are statistically significant in predicting volleyball players.

Table 4. Results of logistic regression analysis

Variables	Younger pioneers		Older pioneers		Youth	
	Wald	Sig.	Wald	Sig.	Wald	Sig.
20m running speed (s)	0,09	0,77	0,76	0,38	4,38	0,04
Obstacle course backwards (s)	0,00	0,96	0,67	0,41	6,86	0,01
Slalom with three balls (s)	0,68	0,41	0,78	0,38	0,16	0,69
Speed of arm movement (fr.)	9,14	0,00	6,82	0,01	9,05	0,00
Seated straddle stretch (cm)	16,83	0,00	14,41	0,00	4,14	0,04
Standing broad jump (cm)	0,04	0,84	0,12	0,73	0,18	0,67
Crossed-arm sit-ups (fr.)	1,43	0,23	1,47	0,23	9,00	0,00
Chi-square/sig.	64,7	0,00	42,0	0,00	53,4	0,00
% of variance	38,3 - 51,1		29,3 - 39,2		40,5 - 54,1	
% of classification	81,5		80,0		82,1	

DISCUSSION

The conducted analysis showed that the applied test battery has a statistically significant predictive value in all three categories of female volleyball players. A high percentage of classification, in average around 80%, confirms that the analyzed basic motor tests are suitable for use in the later period of development of volleyball players, not only in the initial selection. The analyzed categories of volleyball players cover the periods of the most intense development of their motor skills and technical and tactical elements of the game. At the same time, a high level of basic motor skills is an important prerequisite for the proper adoption and improvement of elements of the volleyball game. Therefore, the improvement of basic motor abilities of volleyball players of all age categories is very important, as well as continuous monitoring and evaluation of the level of their development.

High predictive value of tests *Seated straddle stretch* and *Speed of arm movement* is expected. The high level of flexibility of the trunk and legs is very important in defensive actions of volleyball players and the speed of the dominant hand in the efficiency of the manifestation of spike and serve. This finding coincides with the results of Katić, Grgantov and Jurak (2006) who point out, among other things, the importance of these motor skills and their contribution to the adoption of the volleyball technique. These motor skills are given great importance in the training volleyball players, which probably contributed to the significant differences of volleyball players and students of the analyzed age categories. From the two tests used for assessment of coordination, only test *Obstacle course backward* showed good predictive value, especially with two older age categories of volleyball players. The situation is similar with the test for evaluation of the repetitive force of the trunk *Crossed-arm sit-ups*, where the increase in the age category of the volleyball player led to the increase of the predictive value of the test, which is undoubtedly the consequence of multi-year training process. Surprising was the low predictive value of the test *Standing broad jump* which is in great use in volleyball practice and research. Although the significant differences in average values of the long jump of volleyball players and students are undeniable (6,3%), they have not dominantly defined differences in the applied battery of tests. In all three analyzed categories this test has a solid discriminative score (around 0.35) and contributes to the discriminative value of the whole battery. Tests *20m running speed* and *Slalom with three balls* did not show good predictive value on analyzed samples.

CONCLUSIONS

Based on these results we can conclude that the analyzed battery of basic motor tests has a good predictive value in the classification of volleyball players in all three age categories of volleyball players. With the reduction of number of tests to five: *Seated straddle stretch*, *Speed of arm movement*, *Obstacle course backwards*, *Standing broad jump* and *Crossed-arm sit-ups*, it can be recommended for use in all analyzed categories of volleyball players, primarily for monitoring and evaluation of the achieved level of basic motor skills important for volleyball. For the classification of volleyball players within the gaming selections, it is necessary to apply specific motor tests and evaluation of technical and tactical elements of the game, as stated by Gabbett, Georgieff, & Domrow (2007).

REFERENCES

- Bala, G. (2010). *Metodologija kineziometrijskih istraživanja sa posebnim osvrtom na motorička merenja*. Novi Sad: Fakultet sporta i fizičkog vaspitanja.
- Gabbett, T., Georgieff, B., & Domrow, N. (2007). The use of physiological, anthropometric, and skill data to predict selection in a talent-identified junior volleyball squad. *Journal of Sports Sciences*, 25(12), 1337-1344.
- Gredelj, M., Metikoš, D., Hošek, A. i Momirović, K. (1975). Model hijerarhijske strukture motoričkih sposobnosti. I. Rezultati dobijeni primjenom jednog neoklasičnog postupka za procjenu latentnih dimenzija. *Kineziologija*, 5 (1-2), 7-82.
- Katić, R., Grgantov, Z., & Jurko, D. (2006). Motor Structures in Female Volleyball Players Aged 14-17 According to Technique Quality and Performance. *Collegium Antropologicum*, 30 (1), 103-112.
- Milić, M., Grgantov, Z., & Katić, R. (2012). Biomotor status and kinesiological education of girls aged 10 to 12 years—example: volleyball. *Collegium Antropologicum*, 36(3), 959-966
- Morrow Jr, J.R., Hosler, W.W., & Nelson, J.K. (1980). A comparison of women intercollegiate basketball players, volleyball players and non-athletes. *The Journal of sports medicine and physical fitness*, 20(4), 435.
- Vuković, M., Krneta, Ž., Đurđić, B. i Simić, D. (2007). Usporedna analiza antropometrijskih i motoričkih varijabli učenica koje treniraju odbojku i učenica koje ne treniraju odbojku. U G. Bala (Ur.), *Zbornik radova interdisciplinarnе naučne konferencije sa međunarodnim učešćem "Antropološki status i fizička aktivnost dece i omladine"* (265-272). Novi Sad: Fakultet sporta i fizičkog vaspitanja.

Uticaj vežbi snage-tipa izdržljivosti i vežbi za razvoj skočnosti na agilnost kod mladih odbojkaša

Valdemar Štajer, Milan Vučinić, Aleksandar Karać,
Aleksandar Kotrljanović, Mario Roška

Fakultet sporta i fizičkog vaspitanja, Univerzitet u Novom Sadu, Srbija

ABSTRACT

The study was conducted on 19 male volleyball players ($17.47 \pm$ years; body height ± 1.91 m) cadet and junior selection from volleyball club "Vojvodina" Novi Sad. Volleyball players were subjected to a strength and conditioning training treatment for a period of eight weeks. During the duration of the treatment, there were two cycles per four weeks. Before and after the applied training treatment there were carried out tests of agility: modified T-test and Hexagon test. A statistically significant difference between initial and final measurements ($p < 0.05$) occurred in both examined variables. Statistically significant differences were in favor of the final measurement.

UVOD

Odbojka je sportska igra u kojoj dominantnu ulogu imaju tehnika i taktika. Cilj kondicioniranja u odbojci jeste razvoj eksplozivne snage i agilnosti, kao i razvoj specifične odbojkaške izdržljivosti (Foran, 2010). Sve su to motoričke sposobnosti potrebne da bi tehnički elementi koje igrači uvežbavaju tokom treniga, a primenjuju tokom prijateljskih i prvenstvenih mečeva bili na vrhunskom nivo izvođenja. Kondicioni trening zaseban za sebe ili kao dopunski deo treniga u odbojci zasniva se na primeni split treniga. Takav tip treniga omogućava organizmu da se oporavi od jedne vrste vežbi, dok sportista sprovodi druge vežbe (moguće i sa istim mišićnim grupama)(Foran, 2010). U pisanju istog autora Foran (2010) vežbe u odbojci se dele na dve osnovne grupe: vežbe za unapređenje snage i vežbe za razvoj agilnosti. Jedan od načina ispoljavanja snage predstavlja snaga-tipa izdržljivosti bolje rečeno „*repetativna snaga ili snažna izdržljivost*“. Vežbe koje se primenjuju predstavljaju sposobnost dugotrajnog rada koji ne premašuje

spoljašnje opterećenje veće od 75% od maksimuma, a spoljašnje opterećenje su u obliku tega ili partnera (Bjelica i Fratrić, 2011). Vežbe za razvoj skočnosti mogu se svrstati u grupu metoda za razvoj eksplozivne snage- „*elastično ili pliometrijskog karaktera*“ (Bjelica i Fratrić, 2011). Agilnost se manifestuje u nekoliko oblika: horizontalna promena pravca tela, vertikalna promena pravca, brzi pokreti određenih delova tela koji kontrolišu rekviziti u sportu (Foran, 2010). Kondicioni trening u odbojci deli se na dva osnovna tipa: kondicioni trening u toku sezone u trajnju između 35-45 minuta i kondicioni trening van sezone u trajanju između 90-120 minuta (Janković i saradnici, 2003). Bez obzira na kvalitativni nivo igrača, kondicioni trening treba da se zasniva na višezglobnim kompleksnim vežbama (Foran, 2010). Da bi mladi odbojkaši došli do izvođenja višezglobnih vežbi sa velikim opterećenjima na pravilan i bezbedan način potrebno imati jasan plan i program kroz koji će oni biti podvrgnuti adaptaciji na takve vežbe (Bompa, 1999). Cilj ovog istraživanja predstavlja utvrđivanje uticaja primenjenog dopunskog trenažnog tretman sprovedenog kroz vežbe snage - tipa izdržljivosti i skočnosti na razvoj motoričke sposobnosti - agilnosti kod mladih odbojkaša.

METOD RADA

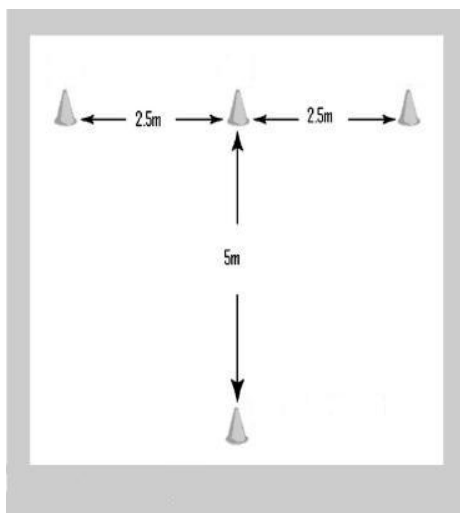

Uzorak ispitanika

Uzorak ispitanika je činilo 19 odbojkaša ($17,47 \pm$ godina starosti; telesne visine $1,91 \pm m$) kadeske i juniorske selekcije OK „Vojvodina“ iz Novog Sada.

Uzorak mernih instrumenata

U radu su primenjivani testovi za procenu agilnosti:

1. Modifikovan T-tets

Kako dimnzije odbojkaškog terena i prostorno krtanje samih odbojkaša je ralativno mala u prostoru smatrali smo da je prikladnije primeniti modifikovanu verziju standardnog T-testa za procenu frontalne i lateralne agilnosti kod odbojkaša (Sassi i saradnici, 2009). U modifikovanoj verziji T-testa ispitanik prelazi kraću distancu u testu naspram standardnog T-testa. Kretanje ispitanika u testu je u potpunosti zadržana kao u stnadradnom T-testu. Ispitanik treba za što kraće vreme da pređe zadatu distancu u testu, ima tri pokušaja i za svaki pokušaj se beleži vreme. Kao rezultat u testu se uzima naj bolje ostvareno vreme.

2. Heksagon test

Objekat interesovanja ovog testa je procena horizontalno-vertikalne agilnosti (Sudarov,2007; Sudarov i Fratrić, 2010)

Ispitanik treba za što kraće vreme da završi zadati broj preskakanja preko linija šestougona. Kao rezultat testa se uzima srednje vreme od tri pokušaja, za svaki pokušaj se beleži vreme.

Protokol relaizacije istraživanja

Na početku istraživanja izvršeno je inicijalno merenje i krenulo se u realizaciju tretmana, koji je sproveden u trajanju od osam nedelja, od 4 do 5 treninga nedeljno (ponedeljak,utorak, sreda, petak, subota) u zavisnosti od termina odigravanja utakmice. Nakon završetka tretmana izvršeno je finalno merenje svih ispitanika. Tretmanskim sadržajem je spovedeno tokom prolećnog dela savezne lige za kadete i juniore sezona 2014/2015 godine.

Tretman

U ovom istraživanju tretmaniski sadržaj se sastojao od:

1. Vežbe za razvoj Snage-tipa Mišićne izdržljivosti (Prilog 1.)

Opterećenje je bilo dozirano za svaku nedelju brojem serija i brojem ponavljanja. Same vežbe su bile podeljene u dve gupe Opšte vežbe i Specifične vežbe po tri treniga sa po četiri do osam vežbi. One su izdelfene u vežbe za donji deo tela, vežbe za gotnji deo tela i kombinaciju gornjeg i donjeg dela tela.

2. Vežbe za razvoj skočnosti (Prilog 1.)

Opterećenje je bilo dozirano prema nedeljama i uključivanje broja vežbi tokom nedelja se menjalo.

Sve vežbe su se sprovodile pre početka glavnog odbojkaškog treninga, a posle zagrevanja u trajanju između 35 i 45 minuta.

Tokom trajanja tretmana postojala su dva ciklusa po četiri nedelje. Prvi ciklusu je sadržao opšte vežbe za razvoj lokalne mišićne izdržljivosti sa tri treniga nedeljno i vežbe skočnosti sa dva treninga nedeljno u zavisnosti od utakmice. A tokom drugog ciklusa opšte vežbe zamenjene su specifičnim vežbama dok su vežbe za razvoj skočnosti se sprovodile po predviđenom nedeljnom planu.

Tabela 1. Raspored tretmanskih vežbi tokom radne nedelje

CIKLUS	PONEDELJAK	UTORAK	SREDA	ČETVRTAK	PETAK	SUBOTA	NEDELJA
PRVI (prve 4 nedelje)	Opšte vežbe 1	Vežbe skočnosti	Opšte vežbe 2	Odmor	Opšte vežbe 3	Vežbe skočnosti	
DRUGI (druge 4 ndelje)	Specifič- ne vežbe 1	Vežbe skočnosti	Specifične vežbe 2	Odmor	Specifične vežbe 3	Vežbe skočnosti	

Metode obrade podataka

Primenom Paired Samples T-testa utvrđene su razlike između inicijalnog i finalnog merenja u ispitivanim varijablama na nivou zaključivanja statističke značajnost ($p < 0,01$). Pouzdanost modifikovanog T-testa je bila urađena korišćenjem Cronbach-ovog alfa koeficijenta za pouzdanost na inicijalnom i na finalnom merenju.

REZULTATI

Nakon primenjenog trenažnog tretmana statistički značajna razlika kod odbojkaša između inicijalnog i finalnog merenja ($p < 0,05$) javila se kod obe ispitivane varijable. Statistički značajne razlike su u korist finalnog merenja (Tabela 2).

Tabela 2. Rezultati Paired Samples T-testa na ispitivanim varijablama

		AS	r	t	p
Modifikovan T-tets	1	6,23	0,73*	3,731	0,02*
	2	6,01			
Heksagon test	1	12,78	-0,02	10,202	0,00*
	2	9,74			

Legenda: AS- aritmetička sredina; t – vrednost T-testa; p- statistička značajnost;

1- inicijalno merenje; 2- finalno merenje

* Statistički značajna razlika na nivou $p < 0,05$ između inicijalnog i finalnog merenja

Cronbach-ov Alfa koeficijent za pouzdanost Modifikovanog T-test na nivou značajnosti od $p=0,05$ je pokazao sledeće rezultate: Standardized item alpha iznosio je 0.946 na inicijalnom i na finalnom 0.943 testiranju.

DISKUSIJA I ZAKLJUČAK

Primenjeni modifikovani T-test poseduje pouzdanost za procenu agilnosti kod ove grupe odbojakaša. Sassi i saradnici (2009) na uzorku od 86 ispitanika oba pola (34 ženskog pola i 52 muškog pola) su procenili da modifikovani T-test poseduje visoku pouzdanost svog polja merenja, a pokazao je i veliku pozitivnu korelaciju sa standardnim T-testom. Svakako postoji prostor da se ovako modifikovani T-test za procenu agilnosti kod mladih odbojkaša uvrsti u standardne baterije testova pri testiranju, a ujedno da posluži i za selekciju samih igrača u tim (Gabbett i saradnici, 2007). Za tako nešto potrebno je izvršiti još testiranja na većem uzorku ispitanika. Koordinacija i agilnost predstavljaju ključni faktori na osnovu kojih treneri, ali i gledaoci procenjuju ko je pravi sportista u datom momentu igre (Foran, 2010). Miller, Herniman, Ricard, Christopher, i Michael (2006) su testirali kakve će efekte dati šestonedeljni pilometrski trening na ispoljavanje agilnost kod mlađih sporsitista. Efekti primene vežbi pliometrijskog karaktera su dali pozitivne rezutate. Međutim, treba uzeti u obzir i činjenice da na ispoljavanje agilnosti kao motoričke sposobnosti uticaj ima i niz drugih faktora koji nju čine celinom (Foran, 2010; Sassi i saradnici, 2009). Svakako da je tretmanski sadržaj doprineo rezultatima kod ove grupe ispitanika, ali se sa sigurnošću ne može tvrditi da je primenjeni tretmanski sadržaj pogodan za korišćenje za generalnu populaciju tog uzrasta odbojkaša. Treneri u mlađim uzrasnim kategorijama imaju vrlo odgovoran zadatak da mlade sportiste izvedu do seniorske selekcije. Na tom putu

planiranim i programiranim treningom efekati tih treninga imaju veliki uticaj u dugogodišnjoj pripremi mladih spostista za seniorski uzrast. Radovnim testiranjima, retestiranjima novih ili dopunjenih trenažnih tretmana treneri dobijaju bolji uvid u formu kojom njihovi takmičari izlaze na takmičarski teren i efekti predhodno minulog rada se valorizuju tim putem.

LITERATURA

Bompa, T.O. (1999). *Periodization. Theory and Methodology of Training*. Champaign, Ill: Human Kinetics.

Bjelica, D. i Fratrić, F. (2011). *Sportski Trening-teorija, metodika i dijagnostika*. Nikšić: Fakultet za sport i fizičko vaspitanje. Nikšić, Crnogorska sportska akademija iz Podgorice.

Foran, B. (2010). *Vrhunski kondicioni trening*. Beograd, Datastatus.

Miller, M. G., Herniman, J. J., Ricard, M. D., Christopher, C., & Michael, T. J. (2006). Research article THE EFFECTS OF A 6-WEEK PLYOMETRIC TRAINING PROGRAM ON AGILITY. *Journal of Sports Science and Medicine*, 5, 459–465.

Gabbett, T., Georgieff, B., & Domrow, N. (2007). The use of physiological, anthropometric, and skill data to predict selection in a talent-identified junior volleyball squad. *Journal of Sports Sciences*, 25(12), 1337–44.

Sassi, R.H., Dardori, W., Yahmed, M.H., Gmada, N., Mahfoudhi, M.E. I Gharbi, Z. (2009). Relative and absolute reliability of a modified agility T-test and its relationship with vertical jump and straight sprint. *Journal of Strength and Conditioning Research*, 23(6), 1644–1651.

Sudarov, N. (2007). *Testovi za procenu fizičkih performansi*. Novi Sad: Pokrajinski zavod za sport.

Sudarov, N., Fratrić, F. (2010). *Dijagnostika treniranosti sportista*. Novi Sad: Pokrajinski zavod za sport.

Janković, V., Janković, G., Đurković, T. (2003). Specifična fizička priprema vrhunskih odbojkaša, U: D. Milanović i I. Jukić (ur.), *Kondicijska priprema sportaša*, Zbornik radova međunarodnog znanstveno-stručni skupa, Zagreb, 21. i 22. veljače 2003., str. 442-450. Zagreb: Kineziološki fakultet Sveučilišta u Zagrebu; Zagrebački športski savez.

The impact of a programmed football training on functional abilities among young players

Šime Buzov¹, Alen Gavranić¹, Petra Mandić Jelaska²

¹F.C. "Val" - Kaštel Stari, ²Faculty of Kinesiology, Split, Croatia

ABSTRACT

The main problem of this research was to analyze the changes in functional abilities of young football players under the influence of programmed and specific football training. In accordance with the aim a sample of 16 young cadet players was used. All subjects were training under the same curriculum for four microcycles with total duration of four weeks. Subjects were measured initially and finally in the following variables: *body height, body mass, thigh circumference, long jump from a standstill, number of sit-ups in 60 seconds, number of push-ups in 30 seconds, Cooper test and 300 yards test*. The difference between initial and final measurement was established by using the t-test for paired samples. Although control group was missing, results indicate that programmed football treatment applied on football players can be considered as effective tool for the functional development among young players.

Keywords: football, microcycle, programmed treatment, functional abilities.

INTRODUCTION

Today, football is one of the most popular sports all over the globe. The great rise in its popularity, that has occur in the past twenty years, has made a great impact on its complexity, especially on the demands of fitness, technical, tactical and psychological preparation of a player (Lehance, Binet, Bury, & Croisier, 2009). Increasing demands on the players is mainly in the area of fitness training (Boone, Deprez, & Bourgois, 2014), which is one of the most important factors of success in football (Burgess, Naughton, & Norton, 2006; Carling, 2013; Carling, Le Gall, & Dupont, 2012). The most important

part is running medium and high intensity if we look in dominant structures of motion (Barnes, Archer, Hogg, Bush, & Bradley, 2014; Burgess et al., 2006). Also, modern football players must have very high degree of functional skills. The outcome of high level training is increasing number of injuries (Brito et al., 2011; Greig & Walker-Johnson, 2007; Lehance et al., 2009).

All players have different energy capacities and different level of their use in complex and turbulent situations of football game. Knowing these characteristics in football teams is a base for planning and programming training if functional skills (Alexandre et al., 2012; de Hoyo et al., 2015). First step in planning is diagnostic. Diagnostics of functional abilities are performed as initial and final measurement during the training process in order to determine the effectiveness of aerobic and anaerobic functioning mechanisms or control the effects that the programmed training has achieved (Castagna, Abt, & D'Ottavio, 2002; Rudroff, 2003). With the diagnostic results, football players get a detail insight into the current state of training, which allows control over the training process and also helps to get a closer look in the current physical condition (Chamari et al., 2004; Geyer, Sanderbeuermann, Wegner, & Wirth, 1993). Although there are prominent practical and scientific issues, there are not many studies of the training structure among young age categories (Milanovic et al., 2014).

The main problem of this study is to analyze the changes in functional abilities of young players under the influence of programmed and specific football training. The goal is to show that with programmed treatment applied on football players we can affect the functional development.

METHODS

In this study, a sample of respondents consisted of 16 cadet players of F.C. "Val" from Kaštel Stari, with the average age of 15,7 years. All subjects were training under the same curriculum for four microcycles with total duration of four weeks. Measurements were carried out at the field of the club, with the help of highly coordinated and trained associates.

In tables 1, 2, 3 and 4 programs of four microcycle trainings are shown for cadets from F.C. "Val" in their preparatory period. All trainings occur at the same time. The duration of training was approximately seventy five minutes (from 03:00 PM to 04:15 PM).

Table 1. Content of the first training microcycle.

Day	Structure of training	Intensity
Mon	Warming-up + work on balance and joint stability (20 min). Mechanics of movement training (15 min). The technical and tactical training (20 min). Aerobic training of moderate intensity (20 min).	Medium
Tue	Warming-up + work on balance and joint stability (18 min). Speed and agility training (15 min). Muscular endurance training (30 min). Playing football (15 min).	High
Wed	Active rest.	
Thu	Warming-up + work on balance and joint stability (15 min). Mechanics of movement training (15 min). High intensity aerobic training (15 min). Aerobic training of moderate intensity (10 min). Muscular endurance training (20 min).	High
Fri	Warming-up + work on balance and joint stability (15 min). Strength training: maximal strength and explosive strength (30 min). The technical and tactical training (30 min).	Medium
Sat	Friendly match.	High
Sun	Rest.	

Table 2. Content of the second training microcycle.

Day	Structure of training	Intensity
Mon	Warming-up + work on balance and joint stability (15 min). Maximal and explosive strength training (30 min). Playing football (25 min).	High
Tue	Warming-up + the technical and tactical training (25 min). Speed and agility training (15 min). Endurance in speed training (10 min). Aerobic training of moderate intensity (20 min)	Medium
Wed	Active rest.	
Thu	Warming-up + work on balance and joint stability (15 min). Maximal strength and muscular endurance training (25 min). The technical and tactical training (20 min). Playing football (20 min).	High
Fri	Warming-up + work on balance and joint stability (15 min). Speed and agility training combined with explosive strength training (20 min). The technical and tactical training (30 min). High intensity aerobic training (15 min).	Medium
Sat	Friendly match.	High
Sun	Rest.	

Table 3. Content of the third training microcycle.

Day	Structure of training	Intensity
Mon	Warming-up + work on balance and joint stability (20 min). The technical and tactical training (20 min). High intensity aerobic training (20 min). Playing football (20 min).	High
Tue	Warming-up + work on balance and joint stability (18 min). Speed and agility training (15 min). Muscular endurance training (30 min). Playing football (15 min).	Medium
Wed	Active rest.	
Thu	Warming-up + the technical and tactical training (25 min). Speed and agility training (20 min). Endurance in speed training (15 min). High intensity aerobic training (25 min).	High
Fri	Warming-up + work on balance and joint stability (15 min). The technical and tactical training (20 min). Playing football (25 min).	Medium
Sat	Friendly match.	High
Sun	Rest.	

Table 4. Content of the fourth training microcycle.

Day	Structure of training	Intensity
Mon	Warming-up + work on balance and joint stability (15 min). The technical and tactical training (20 min). High intensity aerobic training (20 min). Playing football (15 min).	High
Tue	Warming-up + work on balance and joint stability (15 min). Speed and agility training combined with explosive strength training (20 min). The technical and tactical training (30 min).	Medium
Wed	Active rest.	
Thu	Warming-up + work on balance and joint stability (15 min). The technical and tactical training (30 min). High intensity aerobic training (15 min). Playing football (15 min).	High
Fri	Warming-up (15 min). Speed and agility training combined with explosive strength training (20 min). The technical and tactical training (20 min). Endurance in speed training (15 min).	Medium
Sat	Friendly match.	High
Sun	Rest.	

Qualitative and quantitative transformation effects are achieved with proper dose of training (Mandić Jelaska, 2012). From table 1-4 we can

see that during the preparatory period, the focus was on aerobic training with high intensity. Aerobic training of high intensity or the real situations during the match reduces heart rate in physical exertion. Another reason for this specific practice is that the target muscle group reaches the possibility of absorbing larger amounts of carbohydrates, which are an essential source of energy in anaerobic work. Technical and tactical training is also important because of the real situations in the football game. With speed and agility training, combined with training of explosive strength, goal was to achieve a greater anaerobic capacity, which is essential in modern football. Balance and joints stability work is very important for the prevention of injuries.

Subjects were measured in the following variables: body height (BH) [cm], body mass (BM) [kg], thigh circumference (TC) [cm], long jump from a standstill (LJSS) [cm], number of sit-ups in 60 seconds (STU) [the number of repetitions], the number of push-ups in 30 seconds (NPUS) [the number of repetitions], Cooper test (COOP) [m] and 300 yards test (300Y) [sec].

Descriptive statistics parameters were calculated for all variables: arithmetic mean (M), standard deviation (σ), minimum (Min) and maximum (Max) value. The difference between initial and final measurement was established by using the t-test for paired samples. Using the formula:

$$r^2 = \frac{t^2}{t^2 + df}$$

parameter of effect size is calculated as amount of variability of the dependent variable which is due to used programmed treatment. Kolmogorov-Smirnov test was used for normality testing.

RESULTS AND DISCUSSION

Results of Kolmogorov-Smirnov test indicates that in both measurements none of the variables had distribution for which it can be concluded that it deviates from normal. In table five, there are descriptive statistical parameters, results of t-test for paired samples and effect size parameter.

Table 5. Descriptive statistical parameters initial and final measurement results of t-test for independent samples and effect size: arithmetic mean \pm standard deviation ($M\pm\sigma$), minimal result (Min), maximal result (Max), test value (t), level of significance (p) and effect size (r^2).

Variable	Initial measurement			Final measurement			t	p	r^2
	$M\pm\sigma$	Min	Max	$M\pm\sigma$	Min	Max			
BH	177,44±8,16	166	192	177,44±8,16	166	192	---	---	---
BM	70,30±10,82	55,00	88,80	69,75±10,57	54,70	87,30	3,40	0,004	0,44
TC	53,73±3,10	49,70	59,70	53,71±3,07	49,60	59,70	0,76	0,456	0,04
COOP	2640,63±110,78	2470	2830	2811,25±137,35	2600	3080	-8,25	0,000	0,82
LJSS	207,81±13,54	185	240	208,75±13,47	188	240	-3,76	0,002	0,49
STU	46,63±7,57	35	62	52,81±8,19	40	68	-12,76	0,000	0,92
NPUS	30,19±5,48	22	41	32,88±5,76	26	47	-7,67	0,000	0,80
300Y	73,06	63,00	86,00	66,38±6,57	57,00	80,00	13,22	0,000	0,92

From t-test results (table 5) we can see statistically significant increase in ability of athletes. The same applies to the minimum and maximum values of motor skills. The results are consistent with other studies, which show the influence of football practice on the quality of football performance (Nicks, Morgan, Fuller, & Caputo, 2009), motor development (Erceg, Zagorac, & Katic, 2008) and also on immune system (Rebelo et al., 1998). Studies show an association between variable of functional status with the quality of performance in football (Castagna et al., 2002).

As expected, it can be seen that significant progress in all variables except variable BH and TC. In variable TC, the lack of the effect is result of small number of training sessions. From parameter effect size it can be seen that large amount of variability can be attributed to the programmed treatment. Although small in absolute sense, statistically significant differences appeared in variables BM (70,30 vs 69,75) and LJSS (207,81 vs 208,75).

At closer look in results, finally it can be concluded that the programmed treatment of football in period of four microcycle probably influenced the changes in functional abilities and aerobic and anaerobic endurance the most. It's because the training structure had an emphasis on the development of functional abilities so, the progress was achieved.

Many research have been done with the goal of identification of soccer training effectiveness. Consequently, in order to do systematical summarization of the evidences on the effectiveness of proprioceptive training in reducing

the incidence and recurrence rates of ankle sprains in the sporting population a systematic review and meta-analysis of randomised controlled trials was done (Schiftan, Ross, & Hahne, 2015). Conclusion is that proprioceptive training programmes are effective at reducing the rate of ankle sprains in sporting participants, particularly those with a history of ankle sprain. Also positive effects of neuromuscular training are topics of recent scientific and practical interest (Crowcroft et al., 2015; Simola et al., 2015; Stevenson, Beattie, Schwartz, & Busconi, 2015; Uth et al., 2014; Wells, Edwards, Fysh, & Drust, 2014). Researches indicate that SAQ training may be more effective for improving sprint performance for some soccer players but more research is required to determine ideal training methods for improving acceleration and flexibility in young soccer players. (Milanovic et al., 2014)

CONCLUSION

With this study we attempted to determine the effectiveness of the programmed and specific football treatment in the preparatory period and changes in functional motor skills in cadet level players. Five functional motor tests were applied on respondents for two times in the period of four weeks. Dimensions of speed, explosive strength, repetitive strength and endurance were estimated. Also three tests of morphological traits were applied. The results clearly indicate that in the period between the initial and final measurement changes have been made in all variables of functional motor skills. It has turned out that the programmed football treatment with regular curriculum training favorably influences the development of aerobic and anaerobic endurance, speed and various manifestation of strength.

Limitation of this study is the lack of a control group. Specifically, in a given study we can't speak about the final effects of the training without doubts, simply because of the saturation with other uncontrollable factors. In future studies of this type, with the use of a control group of subjects, it would be also appropriate to increase the sample size, and observe other age groups of players, but also make measurement at several time points.

REFERENCES

Alexandre, D., da Silva, C. D., Hill-Haas, S., Wong, D. P., Natali, A. J., de Lima, J. R. P., . . . Karim, C. (2012). Heart Rate Monitoring in Soccer: Interest and Limits during Competitive Match Play and Training, Practical Application. *Journal of Strength and Conditioning Research*, 26(10), 2890-2906.

Barnes, C., Archer, D. T., Hogg, B., Bush, M., & Bradley, P. S. (2014). The Evolution of Physical and Technical Performance Parameters in the English Premier League. *International Journal of Sports Medicine*, 35(13), 1095-1100. doi: DOI 10.1055/s-0034-1375695

Boone, J., Deprez, D., & Bourgois, J. (2014). Running economy in elite soccer and basketball players: differences among positions on the field. *International Journal of Performance Analysis in Sport*, 14(3), 775-787.

Brito, J., Rebelo, A., Soares, J. M., Seabra, A., Krustup, P., & Malina, R. M. (2011). Injuries in Youth Soccer During the Preseason. *Clinical Journal of Sport Medicine*, 21(3), 259-260. doi: Doi 10.1097/Jsm.0b013e31821a6025

Burgess, D. J., Naughton, G., & Norton, K. I. (2006). Profile of movement demands of national football players in Australia. *Journal of Science and Medicine in Sport*, 9(4), 334-341. doi: DOI 10.1016/j.jsams.2006.01.005

Carling, C. (2013). Interpreting Physical Performance in Professional Soccer Match-Play: Should We be More Pragmatic in Our Approach? *Sports Medicine*, 43(8), 655-663. doi: DOI 10.1007/s40279-013-0055-8

Carling, C., Le Gall, F., & Dupont, G. (2012). Analysis of repeated high-intensity running performance in professional soccer. *Journal of Sports Sciences*, 30(4), 325-336. doi: Doi 10.1080/02640414.2011.652655

Castagna, C., Abt, G., & D'Ottavio, S. (2002). Relation between fitness tests and match performance in elite Italian soccer referees. *Journal of Strength and Conditioning Research*, 16(2), 231-235.

Chamari, K., Hachana, Y., Ahmed, Y. B., Galy, O., Sghaier, F., Chatard, J. C., . . . Wisloff, U. (2004). Field and laboratory testing in young elite soccer players. *British Journal of Sports Medicine*, 38(2), 191-196. doi: 10.1136/bjism.2003.004374

Crowcroft, S., Duffield, R., McCleave, E., Slattery, K., Wallace, L. K., & Coutts, A. J. (2015). Monitoring training to assess changes in fitness and fatigue: The effects of training in heat and hypoxia. *Scandinavian Journal of Medicine & Science in Sports*, 25, 287-295. doi: Doi 10.1111/Sms.12364

de Hoyo, M., de la Torre, A., Pradas, F., Sanudo, B., Carrasco, L., Mateo-Cortes, J., . . . Gonzalo-Skok, O. (2015). Effects of Eccentric Overload Bout on Change of Direction and Performance in Soccer Players. *International Journal of Sports Medicine*, 36(4), 308-314. doi: DOI 10.1055/s-0034-1395521

Erceg, M., Zagorac, N., & Katic, R. (2008). The impact of football training on motor development in male children. *Coll Antropol*, 32(1), 241-247.

Geyer, M., Sanderbeuermann, A., Wegner, U., & Wirth, C. J. (1993). Stress Reactions and Stress-Fractures in High-Performance Athletes - Causes, Diagnosis and Therapy. *Unfallchirurg*, 96(2), 66-74.

Greig, M., & Walker-Johnson, C. (2007). The influence of soccer-specific fatigue on functional stability. *Physical Therapy in Sport*, 8(4), 185-190. doi: DOI 10.1016/j.ptsp.2007.03.001

Lehance, C., Binet, J., Bury, T., & Croisier, J. L. (2009). Muscular strength, functional performances and injury risk in professional and junior elite soccer players. *Scandinavian Journal of Medicine & Science in Sports*, 19(2), 243-251. doi: DOI 10.1111/j.1600-0838.2008.00780.x

Mandić Jelaska, P., Kuvačić, G., Valušek, A. (2012). *Utjecaj specifičnog tretmana na motoričko-funkcionalne sposobnosti nogometašica ŽNK „Dinamo Maksimir“* Paper presented at the Kondicijska priprema sportaša – Specifična kondicijska priprema, Zagreb.

Milanovic, Z., Sporis, G., Trajkovic, N., Sekulic, D., James, N., & Vuckovic, G. (2014). Does SAQ training improve the speed and flexibility of young soccer players? A randomized controlled trial. *Human Movement Science*, 38, 197-208. doi: DOI 10.1016/j.humov.2014.09.005

Nicks, C. R., Morgan, D. W., Fuller, D. K., & Caputo, J. L. (2009). The Influence of Respiratory Muscle Training Upon Intermittent Exercise Performance. *International Journal of Sports Medicine*, 30(1), 16-21. doi: DOI 10.1055/s-2008-1038794

Rebelo, A. N., Candeias, J. R., Fraga, M. M., Duarte, J. A., Soares, J. M., Magalhaes, C., & Torrinha, J. A. (1998). The impact of soccer training on the immune system. *J Sports Med Phys Fitness*, 38(3), 258-261.

Rudroff, T. (2003). Functional capability is enhanced with semitendinosus than patellar tendon ACL repair. *Medicine and Science in Sports and Exercise*, 35(9), 1486-1492. doi: Doi 10.1249/01.Mss.0000084425.07852.7d

Schiftan, G. S., Ross, L. A., & Hahne, A. J. (2015). The effectiveness of proprioceptive training in preventing ankle sprains in sporting populations: A systematic review and meta-analysis. *Journal of Science and Medicine in Sport*, 18(3), 238-244. doi: DOI 10.1016/j.jsams.2014.04.005

Simola, R. A. D., Harms, N., Raeder, C., Kellmann, M., Meyer, T., Pfeiffer, M., & Ferrauti, A. (2015). Assessment of Neuromuscular Function after Different Strength Training Protocols Using Tensiomyography. *Journal of Strength and Conditioning Research*, 29(5), 1339-1348.

Stevenson, J. H., Beattie, C. S., Schwartz, J. B., & Busconi, B. D. (2015). Assessing the Effectiveness of Neuromuscular Training Programs in Reducing the Incidence of Anterior Cruciate Ligament Injuries in Female Athletes A Systematic Review. *American Journal of Sports Medicine*, 43(2), 482-490. doi: Doi 10.1177/0363546514523388

Uth, J., Hornstrup, T., Schmidt, J. F., Christensen, J. F., Frandsen, C., Christensen, K. B., . . . Krstrup, P. (2014). Football training improves lean body mass in men with prostate cancer undergoing androgen deprivation therapy. *Scandinavian Journal of Medicine & Science in Sports*, 24, 105-112. doi: Doi 10.1111/Sms.12260

Wells, C., Edwards, A., Fysh, M., & Drust, B. (2014). Effects of high-intensity running training on soccer-specific fitness in professional male players. *Applied Physiology Nutrition and Metabolism-Physiologie Appliquee Nutrition Et Metabolisme*, 39(7), 763-769. doi: DOI 10.1139/apnm-2013-0199

Konstrukcija i inicijalna validacija upitnika Plivačke kompetencije i angažiranosti

Boris Milavić, Boris Maleš, Dražen Guć

Kineziološki fakultet, Sveučilište u Splitu, Hrvatska

ABSTRACT

The aim of this study was to construct and initially validate scales of the swimming competence and swimming engagement of the sailors. For that purpose 51 sailors were given a 27 items questionnaire, and their swimming achievement was measured with on a *50 meters freestyle swimming test*. Three scales of swimming competence were constructed (*swimming competence; rescuing competence; swimming styles*) and a scale of *swimming engagement*, all with a good metric characteristics. Results of the three scales of swimming styles represent the facets of the *general swimming competence*. A set of predictor variables that was compound from the newly constructed scales makes a significant prediction of the swimming achievement of sailors. Furthermore, significant partial contribution of the variable *swimming styles* on the swimming achievement of the sailors was established. Applying constructed scales is making possible only a "rough" categorization of the swimming achievement of the sailors and it's justified to use it only if it's not possible to conduct a real swimming achievement test. It's recommended to continue further researches of the relations between constructed scales of the swimming competence and the swimming engagement with a different types of swimming motor skills that are important for the Navy (for example: swimming while clothed, rescuing a drowning man, diving, performance of other surface and/or underwater naval activities).

Key words: perceived competence, swimming, sailors, swimming styles

UVOD

Poznavanje vještine ili znanja plivanja je za čovjeka od egzistencijalnog značenja (Zahorjević, 1982). Znanje plivanja kao jedno od temeljnih ljudskih

znanja oduvijek je privlačilo pozornost ljudske populacije. Neki znanstvenici ga svrstavaju u temeljna ljudska znanja po važnosti kao što su to hodanje i disanje jer čovjek kao biće antropološki nije prilagođen za kretanje kroz vodu kao ni po samoj vodi. *Svjetska zdravstvena federacija* (eng. *World Health Organization*, 2014) u svom službenom godišnjem izvješću navodi kako se svake godine u svijetu utopi 370 000 ljudi, preko 50 % od ukupnog broja utopljenih su osobe mlađe od 25 godina, a treći je uzrok smrtnosti za djecu dobi do 15 godina. *Međunarodna federacija za spašavanje*, (eng. *International Life Saving Federation*, 2011) na svojoj službenoj mrežnoj stranici navodi kako od broja utopljene djece otprilike 8 do 10 puta više djece iskusi utapanje, ali se sami spase ili ih spase druge osobe. Najčešće se utapanje pojavljuje u tri dobne kategorije: 0 do 5 godina, 20 do 25 godina te 60 i više godina. Jedna četvrtina žrtava utapanja bili su plivači te navode kako će čak i onima koji znaju plivati moguće biti potrebne dopunske vještine preživljavanja zbog toga što: osoba neće moći plivati nakon pada s broda ili pak dugotrajnog plivanja; nekoga može nositi jaka morska struja; mogu se pojaviti neočekivane okolnosti poput grča mišića ili nemogućnosti plivanja zbog vrlo hladne vode; i pješak može pasti s pristaništa ili lukobrana ili pak biti odvučen od obale u more velikim valom. Brojčane vrijednosti o utopljenim osobama vrlo se razlikuju od države do države, a prema *Godišnjem izvješću o utapanjima za 2007. godinu* (ILSF, 2007), navode se brojke utopljenika na 100.000 državljana između 3,4 za Finsku, 2,4 za Češku, 2,1 za Bugarsku do 0,8 za Njemačku i 0,6 za Veliku Britaniju. Razlike među državama svijeta pojavljuju se zbog više razloga: u nekim državama vrlo malo osoba nauči plivati; neke države imaju veći broj prirodnih nepogoda pa se velik broj osoba neočekivano nađe u situaciji vodene opasnosti. Mada za Republiku Hrvatsku nema navedenih podataka o brojnosti utopljenih osoba, u medijima se svakodnevno navode podaci o velikoj brojnosti utopljenika, kako stranih državljana, tako i hrvatskih državljana. Razlozi za to su, kao i uvijek, subjektivne i objektivne prirode. Činjenica je da Hrvatska nema dovoljan broj bazena (posebice zatvorenih), a i postojeći bazeni nisu optimalno lokacijski disperzirani, već su smješteni u većim gradovima (u nekima i po nekoliko). Međutim, po objektivnom mišljenju mnogih stručnjaka iz područja zdravstva, obrazovanja i kineziologije, pravi razlog velikog broja utopljenika u RH ne nalazi se u broju bazena, već u nesustavnom pristupu učenju znanja plivanja, od strane obrazovnih ustanova. Findak (1999) navodi kako je u obrazovnim planovima i programima u osnovnim školama jedna od prioritarnih obrazovno – kinezioloških zadaća u nastavi TZK, savladavanje vještine plivanja od strane

učenika. Kao razlozi za neprovođenje ove zadaće u praksi, koja je za čovjeka od utilitarnog značenja, najčešće se navode organizacijsko-logistički problemi.

Harter je (1978, prema Cox, 2005) predložio teoriju motivacije za postignuće u sportu čija je osnova doživljaj osobne kompetentnosti pojedinca, a u kojoj navodi kako je svaki je pojedinac prirodno motiviran za stjecanje sposobnosti u svim područjima ljudskog djelovanja, pa tako i u sportu. Kako bi osoba zadovoljila svoju potrebu za postignućem ona pokušava savladati pojedinu vještinu, a ostvarenje uspjeha prilikom tih pokušaja razvija doživljaj pozitivnog ili negativnog afekta. Uspješni pokušaji podražavaju osjećaj samoefikasnosti i osobne kompetencije koji nadalje pojačavaju *kompetencijsku motivaciju*, a njenim jačanjem osoba je još više potaknuta savladavati nove vještine. Stav o osobnim sportskim mogućnostima, a utemeljen na subjektivnim iskustvima svakog pojedinca za sebe, nazivamo *percipirana sportska kompetencija*. Sportska kompetencija u pojedinca može biti opća ili specifična (Milavić, Guć i Miletić, 2010) te može biti vrlo pozitivno izražena u jednom području djelovanja (primjerice u sportskoj igri), a istodobno negativno izražena u drugom kineziološkom području (primjerice u plivanju). Milavić, Guć i Miletić (2010) su na populaciji učenika dva završna razreda osnovne škole konstruirali ljestvice opće i specifične percipirane sportske kompetencije. Ljestvice su homogene i osjetljive. Na česticama *opće PSK* procjenjuju se mogućnosti pojedinca u odnosu na sport općenito, kao i u sportskoj uspješnosti pojedinca u odnosu prema drugima učenicima. Na česticama *specifične PSK* procjenjuju se mogućnosti pojedinca, ali u znatno užim i specifičnijim područjima sporta i tjelesnih aktivnosti (izdržljivost, snaga, sportska igra, fleksibilnost, koordinacija).

Važnost znanja plivanja u *oružanim snagama* može se sagledati na dva načina: prvo, znanje plivanja kao esencijalna ljudska vještina (utilitarno znanje); drugo, znanje plivanja kao element bojne spremnosti svakog pripadnika oružanih snaga. Neovisno o tome kako je stečeno znanje plivanja i kolika je plivačka angažiranost pojedinca, svatko od osoba razvio je i specifičnu kompetenciju povezanu s plivanjem, a koju se preporuča nazvati *plivačkom kompetencijom*. Guć, Vuković i Maleš (2007) u svom su radu istraživali povezanost između nekih funkcionalno – motoričkih sposobnosti i uspjeha u plivanju na 25 m i 50 m, na uzorku 58 ročnih vojnika/mornara HRM. Za procjenu funkcionalno-motoričkih sposobnosti primijenjen je skup od 14 testova za procjenu repetitivne i eksplozivne snage te aerobne i anaerobne izdržljivosti. Rezultati istraživanja pokazali su da je primjenjenim funkcionalno-

motoričkim varijablama moguće predvidjeti uspjeh u plivanju na 25 m i 50 m. Najveću prediktivnu vrijednost pokazali su testovi repetitivne snage gornjih ekstremiteta, što je direktno povezano sa samom izvedbom (mehanicom) plivanja kraul tehnikom. Oružane snage su «posljednja» državna institucija u kojoj se na sustavan način može, barem djelomično pokušati riješiti ovaj problem, ali samo s pripadnicima oružanih snaga.

Cilj ovog rada je konstrukcija i inicijalna validacija mjernih instrumenata za mjerenje plivačke kompetencije i plivačke angažiranosti te utvrđivanje relacija između konstruiranih mjera s plivačkom učinkovitosti kod mornara.

METODE

Uzorak ispitanika sačinjavali su 51 djelatni mornar iz sastava postrojbi HRM, ispitanika u sastavu projekta «Istraživanje ljudskih resursa» kojeg je provodio Kineziološki fakultet u Zagrebu. Za utvrđivanje plivačke kompetencije i angažiranosti konstruirane su nove mjerne ljestvice. U sklopu opsežnijeg upitnika primjenjeno je 27 čestica Likertovog tipa kojima se ispituju različite procjene i manifestacije plivačke kompetencije i plivačke angažiranosti. Čestice su prilagođene za primjenu na populaciji mornara i odnose se na procjenu osobne kompetencije plivanja u idealnim ili otežanim uvjetima (dužina ili trajanje plivanja), procjene znanja različitih plivačkih stilova te osobne angažiranosti mornara u plivanju. Kondenzacija ukupnih rezultata na ljestvicama izvršena je metodom jednostavnog zbrajanja, a nakon toga je ta vrijednost podijeljena s brojem čestica u ljestvici, kako bi se rezultati različitih ljestvica s različitim brojem čestica mogli uspoređivati. U cilju utvrđivanja plivačke uspješnosti mornara korišten je standardizirani test *plivanje 50 m slobodno*, a mjerenje plivačkog testa provedeno je u 25 m bazenu u kontroliranim uvjetima temperature vode. Sukladno postavljenom cilju istraživanja korišteni su postupci obrade prikupljenih podataka za utvrđivanje metrijskih karakteristika za konstruiranje ljestvica (pouzdanosti, homogenosti, osjetljivosti i faktorske valjanosti). Pragmatična valjanost *konstruiranih ljestvica* utvrđena je postupcima deskriptivne statistike, korelacijske analize i multiple regresije s varijablom plivačke uspješnosti kao kriterijskom varijablom i varijablama *plivačke kompetencije i angažiranosti* kao skupom prediktora.

REZULTATI

U početnoj analizi čestica ljestvica *plivačke kompetencije* postupkom faktorske analize utvrđeno je kako su se čestice projicirale u 4 latentne dimenzije

te su potom konstruirane tri zasebne ljestvice *plivačkih kompetencija*. Ljestvica *plivačke kompetencije* (PLV_KOMP) ima šest čestica koje se odnose na opću plivačku kompetenciju – sposobnost dugog ili dugotrajnog plivanja po mirnom ili nemirnom moru. Ljestvica *kompetencije za spašavanje* (SPAS_KOMP) ima pet čestica koje se odnose na kompetenciju za spašavanje – odlučnost ispitanika za spašavanje utopljenika te sposobnost plivanja u odjeći ili po vrlo valovitom nemirnom moru – plivačke sposobnosti važne za mogućnost spašavanja. Ljestvica *plivački stil* (PLIV_STIL) ima šest čestica koje se odnose na poznavanje različitih plivačkih stilova i plivačkog okreta. Posebna ljestvica *plivačka angažiranost* (PLIV_ANG) ima pet čestica koje se odnose na angažiranost u plivanju – plivanje ljeti i zimi, te plivanje velikih ili dugih plivačkih dionica.

Tablica 1. Deskriptivna statistika mjerenih varijabli

Varijabla	AS	SD	α	% var	MIN	MAX	SKEW	KURT	D
PLV_KOMP	3.42	0.96	0.90	67%	1.50	5.00	-0.05	-0.99	0.09
SPAS_KOMP	3.56	0.68	0.80	57%	2.00	5.00	-0.09	0.10	0.14
PLIV_STIL	3.32	0.77	0.84	60%	1.50	4.83	-0.18	-0.16	0.09
PLIV_ANG	2.31	0.76	0.74	51%	1.20	3.80	0.33	-0.95	0.15
PLIVANJE 50 m	43.56	9.28	-	-	30.72	69.03	1.00	0.34	0.15

Legenda: AS – aritmetička sredina; SD – standardna devijacija; α – koeficijent pouzdanosti Cronbach alfa; % var – postotak faktorom objašnjene varijance; MIN – minimalni rezultat; MAX – maksimalni rezultat; SKEW – koeficijent simetričnosti distribucije rezultata; KURT – koeficijent oblika distribucije rezultata; D – vrijednost Kolmogorov-Smirnovljeva testa (granična vrijednost D= 0.19).

Mjerne ljestvice plivačke kompetencije i angažiranosti imaju koeficijente pouzdanosti od dobrih 0,74 za ljestvicu plivačke angažiranosti do visokih 0,90 za ljestvicu opće plivačke kompetencije. Sve su ljestvice homogene jer u svakoj ljestvici čestice imaju samo jednu latentnu osnovu. Faktorom objašnjena varijanca među konstruiranim ljestvicama varira od 51 % do 67 %. Distribucije svih ljestvica ne razlikuju se značajno od normalne distribucije. To pokazuje kako su ljestvice metrijski osjetljive i kako su središnje vrijednosti (aritmetička sredina i standardna devijacija) kvalitetni reprezentanti rezultata testa. Kvalitetne mjerne značajke ljestvica omogućavaju primjenu parametrijskih statističkih postupaka u daljnjem tijeku istraživanja. Rezultati mjerenja na testu *plivanje 50m slobodno* variraju u rasponu od minimalnih 30,72s do 69,03s, a prosječan rezultat na testu iznosi 43,56 sekundi. Distribucija rezultata testa plivanja pokazuje kako je velik broj rezultata grupiran oko i ispod aritmetičke sredine, dok je samo manji broj rezultata pozicioniran iznad rezultata od 50 sekundi.

Tablica 2. Faktorska valjanost ljestvica plivačke kompetencije

VAR	FAKTOR
	1
PLV_KOMP	-0.86
SPAS_KOMP	-0.72
PLIV_STIL	-0.87
EIGEN	2.01
% VAR	67 %

LEGENDA: FAKTOR – faktorske saturacije čestica; EIGEN – ukupna objašnjena varijanca; % VAR – postotak varijance objašnjen faktorom.

Rezultati faktorske analize pokazuju kako tri različita testa za ispitivanje *plivačke kompetencije* imaju zadovoljavajuću faktorsku valjanost jer imaju zajedničku latentnu osnovu.

Provedenom korelacijskom analizom su utvrđene značajne negativne korelacije rezultata *plivanja na 50m* s ljestvicama *plivačke kompetencije* i *angažiranosti*, izuzev s ljestvicom *kompetencije spašavanja*. Korelacije su negativne jer bolji plivački rezultati imaju nižu apsolutnu brojčanu vrijednost. Također, plivačka angažiranost je značajno povezana s rezultatima ljestvica kompetencija izuzev ljestvice *kompetencije spašavanja*. Ove interkorelacije ljestvica plivačke angažiranosti i plivačke kompetencije, uključujući njihove korelacije s varijablom plivačke uspješnosti, predstavljaju kvalitetnu osnovu za provedbu multiple regresijske analize. Regresijskom analizom utvrdio se specifičan doprinos svake pojedine varijable u objašnjavanju rezultata plivačke uspješnosti mornara.

Tablica 3. Utjecaj prediktorskog skupa varijabli na uspješnost plivanja 50 m slobodno

VARIJABLA	PLIVANJE 50m	
	BETA	P
PLV_KOMP	-0.04	0.82
SPAS_KOMP	0.04	0.79
PLV_STIL	-0.50**	0.005
PLIV_ANG	-0.15	0.35
R	0.60***	
R ²	0.37	
P	0.001	

Legenda: R- koeficijent multiple korelacije; R²- koeficijent determinacije; BETA - regresijski koeficijent; P - razina značajnosti koeficijenta.

Prediktorski skup varijabli sastavljen od procjena plivačkih kompetencija i angažiranosti ima značajan utjecaj na plivačku uspješnost mornara. Koeficijent regresijske determinacije između mjera plivačke kompetencije i angažiranosti i plivačke uspješnosti mornara iznosi $R^2 = 0,37$, što pokazuje kako je 37 % varijance varijable plivačke uspješnosti objašnjeno prediktorskim skupom varijabli. Utvrđuje se i pojedinačni značajan utjecaj varijable *poznavanje plivačkog stila* (PLIV_STIL) na rezultate plivanja 50m slobodnim stilom mornara.

RASPRAVA I ZAKLJUČAK

Od tri ljestvice *plivačke kompetencije* najvišu aritmetičku sredinu ima kompetencija *spašavanja*, nešto nižu ljestvica *plivačke kompetencije*, a najnižu ljestvica *poznavanja plivačkog stila*. To pokazuje kako su mornari spremniji poduzeti akciju spašavanja utopljenika i «iznad» svojih plivačkih kompetencija i poznavanja stilova. Motivacija za spašavanjem trebala bi se prvenstveno temeljiti na visokoj plivačkoj kompetentnosti «spasioca» inače se postupkom spašavanja ugrožava i život samog spasioca. Niti jedan ispitanik nema najviši mogući rezultat na ljestvici poznavanja plivačkog stila, a prosječan rezultat na ljestvici *plivačke angažiranosti* pokazuje nisku razinu plivačke angažiranosti mornara. Prosječan rezultat mornara na testu *plivanja 50m slobodno* je zadovoljavajući, ali distribucija rezultata pokazuje kako manji skupina mornara imaju rezultate više od 50 sekundi. Kako bi se poboljšale i plivačke kompetencije i poznavanje plivačkih stilova preporuča se značajno povisiti plivačku angažiranost mornara, ali uz kvalitetno i stručno vođenje za poboljšavanje plivačkih tehnika, posebice za ovu manju skupinu «lošijih» plivača. Rezultati provedene faktorske analize na ukupnim rezultatima ljestvica *plivačke kompetencije* utvrđuje postojanje generalnog, općeg faktora plivačke kompetencije pri čemu ove ljestvice utvrđuju kao njeni *faceti*, područja opće kompetencije. *Opća plivačka kompetencija* sastoji se tako od procjene kompetencija za: plivanje po mirnom, nemirnom i valovitom moru; plivanje sa i bez odjeće; dugotrajno i daljinsko plivanje; procjenu kompetencija spašavanja utopljenika; te poznavanje različitih plivačkih stilova i plivačkog okreta. Uspoređujući konstruirane ljestvice s ljestvicama percipiranih sportskih kompetencija i kineziološke angažiranosti autora Milavić, Guć i Maleš (2008) i Milavić, Guć i Miletić (2010), zamjetno je kako je ljestvica plivačke angažiranosti osjetljiva za razliku od ljestvice kineziološke angažiranosti, dok su sve ljestvice percipirane kompetencije (opće, specifične, a i plivačke) osjetljive. Pragmatična valjanost konstruiranih ljestvica je potvrđena kvalitetnom predikcijom

plivačke uspješnosti mornara. Pokazalo se kako je od tri mjere plivačke kompetencije mjera *poznavanje plivačkog stila* (PLIV_STIL) «najuspješnije» u predikciji plivačke uspješnosti. S obzirom da kvaliteta poznavanja plivačkog stila uvjetuje i kvalitetu iskoristivosti plivačkih mogućnosti svakog pojedinca pri plivanju, ovaj je nalaz i očekivan. Međutim, ne treba odbaciti niti doprinos drugih ljestvica plivačke kompetencije ili ljestvice plivačke angažiranosti koje se u budućim istraživanjima mogu pokazati kao kvalitetni i značajni prediktori za neke druge plivačke ili pak spasiteljske zadatke. Iz ovog istraživanja moguće je za stručnjake kineziološke, ali i drugih struka izvesti nekoliko značajnih preporuka: moguće je na temelju upitnika plivačke kompetencije i plivačke angažiranosti napraviti „grubu“ kategorizaciju očekivane plivačke uspješnosti mornara u slučaju kada nije moguće provesti plivačko testiranje; u cilj poboljšanja plivačke uspješnosti mornara preporuča se uvijekbavanje osnova plivačkih stilova mornara, posebice plivanja slobodnim (kraul) stilom koji se pokazao kao najznačajniji u ljestvici *poznavanja plivačkog stila*; potrebno je provoditi redovito plivačko kondicioniranje za mornare članove posada brodova kako bi poboljšali plivačku uspješnost potrebnu za svoje moguće spašavanje plivanjem; mornari su spremni provoditi plivačko spašavanje i iznad svojih plivačkih kompetencija i mogućnosti, te je potrebno provesti kategorizaciju plivanja mornara i dati im točnu povratnu informaciju o tome jesu li oni osobno sposobni ili ne provesti neki oblik plivačkog spašavanja druge osobe; provesti specijalizaciju dijela mornara za postupak i provedbu plivačkog spašavanja.

Opravdano je zaključiti kako su konstruirane tri višestruke ljestvice *plivačkih kompetencija* i ljestvica *plivačke angažiranosti*, dobrih mjernih karakteristika, a pragmatična valjanost skupa varijabli sastavljenih od novokonstruiranih ljestvica je dobra jer skup ostvaruje značajnu predikciju plivačke uspješnosti mornara. Konstrukcija ovih ljestvica i njihova primjena omogućuje „grubu“ kategorizaciju plivačke uspješnosti mornara, a koju je opravdano provoditi samo u slučaju nemogućnosti provedbe pravog testiranja plivačke uspješnosti. Preporuča se nastaviti daljnja istraživanja relacija konstruiranih mjera plivačke kompetencije i plivačke angažiranosti s različitim oblicima plivačke uspješnosti (plivanje u odjeći, plivanje s puškom, spašavanje utopljenika, daljinsko plivanje, ronjenje, izvođenje podvodnih i/ili površinskih zadataka i drugi).

LITERATURA

Cox, R. H. (2005). *Psihologija sporta – koncepti i primjene*. Jastrebarsko: Naklada Slap.

Guć, D., Vuković, A., & Maleš, B. (2007). Relacije između nekih funkcionalnih motoričkih sposobnosti i plivanja vojnika/mornara HRM. *Proceedings of the 2nd International Conference «Contemporary Kinesiology»* (pp. 139-142). Mostar: Faculty of Kinesiology – Split; Faculty of NSM&E – Mostar.

Findak V. (1999). *Metodika tjelesne i zdravstvene kulture – priručnik za nastavnike TZK*. Zagreb: Školska knjiga.

International Life Saving Federation. (2007). *World Drowning Report – 2007 Edition*. Leuven, Belgium. Mrežnoj stranici <http://www.ilsf.org/drowning-prevention/report> pristupljeno 15. svibnja 2015.

International Life Saving Federation (2011). *Drowning facts*. Mrežnoj stranici <http://www.ilsf.org/en/drowning/facts> pristupljeno 03. rujna 2011.

Milavić, B., Guć, D., & Maleš, B. (2008). Utjecaj vojnog treninga na stav o sportu i zaokupljenost sportom. *Proceedings of the 3rd International Conference «Contemporary Kinesiology»* (pp. 168-173). Mostar: Faculty of Kinesiology – Split; Faculty of NSM&E – Mostar; Faculty of Sport – Ljubljana.

Milavić, B., Guć, D., & Miletić, Đ. (2010). The Relations Between Types Of Motivation in Sport And Perceived Sport Competence. *FACTA UNIVERSITATIS, Series Physical Education and Sport*, 8(1), 59-69.

Zahorjević A. (1982). *Plivanje – od obuke do suvremene tehnike*. Beograd: Partizan.

World Health Organization (2014). *Global report on drowning: preventing a leading killer*. Mrežnoj stranici http://www.who.int/violence_injury_prevention/global_report_drowning/en/ pristupljeno 15. svibnja 2015.

Effects of off-season sand training on physical performance in adolescent indoor volleyball players

Goran Sporiš¹, Nebojša Trajković², Damir Jurko³

¹Faculty of Kinesiology, Zagreb, Croatia

²Faculty of Sport and Physical Education, Niš, Serbia

³Faculty of Humanities and Social Sciences, University of Split, Croatia

ABSTRACT

The aim of the present study was to assess the effects of sand off-season training program on physical performance in adolescent indoor volleyball players. Nineteen adolescent male volleyball athletes (16±2 years) consented to participate in program and lower-body power and agility testing. The participants performed the SJ, CMJ, Attack, Block jump tests and Standing Broad jump test for lower-body power and Sprint 9-3-6-3-9 m and T Test for agility. One cycle of eight weeks was analyzed in off-season (2014). Players were involved in specialized program on sand and exercise were selected based on previous experience and according to performance analysis in volleyball studies. There were no significant differences ($p > 0.05$) between pretraining and posttraining for Block jump ($p=0.612$) and Spike jump ($p=0.525$). However, there was a significant ($p \leq 0.05$) improvement in SJ, CMJ and standing broad jump. Results for agility tests showed there were no significant differences between groups pre- to post-training ($p > 0.05$). The results of this study indicate that there were significant improvements in jumping performance. However, there was no significant improvement in the 9-3-6-3-9 agility test and T test. According to our results and previous research, clear conclusion about the effects of training in sand could not be given. However, this kind of study could provide practical application for coaches and sport researchers.

Key words: volleyball, impact, sand, jumping ability, running

INTRODUCTION

Off-season strength and conditioning programs for athletes are instrumental in helping to prepare for the sport season. The strength and

conditioning professional’s primary responsibility is to design and implement the off-season program. Common program goals are to reduce injury and improve performance (Jones et al, 2010). Men’s volleyball at younger level can be divided into 2 seasons: fall and spring (Table 1). Between fall and spring season is one a period called off season where athletes can rest, be involved in organized program or do some individual practices. Most professional athletes have the advantage of getting professional trainers to plan their off-season program for them. It is common for off-season conditioning programs in adolescent semi-professional players to be supplied without appropriate explanation or supervision.

Table 1. Periodization scheme for indoor volleyball in Serbia

Jun	Jul	Aug	Sep	Oct	Nov	Dec	Jan	Feb	Mar	Apr	May
Off-sea- son		Pre-sea- son		In-sea- son			Transi- tion	In-sea- son			

Periodization schemes for in-season training will necessarily differ from those applied during off-season and preseason training cycles. (Gamble, 2013). According to Bangsbo (1994), offseason training should have an equal focus on high-intensity aerobic training, anaerobic speed and speed endurance. Goals of the off season include providing a base level of conditioning, preparing the body for more intense training, and combating muscle imbalances to reduce the risk of injuries (Baechle and Earle, 2000). Accordingly, players who had failed to complete a certain number of off-season training sessions suffered a higher incidence of adductor muscle injuries when they reported to preseason training camp (Emery and Meeuwisse, 2001). Smart and Gill (2013) found greater improvements in strength, anaerobic leg power (VJ and 10-m sprint time) and body composition in adolescent rugby union players who were supervised over a 15-week off-season physical conditioning program compared with a similar group that completed the same program but were not supervised. Important consideration regarding the influence of training on muscle performance is the nature of the training surface. Sand surface is associated with a greater degree of shock absorbance and lower stress to soft tissue and bones on the lower limbs (Barrett, et al, 1997). In addition, less muscle soreness is observed after similar plyometric activity on a sand surface compared to a firm, wooden surface (Miyama & Nosaka, 2004). Moreover, Impellizzeri et al. (2008) reported similar improvements in jumping and sprinting ability following four weeks of plyometric training

INVITED LECTURES
POZVANA PREDAVANJA

on sand and grass surfaces. Mirzaei, et al. (2014) also examine the effects of six weeks of depth jump vs. countermovement jump training on sand on muscle soreness, jump, sprint, agility and leg press strength and found that training on sand can improve jumping and sprinting ability, agility and strength performance.

Common characteristic of conditioning programs in semi professional and amateur athletes is a relatively long active rest period between the conclusion of the season and the onset of the off-season training program. Few data are available including training programs after this longer period of activity in a previously trained group of athletes. Within this context, the purpose of this study was to examine the effects of sand off season training program on physical performance in indoor adolescent volleyball players.

METHODS

Subjects

Twenty-two adolescent volleyball players consented to participate in lower-body power and agility testing, and the procedures involved in the study were in accordance with and approved by institutional ethics. As a result of dropout because of varied reasons (e.g., injury, illness, relocation), a total of 19 players completed the study. Descriptive characteristics are presented in Table 1. All the participants provided written consent after being informed of the test protocol. The protocol of the study was approved by the Ethical Committee of the Faculty of sport and physical education, University of Nis, and according to the revised Declaration of Helsinki. Each player had at least 4 years of training experience, corresponding to 2-hour training sessions, and at least 1 competition per week.

Table 1. Descriptive characteristics of the subjects*

Age (y)	Training experience (y)	Body height (cm)	Body weight (kg)	Standing reach height (cm)
16±2		1.84 ± 0.08		232±8.48
5±1		71±3		

*Data are reported as mean ± SD.

Procedures

This study was designed to address the question of how training on sand affect jumping ability and agility gains, after a 8-week training program. Jumping ability, and agility performance tests were performed before and after training. This design enabled us to examine the impact of sand surface on muscular performance. The initial tests were completed on one day as part of a regular testing program. Before the initiation of the training program subjects were instructed about the proper execution of all the exercises that were to be done during the training period. None of the subjects had performed any strength or jump training before. They were instructed to avoid any strenuous physical activity during the experiment and to maintain their dietary habits for the whole duration of the study. The players underwent physical tests assessment in an indoor stadium. During the testing, the air temperature ranged from 22°C to 25°C. Testing began at 10 am and finished by 1 pm. None of the participants had been injured 6 months before the initial testing as well as during the training program. There was no supplement addition to the diet of the players. Measurements were taken on Monday morning because the athletes had rested during the weekend. The testing session began with anthropometric measurements. The players were then instructed to assess lower-body muscular power and agility tests. Up to 3 trials were given on each jump, with a 1-minute rest between jump test trials. The participants were all tested during the off- season. Typical practice warm-up was completed before the testing sessions. This warm-up included 10 minutes of general activity (walk, jog, light stretching), followed by 10 minutes of dynamic activity that increased in speed and intensity, followed by 3 to 5 minutes of rest before beginning the testing session. The players were encouraged to perform static stretching between trials. Body height and body weight were measured according to the instructions of the International Biological Program – IBP. Body height was measured with a GPM anthropometer (Siber & Hegner, Zurich, Switzerland) to the nearest 0.1 cm. Body weight was obtained by TANITA BC 540 (TANITA Corp., Arlington Heights, IL) to the nearest 0.1 kg.

Measures

Countermovement and Squat Jump Performance

For the purpose of the explosive strength assessing, a device “Myotest” was used. Subjects performed two vertical jumps, Countermovement Jump (CMJ) and Squat jump (SJ). The sample of the variables, processed and mistreated

by the device "Myotest" consisted of the: Height (expressed in cm); Power (expressed in W/kg); Force (expressed in N/kg) and Velocity (expressed in cm/s). Subjects carried a belt around their lower trunk, on which was positioned a wireless device "Myotest" (safely attached to a belt). All subjects performed three vertical jumps (CMJ), in the following way: from the initial position, i.e., normal standing position and the hands placed on the hips, through the flexion in the articulations of the knee up to 90°, after the audio signal of the device, the subjects performed the maximum vertical take-off, and landed with affable flexion (up to 110°) in the articulations of the knee and finally, went back into a starting standing position, while waiting for the new sound signal, when the specified jump technique was repeated. In the case, when the CMJ was not well performed, double audio signal, informed the subject, to repeat properly specified jumping technique. At the end of the protocol, software of the device "Myotest", automatically processed and mistreated the mean values of analyzed variables.

The squat jump (SJ) allows measurement of "non-pliedometric" displacement and the ability to develop a great deal of strength within a very short space of time (explosiveness). This test consisted of the person jumping as high as possible with their hands on their hips from a half-squat position (i.e. 90° bending of the knees). This position was maintained for about 1s. The subjects were then instructed to extend the lower limbs as explosively as possible with the aim of performing a squat jump. Three attempts were made at this exercise. The best result was retained for analysis.

Spike and block jump performances

For the standing reach, while wearing their normal volleyball footwear, players were requested to stand with their feet flat on the ground, extend their arm and hand, and mark the standing reach height while standing 90° to a wall. Players were encouraged to fully extend their dominant arm to displace the highest vane possible to determine their maximum standing reach height. The measurement of the standing reach height allowed for a calculation of the relative jump heights on each of the jumping tasks (absolute jump height (cm) – standing reach height (cm) = relative jump height) (Sheppard et al, 2009).

Spike (SJ) and block (BLJ) jump performances for volleyball players depend heavily on the height at which these skills are performed above the net and are determined by not only the capacity of the athlete to raise vertically his center of gravity, but also his stature and standing reach. In this particular case,

specific tests would provide a further understanding of the training-induced adaptation. For the SJ, the standing reach was determined as the maximal distance between the fingertip of the attack hand and the ground, while standing 90° to a wall. The SJ was measured from a running lead (2- or 3-step approach) by using a basketball backboard marked with lines 1 cm apart with a 1-minute rest interval between them (Hasegawa, et al, 2002). For the BLJ, the standing reach was determined as the maximal distance between fingertips of the block hands and the ground, while facing the wall. The BLJ jumps started from a standing position with the hands at shoulder level and arms raised from the start position without extra swing. All tests used the same observer who was situated on a volleyball referee stand placed 2 m from the backboard. Both jumps were recorded as the best of the 3 attempts.

The standing broad jump was used for assessing the explosive power of the lower limbs. The players were instructed to stand behind a line and jump as far as possible—allowing arm and leg countermovement. The distance was measured from behind the line to the back of the heels at landing. The intraclass correlation coefficient for test-retest reliability and for the SBJ test was 0.97, respectively.

Agility tests

T-test

Four cones are placed on the support as follows: first cone marks the start; second cone is placed 10 m ahead of the first one; third cone is placed 5 m right from the second cone, and fourth cone 5 m left from the second cone. On the examiner's signal, the subject runs forward from the first to the second cone, then side steps right to the third cone, then side steps left to the fourth cone, then side steps right to the second cone and run backwards to the first cone, thereby touching each cone with his/her hand. The test is discontinued when the subject touches the first cone;

Sprint 9-3-6-3-9 m with 180° Turns (S180°)

The players started after the signal and ran 9 m from starting line A to line B (the lines were white, 3 m long, and 5 cm wide). Having touched line with one foot, they made either an 180° left or right turn. All the following turns had to be made in the same direction. The players then ran 3 m to other line, made another 180° turn, and ran 6 m forward. Then, they made another 180° turn and ran another 3 m forward, before making the final turn and running the final 9 m to the finish line.

Training program

Table 2. Training sessions of sand based training program

Goal: Off-season sand training program	
Sessions 1–24 (Monday-Wednesday-Friday)	
Exercises	
Warm up	General activity + specific warm up (25 min)
Conditioning drills	Cone agility drills in the sand, short speed drills, Jump Squats, Split jump variations, Broad jumps, hurdle hops (30 min)
3 vs. 3, 2 vs. 2	Competition beach volleyball drills with the majority of free balls to each side thrown by the coach. Teams rotate depending of the scoring. After one team reaches 15 points players take two minute break (30 min).
Stretching	5 minutes of stretching for the muscle groups mainly involved in sessions

One cycle of eight weeks was analyzed in off-season (2014). The schedule of the performed off-season sand training is shown in Table 2. The goals of the off-season conditioning were to increase the intensity of sport-specific training, and attention was given to specific volleyball conditioning and movement in sand. Training program was realized on two beach volleyball courts. One week before the training program players performed the general conditioning in order to level the conditioning of players after the break. None of the players was performing any additional resistance or aerobic training outside of the sand training sessions. The duration of training sessions was recorded, with sessions typically lasting 90 min.

Table 3. Principles of conditioning drills on sand

Training categories	Exercise time	Recovery time	Intensity	Number of repetitions and sets
Speed drills	2-5 sec	>10 x exercise time	80-100%	6-24 reps/3-6 sets
Agility drills	5-10 sec	>5 x exercise time	70-90%	5-15 reps/2-4 sets
Jumping drills	10-20 sec	>3 x exercise time	70-90%	8-15 reps/2-4 sets

Statistical Analyses

Data analysis was performed using the Statistical Package for Social Sciences (v13.0, SPSS Inc., Chicago, IL, USA). Descriptive statistics were

INVITED LECTURES
POZVANA PREDAVANJA

calculated for all the experimental data. In addition, the Kolmogorov–Smirnov test of the normality of distribution was calculated for all variables before the analysis. Changes in the lower-body muscular power and agility of players over the training period were compared using t-tests. The level of significance was set at $p \leq 0.05$ and all data are reported as means \pm SE.

RESULTS

Lower-body muscular power

Changes in Block jump, Spike jump and Standing broad jump are shown in Table 4. There were no significant differences ($p > 0.05$) between pretraining and posttraining for Block jump ($p=0.612$) and Spike jump ($p=0.525$). However, there was a significant ($p \leq 0.05$) improvement in Standing broad jump. In SJ and CMJ statistically significant difference was found pre- to post-training ($p < 0.05$) after 8 weeks of sand training.

Table 4. Lower-body muscular power and agility of young volleyball players before and after 8 weeks of sand training

	initial	final	P value
Block jump	48.36 \pm 3,795	48,64 \pm 4,031	0.612
Spike jump	58.29 \pm 4.890	58.57 \pm 5.019	0.525
Standing broad jump	211.93 \pm 1.93	215.21 \pm 0.83	0.009*
SJ	30.29 \pm 4.65	33.21 \pm 3.91	0.002*
CMJ	36.16 \pm 6.59	40.87 \pm 5.62	0.000*
9-3-6-3-9 agility test	7.95 \pm 0.49	7.58 \pm 0.52	0.996
T-test	9.01 \pm 0.30	9.08 \pm 0.27	0.522

* Significant difference $p < 0.05$ between initial and final testing

There were no significant differences ($p > 0.05$) between pre-training and post-training for agility tests. (Table 4).

DISCUSSION

This study investigated the effect of sand training program on the measurements of physical fitness in adolescent male indoor volleyball players. A significant improvement was observed for SJ, CMJ and Standing broad jump. However, there were no significant differences between pretraining and posttraining for specific volleyball jumps, Spike and Block jump.

In our study, results for Block jump and Spike jump test showed there were no significant difference between groups pre- to post-training ($p >$

0.05). This findings are in contrast with those of Gehri et al. (1998) and Thomas et al. (2009) who reported significant improvement in jump height after 12 and six weeks of Drop jump and Counter movement jump training on solid surface with no differences between them. According to previous authors suggestions the longer contact time can induce the less effective the Stretch shortening cycle (Saez-Saez De Villarreal, et al, 2009). During performing plyometrics on sand, compliance and friction can plays negative effects on SSC, decreases of myotatic reflex, degraation of elastic energy potentiating and increase amortization phase resulting worsens in performance (Impellizzeri, et al, 2008; Giatsis, et al, 2004). The role of the Stretch shortening cycle in jump performance appears to be lower for beach volleyball than other team sports, however it is still an important component of performance. The importance of players having a high power to weight ratio is evident and should be carefully considered when designing and monitoring volleyball athlete training programs (Riggs & Sheppard, 2009). Several authors have reported significant improvements in Vertical jump, countermovement jump and Standing broad jump using jumping training in sand (Chu, 1998; Asadi, 2012; Markovic, et al, 2007), which is in line with our results. However, there is still a discrepancy about the factors influencing these improvements.

Results for agility tests showed there were no significant differences between groups pre- to post-training ($p > 0.05$). These findings are in contrast with the previous authors who reported significant decreases in time during agility tests following training (Thomas et al. 2009; Mirzaei, B. et al., 2014; Gortsila, et al ,2013). Thomas et al. (2009) compared the effects of six weeks of Drop jump and Countermovement jump training on agility (505 agility test) in young soccer players and found that plyometric training could positively affect agility performance, with no significant differences between the modes. Agility improvement requires rapid force development and high power output, and it seems that Drop jump and Countermovement jump training on sand can improve responses to these requirements (Thomas, et al., 2009). Moreover, agility tasks require a rapid switch from eccentric to concentric muscle action in the leg extensor muscles (the SSC muscle function). Gortsila, et al (2013) showed in their study that training on sand surface could be a useful and effective tool for improving agility in prepubescent female volleyball players. The instability of the sand surface should contributed to the improvements of balance, which in turn should improve agility. This was not the case in our study. The assessments of agility performance have typically utilized change-

of-direction speed tests, that encompass preplanned, closed skill movements (Sheppard, and Young, 2006), which is the case with our test. Although the preplanned movements are important to team sport performance, a limitation of change-of-direction speed tests is that they fail to assess the perceptual component of agility (Gabbett, et al, 2008). Because agility is highly specific there is a need for tests that would include perceptual factors. The perceptual-motor literature strongly suggests that unless the stimulus is sport-specific, skilled athletes are unable to use their perceptual skill to advantage (Young W and Farrow D. A Review of Agility: Practical Applications for Strength and Conditioning, *Strength and Conditioning Journal*, Volume 28, Number 5, pages 24–29, 2006). Therefore, this could be the reason why there was no improvement noticed in agility. In addition, because of the apparent contribution of many physical characteristics to T-test performance, the test cannot be considered an indicator of any one characteristic alone.

CONCLUSION

The results of this study indicate that there were significant improvements in jumping performance. However, specific volleyball jump tests did not showed improvement in post testing compared to pre testing following 8 week of sand training program. In addition, there was no significant improvement in the 9-3-6-3-9 agility test and T test. It cannot be concluded that adolescent volleyball players develop distinctive performance characteristics at this age and level. Therefore, more studies must be conducted in order to better understand the training on sand and it's effects in indoor volleyball players. According to previous research and our results, clear conclusion about the effects of training in sand could not be given. The differences in intensity of training, training volume and sample size could be a reason of the discrepancy in results. However, this kind of study could provide practical application for coaches and sport researchers. Maintaining supervision during the competition phase may enable an enhanced state for subsequent off-season physical conditioning programs and greater long-term athletic development.

REFERENCES

- Asadi, A. (2012). Effects of six weeks depth jump and countermovement jump training on agility performance. *Journal of Sport Science*, 5, 67–70.
- Baechle, T. R., & Earle, R.W. (Eds.). (2000). *Essentials of Strength Training and Conditioning*. Champaign, IL: Human Kinetics.

Bangsbo, J. (1994). Fitness Training in Football – a Scientific Approach. DBU. Copenhagen: August Krogh Institute, University of Copenhagen, Denmark

Barrett, R.S., Neal, R.J., & Roberts, L.J. (1997). The dynamic loading response of surfaces encountered in beach running. *Journal of Science and Medicine in Sport*, 1, 1-11.

Chu DA. Jumping Into Plyometrics. Champaign, IL: Human Kinetics; 1998.

Fleck, S.J. and Kraemer, W.J. (2004). *Designing resistance training programs* (3rd edn), Human Kinetics, Champaign, Illinois.

Gabbett, T.J., Sheppard, J.M., Pritchard-Peschek, K.R., Leveritt, M.D., and Aldred, M.J. (2008). Influence of closed skill and open skill warm-ups on the performance of speed, change of direction speed, vertical jump, and reactive agility in team sports athletes. *Journal of Strength and Conditioning Research*, 22(5): 1413–1415.

Gamble, P. (2013). *Strength and conditioning for team sports: sport-specific physical preparation for high performance*. 2nd ed. New York: Routledge.

Garhammer, J. (1979). Periodization of strength training for athletes. *Track Tech*. 73:2398-2399.

Gehri, D.J., Ricard, M.D., Kleiner, D.M., & Kirkendall, D.T. (1998). A Comparison of Plyometric Training Techniques for Improving Vertical Jump Ability and Energy Production. *Journal of Strength and Conditioning Research*. 12(2), 85-89.

Giatsis, G., Kollias, I., Panoutsakopoulos, V. and Papaiakevou, G. (2004). Biomechanical differences in elite beach-volleyball players in vertical squat jump on rigid and sand surfaces. *Sports Biomechanics*. 3(1):145-158

Gortsila, E., Theos, A., Nestic, G., Maridaki, M. (2013). Effect of Training Surface on Agility and Passing Skills of Prepubescent Female Volleyball Players, *Journal of Sports Medicine and Doping Studies*, 3(2), 1-5.

Hasegawa H, Dziados J, Newton RU, Fry AC, Kraemer WJ, Hakkinen K. Periodized training programmes for athletes. Oxford: Blackwell Science; 2002. pp. 69–134. *Handbook of Sports Medicine and Science: Strength training for sports*.

Hickson, R. C., Kanakis, Jr, C, Davis, J. R, Moore, A. M and Rich, S (1982), Reduced training duration effects on aerobic power, endurance and cardiac growth, *Journal of Applied Physiology*, 53, pp. 225–29.

Impellizzeri, F.M., Rampinini, E., Castagna, C., Martino, F., Fiorini, S., Wisloff, U. (2008). Effect of plyometric training on sand versus grass on muscle soreness and jumping and sprinting ability in soccer players. *British Journal of Sports Medicine*, 42(1), 42–46.

Jones, M.T., Matthews, T.D., Murray, M., Van Raalte, J., and Jensen, B. E. (2010). Psychological correlates of performance in female athletes during a 12-week off-season strength and conditioning program. *Journal of Strength and Conditioning Research*, 24(3), 619–628.

Markovic, G., Jukic, I., Milanovic, D., Metikos, D. (2007). Effects of sprint and plyometric training on muscle function and athletic performance. *Journal of Strength and Conditioning Research*, 21(2):543–549.

Mirzaei, B., Norasteh, A. Saez de Villarreal, E., and Asadi, A. (2014). Effects of six weeks of Depth jump vs. Countermovement jump training on sand on muscle soreness and performance, *Kinesiology*, 461:97-108.

Miyama, M., & Nosaka, K. (2004). Influence of surface on muscle damage and soreness induced by consecutive drop jumps. *Journal of Strength and Conditioning Research*, 18, 206-211.

Neufer, P. D., Costill, D.L., Fielding, R.A., Flynn, M.G. and Kirwan, F.P. (1987). Effect of reduced training on muscular strength and endurance in competitive swimmers, *Medicine and Science in Sports and Exercise*, 19, 486–90.

Riggs, M. P., Sheppard, J. M. (2009) The relative importance of strength and power qualities to vertical jump height of elite beach volleyball players. *Journal of Human Sport & Exercise*, 4 (3), 221-236.

Saez-Saez De Villarreal, E., Kellis, E., Kraemer, W.J., Izquierdo, M. (2009). Determining variables of plyometric training for improving vertical jump height performance: a meta-analysis. *Journal of Strength and Conditioning Research*, 23(2):495–506.

Sheppard, J.M. and Young, W.B. (2006). Agility literature review: classifications, training and testing. *Journal of Sports Science*, 24, 919–932.

Smart, D. J., and Gill, N. D. (2013). Effects of an off-season conditioning program on the physical characteristics of adolescent rugby union players. *Journal of Strength and Conditioning Research*, 27(3), 708–717.

Stone, M.H., O'Bryant, H.S., Gahammer J., McMillan, J., Rozenek, R. (1982). A theoretical model of strength training. *NSCA J.* 4(4):36-40.

Thomas K., French D., Hayes P.R. (2009) The effect of two plyometric training techniques on muscular power and agility in youth soccer players, *Journal of Strength and Conditioning Research*, 23(1), 332-335.

Young, W. and Farrow, D. (2006). A Review of Agility: Practical Applications for Strength and Conditioning, *Strength and Conditioning Journal*, 28 (5), 24-29,

Utjecaj veličine populacije na rezultatsku uspješnost država na svjetskim taekwon-do prvenstvima ITF načinom

Andreja Ivas¹, Dražen Čular¹, Stipe Blažević²

¹Faculty of Kinesiology, University of Split, Croatia

²Faculty of Economics, University of Rijeka, Croatia

ABSTRACT

The aim of this research is to define the influence of the population size on the success in results of countries at ITF taekwon-do world championships. The sample consists of 69 countries from all 6 continents whose national teams have won medals at ITF world championships in the period from 1987 to 2014. The data was gathered from 34 junior, senior and veteran championships all together and in the purpose of conducting this research 74 variables which include the number of gold, silver and bronze medals won at world championships have been analysed. Reviewing the results of previous research of result success of countries at big competitions in this analysis the variable of population size (number of citizens) of each country has been included as the predictor variable. The success of each country was gained by the official scoring gold=7, silver=3 and bronze=1 point. Using the correlative analysis it was determined that at the level of relevance $p < 0.05$ there is (0.21) a certain statistically relevant connection between the success variable of countries at world championships and the population size of each country. There has also been defined the order (rank) of country success in general according to the total of points from world championships from 1987 to 2014. Based on the calculation of the coefficient of relative country success (TOTPOINT/POPUL) in relation to population size (number of points per one million citizens) the relative order (rank) of country success has been determined, too.

Key words: *result, world championship, taekwon-do, success, population, correlation*

UVOD

Doslovnim prijevodom „TAE“ predstavlja udarac nogom, „KWON“ označava udarac šakom i „DO“ znači put. Uzeto u cjelini „TAE KWON-DO“ označava umijeće borbe rukama i nogama na putu postizanja mentalne i tjelesne forme u svrhu samoobrane i zdravlja.

Prema Markoviću i sur. (2005), Čularu i sur. (2013) razlikujemo dva sustava (*stila*) natjecanja u taekwondou (*WTF-olimpijski i ITF-neolimpijski*). Navedeni sustavi se razlikuju po natjecateljskim pravilima i zaštitnoj opremi, a samim time i tehničko-taktičkom pristupu te čimbenicima koji utječu na rezultatski uspjeh.

U ITF sustavu natjecanja se provode u pet disciplina (*sportskoj borbi, tehničkoj disciplini izvođenja formi, specijalnim tehnikama, testu snage i samoobrani*) te u četiri dobne skupine (*kadeti, juniori, seniori, veterani*). U disciplini forme tzv. borbi sa zamišljenim protivnikom dva natjecatelja izvode dvije forme jednu ovisno o stupnju zvanja te drugu po izboru sudaca. Ukupno 24 forme dijelimo na učeničke (od žutog do crnog pojasa) i majstorske (od 1. do 9. dana)

Odluku o pobjedi donosi pet sudaca prema službenom kriteriju bodovanja. Pored pojedinačnog natjecanja egzistira i timska disciplina u kojoj pet članova simultano izvodi forme uz uvježbanu koreografiju.

Borba se završava predajom, diskvalifikacijom ili prebrojavanjem bodova na kraju meča. Ako je rezultat nakon dvije runde izjednačen natjecateljima se dodjeljuje još jedna runda od dvije min a ako je i nakon te runde rezultat izjednačen borba se nastavlja do prvog postignutog poena.

Obzirom na medijsku popularnost olimpijske WTF verzije, postoji relativno mali broj istraživanja koja su posvećena ITF verziji.

Tako je i ovaj rad prema dostupnim podacima jedan od rijetkih koji se bavi istraživanjem ovog sporta a ujedno i jedini koji se bavi istraživanjem odrednica uspješnosti država u ITF „tradicionalnoj“ verziji taekwon-do-a. Bernard i Busse (2004) bave se predviđanjem raspodjele medalja po državama. Cilj im je bio pronaći varijable koje imaju utjecaj na raspodjelu medalja. Na prikupljenim podacima od 1960. do 1996. izrađen je empirijski model. Daljnja istraživanja proširuju model dodatnim varijablama za koje se isto tako smatralo da utječu na uspješnost pojedine države. Johnson i Ali (2000) prezentirali su dva modela također na temu uspjeh država na Olimpijadama. Istraživanje je provedeno na rezultatima od 1952. do 1996. godine te su uključene varijable: *BDP po stanovniku, prednost domaćina, geografska blizina države domaćina, politički*

sistem i bivše kolonijalne veze. U prvom modelu procjenjuju se sudionici po državama. Nakon brojnih zapažanja donesen je zaključak koji ukazuje na dvostruko povećanje broja sudionika države domaćina dok se broj okolnih država povećao za 25%. Drugi model procjenjuje olimpijski uspjeh država. U radu je dokazano da se prednost domaćina za uspjeh na Olimpijadi dodaje dvanaest posto veće šanse.

Bian (2005) je u svom radu imao za cilj analizu različitih varijabli korištenih za predviđanje medalja koje će država osvojiti. U radu su korišteni osnovni modeli Johnson-a i Ali-a (2000) i Bernard-a i Busse-a (2004) te podaci sa Olimpijskih igara 1988., 1992., 1996., 2000.

Na Olimpijskim igrama u Pekingu 2008., SAD se u poretku našao na drugom mjestu iza Kine po broju osvojenih zlatnih medalja, ali su po ukupnom broju medalja ispred njih. To je stvorilo dosta rasprave o tome koliko je brojenje medalja pravedno te koji bi se sustav rangiranja trebao koristiti. U nastavku su prezentirani modeli koji se mogu koristiti pri vrednovanju rezultatske uspješnosti država na velikim sportskim natjecanjima:

Zbog upitne pravednosti sustava prebrojavanja medalja koju koristi internacionalna taekwon-do federacija, u svrhu ovog istraživanja korišten je wtf-ov službeni model bodovanja (7-3-1).

Osnovni cilj ovog rada je istraživanje utjecaja veličine populacije na rezultatsku uspješnost država na svjetskim prvenstvima u ITF taekwon-do-u. Radi cjelokupnog uvida te što kvalitetnije spoznaje o rezultatskoj uspješnosti država na svjetskim taekwon-do prvenstvima osnovni cilj je podijeljen na parcijalne ciljeve: Utvrđivanje generalne uspješnosti država po broju ukupno osvojenih bodova na dosad održanim svjetskim prvenstvima (1987- 2014); Utvrđivanje relativne uspješnosti država po broju ukupno osvojenih bodova na dosad održanim svjetskim prvenstvima (1987- 2014) obzirom na veličinu populacije (broj stanovnika); Utvrđivanje uspješnosti država po broju ukupno osvojenih bodova na dosad održanim svjetskim prvenstvima (1987- 2014) u tri različite federacije; Utvrđivanje povezanosti broja stanovnika i ukupno osvojenih bodova na dosad održanim svjetskim prvenstvima (1987-2014) u tri različite federacije.

METODE RADA

Ispitivanje je provedeno na uzorku od 69 entiteta (država) čiji su reprezentativci osvajali medalje na svjetskim taekwon-do prvenstvima ITF načinom od 1987. do 2014. godine unutar tri po broju država članica

najrelevantnije federacije. Podaci o broju osvojenih zlatnih, srebrnih i brončanih medalja prikupljeni su sa web adresa taekwon-do klubova i federacija.

U pripremi ovog istraživanja analizirana je ukupno 74 varijabli, podaci su prikupljeni sa ukupno 33 svjetska prvenstva unutar tri federacije te je kao i kod ispitanika jedno prvenstvo izbačeno (1974. Montreal, Kanada) radi veće homogenosti podataka.

Država	Broj zlatnih medalja 1995 (1995 Z)
Broj stanovnika (BR.ST. 2014)	Broj srebrnih medalja 1995 (1995 S)
Broj zlatnih medalja 1987 (1987 Z)	Broj brončanih medalja 1995 (1995 B)
Broj srebrnih medalja 1987 (1987 S)	Broj zlatnih medalja 1996 (1996 Z)
Broj brončanih medalja 1987 (1987 B)	Broj srebrnih medalja 1996 (1996 S)
Broj zlatnih medalja 1988 (1988 Z)	Broj brončanih medalja 1996 (1996 B)
Broj srebrnih medalja 1988 (1988 S)	Broj zlatnih medalja 1997 (1997 Z)
Broj brončanih medalja 1988 (1988 B)	Broj srebrnih medalja 1997 (1997 S)
Broj zlatnih medalja 1992 (1992 Z)	Broj brončanih medalja 1997 (1997 B)
Broj srebrnih medalja 1992 (1992 S)	Broj zlatnih medalja 1998 (1998 Z)
Broj brončanih medalja 1992 (1992 B)	Broj srebrnih medalja 1998 (1998 S)
Broj zlatnih medalja 1993 (1993 Z)	Broj brončanih medalja 1998 (1998 B)
Broj srebrnih medalja 1993 (1993 S)	Broj zlatnih medalja 1999 (1999 Z)
Broj brončanih medalja 1993 (1993 B)	Broj srebrnih medalja 1999 (1999 S)
Broj zlatnih medalja 1994 (1994 Z)	Broj brončanih medalja 1999 (1999 B)
Broj srebrnih medalja 1994 (1994 S)	Broj zlatnih medalja 2000 (2000 Z)
Broj brončanih medalja 1994 (1994 B)	Broj srebrnih medalja 2000 (2000 S)
Broj brončanih medalja 2000 (2000 B)	Broj srebrnih medalja 2007 (2007 S)
Broj zlatnih medalja 2001 (2001 Z)	Broj brončanih medalja 2007 (2007 B)
Broj srebrnih medalja 2001 (2001 S)	Broj zlatnih medalja 2009 (2009 Z)
Broj brončanih medalja 2001 (2001 B)	Broj srebrnih medalja 2009 (2009 S)
Broj zlatnih medalja 2002 (2002 Z)	Broj brončanih medalja 2009 (2009 B)
Broj srebrnih medalja 2002 (2002 S)	Broj zlatnih medalja 2010 (2010 Z)
Broj brončanih medalja 2002 (2002 B)	Broj srebrnih medalja 2010 (2010 S)
Broj zlatnih medalja 2003 (2003 Z)	Broj brončanih medalja 2010 (2010 B)
Broj srebrnih medalja 2003 (2003 S)	Broj zlatnih medalja 2011 (2011 Z)
Broj brončanih medalja 2003 (2003 B)	Broj srebrnih medalja 2011 (2011 S)

Broj zlatnih medalja 2004 (2004 Z)	Broj brončanih medalja 2011 (2011 B)
Broj srebrnih medalja 2004 (2004 S)	Broj zlatnih medalja 2012 (2012 Z)
Broj brončanih medalja 2004 (2004 B)	Broj srebrnih medalja 2012 (2012 S)
Broj zlatnih medalja 2005 (2005 Z)	Broj brončanih medalja 2012 (2012 B)
Broj srebrnih medalja 2005 (2005 S)	Broj zlatnih medalja 2013 (2013 Z)
Broj brončanih medalja 2005 (2005 B)	Broj srebrnih medalja 2013 (2013 S)
Broj zlatnih medalja 2006 (2006 Z)	Broj brončanih medalja 2014 (2014 B)
Broj srebrnih medalja 2006 (2006 S)	Broj zlatnih medalja 2014 (2014 Z)
Broj brončanih medalja 2006 (2006 B)	Broj srebrnih medalja 2014 (2014 S)
Broj zlatnih medalja 2007 (2007 Z)	Broj brončanih medalja 2014 (2014 B)

Na rezultatima varijabli provedena je korelacijska analiza programskim paketom Statistika for windows ver.7.0. „Statistica“ na varijablama. Izvršeno je sređivanje, inspekcija i obrada podataka koja obuhvaća rješavanje sljedećih problema:

Konstrukcija varijabli ukupno osvojenih zlatnih, srebrnih i brončanih medalja te izračun ukupne bodovne uspješnosti: $UKUBOD = (UKUZL * 7) + (UKUSR * 3) + (UKUBR * 1)$.

Utvrđivanje deskriptivnih i distribucijskih parametara za varijable bodovne uspješnosti - analiza mjera varijabilnosti i disperzija rezultata (*aritmetička sredina (as), standardna devijacija (sd), minimalni (min) i maksimalni rezultat (max)*).

Korelacijska analiza korištena je za: Utvrđivanje povezanosti između uspješnosti i veličine populacije tj. broja stanovnika; Utvrđivanje povezanosti između uspješnosti i veličine populacije tj. broja stanovnika unutar tri federacije; Izrada redoslijeda (ranga) rezultatske uspješnosti država: po broju ukupno osvojenih bodova na dosad održanim svjetskim prvenstvima (1987- 2014); po broju ukupno osvojenih bodova na dosad održanim svjetskim prvenstvima (1987- 2014) obzirom na broj stanovnika. (bodovi na milion stanovnika); po broju ukupno osvojenih bodova na dosad održanim svjetskim prvenstvima (1987-2014) unutar tri federacije.

REZULTATI I RASPRAVA

U tablici 1. prikazani su rezultati deskriptivne analize za postavljeni problem istraživanja provedenog na 69 entiteta (država).

Tablica 1. Deskriptivna statistika (n=69)

	AS	MIN	MAX	S.D.	COEF.VAR.	SKE	KUR
BR.STAN	66,81	56,483	1,357,380,000	221,32	331,28	5,34	28,68
UKUBOD	242,26	1,000000	2502,000	450,01	185,76	3,24	11,89
UKUBOD/BR.ST	33,16	0,01	1044,56	127,05	383,18	7,65	61,39

Kazalo: BR.STAN. – ukupan broj stanovnika, UKUPBOD – ukupan broj bodova, UKUBOD/BR.ST. – omjer ukupnog broja bodova na milion stanovnika; AS - aritmetička sredina, Min - minimalni rezultati, Max - maksimalni rezultati, S.D. - standardna devijacija, Coef. Var. – koeficijent varijance Skew.- spljoštenost, Kurt.- raspršenost

U tablici 1. prikazani su rezultati deskriptivne statistike za 69 država koje su osvajale medalje na svjetskim ITF taekwon-do prvenstvima od 1987. do 2014. godine. Rezultati varijable broja stanovnika (BR.STAN.) kao i ukupni bodovi za osvojene medalje (UKUPBOD) ukazuju na širok raspon vrijednosti. Broj stanovnika varira u rasponu od 56.483 do 1.357.380.000, a osvojenih medalja od 1 do 2502. Prosječan broj osvojenih bodova po državi je 33 u rasponu od 0,01 do čak 1044,56 bodova.

U tablici 2. prikazani su rezultati varijable broja stanovnika 69 država koje su sudjelovale i ostvarile rezultate na svjetskim prvenstvima u taekwon-do-u ITF načinom od 1987. do 2014. godine redoslijedom od najveće do najmanje.

Tablica 2. Broj stanovnika po državama

DRŽAVA	BR.STAN. 2014	DRŽAVA	BR.STAN. 2014
Kina	1.357.380.000	Grčka	9.897.247
Indija	1.252.139.596	Švedska	9.592.552
USA	316.128.839	Bjelorusija	9.466.000
Brazil	200.361.925	Austrija	8.473.786
Rusija	143.499.861	Tajikistan	8.207.834
Japan	127.338.621	Honduras	8.097.688
Vijetnam	89.708.900	Švicarska	8.081.482
Njemačka	80.621.788	Bugarska	7.265.115
Francuska	66.028.467	Paragvaj	6.802.295
V. Britanija	64.097.085	El Salvador	6.340.454
Italija	59.831.093	Nikaragua	6.080.478
Engleska	53.012.456	Kirgistan	5.719.500
Južna afrika	52.981.991	Finska	5.439.407

Kolumbia	48.321.405	Singapur	5.399.200
Španjolska	46.647.421	Škotska	5.295.000
Ukraina	45.489.600	Turkmenistan	5.240.072
Argentina	41.446.246	Norveška	5.084.190
Poljska	38.530.725	Irska	4.595.281
Kanada	35.158.304	gruzija	4.476.900
Venecuela	30.405.207	Novi Zeland	4.470.800
Peru	30.375.603	Croatia	4.252.700
Uzbekistan	30.241.100	Puerto Rico	3.615.086
Malezija	29.716.965	Moldavija	3.559.000
Korea	24.895.480	Urugvaj	3.407.062
Taivan	23.374.000	Wales	3.063.456
Australija	23.130.900	Litva	2.956.121
Rumunjska	19.963.581	Mongolija	2.839.073
Čile	17.619.708	Albanija	2.773.620
Kazahstan	17.037.508	Jamajka	2.715.000
Nizozemska	16.804.224	Slovenija	2.060.484
Kambodža	15.135.169	Latvia	2.013.385
Belgija	11.195.138	Estonija	1.324.612
Mađarska	11.032.328	KTJ	530.046
Češka	10.521.468	Grenland	56.483
Dominik. Rep.	10.403.761		

Kazalo: BR.STAN.2014 – broj stanovnika iz 2014 godine

Analizom tablice 2. vidljiv je prikaz broja stanovnika 69 država koje su osvajale medalje na 34 svjetska taekwon-do prvenstva u periodu od 1987. do 2014. godine. Obzirom na rezultatsku zastupljenost država sa svih 6 kontinenata možemo zaključiti da je taekwon-do globalno rasprostranjen sport koji se vježba u svim krajevima svijeta.

U tablici 3. prikazani su rezultati bodovne uspješnosti država na svjetskim prvenstvima u taekwon-do-u (1987-2014) počevši od najuspješnije.

Tablica 3. Rang lista bodovne uspješnosti država

DRŽAVA	Z	S	B	UKUPBOD	DRŽAVA	Z	S	B	UKUPBOD
Korea	315	76	69	2502	Južna Afrika	6	7	7	70
Argentina	182	161	260	2017	Brazil	4	7	15	64

Rusija	95	126	120	1163	Grenland	3	7	17	59
Engleska	101	98	148	1149	Malezija	3	7	16	58
Poljska	93	91	105	1029	Mongolija	3	5	13	49
Kanada	73	84	207	970	KTJ	4	4	9	49
USA	72	74	184	910	Paragvaj	2	8	5	43
Češka	40	64	100	572	Čile	2	3	8	31
Novi Zeland	51	43	63	549	Estonija	0	7	10	31
Tajikistan	34	41	80	441	Kina	2	2	4	24
Australija	32	23	90	383	Venecuela	1	2	5	18
Irska	33	26	59	368	Belgija	1	1	7	17
Japan	31	27	34	332	Turkmenistan	0	3	7	16
Njemačka	26	29	51	320	Honduras	0	1	10	13
Slovenija	28	21	42	301	Litva	0	3	2	11
Ukraina	17	24	92	283	Austrija	1	0	1	8
Grčka	19	23	63	265	Gruzija	0	2	2	8
Italija	19	21	56	252	Taivan	1	0	1	8
Uzbekistan	11	36	45	230	Urugvaj	1	0	1	8
Škotska	15	17	40	196	Indija	0	1	4	7
Nizozemska	18	11	23	182	Kolumbia	0	1	2	5
Bugarska	12	17	44	179	Vijetnam	0	1	1	4
Kazahstan	9	20	47	170	Švicarska	0	0	4	4
Norveška	14	10	36	164	Jamajka	0	0	3	3
Puerto Rico	13	15	28	164	Francuska	0	1	0	3
Kirgistan	7	21	22	134	Nikaragua	0	0	3	3
Finska	12	6	25	127	Kambodža	0	0	3	3
Španjolska	7	13	26	114	Singapur	0	0	3	3
Croatia	9	8	18	105	Albanija	0	0	2	2
Moldavija	9	8	16	103	Latvia	0	0	1	1
Švedska	5	6	47	100	V. Britanija	0	0	1	1
Rumunjska	4	13	17	84	Peru	0	0	1	1
Mađarska	4	12	15	79	El Salvador	0	0	1	1
Bjelorusija	7	4	18	79	Domini. Re- publika	0	0	1	1
Wales	4	10	15	73					

Kazalo: Z - br. zlatnih medalja, S - broj srebrnih medalja, B - br. brončanih medalja, UKUPBOD – ukupan broj bodova (7 - zlato, 3 - srebro, 1 - bronca)

Analizirajući rezultate tablice 3. osvojenih bodova na svjetskim taekwon-do prvenstvima od 1987. do 2014. godine možemo zaključiti da se na prvom mjestu nalazi Sjeverna Koreja sa 2502 bodova te da je poredak prvih trinaest država identičan neovisno dali gledamo broj bodova ili broj osvojenih zlatnih medalja.

U tablici 4. prikazani su rezultati bodovne uspješnosti država na svjetskim prvenstvima u taekwon-do-u (1987-2014) prema federacijama.

Tablica 4. Rang lista bodovne uspješnosti država po federacijama (1 federacija - „ITF Vienna“, 2. federacija - „ITF Roma“, 3. federacija - „Orthodox ITF“)

1.FEDERACIJA			2.FEDERACIJA		3.FEDERACIJA	
RANG	DRŽAVA	UKUPBODB	DRŽAVA	UKUPBOD	DRŽAVA	UKUPBOD
1.	Korea	1148	Poljska	677	Argentina	1100
2.	Rusija	737	N. Zeland	521	Engleska	697
3.	Tajikistan	351	Argentina	500	USA	621
4.	Češka	335	Kanada	265	Kanada	367
5.	Engleska	268	Njemačka	205	Australija	242
6.	Japan	213	Irska	184	Rusija	176
7.	Ukraina	208	Slovenija	179	Italija	170
8.	Bugarska	161	USA	141	Irska	134
9.	Grčka	153	Rusija	114	Japan	95
10.	Argentina	136	Engleska	108	Škotska	79

Kazalo: UKUPBOD – ukupan broj bodova (7 - zlato, 3 - srebro, 1 - bronca)

Tablica 4. konstruirana je uvažavajući činjenicu da se ITF taekwon-do 2002. podijelio na tri federacije od kojih je prva broji 127 članova, druga 84 člana i treća 41. Analizirajući rezultate prikazane u tablici 4 vidljivo je da svaka od federacija ima drugačiji poredak država po uspješnosti. Velika raznovrsnost poretka država proizlazi iz činjenice da neke države ne nastupaju u sve tri federacije odnosno pojedine federacije nisu jednako rasprostranjene unutar države. Kao iznimke možemo izdvojiti Rusiju i Englesku koje su se našle među prvih 10 u sve tri federacije.

U tablici 5. prikazana je korelacijska analiza odnosa broja stanovnika i ukupnog broja bodova po pojedinačnim federacijama.

Tablica 5. Korelacijska analiza po federacijama (1 federacija - „ITF Vienna“, 2. federacija - „ITF Roma“, 3. federacija - „Orthodox ITF“)

	1. FEDERACIJA	2. FEDERACIJA	3. FEDERACIJA
BR.STAN/UKUPBOD	0,81*	0,46*	0,01

Kazalo: BR.STAN./UKUPBOD- povezanost broja stanovnika u milijunima i ukupnog broj bodova

Analizom tablice 5. promatrana povezanost broja stanovnika i uspješnosti po federacijama možemo uočiti kako prve dvije koje su i znatno brojnije od treće pokazuju statistički značajnu povezanost (0.81, 0.46) dok kod treće federacije to nije slučaj(0.01). Time možemo zaključiti kako veći broj stanovnika doprinosi i većem broju mogućih natjecatelja, odnosno talenata koji bi mogli ostvariti rezultate u ovom sportu.

U tablici 6. prikazana je rang lista relativne bodovne uspješnosti država na svjetskim prvenstvima u taekwon-do-u ITF načinom (1987-2014).

Tablica 6. Rang lista relativne bodovne uspješnosti država (ukupan broj bodova na milion stanovnika)

DRŽAVA	KOEF	DRŽAVA	KOEF
Grenland	1044,56	Rumunjska	4,21
Slovenija	146,08	Njemačka	3,97
Novi Zeland	122,80	Litva	3,72
Korea	100,50	Turkmenistan	3,05
KTJ	92,44	USA	2,88
Irska	80,08	Japan	2,61
Češka	54,37	Španjolska	2,44
Tajikistan	53,73	Urugvaj	2,35
Argentina	48,67	Malezija	1,95
Puerto Rico	45,37	Gruzija	1,79
Škotska	37,02	Čile	1,76
Norveška	32,26	Honduras	1,61
Moldavija	28,94	Belgija	1,52
Kanada	27,59	Južna Afrika	1,32
Grčka	26,78	Jamajka	1,10
Poljska	26,71	Austrija	0,94
Croatia	24,69	Albanija	0,72
Bugarska	24,64	Venecuela	0,59
Wales	23,83	Singapur	0,56

Kirgistan	23,43	Latvia	0,50
Estonija	23,40	Švicarska	0,49
Finska	23,35	Nikaragua	0,49
Engleska	21,67	Taivan	0,34
Mongolija	17,26	Brazil	0,32
Australija	16,56	Kambodža	0,20
Nizozemska	10,83	El Salvador	0,16
Švedska	10,42	Kolumbia	0,10
Kazahstan	9,98	Dominik. Rep.	0,10
Bjelorusija	8,35	Francuska	0,05
Rusija	8,10	Vijetnam	0,04
Uzbekistan	7,61	Peru	0,03
Mađarska	7,16	Kina	0,02
Paragvaj	6,32	V. Britanija	0,02
Ukraina	6,22	Indija	0,01
Italija	4,21		

Kazalo: KOEF = (UKUPNO BODOVA / BROJ STANOVNIKA) * 1.000.000

Analizirajući tablicu 5. na kojoj je prikazana rang lista relativne bodovne uspješnosti država koje su ostvarile rezultate na svjetskim taekwon-do prvenstvima (1987-2014.) vidljivo je da koeficijent proizlazi iz omjera ukupnih bodova i broja stanovnika pomnožen sa milijun. Najveći koeficijent i prva mjesta na tablici zauzimaju države sa relativno malim brojem stanovnika. Pri tome odskače Grenland sa koeficijentom 1044,56 što je u direktnoj vezi sa relativnom malom populacijom od 56.463.stanovnika. Četvrto mjesto rang liste koje je unatoč relativno veliko populaciji zauzela Sjeverna Koreja govori o njenoj kvaliteti i uspješnosti na svjetskim natjecanjima.

U tablici 7. prikazana je korelacijska analiza između uspješnosti država na svjetskim prvenstvima u taekwon-do-u i veličine populacije (broja stanovnika).

Tablica 7. Korelacijska analiza (*neparametrijski test - Spearman Rank Order Correlations*)

	BR.STAN.	UKUPBOD	KOEF
BR.STAN.	1,00	0,21*	-0,40
UKUPBOD	0,21*	1,00	0,77
KOEF.	-0,40	0,77	1,00

Kazalo: BR.STAN- ukupan broj stanovnika u milijunima, UKUPBOD – ukupan broj bodova, KOEF – omjer ukupnog broja bodova na milion stanovnika

Dosadašnja istraživanja pokazala su povezanost između *veličine populacije države i osvojenih medalja na sportskim natjecanjima*. Veći broj stanovnika povećava mogućnost postojanja većeg broja talenata i osvajača medalja. Analiza rezultata primjenjene korelacijske analize (*neparametrijski test - Spearman Rank Order Correlations*) prikazih u tablici 7. u skladu sa dosadašnjim istraživanjima predmetne problematike potvrđuje da postoji statistički značajna povezanost između uspješnosti država na svjetskim prvenstvima u taekwon-do-u i veličine populacije tj. broja stanovnika. Ujedno je utvrđeno je da na razini značajnosti $p < 0,05$, postoji (0,21*) statistički značajna povezanost između uspješnosti država na svjetskim prvenstvima i veličine populacije tj. broja stanovnika pojedine države.

ZAKLJUČAK

Temeljem dobivenih rezultata utvrđen je redoslijed (rang) generalne uspješnosti država po broju ukupno osvojenih bodova na svjetskim prvenstvima od 1987. - 2014. godine (1. Koreja = 2502, 2. Argentina = 2017, 3. Rusija = 1163, 4. Engleska = 1149, 5. Poljska = 1029...). Temeljem izračuna koeficijenta relativne uspješnosti država (UKUBOD/ POPUL) u odnosu na veličinu populacije (*broj bodova na milion stanovnika*) utvrđen je relativni redoslijed (rang) uspješnosti država (1. Grenland = 1044,56 2. Slovenija = 146,08, 3. Novi Zeland = 122,80, 4. Koreja = 100,50, 5. KTJ = 92,44...). Analizirani su rezultati 69 država sa 6 kontinenata što upućuje na zaključak da je taekwon-do u svjetskim razmjerima globalno gledano, relativno razvijen sport. Prikazanih rezultati pokazuju da je generalno gledano najuspješnija država S. Koreja koja i u relativnom redoslijedu zauzima visoko četvrto mjesto. Rezultat i nije iznenađujući s obzirom da je S. Koreja kolijevka taekwon-do-a ali i danas taekwon-do je dio života obrazovanja i tradicije u Koreji.

Uzevši u obzir pokazatelje relativne uspješnosti najuspješnija država je Grenland koja znatno odudara od ostalih država po broju stanovnika (56.483) pa i relativno malen broj medalja (UKUPBOD- 59) daje visok koeficijent (1044,56) i plasman na rang listi..

Primjenom korelacijske analize utvrđeno je da na razini značajnosti $p < 0,05$ postoji određena (0,21) statistički značajna povezanost između uspješnosti država na svjetskim prvenstvima i veličine populacije tj. broja stanovnika pojedine države. Kako i u dosadašnjim istraživanjima o utjecaju populacije na uspješnost država u sportu tako je i u ovom radu potvrđena veza spomenutih varijabli. Veća država tj. veći broj stanovnika dovodi do veće vjerojatnosti postojanja talentiranih sportaša.

This work has been supported by the Croatian Science Foundation under the project number [6524].

LITERATURA

Bernard, A., & Busse, M.R. (2004), Who wins the Olympic Games: Economic resources and medal totals, *Review of Economics and Statistics*, 86, 413-417.

Bian, X. (2005), Predicting Olympic Medal Counts: The Effects of Economic Development on Olympic Performance, *The Park Place Economist*, XIII, 37-44.

Čular, D., Krstulović, S., Katić, R., Primorac, D., & Vučić, D. (2013). Predictors of fitness status on success in taekwondo. // *Collegium antropologicum*, 37(4), 1267-1274

Johnson, D. K. N., & Ali, A. (2000), Coming to play or coming to win: Participation and success at the Olympic Games (Working paper). *Department of Economics, Wellesley College, Wellesley, MA.*

Marković, G., Mišigoj-Duraković, M., & Trninić, S. (2005). Fitness profile of elite croatian taekwondo athletes, *Collegium Antropologicum*, 29(1) 93-99.

<http://www.tkd-itf.org/pagina.php?idpag=1120&web=47&lng=3>

[http://sonkal.taekwondo.cz/dokumenty/2003-13.World_Seniors_Championship-Protocol\(short\).pdf](http://sonkal.taekwondo.cz/dokumenty/2003-13.World_Seniors_Championship-Protocol(short).pdf)

http://www.taekwon-do.nl/documenten/1_WK_ITF_2007.pdf

<http://www.fitespain.com/documentacion/201109OfficialResults.pdf>

http://issuu.com/itfcaribe/docs/2013_twc_overall_results/1?e=2789303/4182372

<http://www.itf.taekwondo.hr/docs/taekwondoHR/documents/41/Original.pdf>

http://taekwondo.cz/dokument/2012_msjv_vysledky.pdf

<http://www.itftkd.org/?n=news&p=1&nr=22>

http://www.itfsweden.com/resultat/vm_2005_resultat.htm

<http://www.itftaekwondo.com/worlds2006/categories.htm>

<http://www.itf-administration.com/articles.asp?arturn=863>

<http://www.itf-administration.com/articles.asp?arturn=1931>

<http://media.wix.com/>

ugd/09c0e9_57fcdc7ce3b84406a64add20164ad851.pdf

<http://www.itf-administration.com/news.asp?nurn=9716&pg=1>

<http://www.itf-administration.com/news.asp?nurn=9715&pg=1>

http://en.wikipedia.org/wiki/Demography_of_England

http://en.wikipedia.org/wiki/Demographics_of_Scotland

http://en.wikipedia.org/wiki/Demographics_of_Wales
http://en.wikipedia.org/wiki/Demographics_of_Japan
http://taekwondo.cz/dokument_legislativa/informace_o_ITF.pdf
http://www.itftkd.org/pics/texte/ITF_Tournament_Rules__092014.pdf
<http://www.tkd-itf.org/wp-content/uploads/2014/10/ITF-World-Junior-Senior-Tournament-Rules-feb-8-In-force-of-January-1st-2013.pdf>
<http://www.topendsports.com/events/summer/medal-tally/rankings-weighted-athletes.htm>

Influence of certain motor skills on the execution of judo throwing technique morote sei nage

Goran Mickoski¹, Stipe Blazevic², Žarko Kostovski³

¹ *Judo Federation of Macedonia*

² *Faculty of Economics, University of Rijeka, Croatia*

³ *University St. Cyril and Methodius, Faculty for Physical Education Sport and Health – Skopje, Macedonia*

ABSTRACT

The research covers 60 judokas aged 15-17 years. 18 tests are applied, as predictor variable system, which are hypothetically used for assessment of basic motor skills: segmental speed, flexibility, explosive strength, repetitive strength, balance and coordination. Judo technique "Morote Seoi nage" is used as criterion variable. The aim of the research was to determine the influence of criterion system of motor variables on situation-motor variable morote sei nage. Data obtained by the research are processed and basic statistical parameters and linear regression analysis are shown. The results indicate that there is a high and statistically significant prediction between predictor system of motor variables and judo throwing technique "Morote sei nage". There is a partial influence at the Hand Tapping for 10 seconds variable, which represents the variables for assessment of speed of segmental movements.

Keywords: Morote sei nage, judo, linear regression analysis

INTRODUCTION

There is a significant increase in researches of martial sports, such is judo, in the sphere of analysis of technical and tactical dynamics which helps the development of specific training programs for the athletes (Courel et al 2014; Miarka et al 2014). In order to grant the same scope of work for all athletes, information on level of technical preparation, registry of important data on

which the upgrade of training process depend, various software applications are developed, such is the LINCE software, (Gabín et al 2012). Judo is an Olympic sport in which it is very difficult to predict which athlete will be the best in a big competition, such are the Olympic Games. Not a single winner from Beijing did not won the gold medal in London, while 45 of 56 medal winners won their first Olympic medals in London. That leads to conclusion that in order to progress in a career, every judoka should employ various methods, software, analyses, tests which will show the condition of the judoka or the relation between certain indicators which should be improved in order to improve technical and tactical fitness of a top judoka. Many authors explored the relations between morphological properties and situation and motor tests and some of them determined the influence of basic motor skills on successful performance on some situation and motor tests (Zeljko et al 2012, Mickoski et al 2014). Some of them compared the results obtained from basic motor tests and situation motor tests between two groups (Kostovski et al 2012), while some of them determined the structure of motor skills among young judokas (Nurkic et al 2012). In order to better determine the influence of motor skills on situation motor tests, some authors conducted survey among top coaches aiming to rank the importance of motor skills which influence situation motor tests (Krstulović, 2012).

METHODS

This research was conducted in order to determine the influence of certain basic motor skills on situation motor technique Morote seoi nage, in judo among young judokas. The research covers a sample of 60 young male judokas aged 15-17 years (cadet category). Respondents have been training for at least two years and all of them have competed at the state championships in Republic of Macedonia. 18 predictor variables are used in this research in order to assess the basic motor skills among young judokas and 1 criterion variable for assessment of situation motor skills. The research follows the recommendations of Kurelić et al. (1975), Metikoš et al. (1989) and Kostovski (2004). Variables for assessment of basic motor space were divided in 6 subspaces as follows: speed of segmental movements, Hand Tapping for 10 seconds (MTAPR10), Foot Tapping for 10 seconds in a frontal plane (MTAPNFR10) and Foot Tapping for 10 seconds in a sagittal plane (MTAPNSR10), flexibility:

Deep forward bend on a bench (MPRKL), Shoulder flex with a bat (MISP) and Man split (MSHPM), explosive strength: Standing long jump (MSDM), High jump from a spot (MSVM) and Throwing a medicine ball forward in a supine position (MFMLGN), repetitive strength: Raising body from a back lying position (MPTLG), Raising body from lying on stomach (MPTLS) and Push-ups on the floor (MSKP), balance: Balance on inner hemisphere (MRPTV), Balance on external hemisphere (MRPTN), Balance on external hemisphere with eyes closed (MRPTNZO), coordination: Agility in the air (MOVV), Agility with a bat (MOSP) and Agility on the ground (MOKTLO). The criterion test Morote seoi nage (SMMSN) was used in order to determine the influence of basic motor variables on performance of the judo technique. The variable for assessment of situation motor skills was selected as a result of the analysis performed by the European Judo Federation (EJU) with the help of "Match Analysis Process" for men competitions at the last Summer Olympic Games in London in 2012. Nage Waza was selected as a variable sample of the best 5 (five) throwing techniques according to the performance efficiency illustrated by the analysis.

During statistical processing of the results, basic descriptive statistical parameters were calculated for all variables: The following descriptive statistical parameters were calculated for all variables during the statistical processing of the results: Arithmetic Mean (mean); Standard Deviation (Std. Dev); Minimum and Maximum range of results (min – max); Symmetry of the results distribution for assessment of test difficultness, whether it is difficult or not among the respondents sample (Skew); Roundness of results distribution for determining homogeneity of results obtained from a certain test (Kurt); Kolmogorov–Smirnov test for determining normal distribution of the results (K-S); as well as the Pearson coefficient of correlation for determining relation between the variables (r).

Linear regression analysis is applied in order to determine the predictor variable system on the criterion variable. StatSoft Statistica 10 Enterprise and Excel for Windows were used for the statistical processing.

RESULTS AND DISCUSSION

Table 1 shows data about basic motor descriptive statistical parameters among respondents-Judokas ($N = 60$). The following parameters are calculated for this research: arithmetic mean (Mean), minimal result (Min), maximal

result (Max), standard deviation (Std.Dev.). For testing the normality of the distribution of the results: coefficient of asymmetry of the results (Skew), coefficient of elongation (flatness) of the results (Kurt) and Kolmogorov-Smirnov method (max D).

Table 1 - Descriptive statistical parameters of basic motor variables

	Valid N	Mean	Min	Max	Std. Dev.	Skew	Kurt	K-S	p
MTAPR10	60	22,63	17,00	31,00	3,17	0,43	-0,27	0,13	p > .20
MTAPNFR10	60	13,73	10,00	19,00	1,84	0,41	0,12	0,12	p > .20
MTAPNSR10	60	11,42	8,00	15,00	1,67	-0,02	-0,59	0,12	p > .20
MPRKL	60	28,23	15,00	44,00	6,80	0,10	-0,55	0,08	p > .20
MISP	60	82,30	50,00	129,00	15,51	0,56	0,24	0,10	p > .20
MSHPM	60	178,08	148,00	203,00	11,44	0,11	-0,09	0,08	p > .20
MSDM	60	199,39	146,00	250,00	27,63	-0,12	-0,81	0,11	p > .20
MSVM	60	37,38	20,00	65,00	7,64	0,77	2,21	0,13	p > .20
MFMLGN	60	6,48	4,35	9,50	1,18	0,26	-0,52	0,08	p > .20
MPTLG	60	34,63	8,00	80,00	17,30	0,74	0,19	0,11	p > .20
MPTLS	60	43,37	6,00	101,00	23,33	0,54	-0,41	0,12	p > .20
MSKP	60	24,63	6,00	100,00	14,98	2,45	10,08	0,14	p < ,20
MRPTV	60	7,18	0,00	27,00	6,12	1,05	0,66	0,18	p < ,05
MRPTN	60	6,53	0,00	27,00	6,97	1,49	1,40	0,23	p < ,01
MRPTNZO	60	18,79	2,00	44,00	10,84	0,25	-0,95	0,11	p > .20
MOVV	60	5,19	3,37	7,57	0,96	0,52	0,17	0,10	p > .20
MOSP	60	10,13	5,10	20,10	3,04	0,89	2,07	0,09	p > .20
MOKTLO	60	18,97	12,00	33,00	4,71	0,94	0,49	0,13	p > .20

Analysis of the results presented in the table 1 shows the following: compared to the previous researches, the results obtained in this research are within the expected framework (Kostovski et al 2012, Mickoski & Kostovski 2013.)

The asymmetry of the results values (Skew) has statistically significant deviations in variables: Push-ups on the floor (MSKP, Skew = 2,45), Balance on

inner hemisphere (MRPTV, Skew = 1,05) and Balance on external hemisphere (MRPTN, Skew = 1,49). The degree of the curvature of the top curve (Kurt), has statically significant deviation in the variable Push-ups on the floor (MSKP, Kurt = 10,08). Based on the results obtained by the coefficient of normal distribution of results (max D), it can be concluded that statistically significant deviation at the level of $p < ,05$ can be noted in 1 (one) motor variable, while statistically significant deviation at the level of $p < ,01$ can be noted in 1 (one) variable. Deviation of $p < ,05$ can be noted in the variable: Balance on inner hemisphere (MRPTV), while deviation of $p < ,01$ can be noted in the following variable: Balance on external hemisphere (MRPTN).

Table 2 - Descriptive statistical parameters of Morote seoi nage variable

	Valid N	Mean	Min	Max	Std.Dev.	Skew	Kurt	K-S	p
SMMSN	60	3,53	1,66	5,00	0,78	-0,39	-0,03	0,12	$p > .20$

Analysis of the results presented in the table 1 shows the following:

The asymmetry of the results values (Skew) has no statistically significant deviations in the variable. The same applies for the degree of the curvature of the top curve (Kurt), in which there are also no statistically significant deviations in the results. From the analysis of the results obtained for the coefficient of normal distribution of results (max D), it can be concluded that in the situation motor variable Morote seoi nage there is no statistically significant deviation of distribution of the results at the level of $p < ,05$ and $p < ,01$.

Table 3 shows Pearson correlation coefficients of applied motor variables among judokas. The size of the sample is the reason for the significant correlation coefficients.

General conclusion arising from the analysis of the relations between applied variables is that there is slight relation between applied variables in 16 cases with importance level of $p < 0,01$. Real significant relation can be noted in 22 relations, while high and very high relations are not registered.

For relations between applied variables at the importance level of $p < 0,05$ it can be concluded that there is a slight relation between applied variables in 33 cases. Real significant relation can be noted in 23 relations, while high and very high relations are not registered.

Table 3- Pearson correlation coefficients of basic motor variables

	MTAPR10	MTAPNFR10	MTAPNSR10	MPRKL	MISP	MSHPM	MSDM	MSVM	MFMLGN	MPTLG	MPTLS	MSKP	MRPTV	MRPTN	MRPTNZO	MOVV	MOSP	MOKTLO
MTAPR10	1,00																	
MTAPNFR10	0,36	1,00																
MTAPNSR10	0,44	0,56	1,00															
MPRKL	0,24	0,14	0,26	1,00														
MISP	0,03	-0,24	-0,21	-0,09	1,00													
MSHPM	0,06	0,30	-0,03	0,42	-0,06	1,00												
MSDM	0,22	-0,15	0,18	0,35	-0,05	-0,05	1,00											
MSVM	0,15	0,11	0,17	0,24	0,04	0,09	0,48	1,00										
MFMLGN	0,33	0,30	0,32	0,41	-0,07	0,34	0,33	0,44	1,00									
MPTLG	0,51	0,20	0,55	0,29	-0,02	-0,07	0,50	0,26	0,24	1,00								
MPTLS	0,27	0,23	0,53	0,17	-0,16	-0,05	0,43	0,21	0,26	0,70	1,00							
MSKP	0,25	0,38	0,39	0,22	-0,01	0,09	0,03	0,14	0,19	0,42	0,27	1,00						
MRPTV	-0,03	-0,05	-0,14	-0,42	0,10	-0,24	-0,16	-0,17	-0,36	-0,25	-0,24	-0,28	1,00					
MRPTN	-0,10	-0,14	-0,07	-0,27	0,14	-0,24	-0,14	-0,28	-0,35	-0,07	0,05	-0,23	0,55	1,00				
MRPTNZO	0,36	0,06	0,30	-0,03	0,20	-0,22	0,22	0,06	-0,01	0,50	0,49	-0,03	0,35	0,57	1,00			
MOVV	-0,09	-0,25	-0,33	-0,03	0,26	0,07	-0,04	-0,16	-0,01	-0,09	-0,01	-0,20	0,15	0,17	0,08	1,00		
MOSP	0,00	0,01	0,02	-0,01	0,13	0,12	0,07	0,04	0,21	0,13	0,29	-0,06	-0,20	0,03	0,15	0,41	1,00	
MOKTLO	-0,42	-0,01	-0,39	-0,11	-0,04	0,00	-0,45	-0,26	-0,40	-0,54	-0,52	-0,03	0,13	0,21	-0,35	-0,24	1,00	
																		1,00

Table 4 – Regression analysis of Morote seoi nage

	b*	Std.Err. - of b*	b	Std.Err. - of b	t(41)	p-value
Intercept			4,79	2,19	2,19	0,03
MTAPR10	0,41	0,14	0,10	0,03	2,94	0,01
MTAPNFR10	0,08	0,17	0,03	0,07	0,46	0,65
MTAPNSR10	-0,15	0,17	-0,07	0,08	-0,87	0,39
MPRKL	-0,24	0,14	-0,03	0,02	-1,69	0,10
MISP	-0,02	0,12	0,00	0,01	-0,15	0,89
MSHPM	-0,11	0,13	-0,01	0,01	-0,79	0,43
MSDM	0,26	0,15	0,01	0,00	1,67	0,10
MSVM	0,01	0,13	0,00	0,01	0,10	0,92
MFMLGN	-0,24	0,15	-0,16	0,10	-1,65	0,11
MPTLG	-0,19	0,20	-0,01	0,01	-0,92	0,37
MPTLS	0,24	0,19	0,01	0,01	1,27	0,21
MSKP	0,11	0,13	0,01	0,01	0,85	0,40
MRPTV	-0,15	0,17	-0,02	0,02	-0,90	0,37
MRPTN	-0,35	0,18	-0,04	0,02	-1,97	0,06
MRPTNZO	-0,23	0,21	-0,02	0,01	-1,12	0,27
MOVV	-0,27	0,14	-0,22	0,11	-1,97	0,06
MOSP	0,04	0,13	0,01	0,03	0,31	0,76
MOKTLO	0,00	0,17	0,00	0,03	-0,01	0,99

R = ,77	R ² = ,59	F(18,41)=3,24	p < ,01
---------	----------------------	---------------	---------

Table 4 shows the regression analysis of the variable Morote seoi nage (SMMSN) as a criterion and system of motor variables as predictors among judokas. The results show that the multiple correlation coefficient is 0,77, while the explained variability of the common variance is 59%. The correlation between the criterion variable and the system of applied predictor variables is statistically important at the level of $p=0,01$. Significant coefficient of the partial regression at the level of $p=0,01$ has been established for the variable Hand Tapping for 10 seconds (MTAPR10) 0,01, while close coefficients at the importance level of $p=0,05$ can be noted in the variables: Balance on external hemisphere (MRPTN) 0,06 and Agility in the air (MOVV) 0,06.

We can say that such partial influences on criterion variable are not expected considering the performance of the technique itself as well as

motor subspaces for its efficient performance. Similar research was conducted by Mickoski, G & Kostovski, Z. (2013) on situation motor variable *uchi mata*. Regression analysis of the obtained results determined statistically significant influence of motor variables on specific situation motor variable *Uchi Mata*, but in that research, there is a partial participation of four predictor variable which do not coincide with the variables which have partial influence in this research. In the conducted research for determining the influence of motor variables criterion system on specific situation motor variable *Yoko Tomoe Nage* (Mickoski, et. al. 2014) determined that there is a high and statistically significant prediction between the predictor set of motor variables and specific situation motor variable *Yoko Tomoe Nage*. The author also determined that there is a partial influence among represents for assessment of: flexibility of shoulder joint, explosive strength of lower extremities and explosive strength of upper extremities.

CONCLUSIONS

The research covers 60 male judokas in cadet category, from Republic of Macedonia. The aim of the research was to determine the influence of criterion system of motor variables on specific situation and motor variable *morote seoi nage*. 18 motor variables were applied as predictor variable system, and 1 situation motor variable - criterion. The research explored the interrelation of applied variables and determined the influence of predictor variable system on criterion variable, i.e. the linear regression analysis was applied. According to the results obtained from this research, it can be concluded that the predictor variable system has statistically important influence on criterion variable. The test for assessment of the speed of segmental hand movements, "Hand tapping for 10 seconds" (MTAP10) has the biggest partial influence on the criterion variable. This indicates that the selection of the predictor variable system is justified and that improving the basic motor skills creates sound foundation for successful performance of the "*Morote seoi nage*" technique.

REFERENCES

Courel, I., Franchini, E., Femia, P., Stankovic, N., & Escobar-Molina, R. (2014). Effects of kumi-kata grip laterality and throwing side on attack effectiveness and combat result in elite judo athletes. *International Journal of Performance Analysis in Sport*, 14 (1), 138-147.

Miarka, B., Cury, R., Julianetti, R., Battazza, R., Julio, UF., Calmet, M., & Franchini E. (2014). A comparison of time-motion and technical-tactical variables between age groups of female judo matches. *Journal of Sports Sciences*.

Gabín, B., Camerino, O., Anguera, & M.T., Castañer, M. (2012), Lince: multiplatform sport analysis software. *Procedia Computer Science Technology*, 46.

Zeljko, M., Humerovic, D., Ilic, M., & Kostovski, Z. (2012). Relacije morfoloških karakteristika i situacionih kretnih struktura dzudista [Relations of the morphological characteristics and situation movement structure in judo athletes] *Sportske nauke i zdravlje*, 1(2), 141-146.

Mickoski, G., Kostovski, Z. (2013). The impact of basic motor skills on the uchi mata situation motor test in young judo athletes, Subotica, 6th International interdisciplinary scientific professional conference, 367-371

Mickoski, G., Zeljkovic, M., Georgiev, G., & Kostovski, Z., (2014). Predictive values of basic-motor abilities in harai goshi situation motor test with young judo athletes, B. Luka, 4th International Conference on "Sports Science and Health", proceedings, 72-79

Kostovski, Ž., Mikić, B., Kostovska, Z. (2012). *The comparison of anthropological dimensions in the multivariate space with judo sportsmen at the age of 13 to 15 years old. Sportske nauke i zdravlje*, 2 (2), 161-169

Nurkic, M., Lolic, D., & Bratic, M. (2012). Struktura motorickih sposobnosti mladih selekcionisanih dzudista [Structure of the motor skills in young selected judo athletes], *Sportske nauke i zdravlje*, 1(2), 37-46

Krstulović, S. (2012). Predictors of judo performance in male athletes. *Scientific journal of sport and physical education Homosporticus*, 14 (2), 5-10.

Kurelić, N., Momirović, K., Stojanović, M., Šturm, J., Radojević, Đ., & Viskić-Štalec, N. (1975). Struktura i razvoj morfoloških i motoričkih dimenzija omladine. [Structure and development of morphological and motor dimensions in youth], Beograd: Institut za naučna istraživanja Fakulteta za fizičko vaspitanje.

Metikoš D., Prot F., Holman E., Pintar, Ž., & Oreb, G. (1989) *Mjerenje bazičnih motoričkih dimenzija sportaša [Measurement of basic motor dimensions in athletes]*, Zagreb: Fakultet fizičke kulture Sveučilišta u Zagrebu.

Костовски, Р. Ж. (2004) Мерни карактеристики на некои стандардни и специфично моторички тестови применети кај карате спортисти од различна хронолошка возраст. Докторска дисертација, Скопје: Универзитет "Св. Кирил и Методиј", Факултет за физичка култура [Kostovski, R, Z. (2004).

Measurement characteristics of certain standard and specific motor tests applied in karate athletes of different chronological age. PhD Thesis, Skopje: The Ss Cyril and Methodius University, The Faculty of Physical Culture].

Mickoski, G., Georgiev, G., & Kostovski, Z., (2014). Relation between basic motoric tests and judo technique – yoko tomoe nage, 1 ST INTERNATIONAL SCIENTIFIC CONFERENCE Research in Physical Education, Sport, and Health Conference Proceedings, Ohrid, 197-201.

Razlike u kronološkoj, biološkoj i trenažnoj dobi uspješnijih i manje uspješnih mladih odbojkašica

Mirjana Milić¹, Zoran Grgantov¹, Marjeta Mišigoj Duraković², Goran Nešić³, Johnny Padulo⁴

¹Faculty of Kinesiology, University of Split, Croatia

²Faculty of Kinesiology, University of Zagreb, Croatia

³Faculty of Sport and Physical Education, University of Belgrade, Serbia

⁴Università Telematica "E-Campus", Italy

ABSTRACT

On the sample of 204 youth female volleyball players, from all over Croatia, differences between more efficient and less efficient players in the chronological, biological and training age were analyzed. Biological maturity was estimated with non invasive method of Mirwald et al. (2002). According to team placement in the competitions and quality of each player in their team, players were divided into two groups: more efficient and less efficient. Student t-test for independent samples determined that more successful female volleyball players were older, biologically more mature and had longer training age than less successful players. The results indicate the need of recognising the biological and training age in the identification process of gifted young volleyball players, as well as in the long-term planning and programming of development of their talent.

Key words: volleyball, growth and maturation, t-test

UVOD

Rast i sazrijevanje buran je i složen fenomen koji slijedi niz zakonitosti. Ipak, tempo rasta i sazrijevanja individualno je različit. Individualne različitosti u dinamici rasta značajan su izvor varijabilnosti oblika, funkcije i sposobnosti ljudskog tijela posebno tijekom adolescentnog perioda. Djeca koja ranije sazrijevaju su jača, snažnija i brža, imaju bolji aerobni kapacitet i snagu, viša su i imaju veću tjelesnu masu od vršnjaka koji kasnije sazrijevaju (Malina,

2004). Djeca iste kronološke dobi mogu se razlikovati i više od četiri godine u biološkoj zrelosti (Balyi i Williams, 2009). Da biološki zrelija djeca imaju prednost u natjecanjima mlađih dobnih skupina u sportovima u kojima su visina i navedene sposobnosti prednost, i da treneri njihovu bolju izvedbu uzimaju u obzir u procesu selekcije indirektno pokazuje i efekt relativne kronološke dobi tj. razlike u datumu rođenja unutar iste godine. U brojnim istraživanjima tog efekta utvrđeno je da su djeca rođena u prvom dijelu godine češće birana u natjecateljske ekipe u različitim sportovima (Musch i Grondin, 2001). Ako efekt relativne dobi ima utjecaj na odabir djece u natjecateljske ekipe i u početne postavbe tih ekipa, onda se može pretpostaviti da razlike u biološkoj zrelosti imaju još mnogo snažniji utjecaj na proces selekcije. S obzirom da je za usavršavanje tehničko-taktičkih vještina u sportu potrebno puno vremena (Baker i sur., 2003), može se pretpostaviti da i dužina treniranja određenog sporta (trenažna dob) također utječe na trenutnu uspješnost djece na natjecanjima.

Zbog manje vjerojatnosti da budu selekcionirani u natjecateljske ekipe ili u prve postavbe natjecateljskih ekipa biološki nezrelija i trenažno neiskusnija djeca, nerijetko nemaju pristup kvalitetnim treninzima. Zbog toga većina njih ne sudjeluju ili rijetko sudjeluje aktivno na natjecanjima te tako ne stječu ni potrebno igračko iskustvo. Time se stvara svojevrsni začarani krug iz kojeg većina takve djece ne može pronaći izlaz (Schorer i sur., 2009). Konačni efekt je gubitak motivacije i odustajanje od sporta (Figueirido i sur., 2009; Delorme i sur., 2010). Očito je stoga da je uz kronološku dob, potrebno uvažavati tijekom procesa identifikacije darovitih sportaša i biološku i trenažnu dob. To je vrlo važno jer uspješnost u ranim fazama karijere često nije garancija uspješnosti i u seniorskoj konkurenciji (Gagne, 2009; Bailey i Collins, 2013).

I dok se kronološka i trenažna dob lako mogu odrediti iz datuma rođenja i datuma početka bavljenja određenim sportom, većina metoda za izračun biološke dobi (npr. Greulich-Pyle, Tanner-Whitehouse i Fels metoda) su invazivne i (ili) skupe i time neprimjenjive na velikim uzorcima mladih sportaša. Međutim, Mirwald i sur. (2002), koristeći podatke dvaju longitudinalnih studija provedenih na djeci iz kanadske regije Saskatchewan, kao i studije na Belgijskoj djeci, razvili su jednostavnu i neinvazivnu metodu procjene biološke dobi. Ta metoda se bazira na obrascu redoslijeda rasta pojedinih segmenata tijela koji je zajednički svim ljudima i po kojem najprije rastu udovi, a potom trup. Ta metoda zahtijeva samo mjere visine i mase tijela te sjedeće visine, koje služe za izračun dobi najvećeg prirasta u visinu. Temeljem razlika između kronološke

dobi i dobi najvećeg prirasta u visinu izračuna se indikator biološke dobi ispitanika.

U ženskoj odbojci kao i u drugim spotovima natjecateljske dobne kategorije definirane su kronološkom dobi. Imajući na umu značaj relativne kronološke dobi i napose varijabilnosti biološke na definiranje veličine, oblika tijela i funkcionalnih sposobnosti u adolescentnom periodu može se pretpostaviti da su mlade odbojkašice koje imaju više uspjeha na natjecanju starije, biološki zrelije i trenažno iskusnije od manje uspješnih mladih odbojkašica.

Stoga je cilj ovog istraživanja utvrditi postoje li značajne razlike u kronološkoj, biološkoj i trenažnoj dobi između uspješnijih i manje uspješnih odbojkašica mlađih kadetkinja.

METODE RADA

U istraživanju su sudjelovale 204 odbojkašice mlađe kadetkinje iz 17 odbojkaški ekipa s područja cijele Republike Hrvatske Sve odbojkašice bile su članice ekipa koje su sudjelovale na otvorenom Državnom prvenstvu u odbojci 2014 godine, održanom u Rovinju. Kako bi uzorak bio što reprezentativniji uključene su mlade odbojkašice iz svih regija, posebno članice najkvalitetnijih klubova na državnoj razini.

Sve ispitanice imale su natjecateljsku iskaznicu Hrvatske odbojkaše udruge ovjerenu od strane nadležnog sportskog liječnika.

Natjecateljska uspješnost igračica određena je na Likertovoj ljestvici od 1 do 5. Svakoj igračici dodijeljena je ocjena od 1 do 5 s obzirom na dva kriterija: *Plasman ekipe na natjecanju* i *Kvaliteta igračice unutar ekipe (prema procjeni trenera)*. Sve igračice kojima su dodijeljene ocjene od 1 do 3 predstavljale su skupinu manje uspješnih, a sve igračice kojima su dodijeljene ocjene 4 i 5 predstavljale su skupinu uspješnijih prema Grgantov (2005) i Milić (2014).

Ispitane varijable u ovom istraživanju su: *kronološka dob*, *trenažna dob* te *indikator biološke dobi*. *Kronološka dob* izražena je decimalno u godinama temeljem datuma rođenja i datuma testiranja. *Trenažna dob* izražena je decimalno u mjesecima od početka redovitog treniranja do datuma testiranja. Utvrđivanje *dobi (godine) najvećeg rasta u visinu* (eng. *Peak height velocity, PHV*) izvršeno je prema metodi Mirwald i sur. (2002) te je izračunata varijabla *prosječna vrijednost PHV* svih ispitanica. Za potrebe određivanja PHV prema toj metodi korištene su tri antropometrijske varijable: *tjelesna visina*, *sjedeća visina* te *tjelesna masa*. Mjerenja su učinjena prema standardnom protokolu neposredno nakon završetka državnog prvenstva (razdoblje od 3 tjedna). Svaka

antropometrijska varijabla izmjerena je dva puta. Ispitivanje međučestične linearne povezanosti rezultata dvaju mjerenja antropometrijskog skupa od 3 varijable Pearsonovim koeficijentom korelacije, izravno uspoređivanje međučestične koeficijentom varijabilnosti i utvrđivanje njihove homogenosti primjenom Studentovog, t-testa, pokazalo je visoku relativnu i apsolutnu pouzdanost i homogenost mjera svih triju varijabli (Milić, 2014). Stoga je konačni rezultat antropometrijskih varijabli definiran prosječnom vrijednosti dvaju mjerenja. Temeljem odstupanja vrijednosti PHV svakog ispitanika od prosječne PHV svih ispitanika te dodavanjem ili oduzimanjem dobivenih odstupanja od *kronološke dobi*, izračunat je *indikator biološke dobi* mladih odbojkašica.

Metode obrade podataka uključivale su izračun deskriptivnih pokazatelja (aritmetičkih sredina i standardnih devijacija) korištenih varijabli te analize razlika aritmetičkih sredina između unaprijed definiranih podskupina prema kriteriju natjecateljske uspješnosti korištenjem Studentovog, t-testa.

REZULTATI

U tablici 1 prikazani su rezultati deskriptivne statistike: aritmetičke sredine (AS), medijani (M), minimalne (Min) i maksimalne (Max) vrijednosti te standardne devijacije (SD) varijabli: *tjelesna visina*, *sjedeća visina* i *tjelesna masa*.

Metrijska značajka osjetljivost testirana je koeficijentima asimetrije (Skew) i zaobljenosti (Kurt) distribucije. Testiranje normaliteta distribucije izvršeno je Kolmogorov-Smirnovljevim testom čija kritična vrijednost iznosi 0,12 i predstavlja maksimalnu dopuštenu veličinu maksimalne razlike između kumulativnih opaženih i teoretskih relativnih frekvencija.

Tablica 1. Deskriptivni pokazatelji i osjetljivost antropometrijskih varijabli odbojkašica mladih kadetkinja (N=204)

Varijable	AS	M	Min	Max	SD	KS	Skew	Kurt
Tjelesna visina	170,10	170,03	144,35	189,50	7,41	0,04	0,06	0,33
Sjedeća visina	88,55	85,55	76,80	98,80	3,84	0,06	-0,00	-0,01
Tjelesna masa	58,92	58,30	35,35	100,70	9,28	0,11	0,85	2,50
						KS test		
						= 0,12		

Legenda: AS - aritmetička sredina, M - medijan, Min - minimalni rezultat, Max - maksimalni rezultat, SD - standardna devijacija, KS - Kolmogorov-Smirnovljev test, Skew - koeficijent asimetrije distribucije, Kurt - koeficijent zaobljenosti distribucije.

Analiza distribucijskih pokazatelja ukupnog uzorka odbojkašica mlađih kadetkinja Republike Hrvatske pokazuje da ni u jednoj varijabli nema značajnih odstupanja od normalne raspodjele, što znači da su sve varijable pogodne za daljnju multivarijatnu parametrijsku statističku obradu kao i za izračun PHV-a prema Mirwald i sur. (2002).

Na prikazu 1 grafički su predstavljeni rezultati deskriptivnih pokazatelja: aritmetičkih sredina (AS) i standardnih devijacija varijabli: *tjelesna visina*, *sjedeća visina* i *tjelesna masa* manje uspješnih (n=119) i uspješnijih (n=85) odbojkašica mlađe kadetske dobne skupine te analiza razlika prosječnih vrijednosti promatranih varijabli između navedenih podskupina prema kriteriju natjecateljske uspješnosti.

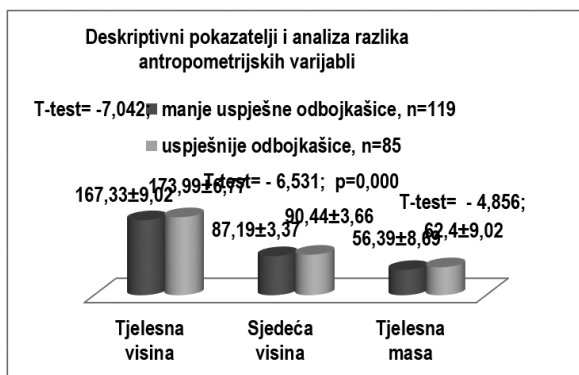

Prikaz 1. Deskriptivni pokazatelji i analiza razlika antropometrijskih varijabli između manje uspješnih i uspješnijih odbojkašica

Grafičkim prikazom vidljivo je da uspješnije odbojkašice imaju višu tjelesnu visinu i sjedeću visinu te da im je veća *tjelesna masa*. Analizom razlika aritmetičkih sredina, korištenjem Studentovog t-testa za nezavisne uzorke, utvrđena je značajna razliku u svim promatranim varijablama prema kriteriju natjecateljske uspješnosti uz nivo značajnosti p=0,000.

U tablici 2 prikazani su deskriptivni pokazatelji odnosno aritmetičke sredine i standardne devijacije varijabli: *kronološka dob*, *indikator biološke dobi* te *trenažna dob* ukupnog uzorka, manje uspješnih i uspješnijih mlađih odbojkašica, kao i rezultati t-testa za nezavisne uzorke definiranih podskupina ispitanica.

Tablica 2. Deskriptivni parametri i analiza razlika varijabli prema kriteriju natjecateljske uspješnosti (N=204)

Varijable	Ukupan uzorak (N=204)	Manje uspješne (N=119)	Uspješnije (N=85)	T test	p
	AS±SD	AS±SD	AS±SD		
Kronološka dob (godine)	14,11±0,84	13,89±0,79	14,43±0,81	-4,77	0,001
Indikator biološke dobi (godine)	14,12±0,76	13,82±0,65	14,53±0,70	-7,51	0,001
Trenažna dob (mjeseci)	42,14±16,17	37,74±15,17	48,29±17,03	-4,65	0,001

Legenda: N - broj ispitanica, AS - aritmetička sredina, SD - standardna devijacija, p - razina statističke značajnosti razlika natjecateljske uspješnosti

Vidljivo je da kronološka dob ispitanica odgovara biološkoj dobi te da su prosječno uključene 3,5 godina u trenažni proces. Manje uspješne mlade odbojkašice su međutim, prosječno značajno kronološki i napose biološki mlađe. K tome, značajno su kraće vrijeme bile podvrgnute odbojkaškom trenažnom procesu od uspješnijih odbojkašica. T-testom za nezavisne uzorke utvrđena je značajna razlika u svim promatranim varijablama prema kriteriju natjecateljske uspješnosti uz nivo značajnosti $p=0,001$.

Na prikazu 2 grafički su predstavljeni rezultati deskriptivne statistike: aritmetičke sredine (AS) i standardne devijacije (SD) varijabli: *kronološka dob*, *indikator biološke dobi* i *trenažna dob* izražena u mjernim jedinicama *godine* manje uspješnih ($n=119$) i uspješnijih ($n=85$) odbojkašica mlađe kadetske dobne skupine.

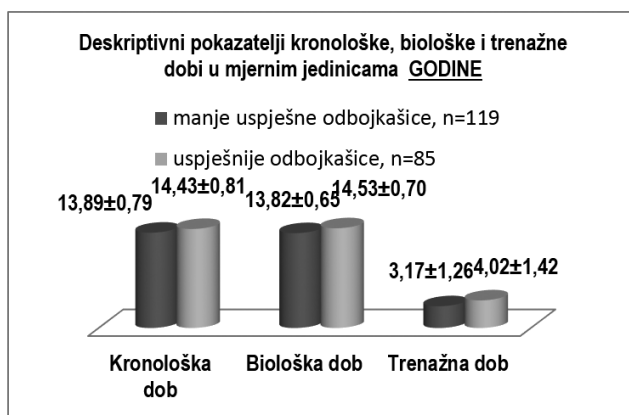

Prikaz 2. Deskriptivni pokazatelji varijabli: *kronološka dob*, *indikator biološke dobi* i *trenažna dob* manje uspješnih i uspješnijih odbojkašica

DISKUSIJA

Rezultati ovog istraživanja ukazuju da su uspješnije mlade odbojkašice kronološki starije, biološki zrelije te da duže treniraju odbojku, odnosno imaju više tjelesnu visinu i sjedeću visinu te veću tjelesnu masu od manje uspješnih suigračica.

Dobiveni rezultati u skladu su s nalazima Maline (2004) koji je utvrdio da sportaši koji ranije sazrijevaju ostvaruju prednost nad svojim vršnjacima na natjecanjima temeljem veće jakosti, snage i brzine. Veća tjelesna visina biološki zrelijim odbojkašicama također može omogućiti prednost na natjecanjima mlađih dobnih skupina, naročito u fazama igre kojima se i osvaja najviše poena a to su smeč, blok i servis (Grgantov, 2005).

Brojni autori (npr. Baker i sur., 2003) ukazuju da je za usavršavanje tehničko-taktičkih vještina u sportu potrebno duže vremensko razdoblje (otprilike 10 godina i 10000 sati treninga). Zbog toga se može pretpostaviti da su mlade odbojkašice koje duže treniraju, u tehničko-taktičkom smislu u prednosti u usporedbi sa suigračicama koje su kasnije počele trenirati odbojku.

Balyi i Williams (2009) ukazuju da uspješniji mladi sportaši često dobivaju više pohvala i priznanja od svojih trenera, obitelji i prijatelja. S druge strane, mladim sportašima koji kasnije sazrijevaju i (ili) koji kraće treniraju određeni sport nedostaje podrške i priznanja okoline. Može se pretpostaviti da se slično događa i s ispitanicama u ovom istraživanju. Usprkos tome što naporno treniraju, biološki mlađe i trenažno neiskusnije odbojkašice ne mogu se nositi s većim i snažnijim biološki zrelijim suigračicama, kao ni s onima koje su zbog dužeg treniranja bolje usavršile tehniku i taktiku odbojke. Posljedica svega navedenog može biti gubitak motivacije i odustajanje od sporta djece koja kasnije sazrijevaju i vremenski manje treniraju određeni sport (Schorer i sur., 2009; Figueirido i sur., 2009; Delorme i sur., 2010).

Vrlo je važno da su treneri koji vježbaju mlade odbojkašice svjesni kako uspjeh u mlađim dobnim skupinama nije garancija uspjeha u kasnijim fazama karijere, a naročito u seniorskoj konkurenciji (Gagne, 2009; Bailey i Collins, 2013). Naime, neke osobine, sposobnosti i znanja koje dobro razlikuju uspješnije od manje uspješnih seniorskih sportaša do izražaja dolaze tek nakon sazrijevanja. Npr. Paerson i sur. (2006) ističu da su antropometrijska mjerenja, kao i testiranja motoričkih i funkcionalnih sposobnosti važna u prvim fazama karijere kada se darovitost sportaša ne može još procijeniti razinom tehničko-taktičkih znanja ili psiholoških vještina. Međutim, u kasnijim fazama karijere natjecateljska uspješnost sve više ovisi o razini tehničko-taktičkih vještina, nekim kognitivnim sposobnostima (percepcija, donošenje odluka) i psihološkim vještinama.

Upravo zbog toga i djeca koja ranije sazrijevaju mogu se naći u opasnosti od gubitka motivacije i odustajanja od sporta nešto kasnije u karijeri kada ih vršnjaci koji su prosječno ili nešto kasnije sazreli sustignu, a često i prestignu u razini sportske izvedbe na natjecanjima. Biološki zrelija djeca često se u svojoj izvedbi pretjerano oslanjaju na prednosti u građi tijela te u motoričkim i funkcionalnim sposobnostima, pri tome zanemarujući usavršavanje tehnike i taktike odabranog sporta (Lawrence, 1999). Očito je da treneri mlađih dobnih skupina imaju vrlo važnu ulogu u prepoznavanju i preveniranju prethodno navedenih neželjenih situacija. Zbog toga je vrlo važno u procesu identifikacije darovitosti uzimati u obzir i biološku i trenažnu dob djece. Osim u procesu identifikacije darovitosti, praćenje biološke zrelosti i trenažnog iskustva je važno i u procesu razvoja talenta s ciljem dostizanja maksimalnih potencijala svake mlade odbojkašice. Pri tome je ključni zadatak definiranje senzitivnih razdoblja za razvoj pojedinih motoričkih i funkcionalnih sposobnosti. Očito je da se senzitivna razdoblja trebaju definirati za svaku sportašicu posebno, ovisno o njezinoj biološkoj dobi. Zbog toga se i prilikom izrade programa za razvoj kondicijskih sposobnosti treba uvažavati biološka zrelost sportašica.

ZAKLJUČAK

Kronološka i biološka dob te trenažni staž značajno definiraju razlike između natjecateljski uspješnijih i manje uspješnih adolescentnih odbojkašica. Početak adolescentnog zamaha rasta i godina najvećeg prirasta u visinu značajne su odrednice individualnog planiranja treninga, oporavka i režima natjecanja mladih sportašica. Stoga je praćenje rasta i sazrijevanja prije, tijekom i nakon puberteta od iznimne važnosti za trenere kako bi mladim sportašima mogli kreirati individualizirane programe treninga, natjecanja i oporavka s ciljem njihova što kvalitetnijeg dugoročnog razvoja.

LITERATURA

Bailey, R., & Collins, D. (2013). The Standard Model of Talent Development and Its Discontents. *Kinesiology Review*, 2, 248-259.

Balyi, I., & Williams, C. (2009). *Coaching the young developing performer*. Leeds: Coachwise.

Baker, J., Horton, S., Robertson-Wilson, J., & Wall, M. (2003). Nurturing sport expertise: Factors influencing the development of elite athlete. *Journal of Sports Science and Medicine*, 2(1), 1-9.

Delorme, N., Boiché, J., & Raspaud, M. (2010). Relative age and dropout in French male soccer. *Journal of sports sciences*, 28(7), 717-722.

Figueiredo, A.J., Goncalves, C.E., Silva, M.J.C.E., & Malina, R.M. (2009). Characteristics of youth soccer players who drop out, persist or move up. *Journal of Sports Science*; 27(9), 883-891.

Gagné, F. (2009). Building gifts into talents: Detailed overview of the DMGT 2.0. In B. MacFarlane, & T. Stambaugh, (Eds.), *Leading change in gifted education: The festschrift of Dr. Joyce VanTassel-Baska*. Waco, TX: Prufrock Press.

Lawrence, M. (1999). *US Swimming Sport Science Summit*. Colorado Springs.

Malina, R.M., Eisenmann, J.C., Cumming, S.P., Ribeiro, B., & Aroso, J. (2004). Maturity-associated variation in the growth and functional capacities of youth football (soccer) players 13 – 15 years. *European Journal of Applied Physiology*. 91(5-6), 555-562

Mirwald, R.L., Baxter-Jones, A.D.G., Bailey, D.A., & Beunen, G.P. (2002). An assessment of maturity from anthropometric measurements. *Medicine and Science in Sports and Exercise*, 34(4), 689-694

Musch, J., & Grondin, S. (2001). Unequal competition as an impediment to personal development: A review of the relative age effect in sport. *Developmental Review*, 21, 147-167.

Pearson, G.A., Naughton, A.G., & Torode, M. (2006). Predictability of physiological testing and the role of maturation in talent identification for adolescent team sports *Journal of Science and Medicine in Sport*, 9(4), 277-287.

Schorer, J., Baker, J., Büsch, D., Wilhelm, A., & Pabst, J. (2009). Relative age, talent identification and youth skill development: Do relatively younger athletes have superior technical skills. *Talent Development and Excellence*, 1(1), 45-56.

Grgantov, Z. (2005). *Identifikacija morfoloških i motoričkih sklopova odbojkašica u odnosu prema uzrastu i situacijskoj učinkovitosti*. Doktorska disertacija. Zagreb: Kineziološki fakultet Sveučilišta u Zagrebu.

Milić, M. (2014). *Međupozicijske i unutarpozicijske razlike mladih odbojkašica u nekim antropoloških obilježjima*. Doktorska disertacija. Split: Kineziološki fakultet Sveučilišta u Splitu.

http://taurus.usask.ca/growthutility/phv_ui.cfm?type=2, lipanj, 2014.

Yo-yo test kao prediktor uspješnosti rukometaša

Tea Bešlija, Mario Tomljanović, Ana Kezić, Jakov Previšić

Faculty of Kinesiology, University of Split, Croatia

ABSTRACT

The aim of this paper is to determine differences in functional abilities between handball players of different quality and ages. This paper covers Yo Yo1 and Yo-Yo 2 Intermittent Recovery test which are able to estimate the degree of preparedness of the functional abilities of team sports players which corresponds to games with intermittent training loads. The sample consisted of 78 handball players of different ages and qualities which were divided into 4 groups due to their quality. MANOVA has been used to determine differences among groups and results showed there is no statistically significant differences between any of the groups in both tests. The differences between groups were not determined probably because the groups were at different stages of training. According to previous research these tests can be used for the selection of young players.

UVOD

Kondicijska priprema u rukometu ima sve značajniju ulogu. Vrhunska kondicijska priprema je temelj na kojemu se može graditi specifični proces sportskog treninga. Ritam i brzina ne mogu utjecati na rezultat, već su usko povezani sa fizičkom, tehničkom, taktičkom, teorijskom i psihičkom pripremljenošću. Da bi neka ekipa mogla igrati u različitom ritmu i pri tom mijenjati tempo s određenim taktičkim zadacima igrači moraju imati sposobnosti kao što su: brzina, izdržljivost, snaga i uspješnost u rješavanju tehničko- taktičkih elemenata u cjelini (Marković i sur., 2003). Izdržljivost možemo definirati kao kondicijsku sposobnost organizma da rad određenog intenziteta održava što duže vrijeme bez smanjenja efikasnosti. Posljednjih godina naglašava se važnost razvoja izdržljivosti kod sportaša neovisno o potrebama sportske specijalizacije iz razloga jer povoljno djeluje na efektivnost treninga, omogućava realizaciju intenzivnijeg trenažnog procesa i preduvjet je za efikasno korištenje ekstenzivne ili intenzivne intervalne metode, a to se

posebno odnosi na ponavljajuću metodu. Kako kontinuirani progresivni testovi ne sadrže odmor, mnogi smatraju da bi se Yo-Yo test morao češće provoditi jer je sličniji samom sportu. Ovaj test se primjenjuje kao terenska procjena igračevih sposobnosti da izvodi visoko intenzivne ponavljajuće vježbe (Bangsbo i sur., 2008) u timskim sportovima. Postoje različite vrste Yo-Yo testa, a u ovom radu su se koristili Yo-Yo 1 i Yo-Yo 2 Intermittent Recovery test (Yo-Yo IR1; Yo-Yo IR2). Mnogi terenski testovi su se razvili da bi procjenjivali kapacitete sportaša. Yo-Yo test se jako brzo razvio kao jedan od najistraživanijih „shuttle run“ testova u sportskoj znanosti zbog njegove specifičnosti i praktičnosti (Krustup i sur., 2003). Ovaj test se isto tako primjenjivao kao procjena igračevih sposobnosti da izvodi visoko intenzivne ponavljajuće vježbe (Bangsbo i sur., 2008) u timskim sportovima. Brzina, izdržljivost, snaga i uspješnost u rješavanju tehničko- taktičkih elemenata u cjelini (Marković i sur., 2003) su relevantni faktori za uspješnost jedne ekipe. Postoji dovoljna povezanost rezultata Yo Yo testa s drugim potencijalnim testovima koji opisuju igračku uspješnosti, ali ne i dovoljnu korelaciju u odabiru igrača na osnovu rezultata Yo-Yo IR1 testa kod reprezentativaca 17-godišnjaka (Hermassi i sur., 2015). Longitudinalna studija Matthys-a i sur., 2013. u dvije grupe (15/17god. i 13/15 god.) je pratila trogodišnji period promjena kod igrača te ih kasnije uspoređivala. Naposljetku, Yo-Yo izvedba i koordinacija sa i bez lopte su faktori koji najviše diskriminiraju u kvaliteti igrača. Ovi autori smatraju da su upravo te vještine potrebne da bi mladim trenerima i skautima dali smjernice za identifikaciju mladih talenta u rukometu. Yo-Yo IR1 test može smatrati timskim testom čiji su rezultati relevantni u procjeni isprekidanog visokog intenziteta izdržljivosti u muškom rukometu (Souhail i sur. 2010). Fiziološki profil igračica tijekom utakmica pokazuje da su igračice provele više od 83% vremena igre u zoni visokog intenziteta (frekvencija srca veća od 85% od maksimalne). Zadržavanje visokog intenziteta igre tijekom utakmice najviše ovisi o sposobnosti obnavljanja energetskih izvora tijekom perioda niskointenzivnih aktivnosti. Autori stoga preporučuju rad na unapređenju i anaerobne i aerobne snage tijekom treninga (Belka i sur., 2014).

Cilj ovog rada bio je utvrditi razlike u funkcionalnim sposobnostima među rukometašima različite kvalitete i dobi.

METODE RADA

Uzorak ispitanika su sačinjavale 4 rukometne ekipe različite dobi i različite uspješnosti. Kao prvoplasirana ekipa na rang ljestvici po uspješnosti u RH, RK

Zagreb (Grupa 1), brojila je 19 ispitanika; lošije plasirana ekipa RK Split (Grupa 2) brojila je 25 ispitanika; članovi juniorske reprezentativne vrste (Grupa 3) brojili su 21 ispitanika i prvoplasirana ekipa Kine (Grupa 4) brojila je 13 ispitanika. Ukupan broj ispitanika bio je 78. Ispitanici su testirani u obje verzije Yo-Yo IR testa u istom periodu u razmaku od 5 dana, osim ekipe prvligaša iz Kine koji zbog preklapanja energetske izvora rukometnog treninga nisu odradili L2 razinu.

Yo-Yo IR test je standardizirani fitness test s kojim se može odrediti „fitness level“, stupanj pripremljenosti funkcionalnih sposobnosti za timske sportove kojima odgovara isprekidano opterećenje igre. Izvodi se u kombinaciji kratkih intenzivnih trčanja sa kratkim periodima odmora. Kod Yo-Yo Intermittent Recovery testa razlikujemo dva stupnja: Level 1 i Level 2. Kod izvođenja oba Levela ne postoji razlika, jedino što Level 2 započinje pri brzini od 13 km/h dok Level 1 započinje pri brzini od 10 km/h. Oba stupnja rade progresiju u brzini kako test odmiče.

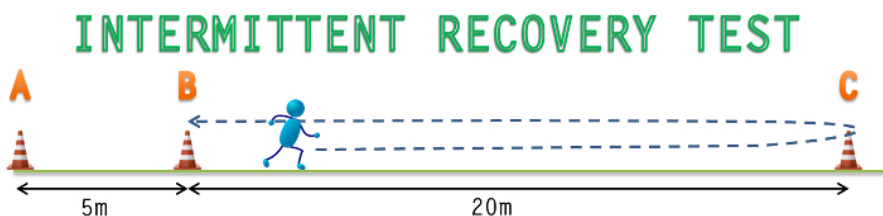

Slika 1. Yo-Yo Intermittent Recovery test

Opis testa: ispitanik se nalazi na oznaci „B“; sa zvučnim signalom započinje trčanje do sljedeće oznake (20 m – oznaka „C“); nakon dohvata oznake („C“) a sa zvučnim signalom okreće se i vraća do startne pozicije (oznake „B“) prije sljedećeg zvučnog signala. Nakon što je izvršio zadatak unutar vremena zvučnoga signala aktivni period oporavka započinje narednih 10 s (šetnjom ili laganim trčanjem do oznake „A“ i vraća se na startnu poziciju, tj. oznaku „B“), čekajući zvučni signal za sljedećih 2x20 m. Uz svaki zvučni signal pri početku nove dionice (svaki put kad je ispitanik na oznaci „B“) nakon zvučnog signala se očitava Level pri kojemu se trči. U slučaju kada ispitanik ne uspije doći do startne pozicije (oznake „B“) unutar vremena zadanog zvučnim signalom dobiva upozorenje od mjeritelja. Sljedeći put kad to ponovi označava se kraj testa, a rezultat je Level do kojega je uspio doći.

U prvom koraku izračunata je deskriptivna statistika; aritmetičke sredine, standardna devijacija, minimalan i maksimalan rezultat za svaku grupu u oba

testa pojedinačno. Nakon toga se analizom MANOVA sa Post hoc Tukey testom utvrdilo postoje li razlike među grupama ispitanika za Level 1 test i odvojeno za Level 2 test po svakoj grupi, sa postavljenom statističkom značajnosti $p < 0,05$. Za sve analize korišten je paket Statistica 12.0.

REZULTATI I RASPRAVA

U Tablici 1 prikazana je deskriptivna statistika Yo-Yo IR Level 1 te MANOVA sa Post hoc Tukey testom. Prema koeficijentu značajnosti ($p > 0,05$) razlike među grupama nisu statistički značajne. Level 1 test predstavlja sposobnost oporavka od ponavljajuće vježbe dok se aerobni energetski sustav testira do maksimuma, dok Level 2 mjeri sposobnost oporavka organizma od ponavljajuće vježbe dok se anaerobni sustav testira do maksimuma. Međutim, iz Tablice 2 možemo vidjeti da prema koeficijentu značajnosti ($p > 0,05$) ne postoje statistički značajne razlike među grupama ni u Level 2 izvedbi testa.

Tablica 1. Yo-Yo IRL1; Deskriptivna statistika, MANOVA.

	N	AS±SD	MIN	MAX	MANOVA (p)
GRUPA 1	19	1579,0±374,4	880	2160	0,09
GRUPA 2	25	1395,2±370,3	760	2200	
GRUPA 3	21	1375,2±391,2	840	2120	
GRUPA 4	13	1633,9±310,2	1120	2320	

Tablica 2. Yo-Yo IRL2; Deskriptivna statistika, MANOVA

	N	AS±SD	MIN	MAX	MANOVA (p)
GRUPA 1	19	591,6±148,8	400	840	0,15
GRUPA 2	25	492,8±189,0	240	1080	
GRUPA 3	19	517,9±157,5	240	880	

Prema dobivenim rezultatima, na osnovu pretrčanih metara iz Grafa 1 možemo vidjeti da bez obzira što razlike nisu statistički značajne među grupama možemo ih uočiti. Aritmetičke sredine rezultata pretrčanih metara Grupa 4 (Kineski prvoligaš) pokazuju nešto bolje rezultate u izvedbi testa Level 1 u odnosu na Hrvatskog prvoligaša, dok su Grupa 2 i 3 podjednake. Isto tako prema rezultatima u Level 2 izvedbi testa između tri grupe vidimo Hrvatskog prvoligaša u bolje rangiranom položaju u odnosu na ostale dvije grupe, što se može vidjeti iz Grafa 2. Razlog tome je što su ekipe Zagreba,

Splita i ekipa juniorske reprezentativne vrste bile na početku pripremnog perioda za nadolazeću sezonu, te su imale vremena za napredak, dok je ekipa kineskog prvligaša već bila u sustavu priprema za Kineske narodne igre koje su u rangu OI i održavaju se svake 4 godine. Zanimljiva je sličnost podataka Hrvatskih igrača na početku pripremnog perioda i Kineskih igrača koji su u prednatjecateljskoj sezoni. Da li rezultati Yo-Yo testa mogu potvrditi uspješnost ekipe i koliko se ustvari lošija fizička priprema može prepokriti nekim drugim dijelovima igre ostaje otvoreno pitanje. Kineski prvligaši su osvojili zlato na Kineskim narodnim igrama. Zanimljivi su rezultati mlade ekipe juniorske reprezentativne vrste koje ne čine razliku sa vrhunskim seniorskim klubovima, što potvrđuje dobru selekciju u kondicijskom dijelu, tehničko-taktičku uigranost, a to su i potkrijepili rezultatom (srebro na SP).

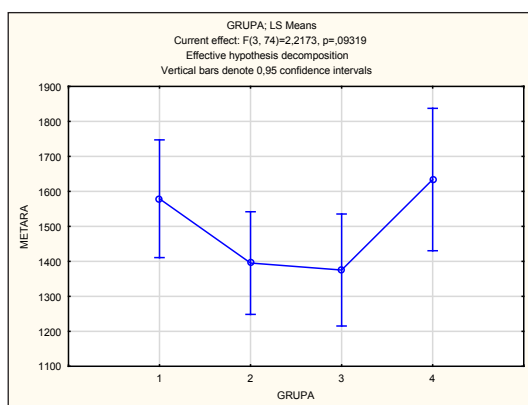

Graf 1. Rezultati u testu Yo-Yo IRL1 po grupama(1. RK Zagreb, 2. RK Split, 3.Juniorska reprezentativna vrsta, 4. Ekipa Kine)

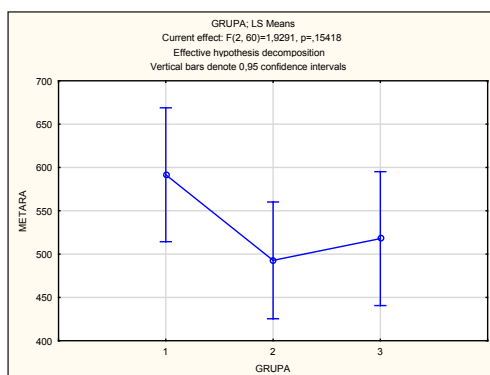

Graf 2. Rezultati u testu Yo-Yo IRL2 po grupama (1. RK Zagreb, 2. RK Split, 3.Juniorska reprezentativna vrsta, 4. Ekipa Kine)

INVITED LECTURES
POZVANA PREDAVANJA

ZAKLJUČAK

Procjena kapaciteta sportaša je jedno od glavnih pitanja u modernom sportu. Treneri i znanstvenici u sportu koriste razne terenske i laboratorijske testove za procjenu stanja sportaša, u selekciji ili za praćenje učinkovitosti režima rada. Za Yo-Yo test se smatra da je tip terenskog testa koji bi trebao zauzimati najvažniju ulogu u terenskoj dijagnostici ekipnih sportova. Razlozi takve tvrdnje leže u činjenici da je rukomet isprekidana igra koja se sastoji od intervala visokog intenziteta i intervala odmora. Prema normama koje po autoru testa prikazuju spremnost igrača ekipe su se kvalificirale u „dobro“ pripremljene sportaše (uz mogućnost od dva levela boljim rezultatima) što se objašnjava periodom priprema u kojem su se nalazili (početak pripremnog perioda) i za očekivati je da će vrijednosti u oba testa narasti. Autori su mišljenja da se seniorske ekipe na visokoj rukometnoj razini ne mogu diskriminirati prema rezultatima Yo-Yo testa, stoga se Yo-Yo test može smatrati test koji diskriminira mlade igrače po klubovima i služi kao jako dobar dijagnostički alat u selekciji mlađih ekipa, dok su seniorske ekipe i ekipe nacionalne vrste već prošle selekciju pa se ni rezultati u testovima ne razlikuju.

LITERATURA

Bangsbo J, Iaia M, Krstrup P. The Yo–Yo intermittent recovery test: A useful tool for evaluation of physical performance in intermittent sports. *Sports Med.* 2008;38:37–51.

Belka, J., Hulka, K., Safar, M., Weisser, R., & Samcova, A. (2014). Notacijska analiza i frekvencija srca vrhunskih rukometašica (U19) zabilježena tijekom natjecateljskih utakmica. *Kineziologija*, 46(1), 33-43.

Hermassi, S., Aouadi, R., Khalifa, R., Tillaar, R. V. D., Shephard, R. J., & Chelly, M. S. (2015). Relationships Between the Yo-Yo Intermittent Recovery Test and Anaerobic Performance Tests in Adolescent Handball Players. *Journal of Human Kinetics*, 45(1), 197-205.

Hermassi, S., Castagna, C., Yahmed, M. H., Younes, H., & Chamari, K. (2010). Direct Validity of the Yo-Yo Intermittent Recovery Test in Young Team Handball Players. *Journal of strength and conditioning research: the research journal of the NSCA*, 24(2), 265-270.

Krstrup P, Mohr M, Amstrup T, Rysgaard T, Johansen J, Steensberg A, Pedersen P, Bangsbo J. The Yo–Yo Intermittent Recovery Test: Physiological response, reliability and validity. *Med Sci Sport Exer.* 2003;35:697–705.

Marković, N., D. Vuleta, Z. Belančić (2003): Razvoj brzine u treningu rukometaša. U: Zbornik radova 12. ljetne škole kineziologa Republike Hrvatske, 157-159.

Matthys, S. P., Vaeyens, R., Franssen, J., Deprez, D., Pion, J., Vandendriessche, J., ... & Philippaerts, R. (2013). A longitudinal study of multidimensional performance characteristics related to physical capacities in youth handball. *Journal of sports sciences*, 31(3), 325-334.

Norkowski H. Anaerobic Power of Handball Players Representing Various Sport Levels. *Journal of Human Kinetics*. 2002;7:43–50.

Souhail, H., Castagna, C., Yahmed Mohamed, H., Younes, H., & Chamari, K. (2010). Direct validity of the yo-yo intermittent recovery test in young team handball players. *The Journal of Strength & Conditioning Research*, 24(2), 465-470.

SESSION PHYSICAL ACTIVITY FOR HEALTH
SEKCIJA KINEZIOLOŠKA AKTIVNOST ZA ZDRAVLJE



Keynote speaker

The protein supplements consumption among people attending commercial gyms: the Protein Project

Antonino Bianco

Sport and Exercise Sciences Research Unit, University of Palermo, Italy

Nowadays, in an European gym context we may find more than three people amongst ten who declare protein supplements consumption. Health, physical fitness, self-esteem, performance and muscle hypertrophy are usually the main reasons inducing such kind of consumption. It well documented that particularly active individuals use supplements to build muscle, gain strength or prevent future diseases and illnesses. Furthermore, scientific researchers have shown that in general people have different opinions about the use of supplements and the appropriate food to eat. As reported by Bianco and colleagues in 2011, proteins are the most widely ingested supplements in people attending commercial gyms and supplement users also consumed higher protein content foods in respect to those who did not supplement. It is clear that there is an increased interest in what is considered “proper” nutrition and what is the best nutritional strategy to optimize exercise-training workouts. Dietary behaviour is in fact a complex phenomenon; food-based approaches are regarded as the long-term strategy for improving nutrition.

These require significant efforts and appropriate planning in order to include certain specific macronutrients or supplements in every day’s diet. Moreover, the area of provenience seems to have an influence on supplements choices and on dietary behaviours (as reported by Bianco et al in 2014). Dieting or unhealthy eating practices, (such as eating foods deemed as “bad” by the dieter), in one-way or another, may be associated with long-term weight gain. Previous studies have shown discrepant rates of supplement intake amongst subjects that exercise in gyms. These different findings might be explained by different gyms and people enrolled. Probably an under or over-reported use of such supplements, or an incorrect knowledge of what is considered a supplement may lead to such results. As mentioned before, proteins are the most widely consumed supplement in commercial gyms, although association

of protein supplements and food consumption is a poorly researched field. It is to date unclear whether those more inclined to supplement also have healthier dietary patterns. As shown by Pechey and colleagues in 2010, socioeconomic status is another factor influencing the quality of food intake, highlighting that low socioeconomic status people usually purchase a greater proportion of unhealthy foods and beverages. Conversely, high socioeconomic status people purchase greater proportions of fibres, proteins and total sugars, and smaller proportions of sodium.

The protein project is a scientific project of ten years duration (2011-2021) led by the University of Palermo in collaboration with many partners from the entire world. It is composed by three different epidemiological studies: Study A) Population Target - Commercial Gym attendees, Study design, Face-to-face interview; Study B) Population Target - Commercial Gym attendees, Study design, Self Reporting Questionnaire; Study C) Population Target - Net Surfers Study design, Self Reporting Online Short Questionnaire. The protein project aims to investigate the use of protein supplementation, alone or in association with other supplements amongst regular fitness center attendees. The project is actually running in 4 European countries and involves 7 Universities. Moreover, Authors are interested in sources of information, dietary behaviour, quality of training and quality of life of people who are attending commercial gyms, The common questions we are trying to answer are: 1) Who is taking protein supplements nowadays? 2) There is enough information about? Within commercial gyms? Personal Trainers and Fitness Instructors are enough qualified to prescribe supplements? Are proteins really necessary to obtain results? Which kind of association is the most favourite in case of protein consumption?

In occasion of Contemporary Kinesiology 2015 the project will be detailed and new unpublished data concerning the comparison between people living in Italy vs United Kingdom will be reported and consequently discussed.

REFERENCES

2014. Protein supplements consumption: a comparative study between the city centre and the suburbs of Palermo, Italy. Bianco A, Mammina C, Thomas E, Ciulla F, Pupella U, Gagliardo F, Bellafore M, Battaglia G, Paoli A, Palma A. BMC Sports Sci Med Rehabil. 2014 Jul 12;6:29. doi: 10.1186/2052-1847-6-29. eCollection 2014.

2014. The use of protein supplementation among fitness center attendees. The protein project. Bianco A. EJSS Journal 2(1):61-63 - ISSN 2282-5673. Doi: 10.12863/ejssbx2x1-2014x4

2014. Protein supplementation and dietary behaviours of resistance trained men and women attending commercial gyms: a comparative study between the city centre and the suburbs of Palermo, Italy. Bianco A, Mammina C, Thomas E, Bellafore M, Battaglia G, Moro T, Paoli A and Palma A. J Int Soc Sports Nutr. 2014, 11:30 doi:10.1186/1550-2783-11-30

2011. Protein supplementation in strength and conditioning adepts: knowledge, dietary behavior and practice in Palermo, Italy. Bianco A, Mammina C, Paoli A, Bellafore M, Battaglia G, Caramazza G, Palma A, Jemni M. J Int Soc Sports Nutr. 2011 Dec 29;8(1):25. doi: 10.1186/1550-2783-8-25.

Keynote speaker

Organism adaptations on high altitude training

Lovro Štefan¹, Goran Sporiš¹, Dražen Čular², Damir Jurko²

¹Faculty of Kinesiology, University of Zagreb

²Faculty of Kinesiology, University of Split

ABSTRACT

Training in hypoxia conditions (relative decrease of oxygen in the air) is one of the most common ways for improving athletes conditioning before the competitions. Because of high altitude (around 2500 m), atmospheric pressure drops from 760 mmHg (sea-level) to around 550 mmHg. It means that in equal amount of air, quantity of oxygen is lower. In that way, lower amount of oxygen will come to skeletal muscle. Based on that, there are several physiological organism adaptations, where human body needs to be well-prepared (for example, iron concentration in blood and health conditions need to be tracked all the time). Effects of high altitude training, with proper duration and on optimal high were determined by tracking positive changes in functional and biochemical factors. Staying at high altitude gives athletes adaptations that he/she will expect on the competition. Well-prepared and organised training should be implemented to achieve morphological, motor and functional changes, which are the basic factors of every sports discipline.

Key words: physiological changes, acclimatization, hypoxia

INTRODUCTION

Altitude training is frequently used by competitive athletes to improve sea-level performance (Dick, 1992). On that altitude (2000-2500 m), chronically reduced inspiratory partial pressure of oxygen (PO₂) invoked a series of central and peripheral adaptations that served to maintain adequate tissue oxygenation in healthy skeletal muscle (Bert, 1943). The importance of oxygen transport and consumption in the body for endurance performance is the reason why altitude training, as preparation for competitions at sea level, has become popular. On ascent to altitude, acclimatization to hypoxia is reflected by

progressive increases in ventilation, adaptations in the cardiovascular system that enhance oxygen delivery to tissues, and alterations at the tissue level that allow for better extraction of oxygen and more oxygen effectiveness for metabolic processes (Bisgard, Neubauer, 1995; Weil, 1986). Also, environmental hypoxia initiates a series of metabolic, muscle and cardiorespiratory adaptations that influence oxygen transport and utilisation (Bailey, Davies, 2001). In hypoxia, maximal O_2 uptake decreases. Thus, for equal work load training at altitude is harder and stimulates adaptation processes more than sea level training. A specific altitude training effect, however, can only be proven if a relative equal load (in % of VO_{2max}) is more effective than during sea level training (Böning, 1997). Acclimatization to high altitude results in central and peripheral adaptations that improve oxygen delivery and utilization (Banchero, 1975; Brooks et al., 1992; Mairbaurl et al., 1986; Ou, Tenney, 1970). Hypoxic exercise may increase the training stimulus, thus magnifying the effects of endurance training (Bigard et al., 1991; Terrados et al, 1985). A series of single physiological changes at altitude might have positive or negative implications on training success: training of respiratory muscles, increase of hypoxic ventilatory stimulation, reduced heart training by vegetative "braking", increase of red cell and plasma volume (the latter after descent), right shift of the oxygen dissociation curve, increase of oxidative muscle enzymes (only after hypoxia training), shift from fat and muscle glycogen to blood glucose combustion, reduced lactic acid and ammonia production, increase in buffer capacity (Böning, 1997).

PHYSIOLOGICAL CHANGES ON HIGH ALTITUDE TRAINING

a) High altitude and blood changes

One of the most documented physiological adaptations to a reduced PO_2 is the increased release of erythropoietin, which causes a transient increase in red blood cell mass (Schmidt et al., 1993). Based on that, Weil et al. (1968) identified a biphasic relationship between the arterial partial pressure of oxygen (PO_2) and red blood cell mass, and shown a clear inflection point at a "critical" PO_2 of 67 mm Hg, equivalent to an interpolated arterial oxygen saturation of 92%. The equivalent PO_2 would equate to about 135 mm Hg, which is comparable with an altitude of 2200-2500 m above sea level required to stimulate sufficient haemopoiesis at rest to influence endurance performance (Levine, Stray-Gundersen, 1992). Nevertheless, Shepard et al. (1988) showed that the decrement in VO_{2max} measured in hypobaric hypoxia is directly

proportional to $VO_{2\max}$ in normoxia. Based on that, elite athletes are more prone to developing arterial hypoxaemia and may gain more benefit haematologically by training at lower altitudes (authors did not take plasma volumes). The normal erythropoietin reaction upon exposure to hypoxia comprises initially increased levels followed by a decrease after about 1 week. Thus, the maintenance of a high erythropoietin concentration is not a prerequisite for a sustained increase in erythrocyte formation at high altitude. The most important 'erythropoiesis-specific' nutrition factor is iron availability which can modulate erythropoiesis over a wide range in humans. Adequate iron stores are a necessity for haematological adaptation to hypoxia. However, at moderate altitude, there is a need for rapid mobilisation of iron and even if the stores are normal there is a risk that they cannot be mobilised fast enough for an optimal synthesis of haemoglobin. Data from healthy athletes training at moderate altitudes suggest a true increase in haemoglobin concentration of about 1% per week. Complete haematological adaptation occurred when sea level residents have similar haemoglobin concentrations at moderate altitude compared with residents. The normal difference in haemoglobin concentrations can be estimated to be about 12% between permanent residents at sea level and at 2500m above sea level (Berglund, 1992). It is well known that this type of polycythemia, due to anoxic stimulus brought about by the low atmospheric pressure, is reversible, or in other words, it disappears when the subject returns to a normal barometric pressure environment. It has also been found that there is a very close relationship between the degree of polycythemia and the level of altitude at which the permanent residents live, and that in newcomers the degree of response depends on the severity and the duration of the anoxic stimulus (Hurtado et al., 1945). All these factors offer an excellent opportunity for the study of production and destruction of the red blood cells along a physiologic pattern, since in the development of high altitude polycythemia and in the return of the blood values to normal there are no other influences beyond the anoxic one; this probably acts on erythrocytic activity through a hematopoietic factor (Stohlman, Brecher, 1956; Merino, 1956; Linmann, Bethell, 1957). Related to blood volume, hypoxia in itself increases iron demand and mobilisation (Rejnafarje et al., 1959; Hannon et al., 1969). Lack of this critical erythropoietic factor has been shown to inhibit complete haematological adaptation (Stray-Gundersen et al., 1993).

b) High altitude and free radical changes

Generation of reactive oxygen and nitrogen species (RONS) is a necessary consequence of aerobic metabolism. RONS are natural and

physiological modulators of cellular redox milieu and thereby signaling, controlling factors of a wide range of known and unknown physiological, pathophysiological processes. Despite of the multi line antioxidant system, the level of RONS generation can exceed the capability of defense network, leading to oxidative stress (Askew, 2002). Intensive muscular exercise results in the production of free radicals and reactive oxygen species (Jackson, 1994). Free radicals produced in skeletal muscle during hypoxia contribute to subsequent decreased force production (Mohanraj et al., 1998). Increased level of RONS production is not only due to the mitochondrial respiration, because anaerobic exercise also could cause oxidative damage (Radak et al., 1998). Similarly to anaerobic physical exercise exposure to high altitude often result in oxidative damage to macromolecules. Radak et al. (1997) showed that the level of protein oxidation, measured by carbonyl derivatives was increased after 4 weeks of continuous exposure to the altitude of 4000 m. At the study of Operation Everest III, the level of lipid peroxidation increased by 23% at 6000m, and by 79% at the altitude of 8848m indicating that the level of oxidative stress is parallel with the increase in altitude (Joanny et al., 2001). Also, Simon-Schnass (1994) identified significant increases in indirect indices of free radical mediated lipid peroxidation at altitude, which included increased pentane excretion and thiobarbituric acid reactive substances, decreased erythrocyte filterability, and increased leucocyte and granulocyte counts. An accelerated production of the highly toxic hydroxyl radical may occur as a consequence of an increased production of free iron derived from altitude induced and training induced destruction of red blood cells (Biselli et al., 1992). This type damage can be due to the increased level of ROS production and/or decreased level of antioxidant capacity.

c) *High altitude, immune and antioxidant status*

Changes in total leucocyte, granulocyte, monocyte, lymphocyte, natural killer cell, and T cell count, helper/suppression cell ratio, cell proliferation in response to mitogens, and serum immunoglobulin levels have all been implicated in some form of immunosuppression, which may subsequently cause underperformance in the athlete at sea level (Shepard, Pang, 1994). Human studies have shown that chronic exposure to hypobaric hypoxia results in a suppression of cell mediated immunity, whereas B cell function remains unimpaired (Meehan, 1987). Also, aerobic cells developed enzymatic and nonenzymatic antioxidant system to regulate the effects of RONS. Radak

PHYSICAL ACTIVITY FOR HEALTH
KINEZIOLŠKA AKTIVNOST ZA ZDRAVLJE

et al. (1994) and Nakanishi et al. (1995) presented decreased activity and protein content of mitochondrial SOD in skeletal muscle of rats. High altitude exposure decreases the level of reduced glutathione (GSH) and increase oxidized glutathione concentration (Ilvazhagan et al., 2001, Joanny et al., 2001). the capacity of enzymatic and non-enzymatic antioxidant systems is somewhat decreasing at high altitude. Schmidt et al. (2002) showed that adequate supplementation can prevent the high altitude associated oxidative damage. They have applied an antioxidant mixture containing vitamin E, beta-carotene, ascorbic acid, selenium, alpha-lipoic acid, N-acetyl-L-cysteine, catechin, lutein, and lycopene to reduce oxidative stress caused by altitude. This mixture was effective and the level of oxidative damage was reduced.

It appears that exposure to high altitude decrease the activity and content of some antioxidant enzymes. Moreover, the effectiveness of thiol system is also reduced by high altitude. There are some indications that antioxidant supplementation reduces or prevents the high altitude induced oxidative damage to macromolecules (Bakonyi, Radak, 2004).

d) High altitude and skeletal muscle changes

The first report on adaptations of muscle tissue to hypoxia, notably in humans, is the paper of Reynafarje (Reynafarje, 1962), who found oxidative capacity and myoglobin concentration to be elevated in biopsies of sartorius muscle from permanent high-altitude (4400 m). Hoppeler et al. (1990) showed loss in body mass (5-10%) and loss in muscle volume during acute hypoxia conditions. Reductions of 25 and 26 % for type II and type I fibres were reported for Operation Everest II (MacDougall et al., 1991). Capillary density increased by 9–12 % in human biopsy studies (Green et al., 1989; Hoppeler et al., 1990; MacDougall et al., 1991). The capillary-to-fibre ratio remains unchanged, arguing against capillary neoformation in humans exposed to hypoxia. Hoppeler et al. (1990) also found a decrease in the volume density of mitochondria of close to 20 %. Based on that, we can conclude that reductions in muscle volume and the reduction in oxidative capacity of muscle fibres exist. Martinelli et al. (1990) found an increase in lipofuscin levels after exposure to high altitude. Lipofuscin is a degradation product formed by peroxidation of lipid and is indicative of muscle fibre damage. The same study also found evidence for muscle regeneration: the volume density of

satellite cells, but not of myonuclei, increased significantly upon return from the expedition (Hoppeler, Vogt, 2001).

CONCLUSION

To sum it up, opinions are very controversial concerning the methods and effects of altitude training. Even well-trained and altitude-experienced athletes are not protected against negative effects of the acclimatization phase at altitude, although the effects last only a short time. While special preparations prior to the departure are not absolutely necessary, some precautionary measures are still advisable. Athletes should be in a welltrained state, particularly as far as endurance capacities are concerned, before leaving to altitude (IAAF, 2003). Future research should focus on methodological technicalities that optimise the balance between the favourable and less favourable responses to hypoxia and potential mediators of performance after return to sea level. Preliminary evidence showing that the additive stress of hypobaric hypoxia may provoke an adverse immune response and further potentiate free radical mediated oxidative injury has important implications which, if confirmed by scientific rigor, would present a threat to both the fitness and health of the elite competitor (Baley, Davies, 1997)

REFERENCES

- Askew, E.W. (2002). Work at high altitude and oxidative stress: antioxidant nutrients. *Toxicology*, 180, 107-119.
- Bailey, D.M., Davies, B. (2001). Physiological implications of altitude training for endurance performance at sea level: a review. *Br J Sports Med.*, 31, 183-190.
- Bakonyi, T., Radak, Z. (2004). High altitude and free radicals. *Journal of Sports Science and Medicine*, 3, 64-69.
- Banchero, N. (1975). Capillary density of skeletal muscle in dogs exposed to simulated altitude. *Proc. Soc. Exp. Biol. Med.*, 148, 435-439.
- Berglund, B. (1992). High-Altitude Training. *Sports Medicine*, 14 (5), 289-303.
- Bert, P. (1943). Barometric pressure: researches in experimental physiology. Columbus, OH: College Book Co, 1943. (Translated by MA Hitchcock and RA Hitchcock).
- Bigard, A. X., Brunet, A., Guezennec, C. Y., Monod, H. (1991). Skeletal muscle changes after endurance training at high altitude. *J. Appl. Physiol.*, 71, 2114-2121.
- Biselli, R., Pecci, G., Oliva, C., Fattorossi, A., D'Amelio, R., Barsotti, P. (1992). Effects of hypobaric hypoxia (HH) on polymorphonuclear granulocytes (PMNL) respiratory activity in HH-acclimatized and non-acclimatized rats [abstract]. *Int JSports Med.*, 13, 94.

Bisgard, G.E., Neubauer, J.A. (1995). Peripheral and central effects of hypoxia on the control of ventilation. In: *Regulation of Breathing*, (2nd ed.), edited by Dempsey, J.A. and Pack, A. New York: Marcel Dekker, 617–668.

Böning, D. (1997). Altitude and hypoxia training--a short review. *Int J Sports Med.*, 18 (8), 565-570.

Brooks, G.A., Wolfel, E.E., Groves, B.M., Bender, P.R., Butterfield, G.E., Cymerman, A., Mazzeo, R. S., Sutton, J. R., Wolfe, R. R., Reeves, J. T. (1992). Muscle accounts for glucose disposal but not blood lactate appearance during exercise after acclimatization to 4,300 m. *J. Appl. Physiol.*, 72, 2435–2445.

Dick, F. W. (1992). Training at altitude in practice. *Int. J. Sports Med.*, 13 (1), 203–206.

Green, H. J., Sutton, J. R., Cymerman, A., Young, P. M. and Houston, C. S. (1989). Operation Everest II: Adaptations in human skeletal muscle. *J. Appl. Physiol.*, 66, 2454–2461.

Hannon, J.P., Shields, J.L., Harris, C.W. (1969). Effects of altitude acclimatization on blood composition of women. *Appl Physiol.*, 26, 540-547.

Hoppeler, H., Kleinert, E., Schlegel, C., Claassen, H., Howald, H. and Cerretelli, P. (1990). Muscular exercise at high altitude. II. Morphological adaptation of skeletal muscle to chronic hypoxia. *Int. J. Sports Med.*, 11, 3–9.

Hoppeler, H., Vogt, M. (2001). Muscle tissue adaptations to hypoxia. *The Journal of Experimental Biology*, 204, 3133-3139.

Hurtado, A., Merino, C. and Delgado, F. (1945). Influence of anoxemia on the hematopoietic activity. *Arch. mt. Med.*, 75, 284.

IAAF Letter for CECS Level II Coaches (2003). Training at altitude.

Ilavazhagan, G., Bansal, A., Prasad, D., Thomas, P., Sharma, S., K., Kain, A.K., Kumar, D. and Selvamurthy, W. (2001). Effect of vitamin E supplementation on hypoxia-induced oxidative damage in male albino rats. *Aviation Space Environ Medicine*, 72, 899-903.

Jackson, M. (1994). Exercise and oxygen radical production by muscle. In: Sen, C.K., Packer, L., Hanninen, O. (Eds.), *Exercise and Oxygen Toxicity*. Elsevier, New York, pp. 49-57.

Joanny, P., Steinberg, J., Robach, P., Richalet, J.P., Gortan, C., Gardette, B. and Jammes, Y. (2001). Operation Everest III (Comex'97): the effect of simulated severe hypobaric hypoxia on lipid peroxidation and antioxidant defence systems in human blood at rest and after maximal exercise. *Resuscitation*, 49, 307-314.

Levine, B.D., Stray-Gundersen, J. A. (1992). practical approach to altitude training: where to live and train for optimal performance enhancement. *Int J Sports Med.*, 13, 209-212.

Linmann, J. 'IV. and Betcthell, F. H. (1957). The plasma erythropoietic stimulating factor in man. *J. Lab. & Clin. Med.*, 49, 113.

MacDougall, J. D., Green, H. J., Sutton, J. R., Coates, G., Cymerman, A. Y. P. and Houston, C. S. (1991). Operation Everest-II: Structural adaptations in skeletal muscle in response to extreme simulated altitude. *Acta Physiol. Scand.*, 142, 421–427.

Mairbaurl, H., Schobersberger, W., Humpeler, E., Hasibeder, W., Fischer, W., Raas, E. (1986). Beneficial effects of exercising at moderate altitude on red cell oxygen transport and on exercise performance. *Pflügers Arch.*, 406, 594–599.

Meehan, R.T. (1987). Immune suppression at high altitude. *Ann Emerg Med.*, 16, 974-979.

Merino, C. (1956). The plasma erythropoietic factor in the polycythemia of high altitudes. School of Aviation Medicine, USAF, Report No. 56-103.

Mobanraj, P., Merola, J., Wright, V., Clanton, T., (1998). Antioxidants protect rat diaphragmatic muscle function under hypoxic conditions. *Am. J. Physiol.* 84, 1960/1966.

Nakanishi, K., Tajima, F., Nakamura, A., Yagura, S., Ookawara, T., Yamashita, H., Suzuki, K., Taniguchi, N. and Ohno, H. (1995) Antioxidant system in hypobaric-hypoxia. *Journal of Physiology*, 489, 869-876.

Ou, L. C., Tenney, S. M. (1970). Properties of mitochondria from hearts of cattle acclimatized to high altitude. *Respir. Physiol.*, 8, 151–159.

Radak, Z., Asano, K., Lee, K.C., Ohno, H., Nakamura, A., Nakamoto, H. and Goto, S. (1997). High altitude training increases reactive carbonyl derivatives but not lipid peroxidation in skeletal muscle of rats. *Free Radical Biology and Medicine*, 22, 1109-1114.

Radak, Z., Lee, K., Choi, W., Sunoo, S., Kizaki, T., Oh-ishi, S., Suzuki, K., Taniguchi, N., Ohno, H. and Asano, K. (1994). Oxidative stress induced by intermittent exposure at a simulated altitude of 4000 m decreases mitochondrial superoxide dismutase content in soleus muscle of rats. *European Journal of Applied Physiology*, 69, 392- 395.

Radak, Z., Nakamura, A., Nakamoto, H., Asano, K., Ohno, H. and Goto, S. (1998). A period of anaerobic exercise increases the accumulation of reactive carbonyl derivatives in the lungs of rats. *Pflügers Archiv European Journal of Physiology*, 435, 439-441.

Rejnafarje, C., Lozano, R., Valdivieso, J. (1959). The polycythemia of high altitudes: iron metabolism and related aspects. *Blood*, 14, 433-455.

Schmidt, W., Spielvogel, H., Eckardt, K.U., Quintela, A., Penaloza, R. (1993). Effects of chronic hypoxia and exercise on plasma erythropoietin in high-altitude residents. *J Appl Physiol.*,74, 1874-1878.

Shephard, R.J., Bouhler, E., Vandewalle, H., Monod, H. (1988). Peak oxygen intake and hypoxia. *Int J Sports Med.*,9, 279-83.

Shephard, R.J., Pang, N.S. (1994). Potential impact of physical activity and sport on the immune system: a brief review. *Brit J Sports Med.*, 28, 247-255.

Simon-Schnass, I. (1994). Risk of oxidative stress during exercise at high altitude. In: Sen CK, Packer L, Hanninen O, eds. Exercise and oxygen toxicity. Amsterdam: Elsevier, 1, 191-210.

Stohlman, F., Jr. and Brecher, C. (1956). The erythropoietic response to hypoxia. Abstract from program of VI International Congress of the Society of Hematology.

Stray-Gundersen, A.C., Hochstein, A., deLomos, D., Levine, B.D. (1992). Failure of red cell volume to increase to altitude exposure in iron deficient runners. *Med Sci Sports Exerc.*,24, 90.

Terrados, N., Mizuno, M., Andersen, H. (1985). Reduction in maximal oxygen uptake at low altitudes; role of training status and lung function. *Clin. Physiol.*,5 (3);: 75-79.

Weil, J.V. (1986). Ventilatory control at high altitude. In: *Handbook of Physiology. The Respiratory System. Control of Breathing*, edited by Fishman, A.P., Cherniack, N.S., Widdicombe, J.G. and Geiger, S.R. Baltimore, MD: Williams and Wilkins, 2, p. 703-727.

Weil, J.V., Jamieson, G., Brown, D.W., Grover, R.F. (1968). The red cell mass-arterial oxygen relationship in normal man. *Clin Invest.*,47, 1627-1639.

Wolski, L.A., McKenzie, D.C., Wenger, H.A. (1996). Altitude training for improvements in sea level performance. Is the scientific evidence of benefit? *Sports Med.*, 22 (4), 251-263.

Representation of postural disorders of the lower extremities with students of classroom teaching with regard to the gender

Elvira Nikšić¹, Indira Mahmutović¹, Faris Rašidagić²

¹Faculty of Teacher Education, Sarajevo, Bosnia and Herzegovina

²Faculty of Sports and Physical Education, Sarajevo, Bosnia and Herzegovina

ABSTRACT

In order to successfully treat any kind of postural disorder or physical deformity, the most important thing is their early discovery. With careful observation of the child in an upright position, we can determine if there are any signs that indicate the presence of the deformity. To check if the knees are touching or overlapping, or maybe they went too far back. The present asymmetries on the ankles could lead to an unequal height of shoulders and shoulder blades. When the irregularities are noticed, the child is sent to corrective gymnastics. Those are therapeutic exercises whose goal is re-establishment of an imbalance between musculoskeletal system. In that way the further progress of the occurrence of deformities should be prevented. The goal of this research is determining the representation of postural disorders of the lower extremities with students of classroom teaching with regard to the gender, and also establishing their changes after the program is conducted. The research was conducted on a sample of 1105 students, of which 563 are boys and 542 are girls, at the age of 5 to 12. This research program includes students from I to V grade in eleven elementary schools in Sarajevo. For the evaluation of leg deformity, the method of leg posture is used, by the criteria of Napoleon Wolanski from (1975). D – 7 leg posture (ODN) – Mark of leg posture. The analysis of postural disorders of the lower extremities with students of classroom teaching with regard to the gender is done with the use of descriptive statistics of Chi square test. With the use of descriptive statistics the numerical and percentage frequency of leg deformities is determined, and it is shown in a table. It is determined that in the initial measuring there are no statistically significant differences between the students that go to different classes in the representation and degree of some kinds of leg deformities (Chi

square testis not statistically significant). In the final measuring, determined are the significant differences between the students that go to different classes in the degree and representation of some kinds of legs deformities (Chi square test is statistically significant), on a level lower than 1%.

Key words: students, leg deformities, age.

INTRODUCTION

Disorders in posture with children, based on previous research and statistical data, are mostly caused by the weakness of the muscle area of the back, chest and abdomen. Also, the weakness of the musculature of the pelvic girdle and lower extremities could lead to secondary disorders in the upper parts (Dejanović, A., Fratrić, F. 2007).

With the analysis of the disorders of lower extremities with students in classroom teaching, there is a statement of very often changes of feet, while less frequently changes of legs („X“ legs, „O“ legs and saber legs). Timely diagnosis of those changes is a priority task in order to undertake suitable measures and removing eventual deformities.

Frequency and heaviness of the deformity require early discovery and early treatment. In the previous years, there has been an increase of interest in the study of postural disorders with school children and youth. First of all, it is a result of social endeavor to timely and with efficient means influence the more present postural disorders with the youth.

Bjeković and Bratovčić (2005) state that corrective gymnastics could be used as a preventive mean to prevent the disorders in the development of a child. „Corrective gymnastics covers the whole musculature, giving the priority to the one that is weakened the most. It has to represent the synthesis of all positive movement used to remove the existing deformities.“

Vlaškalčić, Ž., Božić-Krstić, V. (2005) have conducted a research on a sample of 131 adolescent students in Sombor. The results of the examining have showed that saber legs are a more often phenomenon, than the „X“ legs. Lighter examinees more frequently encounter the „O“ legs.

Jovović, V., Čanjak, R. (2011) have conducted a research on a sample of 315 examinees, of which 160 were boys and 155 were girls, of an average age of 13.6. The research program covered the students of 23 elementary schools from different socio-economic environments in Montenegro. The goal of the research was to determine the frequency and the structure of postural

disorders. The condition of the postular status was evaluated with 10 postular variables. The results have shown that the postular status is very neglected with a great number of examinees of both genders. It is determined that the highest number of examinees has a compromised status of the spinal column and the shoulder blades. High frequency was also shown with the disorders of the lower extremities of the „O“ leg and flat foot.

Bogdanović, Z., Marković, Ž. (2011) have conducted a research on a sample of 651 examinees from I to VIII grade, of which 341 were boys and 310 girls, who were in an elementary school Dragiša Luković-Španac, which was situated in a suburban area of the town Kragujevac. Determining the presence of deformities of lower extremities of „X“ and „O“ legs, was conducted with a modified method by Napoleon Wolanski. The results have shown that the „X“ leg disorder is much more present (7,53%) than the „O“ leg disorder (4,76%) in the examined population. The „X“ leg disorder, mostly present in the fifth (11,36%) and the first grade (10,59%), while it is least expressed with the students of sixth (3,57%) and second grade (4,17%). With „O“ legs, the deformity is mostly manifested in the eighth grade with 11,67%, and in the second, fifth and sixth grade it generally does not exist. The „X“ leg disorder, with men is mostly registered in the eighth grade (10,84%), while with girls it is in the fourth grade (17,39%) and in the first grade (14,89%), and the „O“ leg deformity is mostly expressed with the boys in eighth grade (19,28%), while with the girls the highest presence is evidenced in the third and the eighth grade with around 5%.

METHODS

The research was conducted on a sample of 1105 students, of which 563 are boys and 542 are girls, at the age of 5 to 12. This research program includes students from I to V grade in eleven elementary schools in Sarajevo: „Kovačići“, „Behaudin Selmanović“, „Sokolje“, „Dobroševići“, „Safet-beg Bašagić“, „Zahid Baručija“, „Fatima Gunić“, „Aleksa Šantić“, „Avdo Smailović“, „Mehmedalija Mak Dizdar“, „Hamdija Kreševljaković“.

In every school, students from I – V grade were tested, of which:

- I grades 221 students (113 boys + 108 girls),
- II grades 214 students (109 boys + 105 girls),
- III grades 218 students (107 boys + 111 girls),
- IV grades 237 students (121 boy + 116 girls),
- V grades 215 students (113 boys + 102 girls).

To determine the leg deformity, the following variable was used: Mark of legs posture – ODN (0 – Pose heeled normal: knees vertically straight or at least approximately; 1 – Pose heeled normal: knees tending to „X” shape and touching; 2 – Pose heeled: significant tending of the knees to „X” which is significant tending to „O” for higher thickness of 2 fingers of examinee).

Experimental procedure

Working program that was realised in this research lasted one school year of 2011/12. The working program is concipated in the following way: In the beginning of the school year in September, the initial (beginning measuring) of postular disorders of the lower extremities (legs) was conducted, with the method of legs posture, by the criteria of Napoleon Wolanski from (1975). D -7 legs posture (ODN) – Mark of legs posture, with the help of a teacher/professor of classroom teaching. The examinees excercised following the determined program intended to prevent and correct the postular disorders of the lower extremities (legs), which were made after the initial measuring. The concept of the program was made in such way that it is conducted through forms of applied activities in Physical and health culture of the students in classroom teaching. Every excercise started with physiologically and emotionally preparing the organism. Cardiovascular introduction of the functions of the load which were about to follow, represented a initial physiological load. Emotional introduction to this kind of special program had an exceptional importance. Each excercis was performed starting from the easiest and going to the most difficult part. To get the best effect, special attention was given to the following: concrete demonstration of the excercises, because it was about strictly defined moves. Because of that, after the demonstration and the explanation of the teacher, the students tried to do the certain task.

The explanations were short and regarded the way of performing and the goal of certain excercises with regarding the gender. The program content was not statical, because the excercises were performed in order to correct and prevent the present disorders, they changed and adapted to given situations, complemented each other, depending on the motivation of the students, because in time if certain excercises are daily repeated, the become monotoneous to the students and in that way the attention to the correct performing of the moves decreases. -After the initial (beginning) measuring, a 6 month (31 week) program was conducted. The program was realised in the period of (October, November, December, February, March, April, school year of 2011/12), in which teachers/

professors of classroom teaching were working. Number of training units: two times a week classes of Physical and health culture, where were applied the exercises in the function of preventing and correcting postular disorders of the lower extremities (legs).Duration of one class was: 45 minutes.At the end of the school year in May, the final measuring of postular disorders of lower extremities (legs) was conducted, with the method of legs posture, by the criteria of Napoleon Wolanski from (1975). D-7 legs posture (ODN) – Mark of legs posture, with the help of a teacher/professor of classroom teaching.In the program of 6 months duration were not included the testing and the measuring, so they were also conducted after the applied program. After finishing the initial and the final testing and measuring. there was an evaluation of the given results.

Table 1. Exercise program for correcting and preventing postular disorders of the lower extremities (legs)

	Starting position	Exercise description
CORRECTIVE EXERCISES FOR „X“ LEGS	Starting position lying on the back	1. In the starting position the ankle joints are one over the other, tightly connected. Separate the knees without bending them. Instead of fixating the ankle joints, an assistant can help.
		2. In the starting position lean one knee to the other. Then pull the ankle joints to one another, trying to put them together. The knees must stay outstretched.
		3. From the starting position intermittently lift one and then the other leg stretched in the knee. The foot is in pronation (toes turned outwards).
		4. In the starting position correct the knee and the lower leg position with a helping tool. By putting an object under the knees, and later in the ankle joint area, make the progressive leg lifting more difficult. During that, strongly tighten the abdominal musculature.
	Starting position lying on the hip	1. In the starting position correct the knee position. Lift the upper body part from the ground. Do the exercise on both left and right hip.
	Starting position sitting	1. In the starting position put pillows between the knees while simultaneously bringing closer the ankle joints by tightening.
		2. In the starting position put together the soles, and push down the knees using the palms.
		3. From the starting position try to stand up with legs crossed and get back to the sitting position.
	Starting position sitting with legs crossed	1. In the starting position push the knees to the ground using fists. Try standing up.
	Starting position crouching	1. In the starting position the feet are turned outwards, palms put together and push the knees aside using elbows.
2. Walk crouching with feet turned outwards.		

PHYSICAL ACTIVITY FOR HEALTH
KINEZIOLŠKA AKTIVNOST ZA ZDRAVLJE

	Starting position standing and walking	1.	In the starting position rely on the outer feet edges, separate the knees.
		2.	In the starting position walk on toes, and then on the outer edge of the feet.
		3.	Game: Race with tied legs (Tie the ankle joints with a rope and organise the race).

CORRECTIVE EXERCISES FOR „O“ LEGS	Starting position sitting with legs stretched	1.	From the starting position lift both legs from the ground at the same time. The feet are twisting sole to sole.
		2.	In the starting position fixate the ankle joints one to the other. Pull the knees toward each other.
		3.	In the starting position put a medicine ball between the ankle joints. Lift both legs at the same time from the ground, holding the medicine ball tightly, bringing the knees closer to each other.
	Starting position standing	1.	In the starting position require the students to bring the knees closer to each other with a strong pushing of the feet to the ground.
		2.	In the starting position walk with the load on the inner edge of the feet, the knee of the standing foot push inside.
		3.	Starting position, leg fixated to some object with a rope. Separate the leg aside intermittently overcoming the resistance. The knee must be stretched out while performing the move.
		4.	From a standing starting position walk on the corrective boards, podiums made in the shape of the letter „V“.
		5.	Game : The fastest reptile (The contestants sit on the floor turned and they put their hands behind their back, and they cross their legs and lift them. They race to the adjacent wall by moving backwards).
		6.	Game: Tied knees race. Children race with knees tied with a scarf or a rope and in that way they strengthen their lower leg muscles and inner thigh muscles.



CORRECTIVE EXERCISES FOR SABER LEGS	Applied were:	1.	Exercise for strenghtening the pelvic girdle muscles.
		2.	Excercise for strenghtening the-hamstring leg muscles, and stretching the front musculature.
		3.	Excercise for strenghtening the quads leg muscles.
		4.	Excercise for strengthening the flexor of lower legs and feetfor stabilization of leg support.

Statistical analysis

With the use of descriptive statistics, numerical and percentage frequency of leg deformities is determined, and they are shown in a table.

RESULTS

Table 2. A display of frequency distribution of some marks of leg posture in initial and final measuring, and regarding the grade

Body part	Class	Posture measuring				
		Grade (score)	Initial		Final	
			F	%	F	%
Legs	I	0	148	67,0	178	80,5
		1	40	18,1	25	11,3
		2	33	14,9	18	8,1
		Total	221	100,0	221	100,0
	II	0	165	77,1	194	90,7
		1	24	11,2	7	3,3
		2	25	11,7	13	6,1
		Total	214	100,0	214	100,0
	III	0	170	78,0	198	90,8
		1	27	12,4	11	5,0
		2	21	9,6	9	4,1
		Total	218	100,0	218	100,0
	IV	0	183	77,2	214	90,3
		1	36	15,2	19	8,0
		2	18	7,6	4	1,7
		Total	237	100,0	237	100,0
	V	0	172	80,0	189	87,9
		1	22	10,2	14	6,5
		2	21	9,8	12	5,6
		Total	215	100,0	215	100,0

From the following table 2. we can see that in the initial measuring the highest number is of students in IV grade that have no deviation with legs posture, while the biggest representation of slightly expressed deviation with leg posture have the students in I grade, in initial measuring this difference is statistically significant on a level lower than 5%, on which the Hi-square from the lat analysis indicates (Hi-square=16,168 and p=0,040).

And in the final measuring, and from what we can see in the upper table and graph, the biggest is the number of students in the IV grade that have no deviation with legs posture, and the highest representation of slight and expressed deviation of legs posture have the students in the I grade, and this time the difference is statistically significant on a level lower than 1%, (Hi-square=24,216 and p=0,002).

Table 3. The values and the degrees of significance of Hi-square in examining the differences of the students going to different grades in representation of some kinds of deformities of lower extremities (legs).

Initial			Final		
Hi-square	Degrees of freedom	Level of significance	Hi-square	Degrees of freedom	Level of significance
24,678	16	0,076	27,216	12	0,007 **

** Hi-square is statistically significant on a level lower than 1%

From the table 3. we can see that in the initial measuring there are no statistically significant differences between the students who go to different classes in representation and degree of some kinds of legs deformities (Hi-square is not statistically significant). In the final measuring there are determined some significant differences between the students that go to different classes on a degree and representation of some kinds of legs deformities (Hi-square is statistically significant), on a level lower than 1%.

Table 4. The display of frequency distribution of some kinds of legs deformities in initial and final measuring, regarding the class

Body part	Class	Posture measuring				
		Deformity	Initial		Final	
			F	%	F	%
Legs	I	O-legs	31	14,0	18	8,1
		Normal	148	67,0	178	80,5
		X-legs I degree	34	15,4	19	8,6
		X-legs II degree	2	0,9	6	2,7
		Saber legs	6	2,7	0	0,00
		Total	221	100,0	221	100,0
	II	O-legs	24	11,2	13	6,1
		Normal	165	77,1	194	90,7
		X-legs I degree	22	10,3	7	3,3
		X-legs II degree	1	0,5	0	0,00
		Saber legs	2	0,9	0	0,00
		Total	214	100,0	214	100,0
	III	O-legs	21	9,6	9	4,1
		Normal	170	78,0	198	90,8
		X-legs I degree	24	11,0	9	4,1
		X-legs II degree	0	0,00	2	0,9
		Saber legs	3	1,4	0	0,00
		Total	218	100,0	218	100,0
	IV	O-legs	18	7,6	4	1,7
		Normal	183	77,2	214	90,3
		X-legs I degree	31	13,1	14	5,9
		X-legs II degree	5	2,1	5	2,1
		Saber legs	0	0,00	0	0,00
		Total	237	100,0	237	100,0
	V	O-legs	21	9,8	12	5,6
		Normal	172	80,0	188	87,4
		X-legs I degree	15	7,0	9	4,2
X-legs II degree		0	0,00	6	2,8	
Saber legs		7	3,3	0	0,00	
Total		215	100,0	215	100,0	

As we can see in the table 4. the deformity types O-legs, X-legs of I degree and saber legs are with students that go into different classes much more represented in initial measuring, in regard to the final measuring, and X legs of II degree are much more represented with students in I, III and V class, in the final measuring in regard to the initial measuring, while the deformity type X-legs of II degree is equally present with students in IV class, and saber legs are not represented neither in the initial nor the final measuring with the students in the IV class, while in the final measuring normal legs are more represented.

DISCUSSION

With the mark of legs posture of students in I grade of elementary school, and regarding the type of deformity, it led to some information that shows that in the initial measuring 148 (67,0%) students c 34 (15,4%) students have X-legs of I degree, 2 (0,9%) students have X-legs of II degree, 31 (14,0%) student has O-legs, and 6 (2,7%) students have saber legs. In the final measuring, 178 (80,5%) students in the I grade have heeled normal pose: knees vertically straight or at least approximately, which indicates that there is no deviation. 19 (8,6%) students have X-legs of I degree, 6 (2,7%) students have X-legs of II degree, 18 (8,1%) students have O-legs, while saber legs in the final measuring were not represented with the students in the I grade.

165 (77,1%) students in the II grade have a heeled normal pose: knees vertically straight or at least approximately, which indicates that there is no deviation. 22 (10,3%) students have X-legs of I degree, 1 (0,5%) students have X-legs of II degree, 24 (11,2%) students have O-legs, and 2 (0,9%) students have saber legs. In the final measuring, 194 (90,7%) students in the II grade a heeled normal pose: knees vertically straight or at least approximately, which indicates that there is no deviation. 7 (3,3%) students have X-legs of I degree, 13 (6,1%) students have O-legs, while X-legs of II degree and saber legs in the final measuring were not represented with students in the II grade.

170 (78,0%) students in the III grade have a heeled normal pose: knees vertically straight or at least approximately, which indicates that there is no deviation. 24 (11,0%) students have X-legs of I degree, 21 (9,6%) students have O-legs, and 3 (1,4%) students have saber legs, while X-legs of II degree in the initial measuring were not represented with the students in the III grade. In the final measuring, 198 (90,8%) students in the III grade have a heeled normal pose: knees vertically straight or at least approximately, which indicates that

there is no deviation. 9 (4,1%) students have X-legs of I degree, 2 (0,9%) students have X-legs of II degree, 9 (4,1%) students have O-legs, while saber legs in the final measuring were not represented with students in III grade.

183 (77,2%) students in the IV grade have a heeled normal pose: knees vertically straight or at least approximately, which indicates that there is no deviation. 31 (13,1%) student has X-legs of the I degree, 5 (2,1%) students have X-legs of II degree, 18 (7,6%) students have O-legs, while saber legs in the initial measuring were not represented with the students in IV grade. In the final measuring, 214 (90,3%) students in the IV grade have a heeled normal pose: knees vertically straight or at least approximately, which indicates that there is no deviation. 14 (5,9%) students have X-legs of I degree, 5 (2,1%) students have X-legs of II degree, 4(1,7%) students have O-legs, while saber legs in the final measuring were not represented with students in IV grade.

172 (80,0%) students in the V grade have a heeled normal pose: knees vertically straight or at least approximately, which indicates that there is no deviation. 15 (7,0%) students have X-legs of I degree, 21 (9,8%) students have O-legs, and 7 (3,3%) students have saber legs, while X-legs of II degree in the initial measuring were not represented with the students in the V grade. In the final measuring, 188 (87,4%) students in the V grade have a heeled normal pose: knees vertically straight or at least approximately, which indicates that there is no deviation. 9 (4,2%) students have X-legs of I degree, 6 (2,8%) students have X-legs of II degree, 12 (5,6%) students have O-legs, while saber legs in the final measuring were not represented with students in V grade.

The given results of the research lead to a ascertainment that the disorders of the lower extremities (legs) are represented with students of classroom teaching in the city of Sarajevo. Many authors had similar results in their researches.

The disorder of the lower extremities of X leg is present mostly in IV and I grade, and least with the students of VI and II grade. In other classes the presence of this disorder is slightly smaller and pretty equaled. The deformity of the „O“ leg is mostly manifested in the VIII grade, and in the II, V and VI grade there is no deformity at all. Analysing the total number of examinees, the data show us that the „X“ leg disorder is two times more present than the „O“ leg disorder in the examined population (Bogdanović, Marković, 2011).

Ristić, V., and associates (2002), research the presence of osteoarticular deformities in the population of the students in the elementary schools in munic-

ipality of Bojnik. There were determined deformities on the lower extremities in 2,88% of the cases. The goal of the work was to determine the real state and based on the given results to take measures of primary prevention and early treatment. The given results vary within the limits of literature data, and in some other cases different results are achieved.

Vlaškalčić, Ž., and associates (2005), have shown that there is a connection between the physical height and the body mass with some deformities of the locomotor apparatus. Heavier examinees are characterised by „X“ legs, and lighter examinees more commonly encounter „O“ legs.

Đokić, Z., Stojanović, M. (2010), on a sample of 1.523 students, 775 boys and 748 girls, of school age from III to VI grade, (9 to 12 years) in the area of Sremska Mitrovica, assess the evaluation of the morphological and postural status. The authors conclude that leg deformities are represented in 1,9% of the cases, more with the girls than with the boys.

CONCLUSION

In this work there are obtained data about the state of postural disorders of the lower extremities (legs), as well as the data about how it can significantly be influenced on a change by applying the continued and planned corrective procedure, and lead to a decrease of deviation. It is necessary that, besides the pedagogue of Physical and health culture, there are maximally educated teachers in the lower grades of elementary schools, in order to recognize certain postural disorders and physical deformities with the population of students who they daily encounter in their work. Besides that, it is necessary to develop consciousness about a healthy way of living, which includes physical exercises, whether recreational or of competitive nature, which will preventively affect on a postural status of the examined population. It is obvious that the postural status with the students of classroom teaching is compromised. The existing situation imposes the need of a more considerably serious approach to this problem from all the responsible subjects. Only by working together and engagement of the parents, educational and medical workers, as well as everyone who works with children, we can stop further compromising of the postural status of young people and ease the negative affect of the „contemporary“ way of life. The existing problem did not appear „over night“, but it has been indicated over the years. It is certain that with every year the situation get more difficult, and if adequate and concrete measures are not

taken, we should not expect important changes in the positive sense. Most of the researches of this kind unfortunately stays anonymous to the public, or in the best case a smaller news paper article is dedicated to this problem. It is certain that, in solving this problem, the media should play a very important role. Because their affect on the public opinion is already known. Permanent warnings of the leading experts from the adequate areas via broadcasting means and press, with time can raise awareness among citizens about the need for a higher concern directed towards forming a regular body posture with children, since the earliest days.

LITERATURE

Bjeković, G., Bratovčić, V. (2005): *Corrective gymnastics for the preschoolers and classroom teaching, practical part*. East Sarajevo. Faculty of physical education, pg. 90 – 93.

Bogdanović, Z., Marković, Ž. (2011): *The presence of postular disorders of lower extremities with students of different gender and age*. Messenger ADS, 46 (1), pg. 383 - 390.

Dejanović, A., Fratrić, F. (2007): *Spinal column (not) training and children. Monograph*. Beograd: Faculty for sports management, University „Braća Karić“.

Đokić, Z., Stojanović, M. (2010). *Morphological characteristic and postular status of children from 9 to 12 years in the area of Sremska Mitrovica*. General Medicine, 16 (1-2), 41- 49. Beograd.

Jovović, V., Čanjak, R. (2011): *Frequency and structure of postular disorders with students of younger adolescent age in Montenegro*. Proceedings Book , 3 International Scientific Conference, Banja Luka, str. 33.

Koturović, Lj., Jeričević, D. (1970): *Corrective gymnastics*, Beograd.

Koturović, Lj., Jeričević, D. (1983): *Corrective gymnastics IV edition*. Sports book, Beograd.

Koturović, Lj., Jeričević, D. (1984): *Corrective gymnastics II updated and corrected edition*. The role of Physical Culture educationalist in the prevention of school youth deformities. Beograd.

Krsmanović, T. (2007): *Postular disorders and how to prevent them*. Messenger of Anthropological Society of Serbia, 42, pg. 345 - 351.

Ristić, V., Marković, V., Ljubić M. (2002): *Osteoarticular deformities with students in elementary schools in municipality of Bojnik*. Acta medica Medianae, 3, 63 – 67, Niš.

Vlaškalčić, Ž, Božić-Krstić, V. (2005). *Connection of hight and body mass with the physical deformities of adolescents in Sombor*, Messenger of Anthropological Society of Yugoslavia, no. 40 : 89-94, Novi Sad.

Wolansky, N. (1975). *Body growth and development with tracking the body posture*. Teachers' manual, Varšava.

Živković, D., Milenković, S., Drobnjak, D. (2004): *Condition of the postular disorders and physical deformities of younger school children in municipalities of Zaječar, Kruševac and Čačak*. Sport Mont, 2-3(2), 421-426.

The connection between body composition and fitness performance among elderly men

Saša Pantelić, Zoran Milanović, Radmila Kostić, Slavoljub Uzunović, Milovan Bratić, Saša Veličković, Tomislav Okičić, Nenad Stojiljković

University of Niš, Faculty of Sport and Physical Education, Serbia

ABSTRACT

The aim of this research was to determine the connection between the fitness performances and body composition of elderly men. In order to evaluate their fitness level, the Senior fitness battery of tests was used: 8-Foot Up-and-Go, Back Scratch, Chair Sit-and-Reach, 2-Minute Step Test, 30-Second Chair Stand and the Arm Curl. Body composition was evaluated using the Body Mass Index, Muscle mass [kg], Body fat [kg], Body fat [%] and Lean body mass [kg]. The sample of participants consisted of 59 elderly men between the ages of 65 and 70 (67.29 ± 1.58). To calculate the connection between body composition and fitness performance, the canonical correlation analysis was used. To calculate the connection between body composition and fitness performance, the canonical correlation analysis was used. The research results indicated that there is a statistically significant connection between body composition and fitness performance among elderly men. The space of body composition was best determined using the values of body fat and BMI, while the space of fitness performance was best defined using aerobic and muscle endurance and flexibility. Based on the obtained results, it was determined that among the elderly, health-related fitness components to a great extent depend on body composition, where the most important role is played by body fat and BMI. The reduction in the cited parameters could lead to an improvement in the fitness components among senior citizens.

Keywords: Elderly, fitness, BMI, body composition.

INTRODUCTION

The increase in the overall number of the elderly can be noted in almost all the countries in the world. Based on the data collected by the United Na-

tions (2005), an increase in the number of senior citizens by 2% was noted in the period between 1950 and 2000, which represents 10% of the overall population. However, based on the same data, it is assumed that by 2050, the number of the elderly who are over the age of 60 will make up as much as 22% of the overall population. In 2000, in the US and China almost 28% of the population was made up of citizens over 65, and it is expected that this number will rise to 33% in the following 20 years (He, Sengupta, Velkoff, & De-Barros, 2005). At the same time, in addition to the increase in the number of senior citizens, there is also an increase in the average age. Daley and Spinks (2000) determined that the average age of men and women in 1980 was 69.8 and 77.5, respectively, and that in 2040 it is expected that the average age will be as high as 75.0 for men and 83.1 for women. In order for senior citizens to be physically independent and to be able to care for themselves, they must possess a certain level of physical fitness (Rikli & Jones, 2001). Fitness in physical exercise and sport includes general physical ability and physical fitness, which is necessary for everyday and all other activities to be performed with the possibility of delaying the onset of fatigue. Functional fitness can also be defined as the physical capacity for performing everyday activities, independently and without the onset of fatigue, which includes the components such as muscle force, aerobic endurance, flexibility and agility/dynamic balance (Rikli & Jones, 2001).

A decrease in the level of physical activity and an inactive lifestyle, along with the aging process itself, lead to a decrease in muscle mass and strength. Between the ages of 30 and 80, muscle mass and strength decrease by 30% and 50% (Daley & Spinks, 2000). A decrease in these abilities is caused by the aging process, which leads to difficulties in the daily functioning of the elderly (Tuna, Edeer, Malkoc, & Aksakoglu, 2009). In order to maintain these abilities, physical activity has a very important role. Inadequate physical activity leads to a significant decrease in functions which are necessary for normal everyday life (Nagamatsu et al., 2003).

The aim of this research was to determine the connection between body composition and the fitness status of the elderly. It is assumed that increased weight among the elderly, that is, increased values of the parameters of body composition, will have a corresponding influence on the performance of

movement tasks which require strength, flexibility, endurance and agility (dynamic balance).

METHODS

Participants

A total of 69 randomly selected elderly men, with an average age of 67.2 ± 1.5 were included in the study. The average body height of the participants was 169.7 ± 5.5 cm, and body mass was 72.6 ± 6.2 kg. Each of the participants volunteered to participate in the study, and was able to withdraw at any point during the testing. Prior to the beginning of the testing, all of the participants were informed of the advantages and possible consequences of taking part in the study. The participants were mentally and physically able to participate. Any individuals who had cardiovascular problems were excluded from participation, due to the potential risks involved in physical fitness testing. The Ethics Committee of the Faculty of Sport and Physical Education, at the University of Nis verified that this investigation followed all the ethical standards regarding scientific investigations involving human subjects.

Measurements

The determination of the body composition was carried out by the bioelectrical impedance analysis, using a TANITA BC 540 InerScan Body Composition Monitor. The following parameters were evaluated: Body Fat in percentages (BF%), Body Fat in kilograms (BFkg), Muscle Mass in kilograms (MMkg). The Body Mass Index (BMI) was calculated using a standard procedure based on formulas where body mass is expressed in kg and divided by the square of the value of body height presented in m^2 (WHO, 1997). Lean body mass presented in kilograms (LBMkg) was calculated using the Medved formula (1987). In order for the obtained results of the evaluation of body composition to be as precise as possible, the measuring was carried out following the ACSM protocol (Heath, 2005).

To evaluate *fitness performance*, the battery of tests created by the authors Rikli and Jones (2001) was used, i.e. the Senior Fitness Test (SFT). The battery consists of six tests of measurement, meant for the testing of individuals between the ages of 60 and 90. In this study, the following tests were used: 8-Foot Up-and-Go (to evaluate agility/dynamic balance – expressed in seconds), Back Scratch (to evaluate shoulder flexibility - cm), Chair Sit-and-Reach (to evalu-

ate the mobility of the lower body - cm), 2-Minute Step Test (to evaluate aerobic and muscle endurance – the number of steps), 30-Second Chair Stand (to evaluate the strength of the lower body – the number of lifts) and the Arm Curl (to evaluate arm strength – the number of repetitions). Before performing the test, the participants first had to undergo a 10-minute warm-up, and then went on to perform the complete SFT.

The first to be measured were the parameters of body composition, followed by the testing of the parameters of cardiorespiratory fitness.

Statistical analysis

The basic descriptive statistics parameters (Mean – arithmetic means, SD – standard deviation) were calculated for all the studied parameters. In order to determine the connection between body composition and fitness performance, the canonical correlation analysis was used. The level of significance was defined as 0.05. The results were processed with the help of the statistical package STATISTICA 7.0 (StatSoft. Inc., Tulsa, OK, USA).

Results

Table 1. shows the basic descriptive statistics parameters (means and standard deviation), for all the applied variables for body composition and fitness performance. The interconnection between the space of body composition and fitness performance is shown in Table 2. as a cross-correlation matrix. The lowest value for the correlation, -.02, was noted between Body Fat [kg] and the 30-Second Chair Stand, as well as Lean Body Mass [kg] and the 2-Minute Step Test (.03). The highest values of the correlation were noted between the variables Body Fat [%] and Back Scratch (-.76), and Body Fat [kg] and Back Scratch (-.62).

Table 1. The basic descriptive statistics parameters (n=59; Mean±SD)

Body composition		Fitness performance	
Body mass index (kg/m ²)	25.22±1.69	8-Foot Up-and-Go (s)	4.93±0.66
Muscle mass (kg)	21.03±1.88	Back Scratch (cm)	-5.04±8.17
Body Fat (kg)	26.42±3.81	Chair Sit-and-Reach (cm)	5.73±8.66
Body Fat (%)	36.26±2.43	2-Minute Step Test (rep)	99.58±10.11
Lean body mass (kg)	46.17±3.02	30-Second Chair Stand (rep)	15.90±2.03
		Arm Curl (rep)	17.34±2.67

Table 2. The cross-correlation matrix for the parameters of body composition and fitness performance

	BMI	MM	BF	BF%	LBM
8-Foot Up-and-Go (s)	.12	-.09	.06	.20	-.22
Back Scratch (cm)	-.55	-.17	-.62	-.76	-.10
Chair Sit-and-Reach (cm)	-.55	-.14	-.38	-.54	.04
2-Minute Step Test (rep)	-.54	-.16	-.41	-.58	.03
30-Second Chair Stand (rep)	-.20	.15	-.02	-.11	.15
Arm Curl (rep)	.12	-.09	.06	.20	-.22

BMI-body mass index; MM – muscle mass (kg); BF – body fat (kg); BF% - body fat (%); LBM – lean body mass (kg)

The connection between the space of body composition and fitness performance was determined using the method of a cross-correlation analysis (Table 3.). For each of the isolated canonical functions, the value of the canonical correlation (Can R), the coefficient of determination (Can R²), and the results of the test of significance using Bartlett's Chi-square test (Chi-sqr.) are shown, where along with the degree of freedom (df) we also find the probability of error when rejecting the null hypothesis (p). The results obtained using the canonical correlation of body composition and fitness performance indicate that two statistically significant factors were isolated (p= .000, p= .028). The first canonical factor explains 70% of the joint variability while the second canonical factor explains 26% of the joint variability.

A further analysis of the results requires the determination of the projection of variables from the space of body composition and fitness performance onto the isolated canonical functions, based on which we can interpret the latent dimensions responsible for the obtained covariability of these two spaces. Table 4. shows the factor structure of the isolated canonical factors.

Table 3. The isolated canonical functions

	Can R	Can R ²	Chi-sqr.	df	p
0	0.84	0.70	91.32	25	.000
1	0.51	0.26	28.40	16	.028

Table 4. A factor structure of body composition and fitness performance

	Body composition		Fitness performance		
	Root 1	Root 2	Root 1	Root 2	
Body mass index (kg/m ²)	-.74	.19	8-Foot Up-and-Go	-.21	-.41
Muscle mass (kg)	-.30	.02	Back Scratch	.93	.25
Body Fat (kg)	-.76	-.39	Chair Sit-and-Reach	.76	-.22
Body Fat (%)	-.93	-.35	2-Minute Step Test	.84	-.34
Lean body mass (kg)	-.15	-.15	30-Second Chair Stand	.22	-.23
			Arm Curl	-.21	-.41

By analyzing the structure of the first and second canonical factor in the space of body composition, we can note that body fat defines both canonical factors the most, irrespective of whether we are dealing with absolute or relative values (Body Fat [kg]; Body Fat [%]) and BMI. These factors can be defined as the factors of subcutaneous fatty tissue and degree of nourishment. The obtained structure of the first canonical factor in the space of fitness performance is best defined by the Back Scratch (.93), 2-Minute Step Test (.84) and the Chair Sit-and-Reach (.76), and can be defined as the factor of flexibility, and aerobic and muscle endurance. The factor structure of the second canonical factor of the fitness performance is best defined by the 8-Foot Up-and-Go (-.41) and the Arm Curl (-.41). This factor can be defined as the factor of agility and upper body strength.

DISCUSSION AND CONCLUSIONS

The canonical correlation analysis of the fitness performance and the components of body composition of elderly men determined a statistically significant connection. The obtained results indicate a very high connection which can be explained by a single canonical function pair, where the correlation had a value of .92 and explains 84% of the joint variability. The factor structure of the canonical function in the space of body composition is best defined by the values of fatty tissue in kilograms, fat in percentage and the Body Mass Index. The obtained results from the space of body composition indicate that the correlation is, to a great extent, determined by the level of body fat (BFkg, BF%, BMI), while the remaining two parameters which evaluate the relative and absolute values of muscle mass (MM% and MMkg) are not statistically significant. The cited correlation is negative, which means that an increase in one group of

variables indirectly influences the other. The space of cardiorespiratory fitness is best determined by the values of absolute oxygen uptake, which are also negative.

Similar results were obtained in a study carried out in New Zealand, where the connection between the parameters of body composition and cardiorespiratory fitness among Somali women living on the territory of New Zealand as refugees was determined. The obtained results for the population of Somali women indicated a high connection between the BMI and a low level of cardiorespiratory fitness, expressed through maximum oxygen uptake under load (VO₂max). Within this study, the existing differences within the same parameters were determined for the population of women from New Zealand (Guerin, Elmi, & Corrigan, 2007). Based on these results, it would seem that the mechanisms of the connection between body composition and fitness status are very similar among men and women over 60, irrespective of where they reside.

In addition, a study carried out on a population of middle-aged women and men confirmed the existence of a connection between low cardiorespiratory fitness with increased BMI values, citing that the redistribution of adipose tissue as the independent variable, that is, the amount of visceral fat in the body, is a better indicator of low values of the cardiorespiratory index than the BMI (Arsenault et al., 2009). The cited connection has a negative value and speaks in favor of the harmful influence of excess body weight on cardiorespiratory fitness, which was confirmed in numerous studies (Milanovic, Pantelic, Trajkovic, & Sporis, 2011; Milanovic et al., 2013; Pantelić et al., 2013). Certain authors consider the low level of physical fitness to be a greater risk for the occurrence of cardiovascular disease than many conventional parameters such as hypertension, diabetes, smoking or obesity (Lee, Artero, Sui, & Blair, 2010). In addition, Sui et al. (2007) confirmed that the indicators of physical fitness are a significant predictor of the mortality rate among the elderly, irrespective of their overall or abdominal obesity. Increased BMI is significantly related to the poor functioning of the upper and lower body, but not with strength and coordination. However, the BMI has different effects on specific aspects of physical functions, especially the functions of the upper body, and less so on the functions of the lower body.

Based on their research results, Hoehner, Handy, Yan, Blair, and Berrigan (2011) concluded that increased physical activity among people aged from 18 to 90 has a positive connection with increased cardiorespiratory fitness and a decreased BMI.

It is assumed that increased body mass among the elderly, that is, increased values of the BMI, has a corresponding influence on the performance of everyday activities which require strength, mobility, endurance, and agility/dynamic balance. In addition, it is assumed that obesity decreases the speed of leg movement from the seated to standing position and back, and thus negatively affects leg strength, which has also been confirmed in our study. These results match the results of Apovian et al. (2002) who studied the evaluations of the physical functions of elderly women.

Based on the obtained results, we can conclude that there is a statistically significant connection between body composition and the fitness performance among elderly men. The space of body composition is best determined by the values of body fat and BMI, while in the space of fitness by aerobic and muscle endurance and flexibility. It was concluded that the BMI is the most significant clinical risk factor, which is connected to the cardio-respiratory fitness as well as the overall fitness of the elderly.

ACKNOWLEDGEMENT

This research was carried out as part of the project financed by the Ministry of Science of the Republic of Serbia, entitled "Physical activity and the fitness component of the elderly" (number OI179056), approved in 2010, and which is being carried out by the Faculty of Sports and Physical Education of the University of Nis, Serbia.

REFERENCES

- Apovian, C. M., Frey, C. M., Wood, G. C., Rogers, J. Z., Still, C. D., & Jensen, G. L. (2002). Body mass index and physical function in older women. *Obesity Research, 10*(8), 740-747.
- Arsenault, B. J., Cartier, A., Côté, M., Lemieux, I., Tremblay, A., Bouchard, C., . . . Després, J.-P. (2009). Body composition, cardiorespiratory fitness, and low-grade inflammation in middle-aged men and women. *The American journal of cardiology, 104*(2), 240-246.
- Daley, M. J., & Spinks, W. L. (2000). Exercise, mobility and aging. *Sports Medicine, 29*(1), 1-12.
- Guerin, P. B., Elmi, F. H., & Corrigan, C. (2007). Body composition and cardiorespiratory fitness among refugee Somali women living in New Zealand. *Journal of Immigrant and Minority Health, 9*(3), 191-196.
- He, W., Sengupta, M., Velkoff, V. A., & DeBarros, K. A. (2005). *65+ in the United States, 2005*: Citeseer.

Heath, E. H. (2005). ACSM's guidelines for exercise testing and prescription. *Medicine & Science in Sports & Exercise*, 37(11), 2018.

Hoehner, C. M., Handy, S. L., Yan, Y., Blair, S. N., & Berrigan, D. (2011). Association between neighborhood walkability, cardiorespiratory fitness and body-mass index. *Social science & medicine*, 73(12), 1707-1716.

Lee, D., Artero, E. G., Sui, X., & Blair, S. N. (2010). Review: Mortality trends in the general population: the importance of cardiorespiratory fitness. *Journal of Psychopharmacology*, 24(4), 27-35.

Medved, R. (1987). Sportska medicina (Sports medicine). *Zagreb: Jumena*.

Milanovic, Z., Pantelic, S., Trajkovic, N., & Sporis, G. (2011). Basic anthropometric and body composition characteristics in elderly population: A Systematic Review. *Facta Universitatis Series Physical Education and Sport*, 9(2), 173-182.

Milanovic, Z., Pantelic, S., Trajkovic, N., Sporis, G., Kostic, R., & James, N. (2013). Age-related decrease in physical activity and functional fitness among elderly men and women. *Clinical Intervention in Aging*, 8, 549-556.

Nagamatsu, T., Oida, Y., Kitabatake, Y., Kohno, H., Egawa, K. i., Nezu, N., & Arao, T. (2003). A 6-year cohort study on relationship between functional fitness and impairment of ADL in community-dwelling older persons. *Journal of epidemiology*, 13(3), 142-148.

Pantelić, S., Kostić, R., Djurasković, R., Uzunovic, S., Milanovic, Z., & Trajkovic, N. (2013). R

The relationship between physical fitness, BMI and WHR with hypertension in elderly men and women. *Slovenian Journal of Public Health*, 52(4), 275-284.

Rikli, R. E., & Jones, C. J. (2001). *Senior fitness test manual*. Champaign, IL: Human Kinetics.

Sui, X., LaMonte, M. J., Laditka, J. N., Hardin, J. W., Chase, N., Hooker, S. P., & Blair, S. N. (2007). Cardiorespiratory fitness and adiposity as mortality predictors in older adults. *Jama*, 298(21), 2507-2516.

Tuna, H. D., Edeer, A. O., Malkoc, M., & Aksakoglu, G. (2009). Effect of age and physical activity level on functional fitness in older adults. *European Review of Aging and Physical Activity*, 6(2), 99-106.

United Nations. World population prospects: the 2004 revision. New York: United Nations, 2005

A comparison of the static balance of children with and without visual impairment

Slavoljub Uzunović¹, Goran Zdravković², Radmila Kostić¹, Saša Pantelić¹,
Zoran Milanović¹, Bojan Jorgić¹, Marko Aleksandrović¹

¹ Faculty of Sport and Physical Education, University of Niš, Serbia

² Clinic for Ophtamology, Clinic center Niš, Serbia

ABSTRACT

The aim of this research was to determine the differences in the static balance between visually impaired participants and participants with no visual impairment. The sample of participants consisted of 57 children, divided into two sub-samples, a sub-sample of the visually impaired (n=31) and a sub-sample of children with no visual impairment (n=26). In the study, the following tests of balance were applied: 1) the Bass test lengthwise; 2) the Bass test crosswise; 3) the standing balance test; 4) the lengthwise balance test. In the studied balance tests, performed in the eyes open condition, a statistically significant difference ($p < 0.05$) was determined between children with and without visual impairment for the standing balance test (3.33 ± 1.82 vs. 7.75 ± 3.54 , $p = 0.000$) and the lengthwise balance test (2.18 ± 0.68 vs. 7.33 ± 3.44 , $p = 0.000$). The results indicate that there is a statistically significant difference between the tested variables of balance in the eyes open and eyes closed conditions among children with and without visual impairment. Contrary to that, among children with visual impairment, only the variable of the standing balance test indicated statistically significant differences for the eyes open and eyes closed condition ($p < 0.05$). In conclusion, the present study demonstrates large differences between children with and without visual impairment on the single-leg balance test performance, while the performances on the two-leg tests are similar.

Key words: *balance, eyes open, eyes closed, visually impaired children*

INTRODUCTION

Almost 80-90% of information contained in the mind was observed through visual perception (Barati, Barati, Gaeni, & Ghanbarzadeh, 2013). One

of the disabilities that most people are afraid of are blindness and poor vision because of their being more apparent than other types of disabilities, as well as the role of the eyes in social relations (Barati et al., 2013). Previous studies confirmed that blindness or visual impairment can cause low physical work capacity, postural problems, orientation difficulties, depression and problems with balance (Abolfotouh & Telmesani, 1993; Çolak, Bamaç, Aydin, Meriç, & Özbek, 2004; Portfors-Yeomans & Riach, 1995; Sundberg, 1982). Active participation in regular physical activity during childhood can aid the development of various motor abilities, as well as prevent many chronic and acute conditions.

The benefit of sport and physical activity for the visually impaired and blind were studied before, and all the authors confirmed the positive influence of different sports activities (Çolak et al., 2004). However, children with disabilities are more physically unfit due to physical and psychosocial constraints (Longrnuir & Bar-Or, 2000). In additional, few studies confirmed that children with visual impairment have a lower level of health-related physical fitness than their sighted peers (Kozub & Oh, 2004; Lieberman, Houston-Wilson, & Kozub, 2002). Further, the same authors did not observe a statistically difference between the fitness score of children with poor vision and those who are blind. However, the differences in motor abilities as well as balance between children who are visually impaired and those without any impairment are still unclear. Balance presents one of the major component in people with visual impairment in terms of their normal lifestyle, especially related to walking activities.

How an individual is able to maintain balance in space, especially if they are unstable, is assumed to depend on, in addition to other things, the level of the other motor skills and motor habits that the individual possesses. For the visually impaired, maintaining balance on a supporting surface which is more narrow than the surface of their foot is a particular problem. Children with various degrees of visual impairment do not acquire motor skills which other children acquire early on in life, which is why they are in need of special training for particular skills, including the development of balance and orientation and movement in space.

The aim of this study was to determine the differences in the static balance between visually impaired children and children with no visual impairment. The results obtained on the tests for static balance performed in the eyes closed and eyes open conditions were compared. It is assumed that differences will be determined between children with and without visual impairment.

METHODS

The sample of participants

The sample of participant numbered 57 children divided into two sub-samples (the sub-sample of the visually impaired children, and children with no visual impairment).

The sub-sample of children with visual impairment numbered 31 male and female schoolchildren aged 11 to 12 who attend the school for visually impaired children in Belgrade, Zemun, and Novi Sad, in the Republic of Serbia. The average body height of the participants is 142,67cm ($SD \pm 9,50$) while the average body weight is 40,19 kg ($SD \pm 7,26$). The study included participants who in terms of the extent of their impairment belonged to the categories of individuals with *mid and high level of impairment*, that is, belonged to the *second and third category of impairment* (Mitrović & Stefanović, 1990, pg. 201) compared to the sharpness of their vision based on the criteria of the World Health Organization (WHO).

The sub-sample of participants with no visual impairment numbered 26 male and female children who attended the Filip Filipović Elementary School in Niš, and who were healthy on the day of testing. Their average body height was 149,73 ($SD \pm 8,63$), while their body weight was 41,81 ($SD \pm 10,45$).

For all of the participants, permission for testing was obtained from the school authorities.

The sample of measuring instruments

Partially modified tests of balance were used in this study (Tkalčić, 1981), and which were assigned to the participants with no visual impairment. Both sub-samples of participants performed each test in two different ways. One way was in the eyes open condition, and the other in the eyes closed condition.

When performing the test in the eyes closed condition, the following procedure was adhered to: when assuming the balance position, the eyes remained open. Once the position was assumed, the eyes were then closed. When the balance position was interrupted, the test was considered to be over, the measuring stopped, and the participant then opened his eyes.

The following tests were used:

1. *The Bass test lengthwise*
2. *The Bass test crosswise*
3. *The standing balance test*
4. *The lengthwise balance test.*

A description of measuring instruments

The Bass test lengthwise. Holding on to the shoulders of the invigilator or an assistant, the barefoot participant stands lengthwise on the balance beam, standing one foot in front of the other, with his whole foot on the ground, and with his hands on his hips. The task is to maintain a balance position for as long as possible. The invigilator stops the measuring when the participant loses his balance by descending from the beam with either foot or when he removes his hands from his hips. Time is measured in the tenths of a second, until the position is disrupted or the test is over. The test is performed three times with short breaks in between. For further analysis, the mean value from all three tests is recorded. Equipment: a balance beam and a stopwatch.

The Bass test crosswise. Holding on to the shoulders of the invigilator or an assistant, the barefoot participant stands crosswise on the balance beam, on the balls of his feet, and with his hands on his hips. The task is to maintain a balance position for as long as possible. The invigilator stops the measuring when the participant loses his balance by descending from the beam with either foot or when he removes his hands from his hips. Time is measured in the tenths of a second, until the position is disrupted or the test is over. The test is performed three times with short breaks in between. For further analysis, the mean value from all three tests is recorded. Equipment: a balance beam and a stopwatch.

The standing balance test. Barefoot, the participant stands on one leg with his whole foot on the floor. The other foot is resting against the inside of the knee of the leg he is standing on. The palms of his hands are placed firmly on his thighs. The task is to remain in the balance position for as long as possible in the eyes closed position. The invigilator stops the measuring when the participant moves his bent leg by separating it from the leg he is standing on, or when he moves his hands from his thighs. Time is measured in the tenths of a second, until the position is disrupted or the test is over. The test is performed three times with short breaks in between. For further analysis, the mean value from all three tests is recorded. Equipment: a stopwatch.

The lengthwise balance test. The participant stands on the ground on the balls of both feet. Once he assumes a balance position, he then places his hands on his hips. The task is to maintain a balance position for as long as possible in the eyes closed position. The invigilator stops the measuring when the participant places his whole foot on the floor, or when he removes his hands from his hips. Time is measured in the tenths of a second, until the position

is disrupted or the test is over. The test is performed three times with short breaks in between. For further analysis, the mean value from all three tests is recorded. Equipment: a stopwatch.

Statistical analysis

Data analysis was performed using the Statistical Package for the Social Sciences (v13.0, SPSS Inc., Chicago, IL, USA). The differences between children with and without visual impairment were obtained using the T-test. The Kolmogorov-Smirnov tests showed that the data were normally distributed and no violation of homogeneity of variance was found using Levene's test. The level of statistical significance was set at $p < 0.05$.

RESULTS

Table 1. The basic descriptive statistics parameters of static balance of the children with and without visual impairment (eyes open condition)

	Visually impaired		No visual impairment		p
	Mean±SD	Min-Max	Mean±SD	Min-Max	
the Bass test lengthwise	3.22±1.65	1.30-8.82	3.03±0.86	1.48-5.27*	0.601
the Bass test crosswise	2.65±1.23	0.98-6.19	2.83±0.47	1.75-3.70*	0.517
the standing balance test	3.33±1.82	1.28-7.71*	7.75±3.54	0.83-14.00*	0.000
the lengthwise balance test	2.18±0.68	0.97-3.90	7.33±3.44	3.02-12.70*	0.000

* - a statistically significant difference for the eyes open and eyes closed condition

In the studied tests of balance in the eyes open condition, a statistically significant difference was determined ($p < 0.05$) between children with and without visual impairment for the variables of the standing balance test (3.33 ± 1.82 vs. 7.75 ± 3.54 , $p = 0.000$) and the lengthwise balance test (2.18 ± 0.68 vs. 7.33 ± 3.44 , $p = 0.000$). For the remaining variables no difference was determined between the children with and without visual impairment, in the eyes closed condition (Table 1). Identical results were noted even when the variables for balance were tested in the eyes closed condition, when a statistically significant difference was determined for the same variables as for the eyes open condition (Table 2).

The results indicate a statistically significant difference between the tested variables of balance in the eyes open and eyes closed conditions for children

with and without visual impairment. All of the variables of balance showed a statistically significant difference between the eyes open and eyes closed condition. Contrary to that, among the children with visual impairment, only the standing balance test variable indicated a statistically significant difference between the eyes open and eyes closed condition ($p < 0.05$, Table 1).

Table 2. The basic descriptive statistics parameters of static balance for children with and without visual impairment (the eyes closed conditions)

	Visually impaired		No visual impairment		p
	Mean±SD	Min-Max	Mean±SD	Min-Max	
The Bass test lengthwise	2.67±0.88	1.03-4.64	2.52±0.45	1.82-3.37	0.418
The Bass test crosswise	2.46±0.90	1.07-5.41	2.35±0.50	1.59-3.33	0.588
The standing balance test	2.46±1.03	1.08-6.35	3.78±1.78	0.95-7.29	0.001
The lengthwise balance test	2.30±0.94	0.86-4.56	3.54±1.53	1.70-7.22	0.000

DISCUSSION AND CONCLUSION

This study aimed to investigate the differences in balance performance between children with and without visual impairment. The major findings were that children without visual impairment scored higher values on the test of single-leg balance abilities, while for the two leg balance tests no difference was determined between children with and without impairment. However, in all the tested variables, differences in performance were observed between the eyes open and eyes closed conditions among children without visual impairment, while children who with visual impairment showed similar results for eyes open and eyes closed conditions, except for the single leg standard balance test.

A decrease in the visual potential among visually impaired children does not allow the input of sufficient high-quality information for maintaining body balance. Peripheral vision, among other things, signals a change in body position, so that its weakening, which often accompanies poor eyesight, leads to problems with balance. In addition, visually impaired children are often confronted with difficulties in adequate responses to information which they receive via visual and proprioceptive means, which disturbs their balance responses (Bouchard & Tetreault, 2000).

One of the reasons for differences between children with and without visual impairment are the anticipated developmental delays in mobility skills

among those visual impairment (Troster, Hecker, & Brambring, 1994). Also, fine motor manipulation and coordination are lower in children with visual impairment, which influences balance performance. This in particular pertains to single-leg balance because children with disabilities have decreased levels of balance and postural stability, as well as problems in the projection of center of gravity and stability area. These findings are confirmed in our study, which means that more training interventions are necessary to investigate the effects of exercise on the single-leg balance among children with visual impairment.

Gipsman (1981) studied the differences in balance between individuals with extremely poor eyesight and emmetropes, with both groups of participants wearing blindfolds, and determined very similar results, which were approximately four times worse than the results scored by children with no visual impairment, without blindfolds. It was concluded that children with poor eyesight, who are unable to rely on their sight in the performance of balance tasks, scored worse results than the blind children. In addition, Grbović (2007) determined that the overall physical fitness of children with visual impairment, compared to children without visual impairment, was lower, irrespective of their age and gender. It was determined that visually impaired children achieved better results on tests that require the local activation of muscle groups, while for the tests which require good visual-motor control, significant differences were manifested between them and children without visual impairment. A significantly lower level of speed, endurance, balance and agility of the visually impaired children was determined, which is in accordance with the results obtained in this study.

In conclusion, the present study demonstrates significant differences between children with and without visual impairment on single-leg balance performance, while on the two-leg performance their results are similar. We did not observe differences between the eyes open and eyes closed conditions for the same test for children with visual impairment, while children without visual impairment showed significant differences in the mentioned variables.

REFERENCES

Abolfotouh, M., & Telmesani, A. (1993). A study of some psycho-social characteristics of blind and deaf male students in Abha City, Asir Region, Saudi. *Public Health*, 107(4), 261-269.

Barati, S. A., Barati, A. A., Gaeeni, S., & Ghanbarzadeh, M. (2013). Comparing the effect of combination of mental and physical practices on balance capa-

bility of students with vision disorders. *International Journal of Sport Studies*, 31(1), 80-85.

Bouchard, D., & Tetreault, S. (2000). The motor development of sighted children and children with moderate low vision aged 8–13. *Journal of Visual Impairment & Blindness (JVIB)*, 94(09).

Çolak, T., Bamaç, B., Aydin, M., Meriç, B., & Özbek, A. (2004). Physical fitness levels of blind and visually impaired goalball team players. *Isokinetics and Exercise Science*, 12(4), 247-252.

Gipsman, S. C. (1981). Effect of Visual Condition on Use of Proprioceptive Cues in Performing a Balance Task. *Journal of visual impairment and blindness*, 75(2), 50-54.

Grbović, A. (2007). Ispitivanje fizičkih sposobnosti slabovidih učenika-gipkost (An analysis of the physical abilities of children with visual impairment - agility). *Beogradska defektološka škola*, 3(1-8).

Kozub, F., & Oh, H. (2004). An exploratory study of physical activity levels in children and adolescents with visual impairments. *Clinical Kinesiology*, 58(3), 1-7.

Lieberman, L. J., Houston-Wilson, C., & Kozub, F. M. (2002). Perceived barriers to including students with visual impairments in general physical education. *Adapted Physical Activity Quarterly*, 19, 364-377.

Longnuir, P. E., & Bar-Or, O. (2000). Factors influencing the physical activity levels of youths with physical and sensory disabilities. *Adapted Physical Activity Quarterly*, 17(40), 40-53.

Portfors-Yeomans, C. V., & Riach, C. L. (1995). Frequency characteristics of postural control of children with and without visual impairment. *Developmental Medicine and Child Neurology*, 37(5), 456-463.

Sundberg, S. (1982). Maximal oxygen uptake in relation to age in blind and normal boys and girls. *Acta Paediatrica*, 71(4), 603-608.

Tkalčić, S. (1981). Metrijske karakteristike testova za mjerenje ravnoteže kod žena (The metric characteristics of tests used to measure balance among women). *Kinesiology*, 12(1), 43-52.

Troster, H., Hecker, W., & Brambring, M. (1994). Longitudinal study of gross-motor development in blind infants and preschoolers 1. *Early Child Development and Care*, 104(1), 61-78.

Differences between various household income backgrounds in relation to objective measured physical activity in Czech elementary school-aged children

Damir Bešić, Vlado Balaban

Faculty of Physical Culture, Palacky University, Olomouc, Czech Republic

ABSTRACT

Despite of having a lot of evidence how socioeconomic status (SES) in many ways influences a child's quality of life, there is still insufficient information about how SES impacts child's daily physical activity (PA). **Objective:** This study examined differences between various household income (low, middle and high) in relation to time spent in different levels of PA and step counts in Czech elementary school-aged children. **Method:** Ninety children aged 9-11 participated in this study. They were divided into three SES groups on the base of monthly household income. Child's PA was measured for four consecutive days including one weekend day. Physical activity was measured using ActiGraph models GT3X and GT3X+. Differences between the groups were tested using analysis of covariance (ANCOVA). Body mass index (BMI) was considered as a covariate. **Results:** Children from high-SES group spent significantly more time ($p = .04$) in vigorous physical activity (VPA) and took fewer steps per day ($p = .02$) than their counterparts from low-SES group. There were no differences across groups in relation to time spent in light physical activity (LPA) and moderate physical activity (MPA) as well. **Conclusion:** The results of this study indicate the need for the promotion of VPA in children from families with low SES.

Keywords: socioeconomic status, ActiGraph, body mass index, vigorous physical activity

INTRODUCTION

An increasing number of research studies suggest that there are numerous physical, psychological and social benefits of PA for children (Curie et al.,

2012). Child's daily PA patterns are influenced directly or indirectly by many factors (Bauman et al., 2012). Bauman et al. emphasize the importance of identifying and understanding of correlates and determinants that influence PA in children. According to them, exploring factors associated with different levels of PA could help society to better understand why there are some individual less physically active and also could help in planning and organizing public health interventions in this field. There is a lot of evidence from different studies which confirm the fact that SES influences quality of child's life in many ways. However, there is still inconsistent information about how SES impact child's daily PA. Curie et al. (2012) claim that low SES may affect different areas of social life. Reilly (2005) recognize SES as a factor that contributes to risk for overweight and obesity in children. Reilly also reported that children who come from low-SES families have greater BMI than those who come from families with high-SES background. Sulemana et al. (2006) underlined that higher BMI is related to lower physical activity levels. The Health Behavior in School-aged Children (HBSC) study has found association between family affluence and young people's health (Curie et al., 2012). Curie et al. also found that children from families with low household incomes had less opportunity to participate in fee-based physical activity, especially in sports and activities that require expensive equipment or lessons. According to Drenowatz et al. (2010) the level of child's PA significantly correlates with socio-economic conditions of the family. Drenowatz et al. found that children from the low-SES families were less active and spent more time in sedentary behavior than high-SES children. Results from study conducted by Baquet et al. (2014) showed that children who belonged to high-SES group spent significantly more time in MPA and VPA than those from low-SES group during school recess. The purpose of this study was to examine differences between various household income (low, middle and high) in relation to time spent in different levels of PA and step counts in children.

METHOD

Subjects were randomly selected children from two public elementary schools located in the city of Olomouc, Czech Republic. A total of 90 children (44 boys, 46 girls) aged 9-11 participated in this study. The study had been previously approved by authorities at the individual schools. Prior to data collection, informed written consent was obtained from parents. Data collection took place during November 2013. Outcomes related to family's SES were

based on parental reports using Environmental Stimulus for Physical Activity (ESPA) questionnaire from authors Vanreusel and Renson. This questionnaire is made to assess child's level of stimulation to PA, both in the family and in school. The questionnaire is divided in two parts. For this study we used only the first part of this questionnaire which is related to family's SES. To get objectively information about SES we added one more question with regard to family's monthly household income. SES indicator was determined based on monthly household income divided by the number of family members. According to Regional Administration Czech Statistical Office the families should be grouped into four groups (< 8,000 CZK; 8,000-10,000 CZK; 10,001-15,000 CZK; > 15,000 CZK). Due to the smaller sample size in the present study subjects were grouped into three groups (Low < 8,000 CZK; Medium 8,000-15,000 CZK; High > 15,000 CZK). Child's BMI was measured using the body composition analyzer InBody 720. Weight status was classified as normal, overweight or obese using age- and sex-specific BMI cut-off points. Objective assessments of physical activity behavior were obtained using the ActiGraph activity monitors GT3X and GT3X+. Both models have small size and mass and contain a tri-axial accelerometer for assessing accelerations in the vertical, anterior-posterior and medio-lateral axes. Also they include an inclinometer which detects if subject is in the standing or lying position or when ActiGraph is off (non-wear period). During the study children are asked to wear the ActiGraph on the hip. ActiLife software was used for initializing the monitors and downloading the data. Only data from children who wore the accelerometer at least ten hour per day, for four consecutive days, including one weekend day were taken in consideration. Physical activity cut-off points for children were determined according to Freedson (Freedson et al., 2005): Light 150-499 cut-points per minute (CPM), Moderate 500-3,999 CPM, Vigorous > 4,000 CPM. Activity monitors were set to record movement counts in 1-min epochs. Outcome variables derived from the GT3X and GT3X+ were presented as mean minutes per day spent in different levels of PA and as mean step counts per day as well. All statistical analyses in this study were carried out using commercially available software STATISTICA 12 and $p < .05$ was considered as the level of statistical significance. Descriptive statistics are expressed as means, standard deviations and percentages. Differences in age and BMI across SES groups were tested using univariate analysis of variance (1-way ANOVA). Differences between SES groups in the relation to the level of physical activity and step counts were tested using analysis of covariance (ANCOVA) Participants' BMI was considered

as covariates. Significant ANOVA/ANCOVA results were followed up using the Fisher's LSD post hoc test.

RESULTS

Table 1: Descriptive statistics of participants

	Low SES	Middle SES	High SES	Total
Number of children (boys/girls)	36 (17/19)	35 (18/17)	19 (9/10)	90 (44/46)
Age M (SD)	9.8 (0.7)	9.7 (0.7)	9.5 (0.6)	9.7 (0.7)
BMI M (SD)*	17.6 (3.1)	17.9 (2.7)	16.1 (1.9)	17.4 (2.8)
Number of obese-overweight	8 (9%)	10 (11%)	1 (1%)	19 (21%)

Note. BMI = body mass index, M = mean, SD = standard deviation. *Significant difference (ANOVA) between high-SES and middle-SES at $p < .05$.

Descriptive characteristics of the subjects are presented in Table 1. Based on SES indicator almost the same number of participants belonged to low-SES group (40%) and middle-SES group (39%) whereas 21% were from families with high household income background. There were no significant differences between SES groups in relation to age of participants. Total of 21% children were classified as obese or overweight of which only 1% come from high-SES group. Statistically significant difference was occurred between middle-SES and high-SES groups in relation to BMI ($p = .02$). Children from high-SES showed less BMI value than children from the other two SES groups.

Table 2: Differences between SES groups in relation to time spent at different level of PA (min/day) and step counts (steps/day) controlling for BMI, presented as mean and standard deviation

PA levels	SES groups			Low-Middle p value	Low-High p value	Middle-High p value
	Low	Middle	High			
LPA	139.6 (28.9)	138.6 (27.1)	135.7 (24.7)	.87	.59	.69
MPA	200.4 (64.5)	193.4 (41.9)	216 (51.9)	.59	.31	.14
VPA	9.9 (9.2)	11.1 (12.6)	16.4 (10.4)	.66	.04*	.09
Steps	9570.6 (2816.2)	9961.3 (3081.4)	11587.8 (3323.3)	.60	.02*	.07

Note. SES = socio economic status; SD = standard deviation; LPA = light physical activity; MPA = moderate physical activity; VPA = vigorous physical activity. *Significant differences (ANCOVA) between low-SES and high-SES at $p < .05$.

Table 2 shows differences between three household income groups in relation to time spent at different level of PA and step counts controlling for BMI. Statistically significant differences were found between groups in relation to VPA and step counts as well. High-SES children spent significantly more time in VPA ($p = .04$) and also took significantly more steps per day ($p = .02$) than their counterparts from low-SES. There were no statistical differences between all three groups in relation to LPA and MPA.

DISCUSSION

The aim of this study was to examine differences between various household income (low, middle and high) in relation to the time spent in different levels of PA and step counts in children. The results from the present study confirm the statement that child's PA is a complex, multifactor issue and are influenced by many factors (Sallis & Owen, 2008). Descriptive statistic from the present study showed that most obese/overweight children were in the low-SES group and in the middle-SES group as well. As a result, children from the high-SES group showed generally less value of the BMI. Findings from study conducted by Drenowatz et al. (2010) support our claims regarding to correlation between SES and BMI. They found that low-SES children had a higher BMI than children from high-SES families. Our findings clearly demonstrate that with increasing household income per person, also increased the time children spent at the level of VPA. At this PA level statistically significant difference was occurred between children that belonged to the high-SES group and those from low-SES background. It is already well known that vigorous intensity of PA offers additional health benefits for children (Janssen & LeBlanc, 2010) and it is interesting that in the present study statistical difference between SES groups occurred at the level of VPA. Gutin et al. (2005) found that particularly VPA were strongly negatively associated with fatness which implies that in our study BMI had an impact on child's PA. Curie et al. (2012) reported that potential reason why differences occurred could be because children from the low-SES families have less opportunity to participate in fee-based physical activity. Findings from this study suggest that public health promoting actions should be focused on children who come from families with low SES background. In our study children from lower SES families had a greater BMI, spent significantly less time at VPA level and took significantly fewer steps than children who come from high SES families. There are few limitations of this study that should be mentioned. The sample used in the present study was small and

is not representative. The cross-sectional design is not useful if we search for causal explanation and on the base of the results we could not determine what caused differences, although it is evident that the differences exist. To get the objective and useful data related to relation between child's PA and SES, further research should be based on longitudinal designs and it should take in account ecological model in research of correlates related to PA, which is based on multidimensional and transdisciplinary approaches (Sallis & Owen, 2008).

CONCLUSION

The results from the current study show that low-SES children spent significant less time at the VPA level. They had a higher BMI and also took significantly fewer steps per day than children who belonged to the high-SES group.

REFERENCES

Baquet, G., Ridgers, N. D., Blaes, A., Aucouturier, J., Van Praagh, E., & Berthoin, S. (2014). Objectively assessed recess physical activity in girls and boys from high and low socioeconomic backgrounds. *BMC Public Health*, *14*(1), 1-12. doi:10.1186/1471-2458-14-192

Bauman, A. E., Reis, R. S., Sallis, J. F., Wells, J. C., Loos, R. J., & Martin, B. W. (2012). Correlates of physical activity: Why are some people physically active and others not? *The Lancet*, *380*(9838), 258-271.

Currie, C. et al. (2012). *Social determinants of health and well-being among young people: Health behavior in school-aged children (HBSC) study: international report from the 2009/2010 survey*. Copenhagen: World Health Organization.

Drenowatz, C., Eisenmann, J. C., Pfeiffer, K. A., Welk, G., Heelan, K., Gentile, D. & Walsh, D. (2010) Influence of socio-economic status on habitual physical activity and sedentary behavior in 8- to 11-year old children. *BMC Public Health*, *10*, 214-224. doi:10.1186/1471-2458-10-214

Freedson, P. S., Pober, D., & Janz, K. F. (2005). Calibration of accelerometer output for children. *Medicine Science of Sports Exercise*, *37*(11), 523-530.

Gutin, B., Yin, Z., Humphries, M. C., & Barbeau, P. (2005). Relations of moderate and vigorous physical activity to fitness and fatness in adolescents. *The American Journal of Clinical Nutrition*, *81*(4), 746-750.

Janssen, I., & LeBlanc, A. G. (2010). Review Systematic review of the health benefits of physical activity and fitness in school-aged children and youth. *International Journal of Behavioral Nutrition and Physical Activity*, *7*(40), 1-16.

Reilly, J. J. (2005). Descriptive epidemiology and health consequences of childhood obesity. *Clinical Endocrinology and Metabolism*, 19(3), 327–341.

Sallis, J. F. & Owen, N. (2008). Ecological models of health behavior. In K. Glanz, F.M. Lewis, & B.K. Rimer (Eds.), *Health behavior and health education: Theory, research and practice* (pp. 465–482). San Francisco, CA: Jossey-Bass.

Sulemana, H., Smolensky, M. H., & Lai, D. (2006). Relationship between physical activity and body mass index in adolescents. *Medicine and Science in Sports and Exercise*, 38(6), 1182-1186.

Serum visfatin levels and physical fitness in normal and overweight subject

Mihaela Jurdana^{1,2}, Ana Petelin¹, Zala Jenko Pražnikar¹

¹University of Primorska, Faculty of Health Sciences Izola, Slovenia

²University of Primorska, Science and research centre Koper, Institute for kinesiology, Koper, Slovenia

ABSTRACT

The article focuses on a potential association between physical activity, serum visfatin levels and obesity. Visfatin is a highly expressed protein located predominantly in visceral adipose tissue and has been linked to obesity and increased health risks. Physical activity has an important effect on adipose tissue, probably affecting visfatin concentrations. This study included 48 overweight and 48 control middle-aged participants without any previous health problems. We assessed physical fitness index (FI) according to UKK walk test programme and measured serum visfatin levels. In conclusion, our findings demonstrated low visfatin levels in participants with higher fitness index.

Key words: plasma visfatin, physical fitness, adipose tissue, overweight

INTRODUCTION

Visfatin is recently discovered adipocytokine, secreted by adipose tissue. It is highly expressed in visceral fat and was revealed to be associated with increased obesity (Fukuhara et al., 2005). Soon after, Choi et al. showed that the level of visfatin was higher in obese participants as compared with that in non-obese participants among Korean women. They also showed that plasma visfatin can be lowered after body weight reduction by an exercise programme, and this result also held for non-obese subjects. This evidence supports the hypothesis that plasma visfatin concentrations are largely determined by body weight, probably mainly by visceral adipose tissue. The physiological role of

visfatin is not completely understood, nevertheless, the discovery of this adipokine has great potential for enhancing understanding of the pathogenesis of obesity (Choi et al., 2007).

Visceral obesity is known to be an important risk factor for the development of insulin resistance (IR), type 2 diabetes and cardio-vascular diseases in adults. These findings indicate that hyperinsulinaemia and insuline resistance (IR) can be considered as early signs of metabolic syndrome. Furthermore, weight loss after a hypocaloric diet or exercise training showed decreased plasma visfatin levels in obese patients (Enevoldsen et al., 2004). Dong-il and colleagues demonstrated that supervised program that combined resistance training with aerobic exercise is effective in modifying factors related to metabolic syndrome and lowering visfatin levels (Dong-il et al., 2011).

Only limited studies that reported the effects of exercise on circulating visfatin are available. Several studies suggest that exercise training with weight loss induces reduction of plasma visfatin concentration that is accompanied by benefits to body composition, metabolic syndrome factors, and IR. (Seo et al., 2011; Haus et al., 2009; Jurdana et al., 2013). Most recent studies have examined the effects of aerobic exercise training or a combination of resistance training and aerobic exercise training on plasma visfatin level, IR, and body composition in overweight or obese individuals (Choi et al., 2007; Matinhomae et al., 2014). Increasing evidence suggests that high-intensity interval training (HIIT) through positive changes in hormone secretion and enzymatic adaptation can effectively improve abdominal and subcutaneous fat loss, IR, fat oxidation, appetite regulation, and aerobic capacity (Matinhomae et al., 2014). So, changes in nutritional status, exercise, eating behaviour have important effects on adipose tissue metabolism and may affect visfatin concentrations (Enevoldsen et al., 2004).

The aim of the present study was to investigate the role of visfatin in normal weighted and overweight adults in respect to physical fitness, which generally increases with increased physical activity.

METHODS

Participants

In the study, 96 healthy participants (66% females and 34% males) aged 30-49 years with no history of disorders were selected. The study was approved by the Slovenian National Medical Ethics Committee and was performed in

accordance with the ethical standards laid down in the 1964 Declaration of Helsinki. All volunteers were fully informed of the procedures before written consent was obtained. The project was carried out between October and December 2011 at the University of Primorska, Faculty of Health Sciences, Izola, Slovenia.

Measurement of body composition

At the study site height, weight and waist circumference were measured, as well as blood pressure using a standardized protocol. All measurements were performed between 7 and 8 a.m. in the morning after fasting overnight by same examiner. Subject height was measured to the nearest 0.1 cm in a standing position, without shoes, using Leicester Height Measure (Invicta Plastics Limited, Oadby, England). Body weight of the participants wearing usual light indoor clothing without shoes was measured with a 0.1 kg precision. Waist was measured in standing position halfway between costal edge and iliac crest, whereas hip was measured as the greatest circumference around the buttocks. BMI and waist to hip ratio were calculated using the formulas: weight (kg)/height (m²) and waist (cm)/hip (cm), respectively.

Testing Physical fitness

Physical fitness was assessed to predict maximal oxygen uptake and to measure the ability of brisk walking. Functional status was assessed by reported estimate on ability to low intensity walking on 2 km according to UKK walk test programme. The walking time was recorded; the pulse rate was measured at the cervical aorta by 15 seconds and multiplies by 4. Fitness index (FI) was calculated on the base of mentioned programme developed by UKK Institute for health promotion research, Tampere, Finland (Fitness for Health, 2002), (based on age, BMI, walking time and pulse by the following formulas: for male: $[I= 420 + A*0,2 - T*11,6 - P*0,56 - BMI*2,6]$ and for female: $[I= 304 + A*0,4 - T*8,5 - P*0,32 - BMI*1,1]$, whereas A= age; T= time walking in minutes, seconds; P= pulse; BMI= body mass index. Interpretation of FI measurements is: 1) FI < 70 (significantly low), 2) FI 70-89 (under average), 3) FI 90-100 (average), 4) FI 111-130 (above average), and 5) FI > 130 (significantly high).

Assessment of physical activity by questionnaire

The Physical questionnaire AMA was used to assess the physical activity. The questionnaire collected information on the time spent performing physi-

cal activity (number of sessions and average time per session), sedentary pursuits; essentially sitting and physical activity barriers.

Serum measurements

Venous blood samples for biochemical and hormonal determinations were taken on an empty stomach in the morning (between 8 and 9 a.m.) into 4 mL vacuum test tubes (Beckton-Dickinson, Rutherford, USA). Serum was immediately separated, frozen and stored at -20 °C until subsequent analysis. Serum visfatin concentrations were measured in duplicate with a human visfatin ELISA Kit (BioVision, Mountain View, CA, USA) performed on microplate reader (Tecan, Männedorf, Switzerland). Assay sensitivity was 30 pg/mL, and interassay and intraassay CVs were <10% and <10%, respectively.

Statistical analysis

Data are presented as means \pm SE unless otherwise stated. Before statistical analysis, data obtained that were not normally distributed were logarithmically transformed to approximate a normal distribution for subsequent analysis (concentrations of visfatin). To investigate the effect of obesity on visfatin serum concentration, subjects were classified in two groups according to adiposity, BMI, and waist circumference. Comparisons of anthropometric, physical and biochemical characteristics between the 2 groups were analysed with independent t-test and with the use of one-factor analysis of the variance with Bonferroni correction. Pearson's correlation analyses were performed to screen potential factors related to fasting serum concentrations of visfatin. The IBM SPSS version 19.0 (SPSS Inc, Chicago, IL) was used for all analyses. P value of less than 0.05 was taken as a statistically significant difference between the tested parameter.

RESULTS

Baseline characteristics of participants

Anthropometric parameters of 48 normal weight (16 male and 32 female participants) and 48 overweight subjects (16 male and 32 female participants) are illustrated in Table 1. No significant differences of age and height were observed between groups, as expected. Significant differences were observed in body weight, BMI, waist and hip circumference, waist to hip ratio (Table 1). Sta-

tistically significant difference regarding physical activity and physical fitness was found. In terms of minutes per week the physical activity was significantly higher in the control group (M/F=214±211/168±117, compared to obese cases group (M/F=89±79/122±82).

Table 1: Anthropometric and other measured parameters of control and participants

	Control group (M/F)	obese group (M/F)	P value (M/F)
Number of participants	16/32	16/32	ns/ns
Age (years)	34.3±6.2/37.7±6.1	37.9±6.3/39.3±6.0	ns/ns
Height (cm)	181±5/168±6	180±6/166±5	ns/ns
Weight (kg)	75.9±9.4/60.1±6.1	95.6±8.2/80.9±9.3	<0.001/<0.001
BMI (kg/m ²)	23.1±2.2/21.4±2.0	29.3±2.9/29.5±2.7	<0.001/<0.001
Waist circumference (cm)	84±7/72±5	100±6/91±7	<0.001/<0.001
Hip circumference (cm)	94±8/92±6	106±5/108±9	<0.001/<0.001
Waist to hip ratio	0.89±0.03/0.79±0.05	0.95±0.04/0.85±0.09	<0.001/<0.001
Physical activity (minutes/week)	214±211/168±117	89±79/122±82	<0.05/<0.05
FI	101±13/111±15	82±18/83±15	<0.05/<0.001

All values are mean ± SE. M, male, F, female; BMI, body mass index; FI, physical fitness.

FI, which is a good indicator for health was also measured and differences between the tested groups were also observed (Table 1). Overweight subjects obtained slow aerobic time (under average) compared to normal weighted subjects. Aerobic time in normal weighted males was higher in compare to overweight, but in the average, and FI above average was observed in normal weighted female participants (Table 1).

Circulating visfatin levels

Our data indicate statistically significant differences in the baseline level of fasting visfatin in our generally healthy, middle aged participants. Baseline level of fasting visfatin as shown in Figure 1 was significantly higher in overweight participants (4.1 ± 0.6 ng/mL for male participant and 4.4 ± 0.5 ng/mL for female participants) compared to normal weighted participants (1.8 ± 0.6 ng/mL for male participants and 2.5 ± 0.5 ng/mL for female participants). No differences were found in visfatin concentrations between genders.

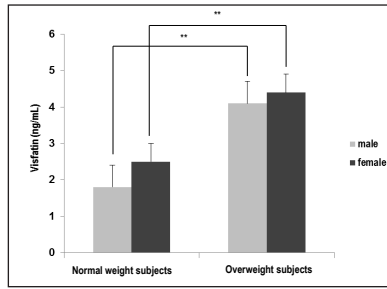

Figure 1: Serum visfatin levels in normal weighted (control) and overweight participants, separately for male and female participants.** P<0.01

Pearson's correlation between serum visfatin levels and FI

Pearson's correlations were performed to investigate the possible associations between fasting serum concentration of visfatin with aerobic physical activity. In both, male and female participants we observed significant negative correlation between serum visfatin and FI ($R^2=0.175$) (Figure 2). Multiple step-wise linear regression analyses confirmed that FI was the only significant predictor of baseline visfatin concentration in male participants (data not shown).

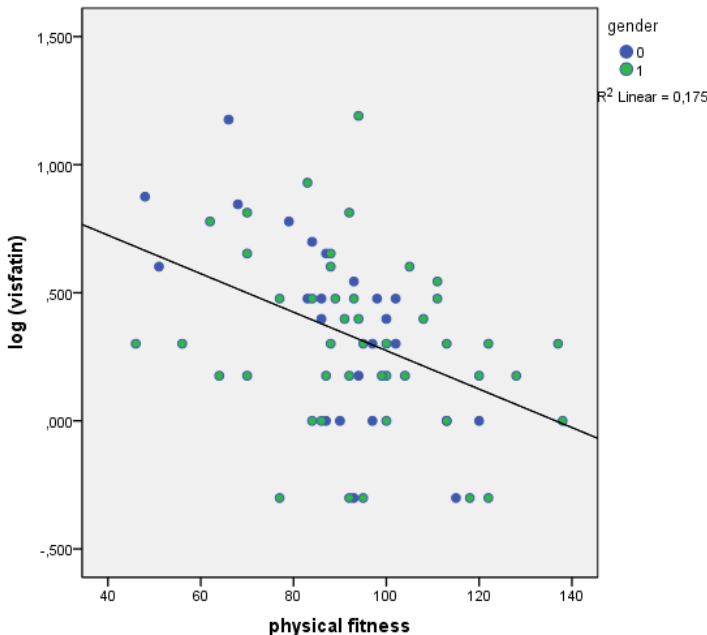

Figure 2: Correlation between physical fitness and visfatin levels in the combined analysis of male and female participants with BMI > 20 kg/m², gender 0, male, 1, female

DISCUSSION AND CONCLUSIONS

Because visceral adipose tissue is considered an important source of visfatin, studies on visfatin alterations in adults may be useful in understanding some of the complications of obesity.

In agreement with other authors (Chang et al., 2011; Zahorska et al., 2007) our results indicate that circulating visfatin levels were higher in overweight participants of both sexes.

To evaluate the importance of physical fitness, we tested the aerobic capabilities of the study participants. We demonstrated an association between exercise training and fasting visfatin levels, as has been shown in a previous study (Choi et al., 2007). Aerobic FI, which generally increases with increased aerobic physical activity, may also attenuate obesity-related mortality (Ross et al., 2000). We found that aerobic FI was negatively and significantly correlated with serum visfatin in both male and female participants. Additionally, FI was confirmed to be the best predictor for fasting visfatin levels in male participants. Choi et al. (2007) reported similar results; a significant reduction was found in circulating visfatin levels after a combined aerobic and resistance exercise training program in overweight and obese participants. In our study an anaerobic assessment also showed that the overweight group was less physically active.

We can conclude that physical activity provides an effective approach for combating the harmful factors associated with increasing body fat mass. Cases of visceral adiposity are usually specified with increased waist circumference, which clearly represents also overall body fatness (Zerbo-Šporin, 2014). It is commonly accepted that at least 150 minutes of moderate-intensity aerobic physical activity throughout the week or do at least 75 minutes of vigorous-intensity aerobic physical activity throughout the week or an equivalent combination of moderate- and vigorous-intensity activity is necessary to realize improvements in health-related outcomes (WHO, 2015). We found that the quantity of physical activity in overweight cases was under the official public health recommendations. These findings suggest that especially the overweight individuals should be encouraged to perform exercise.

REFERENCES

Choi, K. M., Kim, J. H., Cho, G., et al. (2007) Effect of Exercise Training on Plasma Visfatin and Eotaxin Levels. *Eur J Endocrinol*, 157, 437-42.

Chang, Y. H., Chang, D. M., Lin, K. C., et al. (2011) Visfatin in overweight/obesity, type 2 diabetes mellitus, insulin resistance, metabolic syndrome, and cardiovascular diseases: a meta-analysis and systemic review. *Diabetes Metab Res Rev*, 27, 515-27.

Dong-il, S., Wi-Young, S., Sung, H., et al. (2011) Effects of 12 weeks of combined exercise training on visfatin and metabolic syndrome factors in obese middle-aged women. *Journal of Sports Science and Medicine*, 10, 222–26.

Enevoldsen, L. H., Simonsen, L., Macdonald, I. A. et al. (2004) The combined effects of exercise and food intake on adipose tissue and splanchnic metabolism. *J Physiol*, 561, 871-82.

Fitness for Health. Tampere Finland. At: [accessed 22.04.2015] <http://www.ukkinstituutti.fi>; 2002.

Fukuhara, A., Matsuda, M., Nishizawa, M., et al. (2005) Visfatin: A Protein Secreted by Visceral Fat that Mimics the Effects of Insulin. *Science*, 307, 426-30.

Haus, J. M., Solomon, T. P., Marchetti, C. M. et al. (2009) Decreased visfatin after exercise training correlates with improved glucose tolerance. *Med Sci Sports Exerc*. 2009, 6, 1255–60.

Jurdana, M., Petelin, A., Černelič Bizjak, M., et al. (2013) Increased serum visfatin levels in obesity and its association with anthropometric/biochemical parameters, physical inactivity and nutrition. *e-SPEN Journal*, 8, 59-67.

Matinhomae, H., Banaei, J., Ali Azarbayjani, M., et al. (2014) Effects of 12-week high-intensity interval training on plasma visfatin concentration and insulin resistance in overweight men. *Journal of Exercise Science & Fitness*, 12, 20-55.

Ross, R., Dagnone, D., Jones, P. J. H., et al. (2000) Reduction in obesity and related comorbid conditions after diet-induced weight loss or exercise-induced weight loss in men. A randomized, controlled trial. *Ann Intern Med*, 133, 92–103.

Seo, D. I., So, W. Y., Ha, S. et al. (2011) Effects of 12 weeks of combined exercise training on visfatin and metabolic syndrome factors in obese middle-aged women. *J Sports Sci Med.*, 10, 222–26.

Zahorska-Markiewicz, B., Olszanecka-Glinianowicz, M., Janowska, J., et al. (2007) Serum concentration of visfatin in overweight women. *Metab Clin Exp*, 56, 1131-4.

Zerbo-Šporin, Dorjana. (2014). Waist circumference is appropriate for quantifying body fat in university female students. *Anthropological notebooks* 20(2): 145-153.

World Health Organization (2015). Global recommendations on physical activity for health. Available at:

http://www.who.int/dietphysicalactivity/factsheet_recommendations/en/

Ima li razlike u izometrijskoj izdržljivosti lumbalnih ekstenzora kod predadolescenata

Nikola Jevtić, Dragan Marinković, Dejan Javorac, Saša Semeredi, Borislav Ob-
radović

Faculty of Sport and Physical Education, University of Novi Sad, Serbia

ABSTRACT

It is a well-known fact that there is a cyclical connection between strength and endurance of lumbar extensors and that these participate in the prevention of lumbar spine problems. The aim of this study was to discover whether there are any differences between isometric endurance of lumbar extensors among children aged 11-14 (preadolescent period). In total 283 children participated in this study (148 boys and 135 girls). They were divided into separate groups based on their age. Biering-Sorensen test was used to determine isometric endurance, while ANOVA was used to determine the differences among age categories. This testing method proved that there were statistical differences between children belonging to different age groups ($F=16.248$; $p=0.000$). These data regard existing research of the strength and endurance of lumbar extensor of healthy children. This result might be useful in the process of physical education, sport training and rehabilitation.

Key Words: isometric endurance of lower back, school children, normative values

UVOD

Mišićna izdržljivost je definisana kao sposobnost izolovanog mišića ili grupe mišića da održi kontrakciju tokom određenog vremena na visokom nivou ili da ponovi kontrakciju više puta tokom vremena. Smanjena izometrijska izdržljivost lumbalnih ekstenzora je jedan od glavnih uzroka lumbalnog bola. Ova mišićna grupa je jedna od vitalnih grupa mišića koji obezbeđuju

kvalitetnu stabilizaciju lumbalnog segmenta (McGill, 2007). Snaga i izdržljivost lumbalnih ekstenzora su ciklično povezani i učestvuju u sprečavanju lumbalnih tegoba (Biering-Sørensen, 1984). Kičmeni stub je najosetljiviji na spoljašnje faktore koji mogu prouzrokovati bolove u lumbalnoj regiji leđa ili nastanak eventualnih posturalnih deformiteta (Viry i sar., 1999). Problemi smanjene izdržljivosti lumbalnih ekstenzora ne zaobilaze ni decu (Dejanovic i sar., 2012). Tokom rasta dece dolazi do slabljenja muskulature, jer često mišići ne mogu ispratiti rast kostiju, jer se morfološki razvoj koštanog sistema ne odvija u isto vreme kao i razvoj mišićne snage i izdržljivost (Dejanović i Živković, 2008). Prekomerna upotreba kompjutera i mobilnih telefona, neadekvatno dizajnirane školske klupe i stolice, fizička neaktivnost i neadekvatno fizičko vežbanje su dodatni faktori koji ostavljaju negativan trag na posturalni status i smanjenu funkciju lumbalno-abdominalne regije dece kao najosetljivijeg dela kičmenog stuba koji su u direktnoj vezi sa smanjenom izdržljivošću lumbalnih ekstenzora (McGill, 2007; Sjolie, 2001). Deca veliki deo svog vremena provode u školskim klupama, gde njihov neadekvatni položaj kičme tokom sedenja utiče na smanjenje funkcije mišića leđa i samim tim se stvara pogodno tlo za nastanak nekih od problema kičmenog stuba (Viry i sar., 1999).

Statička mišićna izdržljivost lumbalnih ekstenzora se ređe predstavlja i procenjuje od mišićne snage, iako mišićna izdržljivost može biti jednako važna, pa čak i važnija od snage kada je u pitanju prevencija lumbalnog dela kičmenog stuba (Johnson, i sar. 2009). Leđni ekstenzori su klasifikovani kao posturalni mišići, tako da je njihov zadatak da telo održavaju u uspravnom položaju i kontrolišu savijanje lumbalnog dela kičme prema napred (Calliet, 1981). Prema svom fiziološkom svojstvu u njima preovlađuju spora mišićna vlakna koja zbog svog sastava mogu da izdrže opterećenje niskog intenziteta, ali dužeg vremenskog trajanja. Kada dođe do zamora ovih mišića, pretpostavlja se da dolazi do povećanog intrasegmentalnog kretanja, što dovodi do povećanja nestabilnosti kičmenog stuba. Istraživanja su pokazala da izdržljivost i snaga tela utiču na razvoj kretanja dece, s tim što su direktno povezani sa veličinom tela, i utiče na njegove performanse. Ukoliko je ova sposobnost slabo izražena kod mišića ekstenzora leđa, moguća je pojava bola u leđima, slabije propriocepcije, ravnoteže i drugih sposobnosti. Može se reći da je stabilnost kako statička tako i dinamička pod velikim uticajem same snage lumbalnih ekstenzora koji se na taj način postavljaju kao bitan faktor u funkcionalnom definisanju leđne muskulature. Predadolescentski uzrast obuhvata period od 11 – 14 godina koji po mnogim parametrima i karakteristikama može da se označi kao kritičan u rastu i razvoju dece odnosno definisanju snage kako generalnog karaktera tako i specifičnog koji je vezan za stabilnost trupa i leđa.

Na osnovu problema koji koji se odnosi na izometrijskom izdržljivošću lumbalnih ekstenzora i posledica u slabosti, definisan je cilj da se utvrdi trend razvoja ove sposobnosti kod dece uzrasta od 11 do 14 godina i razlike između njih.

METOD

Istraživanje obuhvata zdravu mušku i žensku populaciju starosti od 11 do 14 godina (predadolescentni period). Uzorak je biran na osnovu posturalnog statusa dece, kako bi ispitanici bili ravnopravni, testiranju su pristupili ispitanici koji nisu imali lumbalnih tegoba i koji nisu imali deformitete kičmenog stuba. Testiranju je pristupilo 283 ispitanika, koji su podeljeni u 4 starosne kategorije: deca 11 godina n=79, 12 godina n=78, 13 godina n=51, 14 godina n=75. Pre testiranja je popunjen formular u kome se tražila saglasnost roditelja i potvrda Doma Zdravlja o zdravstvenom statusu dece. Istraživanje je odobreno od strane Direktora Škole i Saveta Roditelja.

Za utvrđivanje izometrijske izdržljivosti lumbalnih ekstenzora korišćen je Biering-Sorensen test (Biering-Sørensen, 1984). Na osnovu predhodnih istraživanja (Dejanovic i sar., 2012) može se konstatovati da se Sorensen test može primenjivati i kod dece mlađeg uzrasta. Grupa autora Demoulin i saradnici (2006) su u svom kritičkom osvrtu na Sorensen test na osnovu mnogobrojnih istraživanja dokazali da je test pouzdan, takođe i validan, s tim što paravertebralni mišići preuzimaju opterećenje u proseku 40%, dok ostalo opterećenje preuzimaju mišići glutealne regije i zadnje strane natkolenice.

Za utvrđivanje razlika između uzrasta, korišćen je statistički program SPSS, a primenjena je univarijatna analiza varijanse (ANOVA) i sprovedena je posthoc metoda kako bi se pojedinačno utvrdila statistički značajna razlika između svakog uzrasta posebno.

Slika 1. Varijacija Biering-Sorensen testa

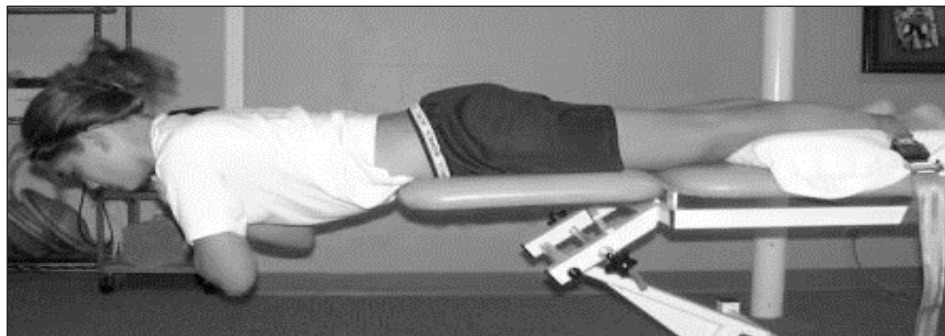

REZULTATI

Sprovedeno istraživanje sa ciljem utvrđivanja razlika i trenda koji se pojavljuje u izometrijskoj izdržljivosti lumbalnih ekstenzora različitih uzrasnih kategorija pokazuje rezultate koji su prikazani tabelarno.

Tabela 1. Osnovni deskriptivni statistici i univarijatna analiza varijanse

Uzrast (godina)	N	AS	SD	MIN	MAX
11	79	172.42	55.08	61.91	367.42
12	78	197.08	52.59	99.27	341.74
13	51	233.58	65.15	83.73	349.80
14	75	229.70	59.08	98.44	366.19
		F=17.802		sig. 0.000	

Legenda: N – Broj ispitanika; AS – aritmetička sredina; SD – standardna devijacija; MIN – minimalne vrednosti; MAX – maksimalne vrednosti; F – vrednost f testa univarijatne analize varijanse; sig. – statistička značajnost ($p \leq 0,05$)

Tabela 1 ukazuje na vrednosti deskriptivne statistike uzorka ispitanika po uzrasnim kategorijama na osnovu kojih se može uvideti da je prosečno odstupanje veoma veliko. Srednje vrednosti su u porastu sa porastom godina što predstavlja trend poboljšanja izvođenja testa koji procenjuje snagu. Najslabije rezultate u testu su postizali ispitanici starosti 11 godina dok su nabolje vrednosti posedovali ispitanici sa 13 godina starosti. Na osnovu univarijatne analize varijanse postoji statistički značajna razlika između uzrasnih kategorija ispitanika u izometrijskoj izdržljivosti lumbalnih ekstenzora ($F=17,802$; $P=0,000$).

Tabela 2. Odnosi uzrasnih kategorija u izometrijskoj izdržljivosti lumbalnih ekstenzora.

Uzrasne kategorije (godina)		Mean diff.	sig.
11	12	-24.668	0.008
	13	-61.161	0.000
	14	-57.289	0.000
12	13	-36.493	0.000
	14	-32.621 0.001	
13	14	3.872	0.711

Legenda: sig. – statistička značajnost ($p \leq 0,05$); Mean diff.- razlika u aritmetičkim sredinama

Sagledavanjem međusobnih odnosa grupa ispitanika podjeljenih na osnovu starosti može se reći da se javlja statistički značajna razlika između skoro svih parova. Jedino gde se ne uviđa takva razlika jeste između 13. i 14. godine kada se i prema prosečnim vrednostima može primetiti da je razlika minimalna i da snaga u ovom periodu stagnira. U svim drugim odnosima karakteristično je da starija grupa poseduje bolje vrednosti u izometrijskoj izdržljivosti lumbalnih ekstenzora. Najveći skok između vrednosti je primećen u uzrastu 12. i 13. godine što je evidentirano u tabeli 2.

DISKUSIJA

Ovim istraživanjem smo potvrdili hipotezu da postoje značajne razlike između uzrasnih kategorija dece od 11 do 14 godina ($p < 0.05$). Na osnovu rezultata može se reći da se mišićna izdržljivost značajno povećava od 11 do 13 godina, dok u 14. godini opada.

Takav trend može biti posledica naglog rasta i razvoja i možemo ga okarakterisati kao kritičan period za nastanak nekog od posturalnih deformiteta (Viry i sar., 1999) i lumbalnog sindroma (Johnson i sar., 2009). Pošto su karakteristike rasta i razvoja značajno povezane sa izometrijskom izdržljivošću lumbalnih ekstenzora i abdominalne muskulature kod dece od 7 do 14 godina, može se reći da je povećanje telesne težine i telesne visine utiče i na povećanje izometrijske izdržljivosti lumbalnih ekstenzora (Dejanović i Živković, 2008).

Razlike koje su se javile u izometrijskoj mišičnoj izdržljivosti između dece uzrasta od 11-14 godina mogu da se povežu sa razlikama koje se javljaju u pojedinim motoričkim sposobnostima i generalno uzrasnim karakteristikama dece. Tako u većini motoričkih sposobnosti postoje razlike u uzrastu i trend poboljšanja (Badrić i sar., 2012). Kod nekih motoričkih sposobnosti se javlja i opadanje u 14. godini što je slučaj i u ovom radu kod izometrijske izdržljivosti lumbalnih ekstenzora. Na osnovu dobijenih rezultata može se zaključiti da se trend razvoja ove sposobnosti s obzirom na uzrast odvija u skladu sa zakonitostima razvoja ostalih motoričkih sposobnosti. Zakonitosti razvoja motoričkih sposobnosti uglavnom su u skladu sa zakonitostima rasta i razvoja, što potvrđuju i istraživanja stranih autora (Badrić i sar., 2012).

Pravilnim i programiranim delovanjem na celokupan motorički prostor deteta pa i na stabilnost i trupa i leđa, moguće je doprineti boljem funkcionisanju mehanike tela što bi kao benefit imalo skladan rast i razvoj, smanjenu mogućnost nastanka deformiteta, olakšano kretanje i sl.

LITERATURA

Badrić, M., Sporiš, G., Trklja, E. i Petrović, J. (2012). Trend razvoja motoričkih sposobnosti učenika od 5. do 8. razreda. U Zbornik radova Findak, V. (ur.) 21. ljetne škole kineziologa Republike Hrvatske *Programiranje rada u području edukacije, sporta, sportske rekreacije i kineziterapije*. (115-121) Zagreb: Hrvatski kineziološki savez.

Biering-Sørensen, F. (1984). Physical measurements as risk indicators for low-back trouble over one year period. *Spine*, 9, 106-19.

Calliet, R., Low Back Pain Syndromes. 3rd ed., Philadelphia: F.A. Davis, 1981.

Dejanović, A. i Živković, D. (2008). The connection between the anthropometric characteristics of the body and the isometric endurance of the lumbar and abdominal musculature of the children. *Facta Universitatis, Series: Physical Education and Sport*, 6 (2), 85-93.

Dejanović, A., Harvey, E., McGill, S.M. (2012). Changes in 3D Torso Muscle Endurance Profiles in Children aged 7 to 14: reference values. *Archives of Physical Med and Rehab*, 93, 2295-2301.

Demoulin, C., Vanderthommen, M., Duysens, C., Crielaard, J.M. (2006). Spinal muscle evaluation using the Sorensen test: a critical appraisal of the literature. *Joint Bone Spine*. 73 (2006) 43-50.

Johnson, O.E., Mbada, C.E., Akosile, C.O., Agbeja, O.A., (2009). Isometric endurance of the back extensors in school-aged adolescents with and without low back pain. *Journal of Back and Musculoskeletal Rehabilitation*. 22(4) ,205-211.

McGill, S.M. (2007). *Low Back Disorders – 2nd Editions*. Evidence-Based Prevention and Rehabilitation. Human Kinetics USA.

Sjolie, A. N., Ljunggren, E. (2001). The significance of high lumbar mobility and low lumbar strength for current and future low back pain in adolescents. *Spine*, 26(23), 2629–2636.

Viry, P, Creveuil, C., i Marcelli, C., (1999). Nonspecific back pain in children. A search for associated factors in 14-year-old schoolchildren. *Revue du Rhumatisme English Edition*, 66, 382-388.

Differences in neuromuscular function between athletes with and without ACL re-injury – a retrospective preliminary research

Olivera Knežević¹, Marko Kadija², Darko Milovanović², Suzana Blesić¹, Dragana Drljačić³, Dragan Mirkov⁴

¹*University of Belgrade, Institute for Medical Research, Neurophysiology Lab, Serbia*

²*Institute for Orthopaedic Surgery and Traumatology, Clinical Centre of Serbia, Belgrade, Serbia*

³*Preschool Teacher Training College, Sabac, Serbia*

⁴*University of Belgrade, Faculty of Sport and Physical Education, Belgrade, Serbia*

ABSTRACT

The aim of this study was to retrospectively compare neuromuscular function of athletes who sustained a subsequent anterior cruciate ligament (ACL) graft rupture within 18 months after the reconstruction, and athletes with no subsequent re-injury in order to identify those variables that could serve as a potential injury risk indicators. Fourteen athletes (5 with and 9 without subsequent ACL re-injury) were compared prior to ACL reconstruction (ACLR) and 6 months after an ACLR. Self-reported function and knee laxity were assessed using standardized clinical tests. In addition, maximal and explosive strength of the quadriceps and hamstrings of both legs was assessed through 5 variables derived from the slope of the force-time curves over various time intervals (Fmax, RFDmax, RFD50, RFD150 and RFD250). Limb symmetry index (LSI) was calculated relative to the uninvolved leg. Although athletes with re-injury had better subjective scores at pre-ACLR than athletes without re-injury, there were no differences between the groups 6 months post-ACLR, where both groups reached normal values on self-reported scores, knee laxity and one leg hop test. LSI for quadriceps ranged from 66-93% pre-ACLR and 64-85% 6 months post-ACLR. Between group comparison indicated no difference in any of the observed LSI both pre- and 6 months post-ACLR, except for RFD50 (6

months post-ACLR). Within-group comparison revealed no significant differences among LSI calculated from Fmax and RFD variables. Hamstring's LSI was similar between the groups (all $P > 0.05$) as well as among the variables both pre-ACLR (range 79-96%) and 6 months post-ACLR (range 83-93%). The obtained data indicate that athletes with lower quadriceps explosive strength LSI may be at greater risk for re-injury or injury to contralateral limb. In addition, these findings strongly support those from recently published papers, suggesting that in addition to standard clinical evaluation and the maximal strength assessment, the indices of explosive strength should also be included in monitoring recovery of muscle function following an ACLR.

Keywords: ACL reconstruction, isometric, MVC, rate of force development, limb symmetry index

INTRODUCTION

ACLR injuries account for up to 50% of all sustained knee injuries among athletes. As most of them have the ultimate goal to return to sport at their pre-injury level, majority of them decide to undergo surgical reconstruction. Following an ACLR, an evaluation of the quadriceps and hamstrings maximum strength is of profound importance in monitoring recovery. Recent evidence suggests that in addition to maximum strength, the explosive strength could be equally important for full recovery (Angelozzi et al., 2012; Knezevic et al., 2014). Namely, maximum strength does not reflect muscle's ability to exert force in a limited amount of time, which is typical for the most of rapid, sport related movements, such as sprint running, kicking or jumping (Zebis et al., 2011).

As shown by several studies (Hsieh et al., 2014; Maffuletti et al., 2010), higher RFD and shorter time to peak force were both associated with better self-reported knee function. More importantly, maximum and explosive strength may have different rates of recovery (Angelozzi, et al., 2012; Knezevic, et al., 2014), suggesting that athletes may require longer time frames to restore acceptable levels of functional performance than currently recommended.

Recent evidence suggests that the outcome rates for return to sport and continued participation after return are lower than desired (Arden et al., 2011). Moreover, a number of studies have emphasized a rather large rates of re-injury or secondary injury to the uninvolved leg following return to high level

activity (Bien & Dubuque, 2015). Having all this in mind, we retrospectively analyzed data from recently recovered athletes (18 months after an ACLR) aiming to compare self-reported function, knee stability, maximum and explosive strength assessed prior to ACLR and 6 months after an ACLR between the athletes with a subsequent ACL re-injury and athletes with no re-injury.

METHODS

Fifteen athletes (competing at national level) were tested prior to ACLR (pre-ACLR) and 6 months post-ACLR and monitored for following 12 months. Only subjects who at the time of the first test had the first ACL injury, no other knee ligaments injured, no history of concurrent fractures, osteoarthritis, or hereditary and neuromuscular diseases were included in the study. Clinical assessment included IKDC subjective evaluation and Tegner activity scale. Knee laxity test was performed with a KT1000 instrumented arthrometer (MEDmetric Corporation, San Diego, CA) with 13.61 kg of force (Angelozzi, et al., 2012). One leg hop test (OLH) was performed only at 6 months post-ACRL. All patients received the same postoperative accelerated rehabilitation protocol.

Evaluation of the quadriceps and hamstrings maximum strength was performed with the standard isometric test based on the maximum voluntary contraction with the knee angle was fixed at 45° of flexion (0° corresponds to full extension). The uninvolved leg was tested first. Depending on the muscle group tested, subjects were instructed to extend or flex the knee “as fast and as hard as possible” (Andersen & Aagaard, 2006). Maximum strength was assessed through the maximum muscle force (F_{max}). Explosive strength was assessed through maximum (RFD_{max} - represents the maximum slope of the force-time curve (generally obtained within 100 to 140 ms from the contraction onset),) as well as contractile RFD, derived from the slope of the force-time curves at 50m, 150ms and 250ms from the onset of the contraction.

Descriptive statistics (mean and standard error) were calculated for all variables. All variables were tested separately for quadriceps and hamstrings, and separately for preACLR and postACLR measurements. Potential differences among groups were assessed using Mann-Whitney U test. Differences among variables were tested using Fridman’s ANOVA. The level of statistical significance was set to $P = 0.05$. Data were analysed using SPSS 20.0 software (SPSS Inc. Chicago, IL, USA).

RESULTS

Five out of 14 athletes who were tested 6 months post-ACLR have suffered a re-injury (4 were injured within 6 months from the assessment, and one athlete was injured 12 months later).

Table 1 shows outcomes of the clinical tests. Athletes with re-injury had better subjective scores at pre-ACLR. Six months post-ACLR both groups had the normal values of subjective scores, however the group of re-injured athletes had significantly smaller knee laxity.

Table 1. Descriptive statistics for clinical scores and one leg hop test symmetry index obtained at 6 months postACLR (all data are presented as mean ± SE).

	IKDC		Lysholm score		Activity score		Knee Laxity	
	pre-ACLR	6 months	pre-ACLR	6 months	pre-ACLR	6 months	pre-ACLR	6 months
Not re-injured	65.8±3.1	78.3±5.3	71.1±4.7	88.3±4.3	7.8±0.7	6.5±0.6	6.0±0.5	2.4±0.5
Re-injured	77.9±2.4	86.2±3.3	91.2±1.9	93.0±4.7	8.3±0.5	6.7±1.5	5.8±0.6	1.0±0.0
P value	0.008	0.234	0.008	0.492	0.839	0.923	0.998	0.048

On average, athletes without re-injury covered smaller distance with OLH (167±8.4 cm with the uninjured and 155.5±7.4 cm with the involved leg) than the athletes who later had re-injury (178.8± 10.9 cm with the uninjured leg and 167± 8.4 cm with the involved leg). Moreover, although not significantly different (P=0.062), LSI for OLH was lower for the athletes without re-injury (84.6±2.8) than for those with re-injury (95.7±3.3).

Figure 1 depicts quadriceps LSI for the maximum and explosive strength data from pre-ACLR and post-ACLR measurements. There was no difference between the groups at pre-ACLR, however, 6 months post-ACLR a significant difference was observed for RFD 0-50ms (P< 0.05). Difference in size of LSI among the tested variables was not significant both pre-ACLR (range 66-93%) and 6 months post-ACLR (range 64-85%).

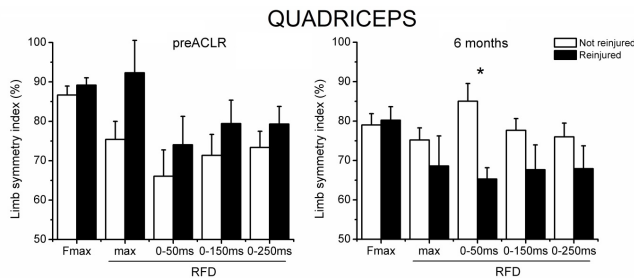

Figure 1. Comparison of limb symmetry index between the groups for quadriceps' maximum strength and indices of explosive strength (data presented as Mean ± SE). * indicates to significant difference at P< 0.05.

PHYSICAL ACTIVITY FOR HEALTH
KINEZIOLŠKA AKTIVNOST ZA ZDRAVLJE

Hamstring's LSI data from pre-ACLR and post-ACLR measurements are presented in Figure 2. The size of LSI was similar between the groups (all $P > 0.05$) as well as among the variables both pre-ACLR (range 79-96%) and 6 months post-ACLR (range 83-93%).

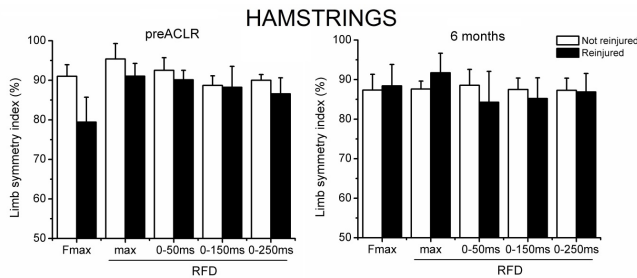

Figure 2. Comparison of limb symmetry index between the groups for hamstrings' maximum strength and indices of explosive strength (data presented as Mean \pm SE).

DISCUSSION AND CONCLUSIONS

The aim of this study was to compare self-reported function, knee stability and neuromuscular function between athletes who sustained a subsequent ACL re-injury within 18 months after the reconstruction, and athletes with no subsequent injury in order to identify those variables that could serve as a potential injury risk indicators. Although self-reported scores, clinical test and maximum strength suggested to sufficiently recovered function at 6 months post-ACLR, the athletes who suffered re-injury had pronounced asymmetry in quadriceps' explosive strength.

The results of the current study indicate to rather high rate of re-injury following return to sport (30%). At 6 months post-ACLR the athletes who were re-injured had better scores on all tests, except in indices of the explosive strength (particularly in the early phase from the contraction onset). Although quadriceps weakness and deficits in postural stability, lower extremity mechanics and psychological preparedness (Bien & Dubuque, 2015) are often observed in the first 6 months of recovery following ACLR, the findings from this study indicate that deficits in the neurophysiological mechanisms (such as loss of afferent feedback and impaired voluntary activation could be particularly pronounced (Konishi et al., 2011; Lepley et al., 2014) and may present a risk factor for re-injury.

Despite recent advances in ACL reconstruction approach and progressive rehabilitation protocols, deficits in muscle's ability to exert force in a limited

amount of time persist after completion of the rehabilitation, indicating that athletes with lower quadriceps explosive strength LSI may be at greater risk for re-injury or injury to contralateral limb. This further suggests that athletes may require longer time frames to restore acceptable levels of functional performance than currently recommended. These results may also suggest shortcomings in commonly utilized return to sport testing criteria and that in addition to standard clinical evaluation and the maximal strength assessment, the indices of explosive strength should also be included in monitoring recovery of muscle function following an ACLR.

ACKNOWLEDGEMENTS

Support for this study was provided by Ministry of Education, Science and Technological Development of Republic of Serbia (#175037; #175012 and #171015).

REFERENCES

Andersen, L. L., & Aagaard, P. (2006). Influence of maximal muscle strength and intrinsic muscle contractile properties on contractile rate of force development. *Eur J Appl Physiol*, 96(1), 46-52.

Angelozzi, M., Madama, M., Corsica, C., Calvisi, V., Properzi, G., McCaw, S. T., & Cacchio, A. (2012). Rate of Force Development as an Adjunctive Outcome Measure for Return-to-Sport Decisions After Anterior Cruciate Ligament Reconstruction. *J Orthop Sports Phys Ther*, 42(9), 772-780.

Ardern, C., Webster, K., Taylor, N., & Feller, J. (2011). Return to sport following anterior cruciate ligament reconstruction surgery: a systematic review and meta-analysis of the state of play. *Brit J Sport Med*, 45(7), 596.

Bien, D. P., & Dubuque, T. J. (2015). Considerations for late stage acl rehabilitation and return to sport to limit re-injury risk and maximize athletic performance. *Int J Sports Phys Ther*, 10(2), 256-271.

Hsieh, C. J., Indelicato, P. A., Moser, M. W., Vandenborne, K., & Chmielewski, T. L. (2014). Speed, not magnitude, of knee extensor torque production is associated with self-reported knee function early after anterior cruciate ligament reconstruction. *Knee Surg Sports Traumatol Arthrosc*. doi: 10.1007/s00167-014-3168-1

Knezevic, O. M., Mirkov, D. M., Kadija, M., Nedeljkovic, A., & Jaric, S. (2014). Asymmetries in explosive strength following anterior cruciate ligament reconstruction. *Knee*. doi: S0968-0160(14)00166-5 [pii] 10.1016/j.knee.2014.07.021

Konishi, Y., Oda, T., Tsukazaki, S., Kinugasa, R., Hirose, N., & Fukubayashi, T. (2011). Relationship between quadriceps femoris muscle volume and muscle torque after anterior cruciate ligament rupture. *Knee Surg Sports Traumatol Arthrosc*, 19(4), 641-645. doi: 10.1007/s00167-010-1324-9

Lepley, A. S., Ericksen, H. M., Sohn, D. H., & Pietrosimone, B. G. (2014). Contributions of neural excitability and voluntary activation to quadriceps muscle strength following anterior cruciate ligament reconstruction. *Knee*, 21(3), 736-742.

Maffiuletti, N. A., Bizzini, M., Widler, K., & Munzinger, U. (2010). Asymmetry in quadriceps rate of force development as a functional outcome measure in TKA. *Clin Orthop Relat Res*, 468(1), 191-198.

Zebis, M. K., Andersen, L. L., Ellingsgaard, H., & Aagaard, P. (2011). Rapid hamstring/quadriceps force capacity in male vs. female elite soccer players. *J Strength Cond Res*, 25(7), 1989-1993.

Razlike u posturalnom statusu kolena devojčica uzrasta od 4 do 13 godina

Branka Protić - Gava, Mario Roška, Tijana Šćepanović

Fakultet sporta i fizičkog vaspitanja, Univerzitet u Novom Sadu, Novi Sad, Srbija

ABSTRACT

For the total sample of 455 female respondents, aged 7.60 ± 2.10 years (BH = 128.38 ± 14.57 cm; BM = 28.57 ± 9.64 kg) from the territory of Srem (Serbia), we conducted a transversel research in order to determine the differences in postural status of the knee between the age groups of 4-13 years. The testing was carried out within the international IPA project, "Improving posture status and the status of the spine" - SPINELAB, in Serbia and Bosnia and Herzegovina (Grant Contract 2013 / 323-164), whose implementer was the Faculty of Sport and Physical Education, University of Novi Sad. The testing was measured by fotometric Contemplas Templo 3D analysis of postural status with 16 markings on the body, filmed from three calibrated cameras. By applying Multivariate analysis of variance the results indicate that there is a statistically significant difference in the status of the legs between the age group of women. In our study, we found that the most common phenomenon was "X" leg. Univariate analysis of variance shows that there are differences in the status between the legs of the respondents classified by age categories with the fact that the only statistically significant difference was recorded in the parameter knee flexion of the right leg ($p = 0.009$). The research results points out the need for action in order to form a proper posture of children during the early period of growth and development.

Keywords: Postural deformities of the legs, girls, Contemplas

UVOD

Posturalni poremećaji donjih ekstremiteta, koji se javljaju kao angularni poremećaji zgloba kolena, učestala su pojava kod dece i mladih (Protić - Gava,

Krneta, Romanov, 2011; Joo et al., 2007). To su varus i valgus položaji ("O" i "X" noge), te hiperekstenzija kolena, koji mogu da predstavljaju veliki zdravstveni, ali i socijalni problem. Ovi poremećaji mogu nastati spontano, u toku rasta i razvoja. Takođe, mogu biti posledica lokalnih ili opštih oboljenja, ili se javiti kasnije tokom života, kao posledica oslabljene muskulature usled hipokinezije ili gojaznosti te kao posledica zanimanja ili zaostalih povreda. Kod dece mlađeg školskog uzrasta, ovi poremećaji su najčešće uzrokovani oslabljenom muskulaturom usled neaktivnosti.

Donji ekstremiteti igraju veliku ulogu u pravilnom funkcionisanju lokomotornog aparata. Specifična struktura građe kolena uslovljava ograničenu pokretljivost na samo nekoliko pokreta - fleksiju, ekstenziju i minimalnu rotaciju. Slabost određene mišićne grupe prednje, zadnje ili bočnih strana, dovodi do navedenih posturalnih poremećaja. Ovi poremećaji su sve češći kod dece mlađeg školskog uzrasta i pored njihovog odstupanja u frontalnoj ravni, najčešće su povezani pokretom fleksije ili ekstenzije, što dodatno pogoršava stanje.

Veliki broj istraživanja potvrđuje učestalost ovih posturalnih poremećaja (Purenovic, 2007; Penha et al., 2005; Joo et al., 2007; Protić - Gava i sar., 2009; Protić - Gava, Krneta i Romanov, 2011), ne samo u populaciji dece koja se ne bave sportom, već i kod sportista (Ribeiro et al., 2003; Krneta, Protić - Gava, Vuković, Šćepanović, 2012), ali uzrok može biti i endemske prirode (Chakma et al., 2000).

Ovo istraživanje sprovedeno je u okviru međunarodnog IPA projekta prekogranične saradnje, pod nazivom "Unapređenje procene posturalnog statusa i statusa kičme - SPINELAB" ("Improving testing abilities on postural and spinal column status / SPINELAB" Grant Contract 2013/323-164), na području Srbije (Srem) i Bosne i Hercegovine (kanton Sarajevo). Istraživanje je realizovao Fakultet sporta i fizičkog vaspitanja Univerziteta u Novom Sadu, kao nosilac projekta u saradnji sa Fakultetom sporta i tjelesnog odgoja Univerziteta u Sarajevu, kao partnerom. Implementacija projekta trajala je od 20. avgusta 2013. do 20. novembra 2014. godine. Generalni cilj projekta bio je unapređenje detekcije i prevencije posturalnih poremećaja, zdravstvenih problema senzomotornog aparata dece dva navedena regiona.

Polazeći od pretpostavke da su posturalni poremećaji donjih ekstremiteta dece predškolskog i mlađeg školskog uzrasta učestali, cilj ovog rada bio je da se utvrdi posturalni status kolena devojčica uzrasta od 4 do 13 godina, te eventualne razlike u odnosu na periode rasta i razvoja: predškolski uzrast, period polaska u školu te period ulaska u pubertet.

METOD

Istraživanjem je obuhvaćeno 455 ispitanica ženskog pola, uzrasta od 4 do 13,5 godina (srednja vrednost uzrasta $7,60 \pm 2,10$ godina, $TV=128,38 \pm 14,57$ cm i $TM=28,57 \pm 9,64$ kg), čiji su roditelji dali saglasnost za učešće njihove dece u istraživanju. Ispitanice su podeljene u četiri subuzorka u odnosu na uzrast: od 4 do 5,9 godina (predškolski uzrast), perioda polaska u školu (od 6 do 6,8 godina), mlađi školski uzrast od 6,9 do 9,2 godine i period ulaska u pubertet, od 9,3 do 13,5 godina.

Posturalni status utvrđen je primenom savremene, fotometrijske, neinvazivne aparature CONTEMPLAS GmbH TEMPLO, koja podrazumeva markiranje referentnih tačaka u prostoru, sistem kamera kojim se utvrđuje pozicija markiranih tačaka i softversku analizu. Korišćena je 3D analiza za procenu držanja tela, u kojoj su korišćene retroreflektivne markirne loptice koje daju mogućnost najpreciznijeg merenja posturalnog statusa i statusa nogu. Za utvrđivanje posturalnog statusa kolena, ova metoda procenjuje poziciju 6 tačaka u kalibrisanom prostoru: trochanter major (levi i desni); malleolus lateralis (levi i desni); condylus lateralis (levi i desni). Ispitivanjem dva parametra koji označavaju postojanje fleksije/ekstenzije, odnosno pojave varus/valgus deformiteta, kako za desnu tako i za levu nogu, softverskom analizom utvrđen je status nogu i eventualno odstupanje od fiziološkog - postojanje "X" ili "O" nogu.

Dobijeni podaci analizirani su primenom Multivarijatne analize varijanse (MANOVA) u cilju utvrđivanja razlika između uzrasnih kategorija u statusu nogu na generalnom nivou. Univarijatnom analizom varijanse (ANOVA) izvršena je procena razlika u statusu nogu zasebno po parametrima. Analiza je urađena na nivou značajnosti $p \leq 0.05$. Statistička procedura sprovedena je u softverskom paketu SPSS for Windows, verzija 20.0.

REZULTATI

Posturalni poremećaji donjih ekstremiteta, položaji valgus i varus, te fleksija i ekstenzija kolena, prikazuju se u softverskoj analizi Contemplasa kao rezultati sa pozitivnim i negativnim predznakom, koji mogu da se kreću u normalnim granicama do vrednosti 3, koja već označava posturalni poremećaj blažeg oblika. Što su veće vrednosti od 3, bilo u plusu ili minusu, to je i veći posturalni poremećaj kolena. Valgus i varus položaji odnose se na ugao zgloba kolena koji zaklapaju natkolenica i potkolenica, koji se javlja u frontalnoj ravni. U sagitalnoj ravni, javljaju se fleksija i ekstenzija kolena. Valgus položaj i ekstenzija zgloba kolena prikazuju se u plus, a varus položaj i fleksija kolena u minus vrednostima.

U Tabeli 1 prikazane su razlike u statusu nogu ukupnog uzorka ispitanica u odnosu na uzrasnu kategoriju. Vrednosti Multivarijantne analize varijanse ukazuju na to da na celokupnom sistemu parametara, između uzrasnih grupa ispitanica, postoji statistički značajna razlika u statusu nogu. U ispitivanom uzorku postoji tendencija učestalije pojave "X" nogu, kao i fleksija kolena. Univarijantna analiza varijanse pokazuje razlike u statusu nogu između ispitanica svrstanih po uzrasnim kategorijama. Jedina statistički značajna razlika evidentirana je u parametru fleksija desne noge ($p=0.009$). U ostalim ispitivanim parametrima nije utvrđena statistički značajna razlika.

Interesantno je analizirati trend povećanja valgus položaja u različitim uzrasnim kategorijama. Naime, valgus položaj leve noge ima tendenciju povećanja od četvrte do 9,2 godine, a opada u uzrastu od 9,3 do 13,5 godina. U uzrastu od 6,0 do 6,8 godina, uočava se smanjenje valgus položaja desne noge, nakon čega sledi povećanje valgusa u obe naredne uzrasne kategorije. Ispitanice uzrasta od 9,3 do 13,5 godina imaju najveći valgus položaj desne noge, ali je i ovaj rezultat ispod vrednosti koja označava posturalni poremećaj. Fleksija kolena leve i desne noge najveća je kod ispitanica uzrasta od 6,9 do 9,2 godine.

Tabela 1. Razlike u statusu nogu ukupnog uzorka ispitanica u odnosu na uzrast

Parametar kolena	Kategorije uzrasta	N	As	Sd	f	p
Valgus/Varus položaj leve noge	4,0-5,9	92	1,348	2,726	1,140	0,332
	6,0-6,8	104	1,501	2,357		
	6,9-9,2	98	1,954	2,701		
	9,3-13,5	122	1,834	2,724		
Valgus/Varus položaj desne noge	4,0-5,9	92	1,563	2,644	2,000	0,113
	6,0-6,8	104	1,439	2,779		
	6,9-9,2	98	1,725	2,802		
	9,3-13,5	122	2,256	2,652		
Flexia/Extensia leve noge	4,0-5,9	92	-4,045	8,394	1,229	0,299
	6,0-6,8	104	-5,251	8,359		
	6,9-9,2	98	-6,245	7,145		
	9,3-13,5	122	-5,744	9,050		
Flexia/Extensia desne noge	4,0-5,9	92	-1,529	8,904	3,916	0,009
	6,0-6,8	104	-2,466	8,360		
	6,9-9,2	98	-5,576	8,419		
	9,3-13,5	122	-2,966	8,752		
		F=3,464	P=0,000			

Legenda: N- broj ispitanika; As- prosečna vrednost; Sd- standardna devijacija; f- vrednost f testa; p statistička značajnost; F- vrednost multivarijantne analize varijanse; P- statistička značajnost.

DISKUSIJA I ZAKLJUČAK

Ugao između anatomske ose butne kosti i potkolenice, menja se hronološki tokom rasta i razvoja, kroz tri faze. Prva faza, tokom koje dolazi do promena poravnanja kolena od infantilnog fiziološkog varusa do maksimalnog valgusa je period od 0. do 4. godine (Yoo et al., 2008). U drugoj fazi između 5. i 8. godine, smanjuje se valgus kolena dok u trećoj fazi, od 9. do 15. godine, poravnanje kolena ostaje nepokretno. Rezultati našeg istraživanja upravo se podudaraju sa istraživanjem Joa i saradnika (Yoo et al., 2008), ali samo kada je u pitanju valgus dese noge. Primena pouzdane, neinvazivne metode za procenu posturalnog statusa nogu, npr. Contemplasa, može doprineti relevantnom i dobrom razumevanju razvoja ugla kolena kod dece tokom rasta i razvoja. Na taj način može se sprečiti izlaganje dece nepotrebnom dijagnostičkom merenju kao što je ponovljena radijacija, ili upotreba neprikladnih ortoza koje nekada mogu biti i smetnja pravilnom razvoju dece (Yoo et al., 2008).

Rezultati našeg istraživanja koji ukazuju na učestaliju tendenciju pojave genu valgum ("X" noge), ne podudaraju se sa rezultatima istraživanja Eharija i saradnika (Echarri et al., 2008), koji su ustanovili veću učestalost genu varum (58,2%) u odnosu na genu valgum (13,9%) u ispitivanoj populaciji dece. Verovatno je ova razlika nastala zbog uzorka ispitanika, koji u našem istraživanju predstavljaju samo ispitanike ženskog pola. Takođe, ustanovili su da genu varum statistički značajno preovladava kod ispitanica uzrasta od 2 do 4 godine. Naše istraživanje pokazuje da je tendencija genu valgum izraženija u ispitivanoj populaciji u našem radu.

Izražena fleksija oba kolena u ukupnom uzorku ispitanika ukazuje pre svega na skraćenu muskulaturu zadnje strane nogu, te pojavu posturalnih poremećaja kičmenog stuba u sagitalnoj ravni. Kada je u pitanju jednostrana fleksija kolena, povezana sa unutrašnjom rotacijom zgloba kuka i kompenzatornom rotacijom kičmenog stuba u suprotnu stranu, ukazuje na poremećaje kičmenog stuba u frontalnoj ravni.

Rezultati našeg istraživanja koji pokazuju da je valgus položaj desne noge kod ispitanica uzrasta od 4. do 5,9 godine, manji u odnosu na grupu ispitanica uzrasta od 6,0 do 6,8 godina, ne podudara se sa rezultatima istraživanja Yoo i saradnika (2008), koji pokazuju da je pik valgus položaja kolena upravo kod ispitanika uzrasta 4 godine. U našem istraživanju, pik valgusa desne noge je u najstarijoj uzrasnoj kategoriji, koja se podudara sa kritičnim periodom ulaska u pubertet, gde dolazi do učestale pojave posturalnih poremećaja usled naglog rasta i razvoja.

Sagledavajući rezultate našeg i istraživanja drugih autora, moramo ukazati na potrebu pravovremenog delovanja u cilju formiranja pravilnog držanja tela dece tokom ranog perioda rasta i razvoja. Pored niza drugih faktora, rano uključivanje dece u elementarne oblike kretanja (puzanje, hodanje, penjanje, trčanje, skokovi u dubinu, provlačenje, pomicanje u uporu, višenje, okretanje oko uzdužne ose tela, te obrtanje oko poprečne ose), zavisi najviše od angažovanja roditelja, vaspitača, učitelja i profesora fizičkog vaspitanja i sporta koji igraju vrlo važnu ulogu u pravilnom i zdravom odrastanju dece bez posturalnih poremećaja.

Literatura

Chakma, T., Vinay Rao, P., Singh, S., B., Tiwary, R., S. (2000). Endemic Ganu Valgum and other bone deformities in two villages of Mandla District in Central India. *Fluoride*, 33(4), 187-195.

Echarri, J., J., Aimé Bezeboso, J., Guillén-Grima, F. (2008). Rachitic deformities of lower members in congolese children. *An. Sist. Sanit. Navar*, 31(3), 235-240.

Joo, S., Y., Park, W., H., Park, B., K., Kim, B., S., Park, J., S., Kim, H., W. (2007). A New Classification for Idiopathic Genu Vara. *Yonsei Med J*, 48(5), 833-838.

Krneta, Ž., Protić - Gava, B., Vuković, M., Šćepanović, T. (2012). A comparative analysis of the postural status of young female girls volleyball players from Vojvodina and their peers. *Fakta Universitatis. Series: Physical Education and Sport*, 10(4), Special Issue, 311-318.

Penha, P., J., Joao, S., M., A., Casarotto, R., A., Amino, C., J. & Penteadó, D., C. (2005). Postural assessment of girls between seven and ten years of age. *Clinics*, 60(1), 9-16.

Pinto Ribeiro, C.Z., Hanai Akashi, P.M., Camargo Neves, S.I. & Pedrinelli, A. (2003). Relationship between postural changes and injuries of the locomotor system in indoor soccer athletes. *Revista Brasileira de Medicina do Esporte*, 9(2), 98-103.

Protić - Gava, B., Bošković, K., Krsmanović, T., Romanov, R. (2009). The relationship between pelvis posture and lower extremities in young schoolchildren. U M. Mikalački (Ur.), *Proceedings of the 1st International Scientific Conference "Exercise and Quality of life"* (str. 447-452). Novi Sad: Faculty of Sport and Physical Education, University of Novi Sad.

Protić - Gava, B., Krneta, Ž., Romanov, R. (2011). Razlike u posturalnim poremećajima donjih ekstremiteta kod adolescenata grupisanih prema morfološkim karakteristikama. *Glasnik Antropološkog društva Srbije*, 46, 401-406.

Purenović, T. Review of national and international research studies in postural deformities: the period from 2000 to 2007. (2007). *Physical Education and Sport*, 5(2), 139 – 152.

Yoo, J., H., Choi, I., H., Cho, T., J., Chung, Y., C. & Yoo, W., J. (2008). Development of Tibiofemural Angle in Korean Children. *J Korean Med Sci*, 23, 714-717. DOI: 10.3346/jkms.2008.23.4.714

Posturalni status kičmenog stuba kod dečaka uzrasta od 4-13 godina

Darinka Korovljević, Dragan Marinković, Mario Roška, Dejan Madić

Fakultet sporta i fizičkog vaspitanja, Univerzitet u Novom Sadu, Novi Sad, Srbija

ABSTRACT

For the total sample of 510 respondents from the territory of Srem (Serbia), (7.44 ± 2.01 years) a transversal research was conducted with the aim of determining the differences in postural status of the spine between the age groups of boys 4-13 years. The survey was conducted within the international IPA project entitled "Improving posture status and the status of the spine" - SPINELAB, in Serbia and Bosnia and Herzegovina. Postural status of the spine was estimated by using the photometric method CONTEMPLAS GmbH TEMPLO. Multivariate analysis of variance on the total sample of respondents found statistically significant difference ($P = 0.000$) in all observed indicators for assessment of the postural status of the spine. Univariate analysis of variance showed statistically significant differences between the groups of respondents in estimating the value of thoracic kyphosis and lumbar lordosis, and the oldest respondents had greater variation when compared to the younger categories, while in the other investigated parameters of postural status of the spine, no statistically significant differences were found.

Keywords: growing and development, postural spine status, boys

UVOD

Ontogenetske transformacije antropološkog prostora kod osoba muškog pola neminovne su i prirodne u skladu sa zakonitostima koje sa sobom nose sam proces onotogeneze. Međutim, na osnovu nekih dosadašnjih istraživanja, primećuje se fenomen biološke akceleracije u poslednjem veku. Ova pojava odnosi se na proces ubrzanog sazrevanja dece u odnosu na ranije generacije.

Ovaj fenomen nije u potpunosti objašnjen ali se donekle može pojasniti poboljšanjem uslova života i ishrane, kao i promenom drugih elemenata životnog stila (Pantelić i sar., 2010). Ova pojava nosi sa sobom neke promene u prirastu visine i mase tela kod dečaka i reflektuje se na ukupan rast i razvoj. Fenomen telesnog razvoja je usko vezan sa fenomenom telesnog rasta i podrazumeva niz različitih promena i procesa koje vode ka ukupnom sazrevanju. Ova dva pojma je teško podeliti jer se međusobno nadopunjuju, ali se sve češće danas pod rastom podrazumevaju anatomske i funkcionalne promene veličine i oblika tela, a pod razvojem sveukupno postepeno sazrevanje kroz procese koji vode ka ukupnom kvalitativnom sazrevanju (Mišigoj-Duraković, 2006; Bala, Jakšić i Popović, 2009). Rast deteta u visinu i porast telesne mase kao najmarkantnijih pokazatelja fizičkog rasta, ne idu uporedo. Rast u visinu najviše se odvija na račun rasta koštanog tkiva (ekstremiteti i kičmeni stub), dok je rast u širinu i porast telesne mase posledica delom rasta koštanog tkiva, delom rasta nervnog, respiratornog, mišićnog sistema.

Kao posledica biološke akceleracije, promene životnog stila i nesrazmernog rasta i razvoja, zastupljenost posturalnih poremećaja kod dece iz godine u godinu postaje sve češća pojava. Dobar posturalni status odnosno pravilno držanje tela može se još definisati kao stanje dobrog mišićno - skeletnog balansa koji štiti od nastajanja i progresivnog razvoja posturalnih poremećaja onih struktura koje drže telo u uspravnom stavu ili nekom drugom položaju, bilo u kretanju ili pri mirovanju (Madić, 2014). Sa druge strane sve prisutnije dugotrajno i nepravilno sedenje kod dece, smanjena fizička aktivnost, energetski neuravnotežene ishrana, predstavljaju samo neke od činjenica koji govore da gotovo ne postoji dete kod kojeg ne možemo uočiti povećanje krivine kičmenog stuba, bilo u frontalnoj ili sagitalnoj ravni, kao posledicu navedenih loših svakodnevnih navika. Istraživanje koje je nedavno sprovedeno, pokazuje, da 30% dece školskog i predškolskog uzrasta ima nepravilno držanje tela (Kojić, 2014). Takođe, istraživanja koja su sprovedena na uzorku školske dece, od 7 do 10 godina, potvrđuju da procentualna vrednost deformiteta kičmenog stuba u frontalnoj i sagitalnoj ravni, linearno raste sa uzrastom dece (Milenković i sar., 2003; Penha i sar., 2005). Ovaj problem iz godine u godinu postaje sve veći, što potvrđuju istraživanja koja su se bavila oviom temom (Milenković, Kocijančić i Belojević, 2004; Bogdanović, 2005; Purenović, 2006).

Problem ovog rada predstavlja analiza posturalnog statusa kičmenog stuba u frontalnoj i sagitalnoj ravni kod dečaka predškolskog i školskog uzrasta sa teritorije Srema, Srbija. Cilj rada bio je utvrditi da li postoje razlike u postural-

nom statusu kičmenog stuba kod dečaka različitih uzrasnih kategorija, kao i kakve su te razlike u odnosu na njihovu starosnu dob.

METOD

Istraživanjem bilo je obuhvaćeno 510 ispitanika muškog pola, uzrasta $7,44 \pm 2,01$ godina ($TV=127,52 \pm 13,05$ cm; $TM=28,11 \pm 9,24$ kg). Testiranje je bilo realizovano okviru međunarodnog IPA projekta pod nazivom „Unapređenje posturalnog statusa i statusa kičme – SPINELAB“, na području Srbije i Bosne i Hercegovine (“Improving testing abilities on postural and spinal column status / SPINELAB” Grant Contract 2013/323-164). Testiranja su vršena u predškolskim i školskim ustanovama Indije, Rume, Stare Pazove i Sremske Mitrovice. Posturalni status kičmenog stuba porcenjen je primenom savremene fotometrijske aparature CONTEMPLAS GmbH TEMPLO koja podrazumeva sistem kamera i softversku analizu sa kojom se utvrđuje pozicija markiranih tačaka u prostoru prema 3D Posture Analysis protokolu. Ovaj metod predstavlja najsavremeniji način merenja posturalnog statusa analizirajući sve potrebne delove i ose tela na precizan i jednostavan način. 3D analize su analize za procenu posturalnog statusa koje podrazumevaju tri kamere pomoću kojih se postura tela sinhronizovano snima i analizira u tri perspektive istovremeno. Prilikom analize su se koristile reflektujuće markirne loptice koje daju mogućnost najpreciznijeg merenja posturalnog statusa ljudskoga tela neinvazivnom metodom. Ovom metodom precizno merimo držanje tela, asimetrično stajanje, povećane rotacije u ramenima i kukovima, ose nogu i držanje tela gledano sa strane. Automatskim, čekiranjem markiranih fiksnih tačaka na skeletu, softver meri i računa držanje tela. U proceduri testiranja, merioci su postavljali 16 reflektujućih markera na sledeće tačke na telu:

Markeri za procenu statusa kičmenog stuba u frontalnoj ravni:

- Vratna skolioza – markirana pozicija sedmog vratnog pršljena u odnosu na osu koja prolazi vertikalno kroz sacrum u frontalnoj ravni;
- Grudna skolioza – markirana pozicija najisturenijeg pršljena grudne krivine u frontalnoj ravni
- Slabinska skolioza – markirana najudubljeniji pršljen slabinske krivine u frontalnoj ravni

Markeri za procenu statusa kičmenog stuba u sagitalnoj ravni:

- Vratna lordoza - markirana pozicija sedmog vratnog pršljena u odnosu na osu koja prolazi vertikalno kroz sacrum u sagitalnoj ravni;

- Grudna kifoza - markirana pozicija najjisturenijeg pršljena grudne krivine u sagitalnoj ravni

- Slabinska lordoza – markirana pozicija najudubljenijeg pršljena slbinske krivine u sagitalnoj ravni

Nakon toga, protokolom je predviđeno postavljanje ispitanika u kalibri-sani prostor te realizacija fotometrijskog snimanja pomoću tri kamere (Basler acA645-100gm/gc). Dobijeni rezultati su potom obrađeni u softveru Templo 7.0 i utvrđeni su parametri koji određuju posturalni status kičmenog stuba posmatranog uzorka.

Za dobijanje potrebnih informacija o antropometrijskim merama procedura testiranja je sprovedena u skladu sa IBP (Internacionalnom Biološkom Program) standardima upotrebom antropometra po Martinu i decimalne vage. Uzorak antropometrijskih mera bio je sledeći:

- za procenu longitudinalne dimenzionalnosti tela – visina tela (cm)
- za procenu telesne težine (0,1kg)

Ukupan uzorak ispitanika raspoređen je u uzrasne grupe, nakon čega su formirani odgovarajući subuzorci ispitanika u odnosu na izračunatu decimalnu starost pri čemu su uzeti u obzir datumi rođenja i testiranja: grupa 1 (N=65) uzrasta od 4-5,9 godina; grupa 2 (N=142) uzrasta 6,0-6,8 godina; grupa 3 (N=134) uzrasta 6,9-9,2 godina; grupa 4 (N=114) uzrasta 9,3-13,5 godina. Statistička analiza dobijenih podataka je sprovedena je primenom Multivarijatne analize varijanse (MANOVA) za procenu razlika na celokupnom sistemu uzorkovanih varijabli između uzrasnih grupa. Univarijatnom analizom varijanse (ANOVA) utvrđena je razlika u pojedinačnim varijablama posturalnog statusa između uzrasnih kategorija dečaka. Kako bi se uvidela razlika između parova grupa primenjena je LSD post hoc analiza. Celokupna statistička analiza vršena je u softverskom paketu SPSS 20.0.

REZULTATI

Osnovne karakteristike uzorka ispitanika su prikazane u Tabeli 1. i ukazuju na to da je raspodela u svim varijablama, sagledavanjem standardne devijacije, normalna. Dakle većih odstupanja nema i mogli bismo reći da uzorak ispitanika pripada normalnoj populaciji.

Tabela 1. Osnovni deskriptivni statistici celokupnog uzorka dečaka

Varijabla	Min	Max	As	Sd
Decimalna starost ispitanika	3,99	13,72	7,4425	2,01544
Telesna visina	103,1	160,6	127,523	13,0528
Telesna masa	14,7	59,7	28,110	9,2403
Vratna lordoza	-8,57	5,22	0,9590	2,56099
Grudna kifoza	-3,55	2,14	-1,4005	1,12572
Slabinska lordoza	-2,28	5,48	1,1702	1,26822
Vratna skolioza	-4,92	3,00	-0,2021	0,98564
Grudna skolioza	-2,14	1,42	-0,4023	0,72757
Slabinska skolioza	-1,03	1,00	-0,1789	0,32055

Legenda: N-broj ispitanika; Min-minimalne vrednosti; Max- maksimalne vrednosti; As- aritmetička sredina; Sd- standardna devijacija

U Tabeli 2. prikazani su rezultati multivarijatne analiza varijanse koji ukazuju na statistički značajne razlike celokupnog sistema varijabli posturalnog statusa kičmenog stuba između uzrasnih grupa ispitanika i to na nivou statističke značajnosti ($P=0,00$).

Rezultati univarijatne analize varijanse (Tabela 2) pokazali su statistički značajne razlike između pojedinačnih varijabli Grudna kifoza i Slabinska lordoza kod dečaka različitih uzrasnih kategorija. Statistička značajnost izostala je za sve preostale varijable koje procenjuju posturalni status kičmenog stuba kako u sagitalnoj tako i u frontalnoj ravni. Analizom razlika u aritmetičkim sredinama između grupa ispitanika, opaža se porast vrednosti kod svih varijabli sa uzrastom. Testirana značajnost razlika po parovima grupa za svaku pojedinačnu varijablu prikazana u Tabeli 2. govori u prilog tome da je samo u dve varijable (Grudna kifoza i Slabinska lordoza) ustanovljena statistička značajnost ($p=0,000$) između grupa ispitanika. U varijabli Grudna kifoza statistički značajna razlika ($p=0,000$) između grupa pojavila se kod ispitanika koji pripadaju grupama 2 i 3 odnosno grupama 3 i 4. Kod varijable Slabinska lordoza, statistički značajna razlika uviđa se između ispitanika koji pripadaju grupama 1 i 3, 1 i 4, 2 i 3 i 2 i 4, prilikom čega je utvrđeno da je ta razlika na nivou od $p=0,000$. Sagledavanje rezultata u Tabeli 2. takođe možemo uvideti da u ostalim varijablama nije utvrđena statistička značajna razlika po parovima grupa ispitanika.

Sagledavanjem svih varijabli koje procenjuju status kičmenog stuba u sagitalnoj ravni, razlika između srednjih vrednosti je takva da starije grupe ispitanika poseduju veće vrednosti i otuda negativan predznak u odnosima grupa ispitanika.

Varijable koje procenjuju status kičmenog stuba u frontalnoj ravni sa druge strane ukazuju da je razlika srednjih vrednosti grupa ispitanika takva da starije grupe poseduju manje vrednosti ali zbog inverzne metrike ovakvi rezultati takođe ukazuju na pogoršanje stanja sa uzrastom.

Tabela 2. Statistička značajnost razlika u varijablama koje procenjuju posturalni status kičmenog stuba između uzrasnih kategorija dečaka.

Varijabla	Grupa (I)	Grupa (II)	Md	p	f	p
Vratna lordoza (cm)	1	2	0,182	0,607	0,610	0,609
		3	-0,024	0,943		
		4	-0,259	0,492		
	2	3	-0,158	0,587		
		4	-0,442	0,178		
		3	4	-0,284		
Grudna kifoza	1	2	0,170	0,269	6,291	0,000
		3	-0,113	0,450		
		4	-0,400	0,015		
	2	3	-0,057	0,649		
		4	-0,570	0,000		
		3	4	-0,513		
Slabinska lordoza (cm)	1	2	-0,135	0,428	12,971	0,000
		3	-0,743	0,000		
		4	-0,807	0,000		
	2	3	-0,608	0,000		
		4	-0,672	0,000		
		3	4	-0,064		
Vratna skolioza (cm)	1	2	-0,045	0,730	2,065	0,104
		3	0,201	0,116		
		4	0,135	0,334		
	2	3	0,247	0,022		
		4	0,180	0,138		
		3	4	0,066		



Grudna skolioza (cm)	1	2	0,026	0,788	3,098	0,027		
		3	0,200	0,037				
		4	0,226	0,031				
	2	3	0,173	0,032				
		4	0,199	0,029				
	3	4	0,026	0,767				
Slabinska skolioza (cm)	1	2	-0,048	0,269	2,466	0,062		
		3	0,033	0,439				
		4	0,048	0,301				
	2	3	0,082	0,024				
		4	0,097	0,017				
	3	4	0,015	0,696				
							F	P
							4,233	0,000

Legenda: Md- razlika između aritmetičkih sredina; f- vrednost f testa; p-statistička značajnost; F - vrednost multivarijatne analize varijanse

DISKUSIJA I ZAKLJUČAK

Ovim istraživanjem dobijen je uvid u celokupni posturalni status kičmenog stuba u sagitalnoj i frontalnoj ravni kao i razlike između grupa kod posmatranog uzorka dečaka uzrasta od 4 – 13 godina.

Polozicije markiranih tačaka kičmenog stuba u sagitalnoj ravni sa uzrastom poprimaju karakter povećanja vratne lordoze, grudne kifoze i slabinske lordoze prema rezultatima u odnosu razlika srednjih vrednosti grupa ispitanika koji su prikazani u Tabeli 2. Sagledavajući dobijene rezultate uočava se da postoje statistički značajne razlike ($p=0,000$) između grupa ispitanika u posmatranim varijablama grudna kifoza ($p=0,000$) i slabinska lordoza ($p=0,000$). Do sličnih podataka, došli i drugi istraživači koji su ustanovili zastupljenost ovih posturalnih poremećaja u grudnoj i slabinskoj lordozi takođe na uzorku predškolske i mlađe školske dece (Bogdanović i Milenković, 2008; Đokić, Međedović i Smiljanić, 2011).

Istraživanja koja su se bavila problemom pojave povećanja grudne kifoze u ovom uzrastu, navode da je glavni uzrok nastanka kifotičnog lošeg držanja smanjena fizička aktivnost dece i dugotrajno zauzimanje sedećeg položaja.

Ovakav sedentarni način života kod dece predškolskog i školskog uzrasta, mahom dovodi do progresivnog slabljenja mišića opružaća kičmenog stuba te zastupljenosti ovog posturalnog poremećaja (Kosinac, 2005).

Statistički značajna razlika između posmatranih grupa ispitanika zapažena je i u varijabli slabinska lordoza. Utvrđeno je da je najstarija grupa ispitanika (Grupa 4) imala najveće odstupanje u sagitalnoj ravni u odnosu na normalnu fiziološku krivinu. Ova pojava odstupanja slabinske lordoze nastaje prilikom delovanja neke spoljašnje sile u dužem vremenskom periodu. Pretpostavlja se da se dejstvo ove spoljašnje sile upravo ogleda u periodu polaska u školu, gde su učenici izloženi velikim težinama školskih torbi koji najčešće prelaze preporučenu težinu od 10% ukupne telesne mase deteta (Fošnarič, 2007).

Posmatrajući rezultati (Tabela 2.) kod varijabli grudna skoliza, vratna skolioza, slabinska skolioza i vratna lordoza nisu uočene statistički značajne razlike. Ipak primećuje se pogoršanje statusa kičmenog stuba sa uzrastom i veća odstupanja pozicija markiranih tačaka od ose koja prolazi kroz sacrum u frontalnoj ravni. Na osnovu toga, primetno je, da bi se mogli razviti poremećaji kičmenog stuba u frontalnoj ravni ukoliko se pravovremeno ne interveniše primenom korektivnih vežbi.

Analizom svih dobijenih rezultata može se reći da je ukupan posturalni status kičmenog stuba posmatranog uzorka ispitanika narušen i ne spada u pravilno držanje tela (Protić-Gava, 2014). Ustanovljeno je da postoje statistički značajne razlike u posturalnom statusu kičmenog stuba u sagitalnoj ravni, te da je izražen negativan trend koji ide u prilog povećavanju zakrivljenosti grudne kifoze i slabinske lordoze u onoj meri koja odstupa od normalnih fizioloških vrednosti.

Dobar deo ovih rezultata može se objasniti činjenicama da se značajnim smanjenjem fizičke aktivnosti, polaskom u školu kod mlađih i boravkom u školi starijih dečaka doprinosi sve češćoj pojavi mišićnih disbalansa koje zatim direktno vode ka nastanku posturalnih poremećaja kičmenog stuba.

Ovakvi problemi koji su učestali na populaciji predškolskog i mlađeg školskog uzrasta trebalo bi u budućnosti strateški rešavati uvođenjem adekvatnog korektivnog tretmana vežbanja. Nakon toga trebalo bi ponovo sprovesti i istraživanje u cilju sagledavanja efekata korektivnih vežbi na otklanjanje nastalih poremećaja pravilnog držanja tela.

Uzrasni period od 4 do 13 godine je najsenzitivniji period rasta i razvoja kod dece., stoga je od velike važnosti delovati preventivno u pravcu smanjivan-

ja zastupljenosti posturalnih poremećajau ovom periodu života. Konstantnom edukacijom roditelja, kao i pristupanje stručnom, korektivnom vežbanju sprovedenom na sistematski način, moguće je preduprediti nastanak deformiteta a posebno onih koji su vezani u vezi sa kičmenim stubom. Na taj način doprinosi se ostvarivanju pravilnog držanja tela te se omogućava pravilan i nesmetani rast i razvoj ostalih mehanizama i funkcija tela deteta.

ZAHVALNOST

Ovaj istraživački rad nastao je uz pomoć Evropske Unije, IPA programa prekogranične saradnje Srbija – Bosna i Hercegovina realizacijom projekta „Unapređenje posturalnog statusa i statusa kičme“ – SPINELAB - 2013/323-164, te se ovim putem zahvaljujemo a posebno svim predškolskim i školskim intitucijama, roditeljima i deci koji su podržali projekat i učestvovali u ovom istraživanju.

LITERATURA

Bala, G., Jakšić, D. i Popović, B. (2009). Trend relacija morfoloških karakteristika i motoričkih sposobnosti dece. U G. Bala (ur.), *Relacije antropoloških karakteristika i sposobnosti predškolske dece*[*Relationships Between Anthropological Characteristics and Abilities of Preschool Children*] (str. 61-112)

Bogdanović, Z. (2005). Prisustvo kifotičnog i lordotičnog lošeg držanja tela u zavisnosti od načina nošenja školske torbe (Manifestation of kyphotic and lordotic bad body posture influenced by backpack carrying type). In S. Joksimović (Ed.), *Proceedings of "Fis-communications 2005"*, (pp. 59-65). Nis: Faculty of Physical Education.

Bogdanović, Z., Milenković, S. (2008) Morfološki prostor i posturalni poremećaji kod mlađeg školskog uzrasta. *Glasnik Antropološkog društva Srbije*, 43, str. 371-378.

Đokić, Z., Međedović, B., & Smiljanić, J. (2011). Stanje uhranjenosti, posturalni status i kvalitet sprovođenja nastave fizičkog vaspitanja u osnovnim školama. *TIMS Acta - Journal of sport sciences, tourism and wellness*, 5(1), 10-19.

Fošnarič, S., I. Delčnjak-Smrečnik (2007). Physical overburdening of pupils with the weigh of school bags during the period of passing from eight year primary school to nine year primary school. *Informatologia*, 40, 3:207-210.

Kojić, M. (2014). Differences in indicators of postural status between boys and girls from Srem. *Exercise and quality of life*, 6 (1), 17-22.

Kosinac, Z. (2005.), Kineziterapija sustava za kretanje. Sveučilište u Splitu, Udruga za šport i rekreaciju djece i mladeži grada Splita. 137.-201.

Milenković, S., Živković, D., Milijić, S., Ignjatović, I. & Pavlović, Z. (2003). Stanje posturalnih poremećaja i telesnih deformiteta dece mlađeg školskog uzrasta u opštinama Zaječar, Kruševaci Čačak. *Proceedings of "Fis-communications 2003"*, (pp.320-324). Nis: Faculty of Physical Education.

Milenković, S.M., Kocijančić, R.I. & Belojević, G.A. (2004). Left handedness and spine deformities in early adolescence. *European Journal of Epidemiology*, 19 (10), 969-972.

Mišigoj-Duraković, M. (2006). *Kinantropologija - biološki aspekti tjelesnog vježbanja*. Zagreb: Kineziološki fakultet.

Pantelić S, Nikolić M, Đurašković R. (2010). Razvojne karakteristike sedmogodišnjih dečaka iz različitih vremenskih perioda. *Glasnik ADS*, 45, 319 326.

Pavlović, M. (1999). *Ishranjenost dece u Severnbackom okrugu*. Subotica. Zavod za zaštitu zdravlja.

Penha, P.J., Joao, S.M.A., Casarotto, R.A., Amino, C.J. & Penteadó, D.C. (2005). Postural assessment of girls between seven and ten years of age. *Clinics*, 60 (1), 9-16.

Protić-Gava, B. (2014). The importance of postural status for the health of children and youth. *Exercise and quality of life*, 6 (1), 17-22.

Purenović, T (2006). Razlike u posturalnom statusu kičmenog stuba između učenika instrumentalista Srednje muzičke škole u Nišu (The differences in postural status of spinal column between pupils musicians from Music High School in Nis). In D. Petković (Ed.), *Proceedings of "Fis-communications 2006"*, (pp. 280-284). Nis: Faculty of Sport and Physical Education.

Madić, D. (Ed.). (2014). *Improving testing abilities on postural and spinal column status – Spinelab*. Novi Sad: Faculty of Sport and Physical Education.

Status kičmenog stuba u sagitalnoj ravni kod devojčica

Tijana Šćapanović, Dragan Marinković, Darinka Korovljević, Dejan Madić

Fakultet sporta i fizičkog vaspitanja, Univerzitet u Novom Sadu, Novi Sad, Srbija

ABSTRACT

The aim of the research was to determine the differences in postural status of the spine in the sagittal plane in girls of different age groups. The study included 416 female subjects, aged 7.68 ± 2.07 years. Assessment of the status of the spine was made by Contemplas-Templo capture system for assessing postural status in the 3D analysis of postural status. Multivariate analysis of variance (MANOVA) indicated that there was a statistically significant difference in the overall system variables. Separately by variables, a statistically significant difference in the status of the spine between the age categories was observed. Based on these results we can say that the cervical and lumbar lordosis increases and thoracic kyphosis decreases with age.

Keywords: 3D analysis, postural status, Contemplas, IPA Spinelab

UVOD

Pravilno držanje tela ima nemerljivo veliki značaj za pravilan rast i razvoj dece i omladine, jer su koristi koje deca i omladina imaju od dobrog držanja tela brojne. Lepo držanje tela čini da se osoba oseća snažnije, lepše i da zrači sigurnošću. Pravilno držanje tela pomaže prevenciji povreda i redukuje bol. Posturalni status se može definisati kao kombinacija pravilno postavljenih segmenata tela prilikom kretanja (Kendall, McCreary, i Provance, 1993) i njihov međusobni balans (Paušić i Dizdar, 2011). Dobar posturalni status sprečava zamor, jer se mišići efikasnije koriste i omogućavaju telu da troši manje energije. Ukoliko pojedinci usvoje dominantan, pravilan uspravan stav, sposobni su da izdrže veći bol u odnosu na osobe koje su usvojile loše držanje tela.

Naučnici smatraju da dominantno dobro držanje tela šalje signale mozgu koji može da ima veću kontrolu svog statusa tela i okoline. To se zovu hormonalne promene i u stanju su da proizvedu "hormone-ubice bola". Loše držanje tela podrazumeva funkcionalno odstupanje od normalnog posturalnog statusa, kod koga nema strukturalnih promena na kičmenom stubu ili donjim ekstremitetima, a karakteriše se slabošću celog organizma, naročito zglobovno-mišićnog aparata. Rezultati dobijeni istraživanjima pokazuju da su poremećaji posture već kod dece predškolskog uzrasta veoma česti i da postoje problemi vezani za posturalne poremećaje kičmenog stuba, razvijenost grudnog koša, odnosno donje ekstremitete – kolena i stopala, kako kod dečaka tako i kod devojčica. Poslednjih godina je učestala pojava skoliotičnog lošeg držanja i to češće kod devojčica. Kritičan period pojave skoliotičnog lošeg držanja predstavlja period od 12 godine života, gde odnos pojave kod dečaka i devojčica iznosi 35%:45%. Ukoliko se ova faza prebrodi pravilnim korektivnim vežbama, njena prisutnost u daljem rastu i razvoju deteta opada. Za identifikaciju ovog poremećaja kao i drugih koriste se razne metode. Somatoskopska kao vizuelna metoda pruža uvid u držanje tela i status kičmenog stuba na praktičan ali nedovoljno precizan način. Sa druge strane somatometrijska metoda je mnogo preciznija iz razloga što se primenjuju instrumenti pomoću kojih vrednosno kvantifikujemo poremećaj. Veliki je broj metoda kojima je moguća procena statusa kičme pomoću dostupnih dijagnostičkih aparata i mernih instrumenata. Ove metode razlikuju se po veličini, preciznosti, dostupnosti a svaka od njih ima svoje prednosti i mane. Iz palete opreme, izdvaja se biplanarna radiografija, optičko-električni sistemi, elektomagnetni sistemi za praćenja kao i 3D sistem praćenja kretanja i posture (Tomsšević-Todorović, 2014)

CONTEMPLAS *Templo professional motion analysis software*, pouzdano je i savremeno sredstvo za dijagnostiku i detektovanje posturalnih poremećaja. Zbog svoje 3D analize, Contemplas daje mnogo više podataka o posturalnom statusu u poređenju sa dosadašnjim metodama uz pomoć kojih se ovaj problem dijagnostikovao. Precizni rezultati dobijaju se markiranjem određenih tačaka na telu ispitanika. Tačnost sistema potvrđena je od strane Sportskog Univerziteta u Kelnu. Modul 3D sastoji se od tri kamere uz pomoć kojih se ljudski pokret beleži i automatski analizira iz sve tri perspektive. Ova metoda pruža širok izbor mogućnosti za mnoge specifične potrebe kao i prilagođavanje mnogim hardverskim rešenjima uz pomoć kojih se mogu vršiti razne analize kretanja, pasivnih položaja i doneti zaključke o potrebama, znanju ili uzroku nastanka deformiteta (Madić, 2014). TEMPLO softver je projektovan kao mod-

ularni sistem, tako da može da se unapredi funkcijom koja je potrebna. Posturalna analiza je poseban modul a element TEMPLO softvera uključuje preko 10 različitih protokola za 2D i 3D posturalnu analizu. 3D Compact je analiza za procenu posturalnog statusa i statusa nogu koje podrazumeva korišćenje tri kamere pomoću kojih se telo sinhronizovano snima i analizira u tri perspektive istovremeno. U 3D analizi korišćene su retroreflektivne markirne loptice koje daju mogućnost najpreciznijeg merenja posturalnog statusa i statusa nogu neinvazivnom metodom.

Problem ovog rada predstavlja analizu statusa kičme u sagitalnoj ravni devojčica predškolskog i školskog uzrasta na teritoriji Srema (Srbija), a cilj istraživanja je bio utvrditi primenom savremene metode u detekciji posturalnih poremećaja razlike u statusu kičmenog stuba u sagitalnoj ravni kod devojčica u odnosu na uzrasne kategorija.

METOD

Istraživanjem je bilo obuhvaćeno 416 ispitanika ženskog pola, uzrasta $7,68 \pm 2,07$ godina ($TV=129,07 \pm 14,22$ cm; $TM=28,94 \pm 9,48$ kg). Testiranje je realizovano okviru međunarodnog IPA projekta pod nazivom Unapređenje posturalnog statusa i statusa kičme - SPINELAB, na području Srbije i Bosna i Hercegovine ("Improving testing abilities on postural and spinal column status / SPINELAB" Grant Contract 2013/323-164). Testiranja su vršena u predškolskim i školskim ustanovama Indije, Rume, Stare Pazove i Sremske Mitrovice. Testiranjem i merenjem se procenjivao posturalni status primenom savremene fotometrijske aparature CONTEMPLAS GmbH TEMPLO koja podrazumeva sistem kamera i softversku analizu i kojom se utvrđuje pozicija markiranih tačaka u prostoru prema 3D Posture Analysis protokolu. Ispitanice su bile podvrgnute postavljanju 16 reflektujućih markera nakon čeka je sledilo postavljanje u kalibrisani prostor i fotografisanje pomoću tri kamere (Basler acA645-100gm/gc). Kompjuterskom analizom utvrđeni su parametri koji određuju status kičmenog stuba u sagitalnoj ravni u sledećim varijablama:

- Vratna lordoza - markirana pozicija sedmog vratnog pršljena u odnosu na osu koja prolazi vertikalno kroz sacrum u sagitalnoj ravni;
- Grudna kifoza - markirana pozicija najisturenijeg pršljena grudne krivine u sagitalnoj ravni
- Slabinska lordoza – markirana pozicija najudubljenijeg pršljena slabinske krivine u sagitalnoj ravni

Celokupni uzorak ispitanika podjeljen je u četiri kategorije u odnosu na uzrast, 4-5,9 godina (N=92), 6,0-6,8 godina (N=104), 6,9-9,2 godina (N=98), i 9,3-13,5 godina (N=122). Analiza dobijenih podataka podrazumeva primenu Multivarijatne i Univarijatne analize varijanse sa ciljem da se utvrdi da li postoje razlike u statusu kičmenog stuba između devojčica različitog uzrasta. Podaci su obrađeni uz pomoć statističkih procedura u softverskom rešenju SPSS 20.0.

REZULTATI

Na ukupnom uzorku ispitanika, izračunati su centralni i disperzioni parametri, koji ukazuju da je uzorak heterogen i da odstupa od normalne distribucije (Tabela 1.). Negativne vrednosti kurtozisa se javljaju kod telesne visine. Parametri kičmenog stuba imaju normalnu distribuciju, posmatrajući vrednosti standardne devijacije, ali se minimalne i maksimalne vrednosti razlikuju i brojčano i predznakom. Rezultati su heterogeni uz velike individualne razlike, što je bio razlog podele u četiri uzrasne kategorije.

Tabela 1. Osnovni statistici ispitanika svih grupa

Varijable	N	Min	Max	M	Sd	Ske	Kurt
Telesna visina	416	103,10	180,30	129,0703	14,22978	,510	-,326
Telesna težina	416	14,80	67,10	28,9403	9,48293	,993	,667
Vratna lordoza	416	-4,65	8,88	1,8311	2,10550	,195	,432
Grudna kifoza	416	-5,91	6,06	-1,0321	1,73454	,412	,720
Slabinska lordoza	416	-,81	5,36	2,1030	1,10838	,453	,216

Legenda: N-broj ispitanika; Min-minimalne vrednosti; Max-maksimalne vrednosti; As-aritmetička sredina; Sd-standardna devijacija; Ske-skjunis; Kurt-kurtozis

Testirane su razlike između grupa ispitanika Multivarijatnom analizom varijanse i utvrđeno je da se grupe ispitanika statistički značajno razlikuju ($P=0,000$) u odnosu na posturalni status u sagitalnoj ravni. Pojedinačno posmatrajući varijable na osnovu Univarijatne analize varijanse, dokazano je da se grupe ispitanika statistički značajno razlikuju u sva tri posmatrana segmenta kičmenog stuba. Primetno je takođe da se u svim varijablama za procenu statusa kičmenog stuba u sagitalnoj ravni prema vrednostima aritmetičkih sredina status menja u jednom pravcu. Prema tome vratna lordoza se povećava; grudna kifoza se smanjuje dok slabinska lordoza ima tendenciju ka povećanju.

Tabela 2. Analiza razlika u posturalnom statusu ispitanika prema uzrasnim kategorijama

	Kategorije	N	As	Sd	F	p
Vratna lordoza	4-5,9	92	1,2239	1,93669	6,676	,000
	6,0-6,8	104	1,5036	1,76041		
	6,9-9,2	98	2,0920	2,23526		
	9,3-13,5	122	2,3585	2,25875		
Grudna kifoza	4-5,9	92	-1,6738	1,54168	9,675	,000
	6,0-6,8	104	-1,3049	1,41646		
	6,9-9,2	98	-,5763	1,79780		
	9,3-13,5	122	-,6705	1,87749		
Slabinska lordoza	4-5,9	92	1,5361	,84423	32,529	,000
	6,0-6,8	104	1,6761	,87890		
	6,9-9,2	98	2,6523	1,06796		
	9,3-13,5	122	2,6997	1,14591		
				F=12,006		P=0,000

Legenda: N-broj ispitanika; As-aritmetička sredina; Sd-standardna devijacija; f-vrednost f testa; p-statistička značajnost; F-vrednost multivarijatne analize varijanse; P-statistička značajnost

Pojedinačno posmatrajući varijable na osnovu Univarijatne analize varijanse, dokazano je da se grupe ispitanika statistički značajno razlikuju u sva tri posmatrana segmenta kičmenog stuba. Primetno je takođe da se u svim varijablama za procenu statusa kičmenog stuba u sagitalnoj ravni prema vrednostima aritmetičkih sredina status menja u jednom pravcu. Prema tome vratna lordoza se povećava; grudna kifoza se smanjuje dok slabinska lordoza ima tendenciju ka povećanju.

DISKUSIJA I ZAKLJUČAK

Rezultati istraživanja koji je imao za cilj da utvrdi razlike u statusu kičmenog stuba u sagitalnoj ravni kod devojčica ukazuju da se i na generalnom nivou i zasebno po varijablama javljaju razlike. Takođe se primećuju i određeni trendovi i pomeranja parametara statusa kičme u sagitalnoj ravni u zavisnosti od uzrasne kategorije. Kako bi analiza dobijenih rezultata bila što preciznija,

mora se krenuti od samog načina testiranja. Naime, markacija je postavljena na četiri referentne tačke kičmenog stuba. Posmatrano iz sagitalne ravni, u vratnom delu, marker je postavljen na C7, a u grudnom i slabinskom delu na prominentnom pršljenu. Četvrti marker se postavlja na Sacrum. U odnosu na sakrum povlači se vertikala i mere se distance ostalih markera kičmenog stuba od vertikale. Fiziološke krivine (cervical, thoracis, lumbal) imaju takav odnos da se kod distance predznak razlikuje; cervicalni i lumbalni deo imaju pozitivan predznak, dok thoracis ima negativan predznak. Za normalo funkcionisanje kičmenog stuba, amortizaciju i pokretljivost, neophodno je da se sačuvaju navedeni odnosi tri distance u odnosu na sacrum. Svako povećanje ili smanjenje fiziološke krivine sa sobom nosi rizik od nastanka posturalnih poremećaja i telesnih deformiteta. Na osnovu dobijenih podataka, možemo zaključiti da se kod ispitanika sa godinama povećava vratna i slabinska krivina a da se smanjuje grudna krivina kičmenog stuba. Povećanje vratne i slabinske lordoze, potvrđuju se i u dosadašnjim istraživanjima kod ovog uzrasta (Protić-Gava, B. i sar., 2009). Lordoza se kod devojčica uzrasta 8-9 godina, javlja čak 51% više nego kod dečaka. Smanjenje grudne krivine kod ispitanika,, može se tumačiti izmeštanjem centra težišta tela unapred, koje je rezultat pomeranja glave. U praksi poslednjih godina, prilikom testiranja kliničkom metodom, primetno je da se glava pomera unapred a samim tim i ceo gornji deo tela. Karlica se naginje unapred, te se povećava slabinska lordoza, kojom se stvara kompenzacija i istovremeno ravnotežni položaj. Do ove pojave može doći zbog loše navike seda za stolom (školska klupa, radni i kancelarijski sto), pogotovo koristeći računar. Sa ovim problemom se susreću mladi i odrasli kod kojih se javljaju bol pa čak i invalidnost (Ho Ting Yip i sar., 2008).

Kritične tačke u rastu i razvoju za nastanak deformiteta su juvenilni period (od 4. do 7. godine) i adolescentni (od 11. godine) koji se označavaju kao vremenski periodi kada je neophodno posebno obratiti pažnju na moguću pojavu deformiteta. Ubrzani rast i razvoj deteta sa sobom rizik nesrazmernog razvitka, tako što, mišići nisu u stanju da prate rast kostiju. Često se tome pridruže i dodatna opterećenja, kao što su dugo sedenje, stajanje, ergonomija nameštaja, školska torba. Posturalni status kada je reč o deci kod koje nije završen rast i razvoj uvek bi trebalo tumačiti udruženo sa morfološkim karakteristikama (Šćepanović, 2011). Vaspitno obrazovni zadaci osnovnoškolskog uzrasta podsećaju nas na važnost fizičke aktivnosti dece, kao i preventivnom radu (Krsmanović, 2007).

ZAHVALNOST

Ovaj istraživački rad nastao je uz pomoć Evropske Unije, IPA programa prekogranične saradnje Srbija – Bosna i Hercegovina realizacijom projekta „Unapređenje posturalnog statusa i statusa kičme“ – SPINELAB - 2013/323-164, te se ovim putem zahvaljujemo a posebno svim predškolskim i školskim intitucijama, roditeljima i deci koji su podržali projekat i učestvovali u ovom istraživanju.

LITERATURA

Ho Ting Yip, C., Tai Wing Chiu, T., Tung Kuen Poon, A. (2008). The relationship between head posture and severity and disability of patients with neck pain. *Manual Therapy*, 13, 148–154.

Krsmanović, T. (2007). Posturalni poremećaji i kako ih sprečiti. *Glasnik antropološkog društva Jugoslavije*, 42, 369-375.

Protić-Gava, B., Krsmanović, T., Jevtić, N. (2009). Postural disorders in sagittal plane and differences according to gender. *Fizička kultura*, 37, 2 (134-137).

Madić, D. (Ed.). (2014). *Improving testing abilities on postural and spinal column status – Spinelab*. Novi Sad: Faculty of Sport and Physical Education.

Šćepanović, T., Protić-Gava, B., Dimitrić, G., Batez, M. (2011). Razlike u posturalnim poremećajima kičmenog stuba sagitalne ravni adolescenata grupisanih prema morfološkim karakteristikama. *Glasnik antropološkog društva Srbije*, 46, 377-381.

Paušić, J., & Dizdar, D. (2011). Types of Body posture and their characteristics in boys 10 to 13 years of age. *Collegium Antropologicum*, 35 (3), 747–754.

Kendall, F.P., McCreary, E.K., & Provance, P.G. (1993). *Muscles, testing and functions*. (4th ed.). Baltimore: Williams & Willkins.

Tomašević-Todorović, S. (2014). Physiotherapy Aspct of Diagnostic and Treatment of Postural Disorders. *Exercise and Quality of Life*, 6(1), 7-15.

Method of Educational Kinesiology in the therapy of people with aphasic speech disorder – possibilities and limitations

Danuta Grzesiak-Witek, Paweł Witek

The John Paul II Catholic University of Lublin, Poland

ABSTRACT

The article refers to the application of selected exercises of educational kinesiology in speech therapy of people with aphasic speech disorders. Aphasia is a speech disorder resulting from the damage of the brain area responsible for speech production and/or comprehension. The therapy of aphasia is a long-term process sometimes bringing scant effects. Therefore, therapists are still searching for new, original therapeutic methods. One of the methods supporting and enriching the therapy is educational kinesiology. This method enables to overcome stress and tension connected with the lack of possibility to communicate verbally. Systematic use of educational kinesiology influences the real creation of nerve connections in the brain, thanks to which the therapy proceeds more effectively.

Key words: aphasic therapy, educational kinesiology

INTRODUCTION

The characteristics of aphasic speech disorders

Aphasia is a speech disorder resulting from the damage in the centres responsible for speech production and/or comprehension in the brain. In neurological terminology, as well as in speech therapy, in order to show the depth of disorders, aphasia has been distinguished from dysphasia: "aphasia is the total lack of speech (speaking and/or comprehending), while dysphasia includes partial loss of speech due to the damage of cortical structures respon-

sible for transmission and reception" (Jastrzębowska, Kozolub 2001: 585). The picture of aphasic speech disorders depends on numerous factors, e.g., place and degree of brain damage, psychophysical condition of a patient prior to the sickness, disorders accompanying aphasia. It refers to various forms of linguistic behaviours, including speech production and its comprehension, the ability to imitate phonemes (sounds), words, sentences, as well as writing and reading. From numerous classifications of aphasia which have been elaborated in the course of many years of research, the Authors are going to present the typology by Alexander Romanovich Luria. Within this typology there are: kinesthetic aphasia (articulation disorders resulting from searching for the appropriate position of speech organs, with clear distortion while producing words but with appropriate speech comprehension); kinetic aphasia (fluency disorder in moving between phonemes in syllables and words, the telegraphic style or chanting); dynamic aphasia (internal speech disorder and problems in creating spontaneous speech); acoustic-gnostic aphasia (problems in speech comprehension, as well as writing and reading, the occurrence of phoneme substitutions in the process of speech production); acoustic-mnemonic aphasia (disorders of memory traces of words, difficulty in repeating and comprehending long speeches); semantic aphasia (disorders in simultaneous synthesis which is the basis of comprehending complex verbal constructions and relations between words in a sentence) (Luria 1976).

The brain damage occurs as a result of stroke (ischemic, haemorrhagic), car accident, robbery or the neurodegenerative diseases. It must also be noted that not every brain damage causes aphasic speech disorders. Statistics report that about 60% of people after stroke have problems with verbal communication. Aphasic speech disorders appear when the left cerebral hemisphere is damaged, more rarely the right hemisphere or cortical structures. In some cases aphasia can be caused by brain tumours in the brain itself or which influence its damage. The literature also points to herpesviral encephalitis and epileptic seizure as possible causes of aphasic speech disorders (Howard S. Kirshner 2006: 191-192).

The review of selected therapeutic methods of aphasia

The therapy of aphasia is a long-term and tedious process. So you must wait for its effects for many years. Searching for the effective help, speech therapists worked out many methods and therapeutic programmes. "While presenting the basic therapy methods, it is difficult to draw the border which of

them are to be recognised as historical methods and which are the modern ones. Here, it is not the date of the therapeutic approach which is important in this division. There are therapy programmes prepared several hundred years ago but they are still used because of their efficacy" (Grzesiak-Witek 2013: 97). Among them one must mention Joseph M. Wepman's *Psychological concept of re-education of aphasics*, who links speech therapy with the reconstruction of patients' personality; *The Functional Communication Profile of Martha Taylor*, based on the distinction used in neurology between clinical and functional kinetic disorders (Przesmycka-Kamińska 1980: 19). In Poland in the past there is a well-known method of aphasia therapy by Mariusz Maruszewski, according to whom the selection of therapy should depend on the view of the location of higher psychical functions in the brain (Maruszewski 1966: 337). Apart from the above mentioned therapeutic programmes, there were the so-called alternative ways of communicating with an aphasic, using gestures, drawings and symbols in communication. Here, one must mention the *Visual Action Therapy* by N.A. Helm and D.F. Benson; the programme called *Back to the Drawing Board* (BDB); the *Visual Communication System* (VIC) used in therapy of people with total aphasia; *Symbols of Charles K. Bliss* (see: Grzesiak-Witek 2013: 99- 112). The methods presented above constitute just a part of all the therapeutic systems prepared in the past.

Modern therapy of aphasia pays attention to the necessity to start the speech early in order to prevent false compensation. "Some therapeutic methods used at present are presented as models" (Grzesiak-Witek 2013: 118). The model of the so-called *substitute abilities*, enables to communicate despite still persistent linguistic disorders. Whereas, the *model of direct treatment intends to restore the linguistic abilities prior to sickness*. In case of this model the progress is limited in the case of older patients, whose brain reorganisation is minimal (Jodzio 2005: 207). In Polish neurological and rehabilitation wards, speech therapists use computer programs, e.g., *AfaSystem* prepared by the employees of Clinical Neuropsychology Lab in the Neurological Clinic II IPIN in Warsaw. It is used to restore linguistic communication in terms of expression, comprehension, writing and reading. Bearing in mind that in the case of older patients, there might appear difficulties in using computer software so also more traditional aids are used in aphasia therapy. It may be the word-and-picture material prepared by Bożena Strachalska, to improve the word revival (Stachalska 2002) or a valuable teaching aid by Jagoda Cieszyńska *Diagnosis and therapy of aphasic disorders*. In J. Cieszyńska's proposal, the material was

adjusted to adult patients with aphasia, possible to be used both for diagnostic as well as therapeutic purposes (Cieszyńska 2009). Among modern approaches to speech therapy of adult aphasics, there is also a proposal of the Author of this article described in the book *Diagnosis and Speech Therapy of People with Motoric Aphasia. Restoring linguistic competence and language system* (Grzesiak-Witek 2013). The work model with a patient described in this publication treats "speech as a means of interpersonal contacts, and language signs as communication tools. [...] The restoration of skills of communicating through speech enables the patient to return to the society. The aim of working with an aphasic is to help a patient to fulfil appropriate social roles, if not to the extent as before the illness, then at least partially" (Grzesiak-Witek 2013: 126).

Bearing in mind the necessity of continuous search for new solutions in the work with people with aphasic speech disorders in order to make the work more effective and the exercises more interesting for the patient, the Authors of this article reflects on the possibility of using Paul Dennison's method.

Educational kinesiology method in aphasia therapy

Educational kinesiology method is also referred to as the method prepared by Paul Dennison, who was its creator in the 1980s. It proves that physical movement is important to activate natural learning processes. It is based on two principal movements: movements crossing the median line of the body and unilateral body movements. Particularly valuable are movements between the left and the right side, as they activate integration mechanisms, facilitate learning and ensure proper work of the nervous system. The many-year long research conducted by Dennison resulted in the development of numerous exercises acting on various levels of the organism (Dennison 2003). It is important that the exercises be conducted in a defined order and systematically repeated. The time devoted to perform one exercise cannot be longer than a few minutes. A therapist can select exercises focused on the improvement of a specific skill, e.g., fast reading, reading comprehension, correct writing, mathematical abilities, creative thinking, etc. It is also important that a therapist create his own programmes focused on improving those functions which are important in an individual case. Dennison's method distinguishes between four types of exercises: 1. Exercises to cross the medial body line (activating the work of both brain hemispheres); 2. Exercises to lengthen muscles (releasing muscle tension due to stress); 3. Energising exercises and exercises improving the activity of the brain and the body; 4. Exercises focusing on the

reinforcement of positive thinking (improving the activity of the limbic system of the brain, i.e., the centres of memory, emotions) (Grzywniak 2006).

Current state of research on educational kinesiology method in Poland

Intensive studies on educational kinesiology method were carried out during the International Scientific Conference held in Warsaw on 27th November 2007 under the patronage of the Ministry of National Education. The aftermath of this academic meeting was a publication of the book *Kineziologia edukacyjna: nauka, pseudonauka czy manipulacja?* [Educational Kinesiology: Science, Pseudoscience or Manipulation] (Koraba, Borowiecka, Petrykiewicz 2008). In 2005 the Ministry of National Education approved the book *Mój kuferek* [My Little Coffe], which includes the curriculum based on educational kinesiology (*Przewodnik metodyczny do ćwiczeń dla sześciolatka. Mój kuferek 2004* [A Guidebook to Exercises for Six-year Olds. My Little Coffe 2004]. Educational kinesiology is also used in pre-school education and early primary education, as well as in psychological and pedagogical therapy. This method was also recommended by Renata Czubaj, President of the Polish Dyslexia Association.

The proponents of Dennison's method unanimously believe that the regular use of movement and energising exercises improves the process of learning: "energising exercises enable the necessary speed and intensesness of nervous processes. They improve school skills, concentration skills, causing the increase of motivation to act" (Sadowska, Wieczorek, Gruna-Ożarowska 2006). The latest research by Katarzyna Bayer included in her publication *Od ćwiczenia do myślenia: oparte na kineziologii edukacyjnej Paula Dennisona* [From Practice to Thinking: Based on Paul Dennison's Educational Kinesiology] affirm the interesting implications of the use of this method (Bayer 2013). Moreover, Janina Duszyńska indicates that the presented method may be used in foreign language teaching (Duszyńska 2013). There are also interesting references to educational kinesiology found in the publication by Jagoda Cieszyńska-Rożek entitled *Krakowska metoda wobec zaburzeń rozwoju dzieci: z perspektywy fenomenologii, neurobiologii i językoznawstwa* [The Cracowian Method in View of Developmental Disorders in Children. From the Perspective of Phenomenology, Neurobiology and Linguistics] (Cieszyńska-Rożek 2013).

In order to present the educational kinesiology method thoroughly, some views must be quoted of scientists who doubt in the efficacy of the method. The sceptic group, unsure of the possibility to gain significant effects using

Dennison's method, includes Renata Borowiecka. She invokes the fact that this method is based on a scientifically unconfirmed ideology (Borowiecka 2009). Anna Grabowska, who conducted an expert evaluation of the scientific fundamentals of this method, took a similar view. In her report commissioned by the Neurobiology Committee of the Polish Academy of Sciences, Grabowska concludes that: "descriptions of processes and principles of brain functioning included in the publications on educational kinesiology have no sense from the scientific point of view" (Grabowska 2006). Considering the above comments, we must also emphasised here the statement by A. Grabowska indicating that some movement exercises contained in Dennison's program bring positive effects. In consideration of this optimistic remark, the Authors intend to present some possibilities of using the educational kinesiology method in the speech therapy of aphasics.

Possibilities and limitations of the use of educational kinesiology method in aphasia therapy

In aphasia therapy, Dennison's method allows to diversify long-lasting and tedious linguistic exercises which are very tiresome for a patient. Aphasics also manifest other non-linguistic symptoms accompanying communication difficulties. They are: distorted memory, lack of orientation in place, time and space, dyslexia, dyspraxia, dyscalculia. Many of these symptoms make functioning in everyday life highly difficult, e.g., difficulty in using the calendar, computer, fax or phone. Using selected exercises of the Dennison's method alleviates everyday memory problems. An additional asset of this method is the chance to minimise stress resulting from the lack of possibility of verbal communication. Speaking about the possible use of educational kinesiology method, one must also mention its limitations in the case of aphasics. The majority of patients after brain stroke show paresis of the extremities which makes them unable to perform some exercises. It is not possible to use the some exercises for patients with limb paresis, e.g., alternate movements of left and right limbs. Nevertheless, even this limitation can be overcome, introducing this group of exercises in the therapy when the disability disappears or diminishes and it becomes possible to perform such exercises.

Examples of practical application of selected exercises in the therapy

While choosing the exercises to be used in speech therapy of aphasics, one must focus exclusively on the group of exercises which improve the aphasic

disorder. Here, is the proposal of the use of selected exercises. “Dennison’s Position” is one of the most important positions in the canon of the method. It is recommended to be used in aphasia therapy as it results in calming down, relaxing, as well as in objectivising thinking. In the case of people having problems in communicating with the environment, relaxation is extremely important to assuage concerns and stress. In this posture the legs are crossed in the ankles, the hands are outstretched and turned palm-down to point the thumbs downwards. In this posture eyes are pointed upwards and the tongue is placed on the palate. “The Energy Yawn” helps to produce speech, revive difficult names and complicated linguistic phrases. Undoubtedly, these are the skills essential to people with all the speech disorders (not only with aphasia). In this exercise yawning is imitated, together with massaging muscles around the temporomandibular joint. This exercise relaxes the entire face, minimises tensions of the jaw and lip tightening. Another exercise which improves memory and facilitates comprehension of verbal messages is “the Owl”. In this exercise the air is exhaled slowly through the lips while one hand grasps the shoulder muscles and the head turns slowly left, and then right, keeping the chin straight. An additional asset of this exercise is that it assists speech production. To develop linguistic abilities and proper articulation of difficult words, the exercise called “Active Hand” is used. It is done by raising one hand with the simultaneous resistance to the other hand. Among the energising exercises worth recommending in aphasia therapy is the so-called “Thinking Cap”. The massage of the ear bowl is done with the fingers, from the top to the bottom of each ear. It serves to improve short-term memory and facilitates verbal communication and listening comprehension.

Apart from the above listed exercises used in the speech therapy of aphasia, other positions can also be used, the same as the ones used in the case of dyslexia. It must be added that in many cases, aphasia is accompanied by acquired dyslexia and dyspraxia. Exercises may include alternative movements, i.e., simultaneous turning of the left leg and the right hand. They are the most important exercises in educational kinesiology. “Thanks to these movements large areas of both brain hemispheres are activated while there are many new nerve connections being formed in the corpus collosum, which facilitates interhemispheric communication and paired organs such as eyes, ears, hands, legs and greatly improves cause and effect thinking” (Warszewski 2002: 91).

CONCLUSION

To sum up the reflexions on the possibility of using Dennison's method in the speech therapy of aphasia, it must be emphasised that it is necessary to search for new therapeutic solutions. It is difficult to assess whether the use of Dennison's method brings significant effects in the therapy, as the Authors have not conducted such research. In all the examined patients who take part in the speech therapy, both higher or lower improvement in verbal communication is noticed. However, it is difficult to assess whether the improvement results from the use of Dennison's method, or other methods or exercises which were not included in the article. The research on the efficacy of using the presented method in aphasic speech disorder therapy would be possible if all other techniques and methods were eliminated. It is neither necessary nor possible; this method cannot be used as one and the only, or even as the leading program. Including these dilemmas in the conclusion, it must be emphasised that these selected exercises are recommended to be used in a long-term therapeutic process. Nevertheless, these exercises should be excluded as the main and principal exercises, as in speech therapy the most important are exercises restoring the language.

BIBLIOGRAPHY

Bayer K., 2013, *Od ćwiczenia do myślenia: oparte na kinezylogii edukacyjnej Paula Dennisona, Part. 1*, Wydawnictwo Małe Jeżyki, Bełchatów.

Borowiecka R., 2009, *Kinezylogia edukacyjna – kontrowersyjna terapia* [Educational Kinesiology - A Controversial Therapy], „Przyjaciel. Dwumiesięcznik dla rodziców dzieci z wyzwaniami rozwojowymi”, nr 6 (19).

Cieszyńska J., 2009, *Diagnoza i terapia zaburzeń afatycznych*, Wydawnictwo Edukacyjne, Kraków.

Cieszyńska-Rożek J., 2013, *Metoda Krakowska wobec zaburzeń rozwoju dzieci. Z perspektywy fenomenologii, neurobiologii i językoznawstwa*, Omega Stages Systems, Kraków.

Dennison P. E., Dennison G., 2003, *Kinezylogia edukacyjna dla dzieci: podstawowy podręcznik Kinezylogii Edukacyjnej dla rodziców i nauczycieli*, Międzynarodowy Instytut Neurokinezylogii Warszawa.

Duszyńska J., Walczak S., 2013, *Wpływ ćwiczeń z kinezylogii edukacyjnej na skuteczność uczenia się słownictwa na lekcjach języka obcego* [The Influence of Educational Kinesiology on the Efficacy of Learning Vocabulary During a Foreign Language Lesson], „Przegląd Badań Edukacyjnych” No. 2, pp. 247-265.

Grabowska A., *Opinia dotycząca podstaw naukowych metody „Kinezylogii Edukacyjnej” oraz konsekwencji jej stosowania*, <http://www.kneurobiologii.pan.pl/images/stories/opinia%20dotyczaca%20podstaw%20naukowych%20metody%20kinezylogii%20edukacyjnej%20oraz%20konsekwencji%20ich%20stosowania.pdf>

Grzesiak-Witek D., 2013, *Diagnoza i terapia logopedyczna osób z afazją motoryczną. Odbudowanie kompetencji językowej i systemu językowego*, Wydawnictwo Naukowe Uniwersytetu Papieskiego Jana Pawła II w Krakowie, Kraków.

Grzywniak C., 2006, *Kinezylogia edukacyjna: metoda wspomaganie rozwoju i terapii psychomotorycznej*, Wydaw. Naukowe Akademii Pedagogicznej, Kraków.

Howard S. Kirshner, 2006, *Zaburzenia języka i mowy*, [w:] *Neurologia w praktyce klinicznej. Zasady diagnostyki i postępowania*, (Ed.) A. Prusiński, Wydawnictwo CZELEJ, Lublin t.1, pp. 171 - 198.

Jastrzębowska G., Kozołub A., 2001, *Afazja, dysfazja*, [in:] *Logopedia. Pytania i odpowiedzi*, (Eds) T. Gałkowski and G. Jastrzębowska, Wydawnictwo Uniwersytetu Opolskiego, Opole, pp. 585-610.

Jodzio K., 2005, *„Zdrowiejący mózg” – nowe spojrzenie na stary problem afazjologii*, [in:] *Neuralny świat umysłu*, Ed.. K. Jodzio, Impuls, Kraków, pp. 191-217.

Koraba K., Borowiecka R., Petrykiewicz E., (Eds.), 2008, *Kinezylogia edukacyjna: nauka, pseudonauka czy manipulacja?*, Instytut Badań Edukacyjnych, Warszawa.

Maruszewski M., 1966, *Afazja. Zagadnienia teorii i terapii*, PWN, Warszawa.

Przesmycka-Kamińska J., 1980, *Zaburzenia porozumiewania się słownego z otoczeniem w afazji*, Wydawnictwo Uniwersytetu Wrocławskiego, Wrocław.

Przewodnik metodyczny do ćwiczeń dla sześciolatka. Mój kuferek, 2004, Wydawnictwo JUKA, Warszawa.

Sadowska L., Wieczorek G., Gruna-Ożarowska A., 2006, *Gimnastyka mózgu według Paula i Gail Dennisonów dla dzieci z trudnościami w uczeniu się* [Brain Gym according to Paul and Gail Dennison for Children with Learning Difficulties], [in:] *Nowoczesne metody stymulacji rozwoju ruchowego i uczenia się dzieci z trudnościami w nauce, nadpobudliwością psychoruchową oraz autyzmem*, Międzynarodowy Instytut Neurokinezylogii Rozwoju Ruchowego i Integracji Odruchów, Warszawa.



Strachalska B., 2002, Ćwiczenia usprawniające aktualizację wyrazów w mowie osób z afazją, Wyd. APS, Warszawa.

Warszewski R., 2002, *Jak wyleczyłem dziecko z dysleksji*, seria: *Biblioteka Zdrowego Człowieka*, Wydawnictwo Tower Press, Gdańsk.

Analiza različitosti statusa posture kod djece iz ruralnih i urbanih sredina

Siniša Kovač¹, Denis Čaušević¹, Zana Bujak¹, Boris Metikoš²

¹Fakultet sporta i tjelesnog odgoja, Sveučilište u Sarajevu, Bosna i Hercegovina

²Tehničko veleučilište u Zagrebu, Hrvatska

ABSTRACT

The aim of this study was to determine the status of diversity posture in children from rural and urban areas. The research was conducted on a sample of 110 (55 from 55 rural and urban environments) subjects aged 7 to 10 years. The sample of variables consisted of 17 variables postural status made "3D Posture Compact" protocol on Contemplas equipment. Independent t-test showed a small statistically significant difference ($p \leq .05$) in postural status among children from rural and urban areas. Statistically significant differences were obtained for the variables: height and weight, trochanter rotation, Sag. Distance lumbar spine - sacrum, Varus / Valgus right, Cervical spine fr., Thoracic spine fr .. It was found that the complete postural status indicate a minor different to the respective groups of respondents. Poor posture status can lead to significant health problems and it is very important to take preventive action and the timely inclusion of children in a reliable valorization objectified diagnostic procedures and kinesio-therapeutical programs to eliminate postural problems.

Key words: body deformities, Contemplas, Templo

UVOD

Posturalni status ili držanje tijela sa adekvatnom valorizacijom stvarnog stanja nečijeg oblika tijela, je predmet različitih studija, na različitim razinama preciznosti posmatranih odstupanja od tako-zvanog pravilnog držanja tijela. Studije koje govore o odnosima antropoloških fenomena kod ispitanika iz

ruralnih i urbanih sredina često podcrtavaju različitosti kod tretiranih skupina. U ovom istraživanju ostavljen je prostor za diskusiju bez pretpostavke da u današnje doba stvarno postoje strukturalne razlike između takvih populacija. Današnje generacije, kako ruralne tako i urbane, svoju stvarnost često doživljavaju i proživljavaju kroz virtualni svijet što nosi sa sobom negativne posljedice na zdravlje (mentalno i tjelesno). Virtualni svijet mašte koji se oblikuje u svrhu masovnog korištenja, umanjuje mogućnost osobne kreativnosti, odvajajući ga od realnog života i osobne inicijative stvarajući stereotipe unificiranih mentaliteta (Andrijašević, 2009.). Analiza posturalnih kvaliteta, koja se u biti, kao dobra postura podrazumeva kroz optimalan odnos između smanjenja opterećenja kičmenog stuba i smanjenja ili optimalizacije, mišićnog rada (Standring, 2007.). Mišići nogu, zdjelice, trbuha i leđa zajedno sa kostima, zglobovima i ligamentima učestvuju u održavanju uspravnog stava tijela (posture). Poremećaji i bolesti današnjice - prekomjerna težina i živčana napetost, sve su više prisutni i kod mladih, a slobodno vrijeme djece i mladeži sve se više koristi za aktivnosti kojima nije potreban gotovo nikakav mišićni napor (Prskalo i sur., 2010.). Opće je poznato da mladi ljudi već u ranoj adolescentskoj fazi prihvaćaju nametnuti suvremeni način življenja. Kompjutorizacija, te sve prisutniji utjecaj interneta ostavljaju traga na zdravstvenom stanju čovjeka. Doba djetinjstva i adolescencije prepoznato je kao kritično razdoblje za usvajanje i zadržavanje navika prema tjelesnom vježbanju (Huddleston i sur., 2002.). Rezultati sistematskih pregleda ukazuju na nezadovoljavajuće stanje, posebno s obzirom na podatke o stanju stopala, kralježnice, učestalog lošeg držanja tijela i sve većeg postotka djece s prekomjernom tjelesnom težinom. Istovremeno, stručne analize i rezultati mnogobrojnih istraživanja ističu sve veće sklonosti djece k sedentarnom načinu života i nedostatku navike za redovnim tjelesnim vježbanjem. Koštani sustav u ovom dobnom periodu, posebno kralježnica i stopala, zahtijevaju pozornost tijekom školovanja: ispravljanje kralježnice, isuficijentna mišićna masa, nepravilan položaj pri sjedenju u školskim klupama, lako dovode do prijevremenih deformacija koji se moraju na vrijeme ispravljati (Ilić, 2009; Bogdanović i sur., 2008.). Tri su važna razdoblja u životu kada različiti uzroci mogu dovesti do poremećaja držanja tijela: Predškolsko razdoblje – u prvoj godini života djeteta se postepeno uspravlja i tada se oblikuju fiziološke krivine kičme. Ukoliko ova faza nastupi prerano, može doći do poremećaja držanja tijela. Školsko razdoblje – sa polaskom u školu za dijete nastaju velike promjene, te duže sjedenje u školskoj klupi, nošenje školske torbe i slično, može dovesti do poremećaja držanja tijela

(posture). Neki od faktora koji mogu doprinjeti poremećajima držanja tijela su: školska torba koja teži više od 10% tjelesne težine djeteta, nošenje školske torbe preko jednog ramena, nepravilno namještena školska torba i sl. (Avdić i sur. 2007.). S toga cilj ovog istraživanja predstavlja utvrđivanje različitosti statusa posture kod djece iz ruralnih i urbanih sredina.

METODE RADA

Uzorak ispitanika

Istraživanje je obuhvatilo 110 (55 iz ruralnih i 55 urbanih sredina) ispitanika školske populacije uzrasta od 7 do 10 godina iz osnovnih škola Sarajevo, Rakovica i Zvornik.

Uzorak varijabli

Prvi dio varijabli činili su su podaci o tjelesnoj visini i tjelesnoj težini ispitanika, dok drugi dio varijabli koje su korištene u istraživanju govore o statusu posture, valoriziranim upotrebom Contemplas 3D posture compact mode-a. Uzorak varijabli sačinjavalo je 17 varijabli dobijenih "3D posture compact" protokolom testiranja na Contemplas mjernom instrumentu. Dobiveni parametri ukazuju na eventualne otklone od nultih (normalnih) vrijednosti statusa posture u sve tri ravni, gdje su pomaci u posmatranim ravnima prikazani u centimetrima i stepenima. Veće vrijednosti odstupanja (pozitivno ili negativno) podrazumjevaju i veću razinu deformiteta. (Čirić i sur., 2015).

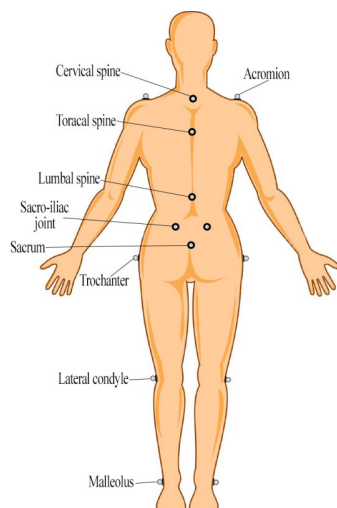

Slika 1. Postavljanje markera „3D Posture Compact“ protokol (Čirić, Čaušević & Bejdić, 2015.)

Tablica 1. Opis varijabli (Kovač i sur., 2014)

Shoulder displacement	Varijabla izražena u centimetrima, ukazuje na elevaciju/depresiju lijevog/desnog ramena u frontalnoj ravni.
Pelvic obliquity	Varijabla izražena u centimetrima, govori o podignutosti/spuštenosti lijeve/desne strane karlice u frontalnoj ravni.
Shoulder rotation	Varijabla izražena u stupnjevima koja daje informaciju o rotaciji po uzdužnoj osovini (transverzalna ravan) lijevog/desnog ramena.
Pelvic rotation	Varijabla izražena u stupnjevima, govori o rotaciji po uzdužnoj osovini (transverzalna ravan) lijeve/desne strane karlice.
Trochanter rotation	Varijabla izražena u stupnjevima, govori o rotaciji lijevog/desnog obrtača bedrene kosti po uzdužnoj osovini (transverzalna ravan).
Condylus rotation	Varijabla izražena u stupnjevima, govori o rotaciji koljena po uzdužnoj osovini (transverzalna ravan).
Malleolus rotation	Varijabla izražena u stupnjevima, govori o rotaciji osovine koja prolazi kroz maleoluse skočnog zgloba.
Sag. Distance cervical spine – sacrum*	Varijabla izražena u centimetrima, govori o udaljenosti najjisturenijeg cervikalnog (vratnog) pršljena od projekcije vertikalne linije sakruma (krstačne kosti) gledano u sagitalnoj ravni.
Sag. Distance thoracic spine – sacrum*	Varijabla izražena u centimetrima, govori o udaljenosti torakalnog (grudnog) dijela kičme od projekcije vertikalne linije sakruma (krstačne kosti) gledano u sagitalnoj ravni. *Veće vrijednosti odstupanja u pozitivnom ili negativnom smjeru se ne odnose na varijable "Sag. distance cervical, thoracic, lumbal – sacrum"
Sag. Distance lumbar spine – sacrum*	Varijabla izražena u centimetrima, govori o udaljenosti lumbalnog (slabinskog) dijela kičme od projekcije vertikalne linije sakruma (krstačne kosti) gledano u sagitalnoj ravni.
Varus/Valgus left	Varijabla izražena u stupnjevima, govori o uglu odnosa nadkoljenice i podkoljenice lijeve noge (medijalno/lateralno) u zglobu koljena.
Varus/Valgus right	Varijabla izražena u stupnjevima, govori o uglu odnosa nadkoljenice i podkoljenice desne noge (medijalno/lateralno) u zglobu koljena.
Flexion/Extension left	Varijabla izražena u stupnjevima, govori o hiperekstendiranosti ili flektiranosti lijeve noge u zglobu koljena (sagitalna ravan).
Flexion/Extension right	Varijabla izražena u stupnjevima, govori o hiperekstendiranosti ili flektiranosti desne noge u zglobu koljena (sagitalna ravan).
Frontal Cervical spine	Varijabla izražena u centimetrima, govori o udaljenosti vratnog dijela kičme u frontalnoj ravni od projekcije vertikalne linije sakruma.
Frontal Thoracic spine	Varijabla izražena u centimetrima, govori o udaljenosti grudnog dijela kičme u frontalnoj ravni od projekcije vertikalne linije sakruma.
Frontal Lumbar spine	Varijabla izražena u centimetrima, govori o udaljenosti slabinskog dijela kičme u frontalnoj ravni od projekcije vertikalne linije sakruma.

METODE OBRADJE REZULTATA

Rezultati su obrađeni u „SPSS 18“ software-skom paketu. Izračunati su parametri deskriptivne statistike za obje skupine ispitanika, te se uz korištenje T-testa izračunati parametri parcijalnih razlika između dvije skupine snimljene djece.

REZULTATI

Kada se pristupi analizi dobijenih parametara, nakon što je ponuđeni računalni program preračunao snimljene materijala u tri dimenzije a po osnovu kalibriranog prostora u kojem su bili pozicionirani ispitanici, dobiju se točna odstupanja iskazana u prostornim pomacima za karakteristične točke na tijelu, odnosno točni opsezi rotacijskih pomaka za drugi dio obilježenih repera. Potencijalne različitosti između dvije skupine djece iz ruralne i urbane sredine iskazane su u tabeli (Tabela 2.) sa svojim srednjim vrijednostima i odnosima datih vrijednosti za dvije skupine. Sagledavajući interesantne segmente rezultata snimanja posture, ekstrahovani su sljedeći rezultati koji imaju izvjesnu statističku značajnost na razini $p \leq 0,05$.

Tablica 2. Rezultati za djecu iz ruralne i urbane sredine

Varijable	Ruralna sredina		Urbana sredina		T- test
	Mean	Std. Deviation	Mean	Std. Deviation	
Tjelesna visina	138.818	8.102	137.351	10.016	.044
Tjelesna težina	30.969	7.944	33.111	8.904	.186
Shoulder displacement	.617	.954	.419	.959	.281
Pelvic obliquity	.088	.331	.120	.412	.655
Shoulder obliquity	-1.319	5.939	-1.593	5.634	.805
Pelvic rotation	-.472	6.876	-1.352	6.446	.490
Trochanter rotation	-.218	7.159	-2.710	7.478	.038
Condylus rotation	-1.585	5.129	-3.475	4.872	.050
Malleolus rotation	.00000	.000000	.00000	.000000	-
Sag. Distance cervical spine - sacrum	2.487	2.143	1.916	1.890	.141
Sag. Distance thoracic spine - sacrum	-.568	2.094	-.818	1.681	.491
Sag. Distance lumbar spine - sacrum	2.710	1.091	2.256	.945	.022
Varus/Valgus left	1.380	3.120	2.081	2.570	.202
Varus/Valgus right	.740	2.443	2.446	2.899	.001
Flexion/Ext left	-2.350	7.404	-3.521	6.685	.386
Flexion/Ext right	-.636	7.862	.137	7.588	.601
Cervical spine	.229	1.142	-.275	.929	.013
Thoracic spine	.018	.784	-.407	.676	.003
Lumbar spine	-.078	.474	-.203	.340	.113

N = 55; $p \leq .05$

Uvidom u tablicu sa opisnom statistikom za obje skupine djece, vidljivo je da ne postoje velike različitosti između dvaju skupina. Samo istraživanje je koncipirano sa pretpostavkom da ne postoje velike različitosti između djece iz ruralnih i urbanih sredina, u smislu posturalnih kvaliteta, jer se u današnje vrijeme djeca datog uzrasta slično ponašaju i imaju slične kretne navike i općenito životne navike. Ako se konsultiraju studije od prije nekoliko godina, može se ustvrditi da su u tom periodu i periodu prije toga istraživanja pokazivala primjetne različitosti između takvih skupina djece (Jovović, Čanjak., 2014). Sagledavajući navedene rezultate mora se napomenuti da su varijable izražene u različitim mjerama (otkloni u centimetrima a rotacije u stupnjevima). Različitosti su male, kad se zna da su jedini parametri sa nešto nižim koeficijentom signifikantnosti, kao npr. rezultati tjelesnih visina i težina te podaci o odstupanjima za vratni dio kralježnice koji se tumači kao blagi skoliotični otklon u odnosu na vertikalu sa pozicije donjeg dijela kralježnice. Dati rezultat ima samo otklon u drugu stranu (cerv. spine ru. .229 / cerv. spine ur. -.275). Unutar tablice prikazani su i rezultati parcijalnih različitosti sa signifikantnim vrijednostima, vidljive su također male različitosti, posebno za vrijednosti iskazane u supnjevima kod rotacija trochantera, condyla koljenog zgloba i odnosima varusnih / valgusnih osi u istim zglobovima. Veličine otklona distanci od vertikale sa pozicije sacruma za segmente vratnog i grudnog dijela kralježnice u frontalnoj ravni, također imaju slične vrijednosti za obje skupine, te se može ustvrditi da obje skupine imaju blaga skoliotična odstupanja na sličnim razinama. Distanca vrijednosti otklona lumbalno postavljenog repera u odnosu na karakterističnu točku sakralnog dijela kralježnice, pokazuje signifikantnu razliku između skupina (rur. 2.710 / urb. 2.256) sa činjenicom da takve vrijednosti pokazuju blagu naglašenost fiziološke, lumbalne, krivne kralježnice za obje skupine djece. Rezultati istraživanja ukazuju da je najkompleksniji aspekt procjene deformiteta kralježnice upravo analiza zakrivljenosti kičmenog stuba u sagitalnoj ravni, dok su rotacije karlice i analize iz frontalne ravni relativno lagane za procjenu (Kowalski i sur., 2014).

DISKUSIJA

Iz navednih podataka u rezultatima istraživanja statusa posture kod djece iz najurbanije sredine u BiH i relativno ruralne sredine, sa sigurnošću se može ustvrditi da postoje vrlo male razlike u posturalnim kvalitetama između ove dvije skupine ispitanika. Parcijalne različitosti su statistički signifikantne za pojedine varijable iz seta sa točno valoriziranim omjerima odstupanja od nulnih

pozicija pretpostavljenog pravilnog držanja tijela kod snimljene djece. Pravilno držanje tijela djece i omladine predstavlja u današnje vrijeme, globalno promatrajući, veliki izazov (Bubanji i sur., 2012). Takve različitosti su u ovom slučaju minorno bitne za cjelokupni opis nečijeg statusa posture jer u jednom dijelu pokazuju da postoje distancirana odstupanja u lijevu ili desnu stranu, odnosno rotacije zacrtanih osi u smislu varusnog i valgusnog položaja natkoljenice i potkoljenice istraživanih skupina. Kao mogući razlozi ovakvog stanja mogu se tražiti i u činjenici da se djeca se sve manje igraju i upražnjavaju fizičku aktivnost u vidu sportskih igara, a sve veći dio vremena provode u pasivnom položaju, sjedeći ili ležeći (Cvetković & Perić, 2009). Konceptualno gledano cijelo istraživanje je i postavljeno sa premisom da nema bitnih različitosti između takozvane ruralne i urbane djece uzrasta 7 do 10 godina. Po osnovi izračuna statističkih pokazatelja, primjetno je da različitosti postoje ali u malom omjeru i sa malim vrijednostima tako da se sukladno tomu može potvrditi pretpostavka da ne postoje velike različitosti između djece iz ruralnih i urbanih sredina, u smislu posturalnih kvaliteta, testiranih u sadašnje vrijeme, što daje kontemporalnost datoj studiji. Recentnost se ogleda i u potenciranom korištenju suvremene metode detekcije statusa posture na kinematičkoj razini u skladu sa 3D protokolima snimanja i precizne valorizacije podataka.

ZAKLJUČAK

Držanje tijela sa adekvatnom valorizacijom stvarnog stanja nečijeg oblika tijela, je predmet različitih studija, na različitim razinama preciznosti posmatranih odstupanja od takozvanog pravilnog držanja tijela. U ovom istraživanju ostavljen je prostor za diskusiju bez pretpostavke da u današnje doba stvarno postoje strukturalno posturalne razlike između djece iz ruralne i urbane sredine. Naravno mora se napomenuti i to da je „ruralna“ sredina (selo) samo relativan pojam, te da danas nema jasno određenih granica takozvanog urbanog i ruralnog stanovništva. Osnovne različitosti, u ovom slučaju, su minorno bitne za cjelokupni opis nečijeg statusa posture. Postoje signifikantne različitosti u držanju lumbalnog dijela kralježnice (blaga lodroza) ali je ista primjetna u obje skupine djece. U jednom dijelu rezultati pokazuju da postoje distancirana odstupanja kralježnice u lijevu ili desnu stranu (gledano frontalno straga), odnosno rotacije zacrtanih osi u smislu varusnog i valgusnog položaja natkoljenice i potkoljenice istraživanih skupina. Sve u svemu obje grupe se uklapaju u prosjek valoriziranog statusa posture za datu populaciju u ovoj regiji. Uz navedene rezultate potencijalno postoji i znanstveni doprinos istraživanja. Isti

se ogleda u mogućnosti unaprijeđenja jasne i precizne valorizacije tjelesnih nedostataka, uz pomoć suvremenih kinematičkih postupaka, a sa ciljem kreiranja matrice ukupnih rezultata koji govore o statusu posture date populacije. Mogućnosti eventualnog predviđanja trenda nastanka poremećaja posture polazna su osnove za dobijanje direktnih benefita u vidu potencijalnih, individualnih, programa za otklanjanje ili umanjeње snimljenih tjelesnih deformiteta.

REFERENCE

Andrijašević, M. (2009). Upravljanje slobodnim vremenom sadržajima sporta i rekreacije, Upravljanje slobodnim vremenom, sadržajima sporta i rekreacije /Andrijašević, M., (ur.). Zagreb: Kineziološki fakultet Sveučilišta u Zagrebu, 3-15.

Avdić, D. i sar. (2007). Loše držanje tijela-informacije za pacijente. Bosnalijek, Sarajevo.

Bogdanović, Z., Milenković, S. (2008). Prisustvo lošeg držanja tela kod mlađeg školskog uzrasta u zavisnosti od nivoa informisanosti o načinu sedenja. Glasnik Antropološkog društva Srbije, (43), 365-367.

Bubanj, S., Zivkovic, D., Milenkovic, S., Bubanj, R., Stankovic, R., Ciric-Mladenovic, I., ... & Cvetkovic, T. (2012). The incidence of sagittal postural deformities among high school students: preliminary study. Acta Kinesiol, 6(2), 27-30.

Cvetković, N., & Perić, D. (2009). Effects of specific games directed at the prevention of flat feet in pre-school children. Sport-Science & Practice, 1(1), 45-57.

Ćirić, A., Čaušević, D., Bejdić, A. (2015). Razlike posturalnog statusa između dječaka i djevojčica uzrasta 6-9 godina snimljene 3D metodom mjernog instrumenta contemplas. *Homosporticus*, 17(1).

Huddleston, S., Mertersdorf, J., Araki, K. (2002). Physical Activity Behavior and Attitudes towards Involvement Among Physical Education, Health, and Leisure Services Pre-Professionals. College Students Jurnal, 36 (4), 555.

Ilić, D., Drašković, V., Eminović, F., Višnjić, S. (2009). Uticaj sportske edukacije u formiranju posturalnog statusa dece mlađeg školskog uzrasta. Tuzla: Zbornik naučnih i stručnih radova „Sport i zdravlje“.

Jovović, V., Čanjak, R. (2014). Komparativna analiza sagitalnih poremećaja kičmenog stuba mlađih adolescentkinja ruralne i urbane sredine. Banja Luka: Zbornik radova „Antropološki aspekti sporta, fizičkog vaspitanja i rekreacije“.

Kovač, S., Kajmović, H., Rađo, I., & Manić, G. (2014). Trend Projections of Body Deformities Occurrence between the ages of 5 and 12, Metrically Objectified and Estimated by 3D Postural Status Screening. *Homosporticus*, 16(2), 5-13.

Kowalski, I. M., Protasiewicz-Fa, H., Raistenskis, J., & Kiebzak, W. (2014). Objective parallel-forms reliability assessment of 3 dimension real time body posture screening tests. *BMC pediatrics*, 14(1), 221.

Prskalo, I., Barić, A., Badrić, M. (2010). Kineziološki sadržaji i slobodno vrijeme mladih, U: Andrijašević, M. (ur.): Kineziološki sadržaji i društveni život mladih, Zagreb, Kineziološki fakultet Sveučilišta u Zagrebu; 65-71.

Standring, S. (2005). *Gray's Anatomy-The Anatomical Basis of Clinical Practice*. Elsevier Churchill Livingstone.

Effect of combined training (strength and sprint) and advanced age on somatroph hormones in response to supramaximal exercise

Maha Sellami¹, Abderraouf Ben Abderrahaman², Safa Shili², Hanen Djemail²,
Wiem Kebsi¹, Hassane Zouhal¹

¹*Movement, Sport, Health and Sciences laboratory, University of Rennes 2, France*

²*Tunisian Research Laboratory "Sport Performance Optimisation" National Center of Medicine and Science in Sports, Tunis, Tunisia*

INTRODUCTION

Some evidence suggested that decline in anabolic capacity with aging process (Veldhuis et al. 1997) is associated with decline in anaerobic performance (Proctor et al. 1995, Galloway et al. 2000, Hakkinen et al. 1993, Manetta et al. 2002, Meinhardt et al. 2010). These alterations in hormonal status with age depend on several factors such as training status, environment and diet. It is resulted essentially in decrease in GH secretion which reaches the half by the age of 60 years old compared to 20-30 years (Corpas et al. 1993; HO et Hoffman, 1993). Thus, the aim of our study was to determine circulating levels of growth hormone (GH), insulin like growth factor (IGF1), and its binding protein (IGFBP3) in response to a high intense sprint and strength training (HISST) in younger (20yrs.) and middle-aged males (40yrs) and to determine whether a relationship with advanced age during supramaximal exercise.

METHODS

Thirty-eight healthy moderately trained and voluntary men aged (20 and 40yrs) participated in this study. They were randomly divided into four groups according to their age. A young trained group (21.4±1.2 yrs, YT, n=10), a young control group (21.3±1.3 yrs, YC, n=9), aged trained group (40.4±2.1 yrs, AT, n=10) and an aged control group (40.3±1.7 yrs, AC, n=9). Both trained group participated in a high-intensity sprint and strength training program (HISST)

for 13 weeks (4 times/week). Before (P1) and after (P2) HISST, all participants performed the Wingate test (WT). Blood samples were collected at rest, after warm-up (50% VO_{2max}), at the end of WT and during recovery at the 10th minute.

RESULTS

Basal GH, IGF1 and IGFBP3 level increased significantly ($p < 0.005$) in AT after HISST. GH levels reached approaching values to those of YT after HISST (**Fig.1**). In response to warm-up and WT, the response of GH/IGF1 axis increases significantly ($p < 0.005$) in trained group only after HISST. In addition, VO_{2max} and maximal power increased significantly ($p < 0.005$) after HISST in both YT and AT compared to control group YC and AC.

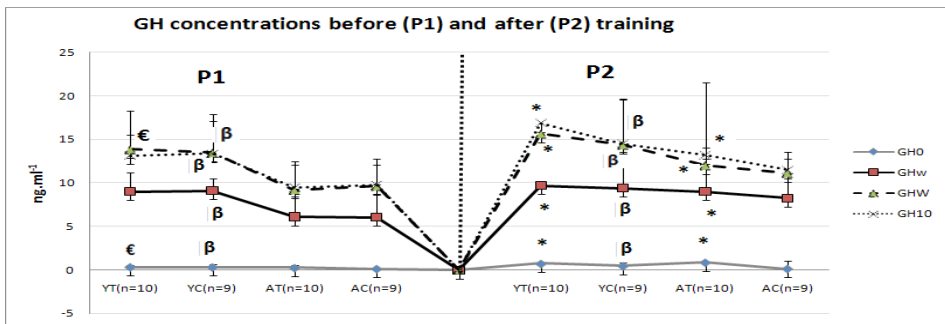

Figure 1. Growth Hormone concentration determined before and after HISST for all groups

Data are means (\pm SD) Plasma GH concentration at rest (GH_0), after warm-up (GH_w), at the end of exercise (GH_w) and during recovery (GH_{10}): Significant differences from before and after HISST, *: $p < 0.05$; €: Significant differences between YT and AT, €: $p < 0.05$; β : Significant differences between YC and AC, β : $p < 0.05$.

DISCUSSION

HISST induced a significant increase in plasma GH, IGF1 and IGFBP3 concentrations at rest and in response to WT in middle-aged group. Our findings are in accordance with some recent studies which had demonstrated that intense training improve basal GH values in young and adult male (Maestu et al. 2003; Wahl et al. 2010, Schmiky et al. 2012, Eliakim et al. 1996). We supposed that the elevation in GH production with training in trained subjects is mainly due to regulation of the processes of GH production or disappearance which depends on several metabolic and hormonal factors.

CONCLUSION

In Abstract, high intensity combined training (sprint and strength) have increased short-term exercise physical performances and the secretion activity of the GH, IGF1 and IGFBP3 in middle-aged trained subjects. Increase in anabolic hormones production with training resulted probably to neural, metabolic, hormones' adaptation to HISST. Additional research is required to clarify the potential utility of these mechanisms to counteract negative effect of ageing.

REFERENCES

- Corpas E, Harman SM, Blackman MR (1993). Human growth hormone and human aging. *Endocr Rev.*, 14: 20–39.
- Eliakim A, Brazel J, Mohan S, Barstow TJ, Berman N, Cooper D (1996). Physical fitness, endurance training, and the GH/IGF-I system in adolescent males and females. *J Clin Endocrinol Metab*, 81: 3986-3992.
- Galloway MT, Jokl P (2000). Aging successfully: the importance of physical activity in maintaining health and function. *J. Am. Acad. Orthop. Surg*, 8(1): 37-44.
- Hakkinen K, Pakarinen A (1993a). Acute hormonal responses to two different fatiguing heavy-resistance protocols in males athletes. *J Appl Physiol*, 74: 882-887.
- Ho K, Hoffman DM (1993). Aging and growth hormone. *Horm Res*, 40:80-86.
- Maestu J, Jurimae J, Jurimae T (2003). Hormonal reactions during heavy training stress and following tapering in highly trained male rowers. *Horm Metab Res*, 35:109-113.
- Manetta J, Brun J, Maimoun L, Callis A, Préfaut C, Mercier J (2002). The effects of training on the GH/IGF-I axis during exercise in middle-aged men: relation to glucose homeostasis. *Am J Physiol Endocrinol Metab*, 283:929-936.
- Meinhardt U; Nelson AE, Hansen LJ; Vita B; David C; Kin-Chuen L, Kenneth GB, Ken KY, Ho MD (2010). The Effects of Growth Hormone on Body Composition and Physical Performance in Recreational Athletes: A Randomized Trial. *Ann Intern Med*, 152(9): 568-577.
- Proctor DN, Sinning WE, Walro JM, Sieck GC, Lemon PW (1995). Oxidative capacity of human muscle fiber types: effects of age and training status. *J Appl Physiol*, 78(6): 2033-8.

Schmikli S, de Vries W, Brink M, Backx F (2012). Monitoring performance, pituitary-adrenal hormones and mood profiles: how to diagnose non-functional over-reaching in male elite junior soccer players. *Br J Sports Med*, 46:1019-1023.

Wahl P, Zinner C, Achtzehn S, Bloch W, Mester J (2010). Effect of high- and low-intensity exercise and metabolic acidosis on levels of GH, IGF1, IGFBP-3 and cortisol. *Growth Horm IGF Res*, 20: 380-385.

Veldhuis, JD., Iranmanesh, A., & Weltman, A. (1997). Elements in the Pathophysiology of Diminished Growth Hormone (GH) Secretion in Aging Humans. *Endocrine*, 7(1): 4148.

Učestalost i topologija boli kod mladih odbojkašica

Nika Stanović, Zoran Grgantov, Jelena Agić, Barbara Gilić

Kineziološki fakultet, Sveučilište u Splitu, Hrvatska

ABSTRACT

The principal objective of this research was to identify the frequency and topology of pain with girls-volleyball players, younger cadets (N = 31, average age = 12.5 years) and cadets (N = 24, average age = 17.4 years). All the players have filled in a modified SEFIP questionnaire. For each of the 15 listed body parts they had to state whether they felt pain and if so, what its intensity was. The obtained results show that cadets feel pain in the shoulder, wrist, fingers, lower back, knee and ankle joint more often than younger cadets. It can be assumed that such results are due to considerably higher training load at the cadet age (higher number of training sessions a week, a high number of jumps and hits of the ball when smashing, blocking and serving) which obviously is not accompanied by appropriate preparation of the body in order to prevent injuries (proper warming up, improvement of functional stability and mobility of the locomotor system, reduction of subcutaneous fat tissue, etc.). It can, therefore, be recommended that during the training process the volleyball trainers should pay much more attention to that aspect of training.

Key words: Youth female players, junior female players, SEFIP questionnaire, analysis of differences

UVOD

Odbojka je sport koji obiluje brzinom i svestranim pokretima tijela pa se od igrača očekuju brze reakcije, sabranost i trenutna snalažljivost. Osnovi tehničko-taktički elementi u odbojci su: servis, prijem servisa, dizanje za smeč, smeč, zaštita smeča, blok i obrana polja. Kod početnika u odbojci od odbo-

jkaških tehnika dominiraju vršno i podlaktično odbijanje te donji (školski) servis. S godinama uče se i zahtjevnije odbojkaške tehnike: vršno odbijanje u skoku, smečiranje, blokiranje, razna prizemljenja (poluupijači, povaljke, rolanja) itd.

Logično je da se uvođenjem intenzivnijih i zahtjevnijih vježbi povećava i vjerojatnost ozljeda za vrijeme treninga, a naročito tijekom natjecanja (Bahr, R. i Bahr, I.A., 1997; Agel i sur., 2007; Sattler, 2011). Odbojkaški elementi koji su najrizičniji u odnosu na mogućnost ozljede su smeč i blok (Watkins i Green, 1992; Agel i sur., 2007). Više od 1/3 djece školske dobi doživi ozljedu dovoljno ozbiljnu da moraju potražiti pomoć liječnika (Adirim i Cheng, 2003). Fizičke i fiziološke razlike koje djecu, u odnosu na odrasle čine "ranjivijima" kada su ozljede u pitanju posljedica su veće površine u odnosu na masu tijela, proporcionalno veće glave, nedovršenog procesa okoštavanja, rnedovojlno razvijenih nekih motoričkih sposobnosti i sl.

Zbog svega gore navedenog, mora se vrlo ozbiljno pristupiti ovoj problematici kako bi se učestalost ozljeda kod djece što više smanjila. Osim sustavnog svakodnevnog programa prevencije koji se treba provoditi, važno je imati i brzu i pouzdanu povratnu informaciju o pojavi boli (lokaciji i intenzitetu) kod mladih sportaša. Jednostavan, brz i pouzdan način prikupljanja informacija o pojavi boli su upitnici provjerenih mjernih karakteristika. Jedan od takvih upitnika je i SEFIP (*Self-Estimated Functional Inability because of Pain*) koji se isključivo do sada koristio na uzorku plesača (Miletić i sur., 2009; Miletić i sur., 2011), a za potrebe ovog istraživanja je prilagođen za odbojku.

Brojna su istraživanja koja analiziraju ozljede u odbojci odnosno njihovu učestalost, lokaciju, mehanizam nastanka i sl. (Watkins i Green, 1992; Bahr, R. i Bahr, I.A., 1997; Agel i sur., 2007; Tsiganos i sur., 2007; Sattler, 2011). Nedostatke takvih istraživanja iznosi Bahr (2009). Autor ukazuje na manjkavost jednog prilikom prikupljanja podataka naročito kada su u pitanju kronične ozljede te predlaže višekratno uzimanje podataka valjanim i osjetljivim instrumentom koji bi u obzir uzimao ne samo pojavu ozljeda, već i pojavu boli i ostalih važnih simptoma koji mogu prethoditi ozljedi. Autor također sugerira da se težina ozljede ubuduće ne mjeri vremenom koje je proteklo do početka ponovnog treninga sportaša, nego do povratka njegove potpune funkcije. Isti autor također upozorava na nužnost jednoznačnog definiranja sportske ozljede. Pod sportskom ozljedom treba se evidentirati svaka pritužba sportaša na njegovo fizičko stanje, a koja se dogodila za vrijeme treninga ili natjecanja, bez obzira je li sportaš:
a) *Mogao nastaviti s treningom ili natjecanjem bez da mu se pruža medicinska po-*

moć; b) *Mogao nastaviti s treningom ili natjecanjem tek nakon što mu je pružena medicinska pomoć*; c) *Nije mogao nastaviti s treningom ili natjecanjem određeno vrijeme*.

Međutim, većina istraživanja u obzir uzimaju samo ovu posljednju skupinu sportskih ozljeda i onda analiziraju njihov nastanak, vrijeme potrebno za oporavak i sl. Taj pristup je posebno upitan u sportovima u kojima prevladavaju kronične ozljede. Može se reći da je odbojka jedan od takvih sportova, jer se i u odbojci mnogo puta tijekom treninga izvode određeni pokreti koji mogu uzrokovati kronične ozljede (udarci po lopti, doskoci). Zbog čestih doskoka u odbojci su česte kronične ozljede donjeg dijela leđa i koljena, a zbog velikog broja udaraca po lopti prilikom smečiranja i serviranja kronične ozljede ramena. Kod kroničnih ozljeda sportaš u dužem vremenskom razdoblju trpi bol. Ta bol može trajati i godinama. Nažalost ponekad sportaši prekidaju s treninzima tek kada ta bol postane toliko intenzivna da uopće ne mogu trenirati, a treninzima se vraćaju čim bol postane podnošljiva. Uobičajenom metodologijom evidentirati će se samo dio tog dugog razdoblja u kojem odbojkaš uopće nije trenirao i natjecao se. Da bi potvrdio svoje hipoteze Bahr (2009) je na uzorku od 115 odbojkašica i odbojkaša koji nastupaju na svjetskim turnirima u odbojci na pijesku primijenio dvije različite metode prikupljanja podataka. Prvo je metodom strukturiranog intervjua prikupio podatke o ozljedama ispitanika u protekla 2 mjeseca. Pritom su kao ozljede tretirane one zbog kojih se propustio barem 1 trening ili natjecanje. Zatim je ispitanicima podijelio upitnik s pitanjima koja su se odnosila na kronične ozljede (pojavu boli) u području ramena, donjeg dijela leđa i koljena. Dvema primjenjenim metodama dobiveni su bitno drugačiji rezultati. Odbojkašice i odbojkaši na pijesku su prijavili ukupno 26 ozljeda u protekla 2 mjeseca. Oko 20% ispitanika je prijavilo ozljedu. S druge strane gotovo 49% ispitanika je 2 mjeseca prije istraživanja prijavilo bol u jednom od 3 anketirana dijela tijela (rame, donji dio leđa, koljeno), 28% u 2 od 3, a 6% u sva 3 dijela tijela. Samo 17% igrača nije prijavilo bol u proteklom razdoblju. Ta ogromna razlika u postocima dobivena dvjema različitim metodama (20% naprema 83%) potvrđuje ispravnost autorovih tvrdnji o nužnosti drugačijih metodoloških pristupa ovoj problematici.

Zbog svega gore navedenog nameće se i primarni cilj ovog istraživanja: utvrditi učestalost boli kod odbojkašica mlađih kadetkinja i kadetkinja. Poseban cilj je utvrditi postoje li značajne razlike u učestalosti boli između te dvije grupe odbojkašica.

METODE RADA

Uzorak ispitanica u ovom istraživanju predstavlja 55 odbojkašica (31 mlađa kadetkinja i 24 kadetkinje) iz Splita. Osnovna obilježja dviju podskupina odbojkašica prikazane su u tablici 1.

Sve ispitanice popunile su modificirani SEFIP upitnik. Uvažavajući specifičnosti odbojke, dijelovi tijela u kojima se evidentira pojava boli su nešto izmijenjeni. Ispitanice su za svaki od 15 dijelova tijela (vrat, rame, lakat, zglobovi šake, prsti na ruci, gornji dio leđa, donji dio leđa, kuk, natkoljenica sprijeda, natkoljenica natrag, koljeno, potkoljenica sprijeda, potkoljenica natrag, skočni zglob, stopalo) trebali odgovoriti da li osjećaju bol i kojeg je ona intenziteta. Za sve dijelove tijela na rukama i nogama ispitanici su popunjavali i za lijevu i za desnu stranu. Ponuđeni su odgovori na likertovoj skali sa sljedećim ocjenama: 0 – uopće me ne boli; 1 - malo me boli; 2 – dosta me boli, ali treniram; 3 – jako me boli pa izbjegavam određene pokrete; 4 – ne mogu uopće trenirati zbog boli. Za potrebe ovog istraživanja koristit će se nominalna skala – “ima boli” : “nema boli” u pojedinoj regiji.

Analizom varijance istraživana je značajnost razlika između odbojkašica mlađih kadetkinja i kadetkinja obzirom na njihovu dob, tjelesnu visinu, tjelesnu masu, godine treniranja i tjedne sate treniranja.

Hi-kvadrat testom analizirana je značajnost razlika u učestalosti boli u pojedinim dijelovima tijela između odbojkašica mlađih kadetkinja i kadetkinja.

REZULTATI I RASPRAVA

U tablici 1. prikazane su osnovna obilježja uzorka ispitanica.

Tablica 1. Osnovna obilježja uzorka (prosječne vrijednosti)

	Dob		Tjelesna Visina	Tjelesna masa	Godine treniranja	Tjedni sati treninga
Mlađe kadetkinje N=31	12,5	161,6	46,4	2,4	2,7	
Kadetkinje N=24	17,4	178,6	64,3	5,9	7,7	
p	0,000		0,000	0,000	0,000	0,000

Uvidom u tablicu 1. može se zaključiti da su razlike u svim izmjerenim varijablama (dob, tjelesna visina, tjelesna masa, godine treniranja i tjedni sati tren-

inga) statistički značajne. To znači da se pri objašnjavanju eventualnih razlika u učestalosti boli u pojedinim dijelovima tijela ne smije isključiti mogući utjecaj ni jedne od gore navedenih varijabli.

U tablici 2. vidljiva je relativna vrijednost učestalost boli te značajnost razlika između dvije definirane podskupine kod mladih odbojkašica.

Tablica 2. Učestalost boli (u postotcima) u pojedinim dijelovima tijela kod odbojkašica mladih kadetkinja i kadetkinja te značajnost razlika dobivenih Hi-kvadrat testom

LOKACIJA BOLI	MLAĐE KADETKINJE (%)	KADETKINJE (%)	Hi-kvadrat
VRAT	19,4	8,3	0,250
RAME	19,4	58,3	0,003
LAKAT	6,5	12,5	0,439
ZGLOB ŠAKE	6,5	29,2	0,024
PRSTI RUKE	3,2	25	0,016
GORNJI DIO LEĐA	16,1	25,0	0,415
DONJI DIO LEĐA	12,9	58,3	0,000
KUK	3,2	16,7	0,08
NATKOLJENICA (SPRIJEDA)	0,0	8,3	0,10
NATKOLJENICA (NATRAG)	0,0	8,3	0,10
KOLJENO	12,9	37,5	0,033
POTKOLJENICA (SPRIJEDA)	0,0	4,2	0,251
POTKOLJENICA (NATRAG)	6,5	4,2	0,711
SKOČNI ZGLOB	3,2	29,2	0,007
STOPALO	6,5	0,0	0,21

Najučestalija mjesta boli prijavljena od strane mladih kadetkinja su: vrat (19,4%), rame (19,4%) te gornji dio leđa (16,1%). Može se pretpostaviti, obzirom da treninzi kod mladih kadetkinja nisu intenzivni, da ti simptomi nisu posljedica velikih trenažnih opterećenja. Autor pretpostavlja da se radi o bolovima koji su posljedica sedentarnog načina života jer su to tipične regije u kojima se javlja bol kod osoba koje dugo sjede. U protivnom, mlađe kadetkinje bi znatno češće prijavljivale bol u dijelovima tijela koji su posebno osjetljivi na veća fizička opterećenja (donji dio leđa, koljeno, skočni zglob) što u ovom istraživanju nije bio slučaj. Za razliku od mladih kadetkinja, kadetkinje su najčešće pri-

javljivale bol u ramenu i donjem dijelu leđa (58,3%), zatim koljenu (37,5%) te skočnom zglobu i zglobu šake (29,2%).

Ti postoci su vrlo visoki i zabrinjavajući. Očito je da na prijelazu iz mlađe kadetske u kadetsku dobnu skupinu postoji naglo povećanje trenažnih opterećenja u vidu povećanog tjednog fonda sati treninga (tablica 1), ali se može pretpostaviti da su i ti treninzi intenzivniji i zahtjevniji kako se sve više uvode u trening smeč, blok, lelujavi i skok servisi i razna prizemljenja. Bolovi u ramenu, donjem dijelu leđa i koljenu najčešće su kroničnog tipa (sindrom prenaprezanja). Međutim, dobro utrenirana mlada sportašica trebala bi biti spremna za ta povećana opterećenja. Očito je da se u treningu mladih odbojkašica nedovoljno pažnje posvećuje poboljšanju funkcije tj. pripremi lokomotornog sustava za te povećane napore.

Važno je od samih početaka bavljenja sportom djelovati na funkcionalnu mobilnost i stabilnost mišića trupa te velikih skupina mišića oko zgloba kuka i ramena (podjednako na lijevoj i desnoj strani te na prednjoj i stražnjoj strani tijela). Paralelno s uravnoteženim programom za razvoj jakosti i pokretljivosti miškulature, treba posvetiti veliku pažnju usvajanju pravilne tehnike svih pokreta koji se na treninzima uvježbavaju, jer nepravilna tehnika uvijek povećava rizik od ozljeda. Kada bi se sve te aktivnosti sustavno provodile sigurno bi se znatno smanjila učestalost kronične boli u tim regijama. Ako se velika učestalost boli u ramenu, donjem dijelu leđa i koljenu kod kadetkinja može u većini slučajeva objasniti nesrazmjerom između pripremljenosti lokomotornog aparata i trenažnih opterećenja, bolovi u šaci, prstima na ruci i u predjelu skočnog zgloba su najčešće akutne prirode. Značajno veća učestalost boli u tim regijama kod kadetkinja očito je posljedica mnogo većeg broja izvođenja smečeva, blokova i prizemljenja na njihovim treninzima. Najčešća akutna ozljeda u odbojci je distorzija skočnog zgloba (Bahr i sur., 1994; Bahr i Bahr, 1997; Agel i sur., 2007; Sattler 2011) do koje u najvećem broju slučajeva dolazi doskokom na stopalo protivničkog igrača nakon izvedenog bloka i smeča. Isti autori ukazuju da su i bolovi u šaci i prstima ruke također najčešće akutnog tipa i nastaju kontaktom lopte s tim dijelovima tijela prilikom blokiranja ili obrane polja.

ZAKLJUČAK

Odbojkašice kadetkinje značajno češće prijavljivale su bol u području ramena, zgloba šake, prstiju na ruci, donjeg dijela leđa, koljena i skočnog zgloba. Svakako da više godina treniranja i veći fond tjednih sati treninga kod kad-

etkinja utječe na dobivene razlike, kao i dominacija intenzivnih odbojkaških elemenata (smeč, blok i snažni servisi) na treningu i natjecanju u kadetskoj dobnoj skupini.

Međutim, sustavan tehnički i kondicijski trening trebao bi pripremiti mlade odbojkašice na postepeno povećanje zahtjeva koje treninzi i natjecanja u kadetskoj, a pogotovo u juniorskoj i seniorskoj dobi iziskuju. Očito je da odbojkašice u ovom slučaju nisu bile adekvatno pripremljene na povećane trenažne i natjecateljske napore što je rezultiralo i velikom učestalošću boli u pojedinim dijelovima tijela.

Primjena standardiziranih upitnika za procjenu boli trebala bi imati vrlo važno mjesto u trenažnom procesu. Ti upitnici omogućavaju trenerima (sportskim fizioterapeutima, liječnicima) brzo prikupljanje korisnih informacija o mjestu i intenzitetu boli kod sportaša. Te informacije moraju se uvažavati na način da se kod sportaša koji su prijavili bol (bez obzira na intenzitet) mora pronaći uzrok boli. To je vrlo važno, jer djelovanje na posljedicu (bol) bez da se ustanovi pravi uzrok nastanka boli, u pravilu ne donosi dobre rezultate. Npr. vrlo često bol u koljenu uzrok ima u nedovoljnoj snazi pojedinih mišića u zglobu kuka, bol u ramenu je posljedica neadekvatne jakosti i pokretljivosti muskulature ramenog obruča, a njenom nastanku mogu pridonjeti i drugi čimbenici kao što su neadekvatno zagrijavanje, nepravilna tehnika pokreta, korištenje prevelikih vanjskih opterećenja itd. Vrlo često bol je uzrokovana kombinacijom nekoliko čimbenika što svakako otežava njihovo otkrivanje i zahtijeva suradnju čitavog stručnog tima (trener, kondicijski trener, fizioterapeut, liječnik...). Čak je i kod najmanjeg intenziteta boli ("malo me boli") uputno izbjegavati određene pokrete koji izazivaju bol, te smanjiti volumen i intenzitet treninga uz odgovarajuću terapiju. Kod prijave boli većeg intenziteta, a ovisno o uzroku boli, treba biti još oprezniji i provoditi terapiju koja može imati cilj jačanje ili istežanje određenih dijelova tijela ili pak principom "RICE" – rest, ice, compression, elevation (odmor, hlađenje, stežanje, podizanje na povišenje) ili nekim drugim metodama (npr. ultrazvuk, laser) ublažiti negativne posljedice ozljede kako bi sportaš što prije mogao ponovno trenirati i natjecati se maksimalnim intenzitetom.

U narednim istraživanjima trebalo bi višekratno evidentirati pojavu boli SE-FIP upitnikom. Na taj način dobila bi se saznanja o promjenama u učestalosti i intenzitetu boli tijekom vremena što bi se onda moglo dovoditi u vezu s raznim postupcima koji su se na treningu i natjecanju provodili s ciljem prevencije pojave boli te detaljnije analizirati "mehanizme" nastanka boli (kronična ili akutna, u kakvim okolnostima se pojavila, koliko je treninga izostao zbog te boli i sl.

LITERATURA

Adirim, T.A., & Cheng, T.L. (2003). Overview of injuries in the young athlete. *Sports Medicine*, 33(1),75-81

Agel, J., Palmieri-Smith, R.M., Dick, R., Wojtys, E.M., & Marshall, S.W. (2007). Descriptive Epidemiology of Collegiate Women's Volleyball Injuries: National Collegiate Athletic Association Injury Surveillance System, 1988–1989 Through 2003–2004. *Athletic training*, 42(2), 295-302.

Bahr, R. (2009). No injuries, but plenty of pain? On the methodology for recording overuse symptoms in sports. *British Journal of Sports Medicine*,43(13), 966-972.

Bahr, R, & Bahr, I.A. (1997). Incidence of acute volleyball injuries: a prospective cohort study of injury mechanisms and risk factors. *Scandinavian Journal of Medicine & Science in Sport*, 7(3), 166-171.

Bahr, R., Andersen, S.O., Loken, S., Fossan, B., Hansen, T., & Holme, I. (2004). Low back pain among endurance athletes with and without specific back loading—a cross-sectional survey of cross-country skiers, rowers, orienteers, and nonathletic controls. *Spine* 29(4), 449-454.

Miletić, A., Kostić, R., & Miletić, Đ. (2011). Pain Prevalence Among Competitive International Dancers. *International journal of Athletic Therapy & Training* 16 (1), 13-16

Miletić, A., Kostić, R., & Božanić, A., & Miletić, Đ. (2009). Pain Status Monitoring in Adolescent Dancers. *Medical problems of performing artists* 24(7), 119-124.

Sattler, T. (2011). Intrinsic risk factors for sport injuries in female volleyball *British Journal of Sports Medicine*; 45, 533-534

Tsigganos, G., Beneka, A., Malliou, P., Gioftsidou, A., Zetou, H., & Godolias, G. (2007). *Is the incidence in volleyball injuries age related? A prospective study in greek male volleyball players.* Physical training.

Watkins, J., & Green, B.N. (1992). Volleyball injuries: a survey of injuries of Scottish National League male players. *British Journal of Sports Medicine*, 26(1), 135-137

Učestalost i topologija boli kod mladih odbojkašica i rukometašica

Karla Magzan¹, Zoran Grgantov¹, Maja Gelo¹, Ljubomir Pavlović²

¹Kineziološki fakultet, Sveučilište u Splitu, Hrvatska

²Fakultet sporta i fizičkog vaspitanja, Univerzitet u Nišu, Srbija

ABSTRACT

The authors used a modified SEFIP questionnaire to determine the frequency and topology of pain on a sample of 63 female subjects (30 volleyball players, and 33 handball players with an average age of 13,7). Young volleyball players in the most of the cases reported pain in their lower back (50%), then knee pain (36,3%) and lower back pain (33,3%). Unlike them young handball players have knee pain in most of the cases (62,7%), upper back pain (45,5%) and finally shoulder and wrist pain (39,4%). Based on the results from the Chi-square test it can be concluded that handball players reported neck, shoulder, knee and foot pain significantly more often than volleyball players. Further research is necessary to determine the real cause of those differences. It can be assumed that the differences are the result of longer participating in sport in the case of handball players compared to volleyball players (5 years: 2,6 years). Also there are obvious differences in these two sports (eg. possibility of contact with an opponent) that significantly contribute to such result.

Key words: volleyball, handball, SEFIP questionnaire, Chi-square test

UVOD

Odbojka i rukomet su kolektivne sportske igre i bez obzira na kompleksnost i različitost, ozljede su nažalost sastavni dio oba sporta. Iako odbojka nije kontaktni sport, velik broj skokova i doskoka prilikom smečiranja, blokiranja i serviranja, zatim snažni udarci po lopti i brze promjene pravca kretanja, mogu uzrokovati ozljedu.

Cassell (2001) u preglednom članku navodi da je skočni zglobov u prosjeku najčešće ozljeđivan dio tijela u odbojci (raspon od 17% do 61%), pa prsti ruku (8-45%), koljeno (6-59%), rame (2-24%) i leđa (9-18%). Širok raspon u postocima autor objašnjava razlikama u veličini, spolu i dobi uzorka ispitanika, definiranju ozljeda i načinu prikupljanja podataka (anketiranje sportaša, podaci iz bolnica ili klinika itd.) u analiziranim istraživanjima.

U dvjema velikim studijama koje su istraživale ozljede školske djece u Švicarskoj (De Loes 1995) i Njemačkoj (Backx i sur. 1991) ustanovljeno je da je učestalost ozljeda u odbojki manja u odnosu na druge sportske igre (nogomet, košarku i rukomet).

Bahr i sur. (1994) su uspoređivali učestalost ozljeda u odbojki s ozljedama u drugim sportskim igrama. Zaključili su da je učestalost ozljeda u odbojki (1,7 ozljeda na 1000 sati treninga i natjecanja) nešto manja od učestalosti u košarci (2,5 ozljeda na 1000 sati treninga i natjecanja), a znatno manja u odnosu na nogomet (8,6 ozljeda na 1000 sati treninga i natjecanja) i rukomet (8,3 ozljede na 1000 sati treninga i natjecanja).

I u rukometu, tijekom treninga i natjecanja, igrači izvode brojne skokove, doskoke, promjene brzine i smjera kretanja, šuteve na gol, prizemljenja itd. Velik broj tih akcija odigrava se u direktnom kontaktu s protivnikom koji može dodatno povećati rizik od ozljeda.

Reckling i sur. (2003). Su na uzorku od 100 mladih igrača (50 rukometašica i 50 rukometaša), u dobi od 12 do 18 godina, primjenili standardizirani upitnik s ciljem prikupljanja podataka o vrsti i učestalosti ozljeda. Evidentirali su ukupno 130 ozljeda kod 73 ispitanika. Najviše ozljeda (73%) dogodilo se između 15 i 18 godine. Više od 2/3 ozljeda dogodile su se tijekom natjecanja. Najveći postotak ozljeda je zabilježen u području skočnog zgloba (32%), prstiju na ruci (27%) i koljenu (25%). Najteže ozljede su pri tome bile ozljede koljena i to najčešće ozljede prednjeg križnog ligamenta. Pri tome se čak 11 od 12 ruptura prednjeg križnog ligamenta dogodilo u dobi između 15 i 18 godine. Autori upozoravaju na mogući nesrazmjer snage i koordinacije u toj dobnoj skupini što treba uvažavati u treningu i natjecanju..

Prva istraživanja pojave boli standardiziranim upitnikom su se provodila na uzorku radnika različitih zanimanja (Kourinka i sur., 1987) i to upitnikom „*Nordic Musculoskeletal Questionnaire (NMQ)*“. Taj upitnik je do današnjih dana jedan od najkorištenijih u području medicine rada. Izvorni NMQ upitnik za potrebe sporta prilagođavali su različiti autori. Danas najčešće primjenjivani upitnik koji je nastao na platformi NMQ-a je *SEFIP (Self-Estimated Functional Inability because of Pain)*. Taj upitnik su validirali Ramell i sur. (1999), a korišten je u istraživanjima Miletić i sur. (2009) i Miletić i sur. (2011). *SEFIP* je konstruiran s ciljem evaluacije pojave boli kod plesača i do danas se uglavnom koristio na toj populaciji.

Cilj ovoga rada je utvrditi učestalost i topologiju mišićno-koštane boli kod mladih odbojkašica i rukometašica primjenom modificiranog *SEFIP* upitnika te

utvrditi postoje li značajne razlike u učestalosti boli u pojedinim dijelovima tijela između te dvije skupine sportašica.

METODE RADA

Ukupno 63 ispitanice (30 odbojkašica članica OK Marina Kaštela i 33 rukometašice članice ŽRK Vranjic) sudjelovale su u istraživanju. Detaljnija obilježja ispitanica prikazane su u tablici 1.

Sve ispitanice popunile su modificirani *SEFIP* upitnik. Uvažavajući specifičnosti odbojke i rukometa dijelovi tijela u kojima se evidentira pojava boli su nešto izmijenjeni. Ispitanice su za svaki od 15 dijelova tijela (vrat, rame, lakat, zglob šake, prsti na ruci, gornji dio leđa, donji dio leđa, kuk, natkoljenica sprijeda, natkoljenica natrag, koljeno, potkoljenica sprijeda, potkoljenica natrag, skočni zglob, stopalo) trebali odgovoriti je li osjećaju bol i kojeg je ona intenziteta. Za sve dijelove tijela na rukama i nogama ispitanici su popunjavali i za lijevu i za desnu stranu. Ponuđeni su odgovori na Likertovoj skali sa sljedećim ocjenama: 0 – uopće me ne boli; 1 - malo me boli; 2 – dosta me boli, ali treni ram; 3 – jako me boli pa izbjegavam određene pokrete; 4 – ne mogu uopće trenirati zbog boli.

Za potrebe ovog istraživanja ljestvica je modificirana na nominalnu skalu: osjeća bol – ne osjeća bol.

T-testom istraživana je značajnost razlika između odbojkašica i rukometašica obzirom na njihovu dob, tjelesnu visinu, tjelesnu masu, godine treninga i tjedne sate treninga. Hi-kvadrat testom analizirana je značajnost razlika u učestalosti boli u pojedinim dijelovima tijela između odbojkašica i rukometašica.

REZULTATI I RASPRAVA

U tablici 1. prikazana su osnovna obilježja te značajnost razlika odbokašica i rukometašica koje su uključene u ovo istraživanje.

Tablica 1. Osnovna obilježja odbojkašica i rukometašica (prosječne vrijednosti) i značajnost razlika dobivenih t testom (p)

	Dob	Tjelesna visina	Tjelesna masa	Godine treninga	Tjedni sati treninga
Odbojkašice N=30	13,6	164,4	51,5	2,6	5,5
Rukometašice N=33	13,8	169	57	5	6,1
p	0,645	0,004	0,013	0,000	0,162

Uvidom u tablicu 1. može se zaključiti da između anketiranih rukometašica i odbojkašica postoje značajne razlike u tjelesnoj visini, tjelesnoj masi i godinama treninga (sve u korist rukometašica), ali ne i u dobi i tjednom broju sati treninga. Te razlike moraju se uvažavati prilikom interpretacije dobivenih razlika u učestalosti boli. Obzirom da su rukometašice značajno više i teže te da značajno duže treniraju od svojih vršnjakinja odbojkašica, to sve može utjecati na veću učestalost boli što se mora uvažavati prilikom interpretacije dobivenih rezultata.

U tablici 2. prikazane su učestalosti boli u pojedinim dijelovima tijela kod mladih odbojkašica i rukometašica te njihove razlike.

Tablica 2. Učestalost boli u pojedinim dijelovima tijela kod odbojkašica i rukometašica, te značajnost razlika dobivenih Hi-kvadrat testom

LOKACIJA BOLI	ODBOJKAŠICE (%)	RUKOMETAŠICE (%)	Hi - kvadrat
VRAT	0	33	0,001
RAME	16,7	39,4	0,046
LAKAT	10	21,2	0,224
ZGLOB ŠAKE	20	39,4	0,094
PRSTI RUKE	16,7	21,2	0,646
GORNJI DIO LEĐA	33,3	45,5	0,326
DONJI DIO LEĐA	50	30,3	0,110
KUK	10	12,1	0,789
NATKOLJENICA (SPRIJEDA)	10	15,2	0,54
NATKOLJENICA (NATRAG)	3,3	3	0,945
KOLJENO	36,3	62,7	0,004
POTKOLJENICA (SPRIJEDA)	3,3	9,1	0,349
POTKOLJENICA (NATRAG)	6,7	18,2	0,17
SKOČNI ZGLOB	23,3	36,4	0,260
STOPALO	3,3	21,2	0,033

U tablici 2. prikazana je učestalost boli kod odbojkašica i rukometašica, kao i značajnost razlika u učestalosti boli u pojedinim dijelovima tijela. Mlade odbojkašice u najvećem postotku prijavile su bol u donjem dijelu leđa (50%), zatim koljenu i gornjem dijelu leđa (36,3% odnosno 33,3%). Postotak boli u području

leđa je daleko iznad gornje granice postotka ozljeda u tom dijelu tijela koji su objavili Cassel i sur. (2001) u svom preglednom istraživanju (18%). Također je učestalost boli i u nekim drugim dijelovima tijela (npr. koljeno i rame), u gornjem dijelu raspona rezultata istih autora. Očito je da već i kod mlađih dobnih skupina u odbojci postoji velika učestalost pojave boli koja je vjerojatno najvećim dijelom kroničnog tipa i može prethoditi ozbiljnijim kroničnim ozljedama. To zbog toga što su i u dosadašnjim istraživanjima (npr. Schafle i sur., 1990; Tsiganos i sur., 2007) donji dio leđa, rame i koljeno označeni kao dijelovi tijela "tipični" za kronične ozljede u odbojci. Takav zaključak potvrđuje i manja učestalost boli u dijelovima tijela koji su u odbojci „tipični“ za akutne ozljede (skočni zglob i prsti na ruci) u kojima su mlade odbojkašice bliže donjem dijelu raspona kojeg su objavili Cassell i sur. 2001. Međutim, pomalo iznenađuje relativno velika učestalost boli u zglobu šake (20%). Može se pretpostaviti da velik broj vršnih odbijanja (nedovoljna jakost muskulature na podlaktici) i podlaktičnih odbijanja (povijenost šaka prema podlozi – dorzalna fleksija) koji su karakteristični za mlađe-kadetsku dobnu skupinu u odbojci, to dijelom uzrokuje.

Obzirom da se u odbojci u dobi od 13 do 14 godina ne trenira intenzivno (smećiranje, blokiranje i skok servisi nisu još uvijek dominantni u treningu) i rizik od ozljeda skočnog zgloba (najčešće prilikom doskoka na stopalo protivnika na mreži) i prstiju na ruci (najčešće prilikom blokiranja) je manji nego što je to slučaj kod starijih dobnih skupina. Iz istog razloga može se pretpostaviti da su učestali bolovi u leđima kod mladih odbojkašica prije uzrokovani nedovoljnim kretanjem odnosno dugotrajnim sjedenjem i ležanjem, nego pretjerano intenzivnom kineziološkim angažmanom. A kod djece koja se ne kreću dovoljno i u školi i kod kuće puno sjede, i manje intenzivni odbojkaški elementi mogu utjecati na pojavu boli u osjetljivim regijama tijela.

Za razliku od odbojkašica mlade rukometašice u najvećem postotku osjećaju bol u koljenu (čak 62,7%), gornjem dijelu leđa (45,5%) te ramenu i zglobu šake (39,4%). Na osnovu rezultata Hi-kvadrat testa može se zaključiti da od svih navedenih dijelova tijela, rukometašice značajno češće osjećaju bol u vratu, ramenu, koljenu i stopalu od odbojkašica, dok su i u većini ostalih regija tijela rukometašice češće prijavljivale bol od odbojkašica, ali te razlike nisu statistički značajne.

Očito je da su vrat, gornji dio leđa i gornji ekstremiteti više opterećeni u mladih rukometašica u odnosu na odbojkašice. Šutevi na gol uz istovremeni kontakt protivnika, ali i obrambeni kontakti s protivničkim napadačicama ili s loptom, koji ponekad rezultiraju i padovima na ruke ili rame, vjerojatno uzrokuju te razlike. I u koljenu mlade rukometašica češće prijavljuju bol u usporedbi

s mladim odbojkašicama: Može se pretpostaviti da su uzrok tome češći udarci u koljeno u rukometu bilo prilikom kontakta s protivnikom u duel igri, bilo prilikom kontakta s podlogom prilikom prizemljenja.

Bol u koljenu može se javiti i zbog nedovoljna jakost miškulature i to prvenstveno miškulature koja okružuje zglob kuka. Naime, ako mišići koji stabiliziraju i opružaju zglob kuka (glutealna skupina mišića) ne obavljaju svoju funkciju kako bi trebali, značajno se povećava opterećenje na koljenu zglob u kojem se počinju javljati pokreti torzije za koje taj zglob nije „dizajniran“. Posljedica su kronične (npr. skakačko koljeno) i akutne ozljede (kod žena su vrlo česte ozljede prednjih križnih ligamenata). Za razliku od odbojke u kojoj još uvijek kod mlađih kadetkinja u treningu nema mnogo rizičnih aktivnosti za zglob koljena, u rukometu ima naglih ubrzanja, zaustavljanja i promjena smjera, kao i doskoka i prizemljenja nakon kontakta s protivničkim igračicama. Kod svih tih akcija tijelo mora generirati, kontrolirati i apsorbirati velike sile za koje mladi organizam u fazi ubrzanog rasta i razvoja često nije adekvatno pripremljen. Stoga se može pretpostaviti da je značajno veća učestalost boli u koljenom zglobovu kod rukometašica uzrokovana dijelom i razlikama između ova 2 sporta, a dijelom ta razlika može biti posljedica i značajno dužeg „sportskog staža“ te veće tjelesne visine i tjelesne mase kod rukometašica (tablica 1).

I bolovi u stopalu mogu biti posljedica slabo razvijene miškulature zgloba kuka. Naime, ako je glutealna skupina mišića slaba, onda se natkoljenica rotira prema unutra, a to za posljedicu ima i pronaciju stopala. Pronacija stopala vremenom za posljedicu ima spuštanje svodova stopala (ravna stopala). Takva stopala ne mogu dobro amortizirati sile koje se javljaju prilikom trčanja, promjena pravca kretanja, doskoka itd. Posljedica je bol koja je češća u rukometu jer te pokrete, kako je prije navedeno, mlade rukometašice na treninzima i utakmicama mnogo češće izvode od svojih vršnjakinja odbojkašica.

ZAKLJUČAK

Mlade rukometašice značajno češće osjećaju bol u vratu, ramenu, koljenu i stopalu od odbojkašica, dok su i u većini ostalih regija tijela rukometašice češće prijavljivale bol od odbojkašica, ali te razlike nisu statistički značajne.

Prikupljanje informacija o pojavi boli kod sportaša treba biti samo prvi korak u detaljno isplaniranom skupu postupaka koji za cilj imaju djelovanje na smanjenje broja i težine ozljeda u sportu.

Ovo istraživanje je potvrdilo da se bol javlja i kod mladih odbojkašica, a naročito rukometašica koje su tek počele sportsku karijeru. Već i prijavu boli

najmanjeg intenziteta treba ozbiljno uzeti u razmatranje, a pogotovo ako se radi o boli većeg intenziteta koja traje duže vrijeme.

Treneri su osobe koje bi trebale najbolje poznavati mogućnosti svake sportašice koju treniraju. Njihova je zadaća da podučavanjem pravilne tehnike pokreta, pravilnom kondicijskom pripremom, pravilnom izmjenom rada i odmora, kvalitetnim zagrijavanjem u uvodnom dijelu i opuštanjem u završnom dijelu treninga, djeluju preventivno na pojavu boli i ozljeda. A ako se bol pojavi, trebaju odmah adekvatno reagirati.

SEFIP upitnik, obzirom da ne sadrži pitanja o pojavi boli u prošlosti već samo trenutno stanje, je pogodan za višekratno prikupljanje podataka. Na taj način bi se dobili korisni podaci o tome da li se reakcijom na pojavu boli uspješno bol smanjiti (olakšati), anulirati ili se pak ona pojačala, a mogle bi se utvrditi i relacije između pojave boli i eventualnih ozljeda u budućnosti. U ovom istraživanju nije evidentiran način nastanka ozljeda (kontakt s protivnikom, kontakt s loptom, doskok isl.) pa se o uzrocima razlika može samo pretpostavljati; u uzorku su bile samo odbojkašice i rukometašice mlađe kadetkinje. Također bi u narednim istraživanjima bilo zanimljivo provesti slično istraživanje i na odbojkašicama i rukometašicama starijih dobnih skupina, pri tome uzimajući u obzir i specifičnosti pojedinih igračkih uloga.

LITERATURA

Backx, F.J.G., Beijer, H.J.M., & Bol, E. (1991). Injuries in high-risk persons and high-risk sports. *American Journal of Sports Medicine*, 19(2), 124-128.

Bahr, R., Lian, O., Karlsen, R., & Ovreber, R.V. (1994). Incidence and mechanism of acute ankle inversion injuries in volleyball ~ a retrospective cohort study. *American Journal of Sports Medicine*, 22(5), 595-600.

Cassell, E. (2001). Spiking injuries out of volleyball: a review of injury countermeasures. *Monash university accident research centre report No. 181*.

De Loes, M. (1995). Epidemiology of sports injuries in the Swiss organisation "Youth and Sports" 1987-1989. *Int J Sports Med*. 16:134-138.

Kuorinka, I, Jonsson, B, Kilbom, A., Viteberg, H., Biering- Sorensen, F., Andersson, G., & Jorgensen, K. (1987). Standardized Nordic questionnaires for the analysis of musculoskeletal symptoms. *Applied Ergonomics*, 18(3), 233-237.

Miletić, A., Kostić, R., & Miletić, Đ. (2011). Pain Prevalence Among Competitive International Dancers. *International journal of Athletic Therapy & Training*, 16 (1), 13-16

Miletić, A., Kostić, R., & Božanić, A., & Miletić, Đ. (2009). Pain Status Monitoring in Adolescent Dancers. *Medical problems of performing artists*, 24(7), 119-124.

Ramel, E.M, Moritz, U., & Jarnlo, G.B. (1999). Validation of a pain questionnaire (SEFIP) for dancers with a special created test battery. *Medical Problems of Performing Artists*, 14(4),196-203

Reckling, C., Zantop, T. & Petersen W. (2003). Sportverletzung Sportschaden. *Organ der Gesellschaft fur OrthopadischTraumatologische Sportmedizin*, 17(3), 112-117

Schafle, M.D., Requa, R.K., Patton, W.L., & Garrick, J.G. (1990). Injuries in the 1987 National Amateur Volleyball Tournament. *American Journal of Sports Medicine*, 18(5), 624-631.

Tsigganos, G., Beneka, A., Malliou, P., Gioftsidou, A., Zetou, H., & Godolias, G. (2007). *Is the incidence in volleyball injuries age related? A prospective study in greek male volleyball players*. Physical training.

Relacije socio-demografskih karakteristika i razloga za vježbanje polaznica zumba fitness programa

Jerko Cvitanić, Mia Perić, Dragana Olujić

Kineziološki fakultet, Sveučilište u Splitu, Hrvatska

ABSTRACT

Why one engages in specific types of exercise has been examined by the means of a PIEQ questionnaire. The research was designed with the aim of determining the relation between sociodemographic characteristics and the reasons for taking up zumba programme. The sample consisted of a zumba programme attendants (N=51), of the average age 36.58 ± 12.81 that had been attending the programme for two years on average. The variables included a PIEQ questionnaire (Personal Incentives For Exercise Questionnaire) and a questionnaire on general information about life habits. Four factors, four reasons for taking up exercise were separated through factor analysis, while correlation established the relation between the participants' experience in exercising and factor variables. Results show that the use of this questionnaire would provide general information on each participant, and therefore enable us to recommend specific types of exercise respectively. This would probably result in a lower tendency to give up exercising and would have a positive effect on the participants' will and attitude towards exercise

Keywords: Zumba fitness, PIEQ, Exercise motivation

UVOD

Zumba fitness je dinamičan program grupnog vježbanja koji spaja elemente aerobnog treninga sa plesnim koracima te je trenutno jedan od najpopularnijih fitness programa u svijetu (Thompson, 2011). Najviše je inspiriran latino-američkim, ali i internacionalnim ritmovima tvoreći zabavan i učinkovit program vježbanja. U takav fitness program ukomponirane su sve osnovne komponente tjelesnog vježbanja: kardiorespiratorna izdržljivost,

mišićna izdržljivost i snaga, ali i fleksibilnost. Koraci koji se lako prate i pokreti tijelom unaprijeđuju nivo ravnoteže i koordinacije (Sanders, Prouty, 2012), što trenutno čini zumbu atraktivnim oblikom vježbanja. Vježbači, u ovom slučaju vježbačice, imaju različite motive za početak sudjelovanja u nekom fitness programu. Prilikom prijavljivanja za program vježbanja, pojedince se najčešće ne propituju razlozi vježbanja već ih se uključuje u program po njihovim željama. Zašto netko pristupa pojedinom obliku vježbanja pokušali smo doznati putem PIEQ upitnika. *Personal Incentives for Exercise Questionnaire* (PIEQ), upitnik je osobnih poticaja za vježbanje, a služi kao instrument kojim se procjenjuju osobni ciljevi u vježbanju. Uz takav upitnik, vježbačice su odgovarale i na pitanja o načinu života, kako bi se dobila okvirna slika njihovih dnevnih aktivnosti i navika. Sve to napravljeno je s ciljem da se utvrdi povezanost sociodemografskih karakteristika sa motivima i razlozima za vježbanje zumba programa.

METODE RADA

Uzorak ispitanika činile su polaznice zumba programa (N=51), prosječne dobi 36.58 ± 12.81 godina koje su u program uključene u prosjeku 2 godine. Uzorak varijabli sastojao se od PIEQ upitnika (*Personal Incentives For Exercise Questionnaire*) i upitnika o općim informacijama životnih navika (Duda i sur. 1989). Ispitanice su upitnik ispunjavale jednom, početkom godišnjeg ciklusa vježbanja. Varijable su analizirane na način da je najprije napravljena faktorska analiza, zatim su deskriptivnom statistikom prikazane vrijednosti odgovora "aktivnosti na poslu" i PIEQ odgovora te analiza varijance. Na poslijetku je izračunata korelacija dobi ispitanica te staža vježbanja sa faktorskim varijablama.

REZULTATI

U tablici 1. Prikazani su rezultati faktorske analize PIEQ upitnika kojom su ekstrahirana četiri faktora (latentne dimenzije) po Guttman-keiserovom kriteriju, (varimax norm).. Na prvom faktoru vidljive su visoke projekcije varijabli PIEQ 5 i PIEQ 7. Drugi faktor karakteriziraju visoke projekcije varijabli PIEQ 8, PIEQ 12 i PIEQ 13. Treći faktor su obilježile visoke projekcije varijabli PIEQ 2 i PIEQ 4, dok je na četvrtom faktoru visoko projicirana samo jedna varijabla PIEQ 3. Prvu latentnu dimenziju moguće je imenovati kao „društveni faktor“. Drugi faktor je „faktor fizičke spremnosti“, dok treći faktor možemo nazvati „faktorom izgleda“. Četvrti faktor s projekcijom samo jedne varijable imenovan je „želja za natjecanjem“.

Tablica 1. Rezultati faktorske analize

	Factor1	Factor2	Factor3	Factor4
PIEQ 2	0.11	-0.5	0.89*	0.00
PIEQ 3	0.15	-0.13	-0.09	0.85*
PIEQ 4	-0.10	0.19	0.88*	-0.06
PIEQ 5	0.83*	0.06	0.04	-0.06
PIEQ 6	0.57	0.48	-0.05	0.42
PIEQ 7	0.88*	0.00	0.08	0.12
PIEQ 8	0.02	0.79*	-0.02	-0.37
PIEQ 9	0.57	0.40	-0.25	-0.27
PIEQ 10	0.39	0.21	-0.27	-0.50
PIEQ 11	0.60	-0.01	0.03	0.42
PIEQ 12	0.00	0.76*	0.07	-0.13
PIEQ 13	0.22	0.71*	0.43	0.07
PIEQ 14	0.16	0.61	0.00	0.17
Expl.Var	3.06	2.74	1.92	1.66
Prp.Totl	0.22	0.20	0.14	0.12

Legenda: Factor 1-4- Značajni faktori po Guttman-keiserovom kriteriju, PIEQ (2-14) pitanja Personal Inctives for Exercice Questionnaire, Expl.Var,-varijanca faktora, Prp.Totl-količina objašnjene varijance svih varijabli-

U tablici 2. Prikazane su aritmetičke sredine faktorskih varijabli i varijabli odgovora „aktivnosti na poslu“ te analiza varijance. Prikazane varijable PIEQ odgovora su samo one, koje su imale visoku projekciju na neki od faktora, a aritmetičke sredine (AS a, b, c) su odgovori na pitanja „aktivnosti na poslu“

Tablica 2. Deskriptivna statistika i analiza varijance

	AS a	AS b	AS c	ANOVA
PIEQ2	1.34	1	0.50	0.32
PIEQ3	-0.3	-0.66	-0.50	0.70
PIEQ4	0.76	0.73	1	0.96
PIEQ5	0.76	0.73	2	0.29
PIEQ7	0.69	0.20	2	0.05
PIEQ8	1.50	1.80	2	0.30
PIEQ12	1.65	1.80	2	0.49
PIEQ13	1.42	1.60	1.5	0.78

Legenda: PIEQ (2-13)-pitanja Personal Inctives for Exercice Questionnaire, AS (a-sjede,b-kreću se,c-fizički rade)-Aritmetička sredina odgovora na pitanja o aktivnosti na poslu-, ANOVA-analiza varijance

Korelaciju između predhodno navedenih faktorskih varijabli i dobi ispitanica prikazali smo u tablici 3. Uočljivo je kako ne postoji korelacija između navedenih varijabli.

Tablica 3. Tablica korelacija dobi i PIEQ pitanja

	GOD ROĐ
PIEQ 2	0.19
PIEQ 3	-0.01
PIEQ 4	-0.08
PIEQ 5	-0.09
PIEQ 7	0.02
PIEQ 8	-0.17
PIEQ 12	-0.14
PIEQ 13	0.12

Legenda: PIEQ (2-13) pitanja- Personal Inctives for Exercice Questionnaire, GOD ROĐ dob ispitanica

Pozitivna korelacija između staža vježbanja i PIEQ7 vidljiva je u tablici 4. S ostalim odgovorima na PIEQ pitanja, staž vježbanja nema korelaciju.

Tablica 4. Tablica korelacijaPIEQ pitanja i staža u vježbanju

	STAŽ VJEZBANJA
PIEQ 2	-0.08
PIEQ 3	-0.08
PIEQ 4	-0.02
PIEQ 5	0.18
PIEQ 7	0.29*
PIEQ 8	-0.11
PIEQ 12	0.02
PIEQ 13	-0.19

Legenda: PIEQ (2-13)- pitanja Personal Inctives for Exercice Questionnaire- STAŽ VJEZBANJA-ukupno vrijeme vježbanja tog fitness programa-

RASPRAVA

Rezultati ovog istraživanja ukazuju na nekoliko glavnih nalaza. Ponajprije, iz PIEQ upitnika, vidljivo je kako su „društveni faktor“ obilježili pozitivni odgovori na dva pitanja. Većina ispitanica odgovorila je da vježba zbog osjećaja zajed-

ništva te potrebe za socijalnim kontaktom i proširenjem poznanstava. Samim tim potvrđuje se činjenica kako je zumba atraktivan oblik grupnog vježbanja (B. Perez i M. Greenwood-Robinson, 2009) u kojem se, u ovom slučaju, samo vježbačice, ugodno osjećaju unutar grupe u kojoj zajedno vježbaju (plešu). Drugi faktor, „fizička spremnost“ definirali su pozitivni odgovori na tri pitanja. Tu su se vježbačice izjasnile da vježbaju zbog zdravlja, da budu u boljoj kondiciji te da poboljšaju svoju snagu. Takvi odgovori na pitanja opravdani su karakteristikama zumbe kao grupnog oblika vježbanja koji pridonose statistički značajnim učincima u poboljšanju funkcionalnih i motoričkih sposobnosti žena. (Mandarić, Sibinović, Mikalački, Stojiljković, 2011; Oreb, Matković, Vlašić, Kostić, 2007). Treći faktor, „faktor izgleda“ opisan je odobravanjem odgovora da vježbaju zbog poboljšanja vlastite pojavnosti (izgleda) te kako bi „dotjerale“ vlastitu tjelesnu težinu. Donges, Duffield, & Drinkwater (2010), dokazali su kako su kod zumbe, kao grupnog oblika aerobnog vježbanja, prisutne promjene u sastavu tijela žena. „Želja za natjecanjem“ projicirana je na četvrtom faktoru te jedina ima negativni predznak, odnosno neslaganje ispitanica s takvom izjavom. Iz rezultata je vidljivo da se kod PIEQ3 izdvaja negativni predznak. Tvrdnja koju ispitanice u tom pitanju ne odobravaju jest ta da „vježbaju zbog želje za natjecanjem“. Bez obzira na vrstu posla koju rade (a-sjede, b-kreću se, c-fizički rade), ispitanice nisu došle vježbati program zumbe kako bi se natjecale. Zumbu, kao plesni oblik vježbanja, ne karakterizira natjecateljski duh između vježbačica jer je cilj sata individualno savladati koreografiju a ne se natjecati sa drugima.

Daljnim pregledom rezultata uočava se kako nema značajne korelacije između dobi ispitanica i izdvojenih tvrdnji (PIEQ pitanja). Naime, bez obzira na dob, ispitanice imaju druge motive i razloge vježbanja te dob ne korelira sa onim pitanjima koja su imala najviše projekcije na faktore. Obzirom da je zumba program primjenjiv širokom spektru dobi vježbača i vježbačica, pokazalo se kako je zumba, u ovom slučaju, primjenjiva od 16-73 godine.

Međutim, vidljiva je pozitivna korelacija staža vježbanja zumba programa sa PIEQ7, tvrdnjom da ispitanice vježbaju zbog „potrebe za socijalnim kontaktom i proširenjem poznanstava“. Takva korelacija je očekivana (mod. prema Maehr 1986.), obzirom da vježbačice dolaze plesati/vježbati u sredinu koja im je ugodna, u kojoj će se družiti sa ljudima koji sudjeluju u istoj vrsti vježbanja ili će upoznati neke nove vježbače-plesače. Isto tako, vježbačice koje „plešu“ zumbu već neko vrijeme, ponovno se vraćaju u poznatu sredinu, znaju što očekivati od voditelja, poznaju druge vježbačice te im odgovara takva atmosfera pa ne mijenjaju program vježbanja.

ZAKLJUČAK

Primjenom ovakvog istaživanja dobili smo odgovore na pitanja tko, koliko i zašto vježba program zumbe. Koje su to socio-demografske karakteristike, u ovom sučaju vježbačica, koje su tek počele ili već nekoliko godina vježbaju isti plesni fitness program. Rezultati su djelomično očekivani, ako u obzir uzmemo sve karakteristike zumbe. Međutim, dokazali smo kako bi primjenom ovakvog upinika dobili «okvirnu sliku» pojedine vježbačice (vježbača) te joj, u skladu s tim, preporučili kakav oblik vježbanja bi joj najviše odgovarao. Takav potez bi vjerojatno rezultirao manjim odustajanjem od vježbanja nakon nekog vremena, a vježbačicama bi pozitivno djelovao na želju i stav o vježbanju.

LITERATURA

Donges, C.E., Duffield, R., Drinkwater, E.J. (2010). Effects of resistance or aerobic exercise training on interleukin-6, C-reactive protein, and body composition. *Medicine and science in sports and exercise*, 42(2), 304-413.

Duda, J. L., Tappe, M. K. (1989). The Personal Incentives For Exercise Questionnaire: preliminary development. *Perceptual and motor skills*, 68, 1122-1122

Maehr, M.L., Braskamp, L. A. (1986). *The motivation factor: A theory of personal investment*, England: Lexington Books/D. C. Heath and Com. pp 283

Mandarić, S., Sibinović, A., Mikalački, M., Stojiljković, S. (2011). The effects of the program HI-Low aerobics on morphological characteristics and functional ability students in the eight grade. *Journal of Sports science and Health*, 1(1), 18-23.

Oreb, G., Matković, B., Vlašić, J., Kostić, R. (2007). The structure of the functional abilities of the dancers. *Croatian sports herald*, 9(1), 16-23

Perez, B., Greenwood-Robinson, M.V. (2009). *Zumba: Ditch the workout, join the party! The Zumba weight loss program*. New York, NY: Maggie Greenwood-Robinson

Sanders, M. E., Prouty, J. (2012). Zumba Fitness is gold for all ages. *ACSM'S Health & Fitness Journal*, 16 (2), 25–28.

Thompson, W.R. (2011). Worldwide survey of fitness trends for 2012. *ACSM'S Health & Fitness Journal* 15 (6), 9-18

Razlike u parametrima ventilacijske funkcije pluća mladih odbojkašica prema kriteriju natjecateljske uspješnosti

Sanja Vitaić, Marko Erceg, Mirjana Milić

Kineziološki fakultet, Sveučilište u Splitu, Hrvatska

ABSTRACT

Spirometry is a very acceptable method of sport diagnostics; due to its simple application, it is used in measuring lung capacity and speed of air flow through the airways.

The aim of this research was to determine the sizes of lung function indicators in 56 young volleyball female players coming from county Splitsko-Dalmatia, whose average chronological age was 14,1 years, as well as the differences according to the criterion of competitive success.

The application of Student independent samples t-test indicated a significant difference in the defined subgroups of successful (n=32) and less successful (n=24) players, regarding the indicators of absolute value of maximum expiratory flow at 50% and maximum expiratory flow at 25%.

The obtained results indicate the importance of dynamic lung indicators in the differentiation of successful and less successful young female volleyball players.

Key words: spirometry, vital capacity, volleyball, t-test

UVOD

Kvalitetni radni kapacitet je preduvjet dobre sportske izvedbe a u sportskoj praksi se procjenjuje funkcionalnošću energetske sustava (Foretić i sur., 2013). Energetski sustavi u uskoj su vezi s primitkom kisika i izmjenom tvari, procesima koji započinju disanjem u plućima. Disanje kao kompleksan proces sastoji

se od ventilacije, kojom se ritmički i neprekidno obnavlja zrak u plućima, difuzije kisika i ugljičnog dioksida kroz alveolarnu membranu i odgovarajućeg protoka krvi u plućnim kapilarama (Guyton, 1985).

Ventilacijska funkcija pluća koja označava mehanizam udisanja i izdisanja, odnosno kretanja zraka između atmosfere i alveola u plućima ispituje se metodom *spirometrije* koja mjeri statičke volumene i kapacitete te dinamičke plućne volumene. Spirometrija je veoma prihvatljiva metoda za dijagnostikovanje u sportu zbog jednostavnog načina primjene. Dva testa koja se najčešće primjenjuju za definiranje ventilacijske funkcije pluća kod sportaša i opće populacije su *forsirani vitalni kapacitet* i *maksimalna voljna ventilacija*.

Plućna ventilacija predstavlja mjeru zdravstvenog statusa sportaša koji određuje mogućnost sportaša da kvalitetno, optimalno i uspješno trenira. Iako Willmore (1990) ukazuje da se generalno, plućni volumeni i kapaciteti neznajčajno mijenjaju pod utjecajem treninga, odnosno da se vitalni kapacitet blago povećava ali sveukupni plućni kapaciteti ostaju nepromijenjeni, ipak na razvoj funkcije disanja različito utječu različiti sportovi. Prakrash i sur. (2007) zapažaju djelotvorniju ventilaciju kod ljudi koji su sustavnim vježbanjem znatno bolje prilagođeni fizičkim naporima. Na povećanje vitalnog kapaciteta najveći utjecaj imaju aerobni, dok na povećanje brzine prolaska zraka najviše anaerobni podražaji (Jeličić, 2000).

Ispitivanje plućne funkcije spada u važne dijagnostičke postupke u sportu. Manja prisutnost ove tematike može se donekle objasniti uvriježenim mišljenjem da analiza ventilacije u sportu nije toliko bitna obrazlažući to postojanjem velikih kapaciteta u sportaša te njenim malim utjecajem na potrošnju kisika (Jeličić, 2000).

Drugim riječima smatralo se da su sportaši ventilacijski spremni za vršenje bilo kojeg rada. Istraživanja ove vrste provedena su na veslačima, jedriličarima, plivačima, vaterpolistima te dijelom na košarkašima, nogometašima, rukometašima i odbojkašima u laboratorijskim uvjetima i na terenu.

Mehrotra i sur. (1998) ustanovili su, uspoređujući rezultate forsiranoga vitalnog kapaciteta, forsiranoga ekspiratornog volumena i maksimalnoga ekspiracijskog protoka između nogometaša, hokejaša, odbojkaša, plivača, košarkaša i kontrolne skupine ispitanika, da rezultati u navedenim parametrima pokazuju značajne razlike u korist svih skupina sportaša, a najbolje rezultate ventilacijske funkcije pluća postigli su plivači.

Ventilacijske vrijednosti u dječjoj dobi i u pubertetu mijenjaju se usporedno s promjenama antropometrijskih karakteristika. U tom razdoblju vježbom i treninzima može se utjecati na razvoj ventilacijskih vrijednosti pluća (Cuurteix i sur., 1997; Lakhera, 1994; Marinović i Tocigl, 1999; Tocigl i sur., 1999).

Hraste i sur. (2008) u svom istraživanju utvrdili su značajne učinke povećanja ventilacijske vrijednosti funkcije pluća mladih sportaša vaterpolista s tri, pet i sedam godina sportskoga trenažnog staža koji su uzrokovani programiranim treningom i vremenom provedenim u njemu.

Međutim, mali je broj istraživanja u dobi rasta i razvoja vezanih uz kardiovaskularni i respiratorni sustav odbojkaša(ica).

U skladu s navedenim, cilj ovog istraživanja je utvrditi veličine parametara ventilacijske funkcije mladih odbojkašica te njihove razlike prema kriteriju natjecateljske uspješnosti

METODE RADA

Uzorak ispitanika predstavlja 56 odbojkašica Splitsko-dalmatinske županije, mlađe kadetske dobne skupine. Prosječna kronološka dob ispitanica je 14,09 godina, prosječna tjelesna visina $168,66 \pm 6,68$, prosječna tjelesna masa $58,34 \pm 9,07$ te prosječni Indeks tjelesne mase (ITM) $20,48 \pm 2,80$. Sve ispitanice bili su sudionice Državnog prvenstva u odbojci za mlađe kadetkinje u Rovinju, 2015.

Natjecateljska uspješnost igračica određena je na Likertovoj ljestvici od 1 do 5. Svakoj igračici dodijeljena je ocjena od 1 do 5 s obzirom na dva kriterija: *Plasman ekipe na natjecanju* i *Kvaliteta igračice unutar ekipe (prema procjeni trenera)*. Sve igračice kojima su dodijeljene ocjene od 1 do 3 predstavljale su skupinu manje uspješnih, a sve igračice kojima su dodijeljene ocjene 4 i 5 predstavljale su skupinu uspješnijih prema Grgantov (2005) i Milić (2014).

Temeljem navedenog, uzorak ispitanika je podijeljen na dvije skupine prema kriteriju natjecateljske uspješnosti na uspješne ($n=32$) i manje uspješne ($n=24$) mlade odbojkašice

Sve ispitanice imale su natjecateljsku iskaznicu Hrvatske odbojkaše udruge ovjerenu od strane nadležnog sportskog liječnika.

Skup testova prediktorskih varijabli sastoji od šest ventilacijskih pokazatelja i dvije morfološke mjere. Spirometrijskim postupkom izmjereni su statički i dinamički volumeni, kao i krivulja protok-volumen. Od statičkih kapaciteta izmjeren je *forsirani vitalni kapacitet* (FVC), a od dinamičkih *forsirani ekspiracijski volumen u prvoj sekundi* (FEV1) i *Tiffeneau index* (FEV1/%FVC). Krivuljom protok-volumen izmjereni su *forsirani ekspiracijski protoci pri 50%FVC* (MEF50) i *25%FVC* (MEF25). *Maksimalna voljna ventilacija* (MVV) je metoda koja ukazuje na stanje respiratornih mišića, popustljivost pluća i otpor dišnih puteva. Mjerenja su izvršena aparatom microQuark PC-based spirometer (Cosmed, Italy) uz pisani pristanak i dozvolu roditelja. Ispitanice su ponavljale tri puta forsirani ekspirij u sjedećem položaju, a procedure mjerenja odrađene su prema poznatim standardima (Knudson i sur., 1976., te Miller i sur., 2005).

Morfološke mjere koje su korištene u ovom istraživanju su: *tjelesna visina* i *tjelesna masa*, uz kojih je naknadno izračunat *indeks tjelesne mase* izražen omjerom tjelesne mase u kilogramima i kvadratom tjelesne visine u metrima.

U skladu s ciljem ovog istraživanja obrada podataka je izvršena na način da su izračunati osnovni deskriptivni pokazatelji apsolutnih vrijednosti parametara ventilacijske funkcije pluća, dviju morfoloških mjera i indeksa tjelesne mase: aritmetička sredina (AS), standardna devijacija (SD), minimalni rezultat (MIN), maksimalni rezultat (MAX), mjere asimetričnosti distribucije (SKEW), mjere zakrivljenosti distribucije (KURT) te vrijednost za utvrđivanje statistički značajnog odstupanja izmjerenih varijabli od normalne distribucije (MaxD) primjenom Kolmogorov- Smirnovljevog testa (KS-test).

Za utvrđivanje razlika ventilacijskih pokazatelja između podskupina definiranih prema kriterijskoj varijabli natjecateljske uspješnosti mladih odbojkašica primijenio se Studentov, t-test za nezavisne uzorke pri čemu su izračunati vrijednosti koeficijenta t-testa te nivo značajnosti p. Sva obrada izvršena je računalnim paketom *Statistica*, ver.12.00.

REZULTATI

U tablici 1 prikazani su rezultati deskriptivne statistike morfoloških varijabli, apsolutnih vrijednosti parametara ventilacijske funkcije pluća odbojkašica mlađe kadetske dobne skupine (N=57).

Tablica 1. Deskriptivna statistika morfoloških značajki te apsolutnih vrijednosti parametara ventilacijske funkcije pluća mladih odbojkašica mlađe kadetske dobi (N=57)

Varijable	AS	M	Min	KS	SD	MaxD	Skew	Kurt
Tjelesna visina (cm)	168,66	169,50	150,00	180,00	6,68	0,10	-0,68	0,31
Tjelesna masa (kg)	58,34	58,00	38,00	78,00	9,07	0,07	0,08	-0,42
Indeks tjelesne mase (kg/m ²)	20,48	20,15	15,40	27,00	2,80	0,08	0,50	-0,31
APSOLUTNE VRIJEDNOSTI								
Forsirani vitalni kapacitet-FVC (l)	3,14	3,07	2,07	4,36	0,49	0,10	0,46	-0,13
Forsirani ekspiracijski volumen u prvoj sekundi / forsirani vitalni kapacitet -FEV1 (l)	2,99	2,91	1,99	4,23	0,51	0,12	0,66	0,29
Forsirani ekspiracijski volumen u prvoj sekundi / forsirani vitalni kapacitet -FEV1/FVC (l)	94,53	95,90	83,80	99,60	3,80	0,15	-0,84	0,15
Maksimalni ekspiracijski protok pri 50% FVC- MEF ₅₀ (l)	4,25	4,08	2,89	6,20	0,81	0,13	0,32	-0,86
Maksimalni ekspiracijski protok pri 25% FVC- MEF ₂₅ (l)	2,61	2,50	1,40	4,10	0,73	0,11	0,47	-0,61
Maksimalna voljna ventilacija-MVV	109,58	108,05	59,60	152,40	20,52	0,05	0,13	-0,13

KS= 0,20

LEGENDA: AS – aritmetička sredina, M – medijan, Min – minimalna vrijednost, Max – maksimalna vrijednost, SD – standardna devijacija, MaxD – vrijednost za utvrđivanje statistički značajnog odstupanja izmjerenih varijabli od normalne distribucije, Skew – koeficijent asimetrije distribucije, Kurt – koeficijent zakrivljenosti distribucije, KS – Kolmogorov-Smirnovljevi test.

Uvidom u tablicu 1 vidljivi su rezultati deskriptivne statistike morfoloških varijabli i *indeksa tjelesne mase* te *apsolutnih vrijednosti* parametara ventilacijske funkcije pluća mladih odbojkašica mlađe kadetske dobi (N=57).

Analiza distribucijskih parametara pokazuje da sve korištene varijable značajno ne odstupaju od normalnih vrijednosti raspršenosti te da su pogodne za daljnju multivarijatnu statističku obradu. Testiranje normaliteta dis-

tribucije izvršeno je Kolmogorov-Smirnovljevim testom čija kritična vrijednost iznosi 0,20.

Usporedbom prosječnih rezultata vrijednosti parametara ventilacijske funkcije pluća kod mladih odbojkašica prikazanih u tablici 1 s referentnim vrijednostima plućne ventilacije, dobivene su povećane vrijednosti u parametrima: *forsirani ekspiracijski volumen u prvoj sekundi/forsirani vitalni kapacitet -FEV1/FVC, maksimalni ekspiracijski protok pri 50% FVC- MEF₅₀ te maksimalni ekspiracijski protok pri 25% FVC- MEF₂₅* zatim prosječne referentne vrijednosti kod parametra *forsirani ekspiracijski volumen u prvoj sekundi-FEV1*, dok su ostala dva parametra nešto niža *forsirani vitalni kapacitet-FVC i maksimalna voljna ventilacija-MVV*.

U tablici 2 prikazane su aritmetičke sredine morfoloških značajki i parametara ventilacijske funkcije pluća uspješnijih (n=32) i manje uspješnih (n=24) te njihove razlike korištenjem Studentovog, t-testa za nezavisne uzorke

Tablica 2. Deskriptivni pokazatelji i analiza razlike morfoloških značajki i parametara ventilacijske funkcije pluća uspješnijih i manje uspješnih mladih odbojkašica

Varijable	Manje uspješne (N=24)	Uspješnije (N=32)	t test	p	
	AS	AS			
Tjelesna visina (cm)	167,42	169,59	-1,21	0,23	
Tjelesna masa (kg)	57,83	58,72	-0,36	0,72	
Indeks tjelesne mase (kg/m ²)	20,54	20,43	0,14	0,89	
APSOLUTNE VRIJEDNOSTI	Forsirani vitalni kapacitet-FVC (l)	3,06	3,20	-1,01	0,32
	Forsirani ekspiracijski volumen u prvoj sekundi-FEV1 (l)	2,89	3,08	-1,23	0,23
	Forsirani ekspiracijski volumen u prvoj sekundi / forsirani vitalni kapacitet -FEV1/FVC (l)	93,58	95,43	-1,59	0,12
	Maksimalni ekspiracijski protok pri 50% FVC- MEF ₅₀ (l)	3,95	4,47	-2,47	0,02
	Maksimalni ekspiracijski protok pri 25% FVC- MEF ₂₅ (l)	2,29	2,85	-3,02	0,00
	Maksimalna voljna ventilacija-MVV	107,55	111,10	-0,64	0,53

LEGENDA: AS – aritmetička sredina, t-test – vrijednost koeficijent statističke značajnosti, p – nivo statističke značajnosti.

Analizom rezultata u tablici 2 vidljivo je kako uspješnije mlađe kadetkinje imaju veće prosječne vrijednosti u morfološkim značajkama *tjelesna visina* i *tjelesna masa*, manju vrijednost *indeksa tjelesne mase* te veće prosječne apsolutne vrijednosti svih mjerenih ventilacijskih parametara. Studentovim, t-testom za nezavisne uzorke utvrđena je značajna razlika između dvije podskupine mladih odbojkašica prema kriteriju natjecateljske uspješnosti u dva od ukupno šest spirometrijskih testova: *maksimalni ekspiracijski protok pri 50% FVC- MEF_{50}* i *maksimalni ekspiracijski protok pri 25% FVC- MEF_{25}* .

DISKUSIJA I ZAKLJUČAK

Primjenom Studentovog, t-test za nezavisne uzorke, izvršena je analiza razlika ventilacijskih parametara između podskupina definiranih prema kriterijskoj varijabli natjecateljske uspješnosti mladih odbojkašica pri čemu je utvrđena značajna razlika u dva testa ventilacijske funkcije pluća od ukupno primijenjenih 6 parametara. Uspješne odbojkašice su u svim testovima imale veće apsolutne prosječne vrijednosti spirometrijskih testova u odnosu na manje uspješne.

U parametrima ventilacijske funkcije pluća *maksimalni ekspiracijski protok pri 50% FVC- MEF_{50}* i *maksimalni ekspiracijski protok pri 25% FVC- MEF_{25}* uspješnije mlade odbojkašice značajno se razlikuju od manje uspješnih odbojkašica. Parametri *MEF_{50}* i *MEF_{25}* sastavni su dio krivulje protok-volumen te ih možemo promatrati kao dinamičke plućne parametre jer su vezani uz faktor-vrijeme i određuju prohodnost dišnih puteva. Parcijalno gledajući, navedeni parametri, pripadaju zadnjem (trećem) dijelu ekspiracijskog dijela krivulje protok-volumen te su isključivo ovisni o elastičnoj sili pluća. Možemo pretpostaviti kako je struktura treninga kod uspješnijih odbojkašica više utjecala na elastičnu silu pluća i prohodnost dišnih puteva, što objašnjava dobivene rezultate.

Bilo je za očekivati kako će upravo uspješnije mlađe kadetkinje, koje su nešto više i teže, a samim time imaju i „veća“ pluća, postići bolje rezultate spirometrijskih parametara. Poznato je kako vježbe dominantno aerobnog karaktera pozitivno utječu na vitalni kapacitet, a vježbe anaerobnog karaktera doprinose razvoju dinamičkih parametara ventilacije. Odbojku karakteriziraju prvenstveno opterećenja anaerobnog alaktatnog karaktera. Kratki poeni prosječnog trajanja od 7 sekundi, odvojeni su pauzama prosječnog trajanja od 14 sekundi. Akcije tijekom poena obiluju skokovima, ubrzanjima, brzim promjenama pravca kretanja i prizemljenjima. Zbog toga su uspješnije odbojkašice često brže i eksplozivnije od manje uspješnih, a odlikuje ih i dobra skočna

izdržljivost (Lidor i Ziv, 2010; Borrás i sur., 2011; Milić i sur., 2012; Grgantov i sur., 2013). Može se pretpostaviti da je takva struktura motoričkih i funkcionalnih sposobnosti kod uspješnijih odbojkašica dijelom uzrokovala i njihove značajno bolje rezultate u dinamičkim ventilacijskim pokazateljima u usporedbi s manje uspješnim suigračicama.

Naime, plućna funkcija znatno se mijenja s dobi. Minutna ventilacija raste s dobi do fizičke zrelosti, a onda se smanjuje s povećanjem dobi. Te su promjene povezane s rastom cjelokupnog plućnog sustava. Od vremena kada dijete ulazi u vrtić sve do puberteta, težina pluća povećava se gotovo trostruko, od prosječno 211 g do 640 g. Tijekom tog vremena vitalni kapacitet - VC raste od otprilike 1000 mL do 3000 mL, kao i totalni plućni kapacitet od 1400 mL do 4500 mL. Plućna struktura nije u potpunosti razvijena u trenutku rođenja, a broj alveola i dišnih puteva povećava se gotovo 10 puta prije nego što dijete dosegne zrelost. U kasnom djetinjstvu i adolescenciji, navedene promjene javljaju se uglavnom kroz proširenje postojećih alveola i dišnih puteva. Ipak, utjecaj treninga na dišni sustav neobično je značajan. Vježbe koje zahtijevaju veliki minutni volumen disanja potiču rast i razvoj prsnog koša kod mladih odbojkašica te na taj način grudni koš postaje širi, dulji i ima veću zapreminu. U većem prsnom košu razvijaju se tzv. „sportska pluća“ s većim obujmom zraka, ali i krvi te povećanom površinom plućnih alveola. Nadalje, trening jača i dovodi do hipertrofije dišne muskulature, kao i do ekonomičnijeg disanja s manjom frekvencijom (Lakhera i sur., 1994; Jeličić, 2000; Hraste, 2004).

Značaj ovog istraživanja je da posluži stručnim timovima u selekcijske svrhe pri planiranju i programiranju trenažnog procesa natjecateljica mlađih dobnih skupina u odbojci.

LITERATURA

Borrás, X., Balius, X., Drobnic, F., & Galilea, P. (2011). Vertical jump assessment on volleyball: A follow-up of three seasons of a high-level volleyball team. *Journal of Strength and Conditioning Research*, 25(6), 1686-1694.

Courteix, D., Obert, P., Lecoq, A.M., Guenon, P., & Koch, G. (1997). Effect of intensive swimming training on lung volumes, airway resistance and on the maximal expiratory flow-volume relationship in prepubertal girls. *European Journal of Applied Physiology*, 76(3), 264-9.

Foretić, N., Uljević O., Rogulj, N., & Marinović, M. (2013). Plućna funkcija rukometaša različitih dobnih kategorija. *Hrvatski športskomedicinski Vjesnik* 28(1), 47-51.

Grgantov, Z. (2005). *Identifikacija morfoloških i motoričkih sklopova odbojkašica u odnosu prema uzrastu i situacijskoj učinkovitosti*. Doktorska disertacija. Zagreb: Kineziološki fakultet Sveučilišta u Zagrebu.

Grgantov, Z., Milić, M., & Katić, R. (2013). Identification Of Explosive Power Factors As Predictors Of Player Quality In Young Female Volleyball Players. *Collegium Antropologicum*, 37(Suppl.2), 61-68.

Guyton, C.A.(1985). *Medicinska fiziologija*. Beograd – Zagreb: Medicinska knjiga.

Hraste, M. (2004). Ventilacijske funkcije pluća kod mladih vaterpolista. Magistarski rad. Zagreb: Kineziološki fakultet Sveučilišta u Zagrebu.

Hraste, M., Lozovina, V., & Lozovina, M. (2008). Utjecaj višegodišnjeg treninga na statičke i dinamičke plućne volumene i kapacitete mladih vaterpolista. *Naše more: znanstveni časopis za more i pomorstvo*, 55(3-4), 153-159.

Jeličić, M. (2000.). Ventilacijske funkcije pluća kod mladih jedriličara i košarkaša. Magistarski rad. Zagreb: Kineziološki fakultet Sveučilišta u Zagrebu.

Knudson, R.J., Slatin, R.C., Lebowitz, M.D., et al. (1976). The maximal expiratory flow-volume curve. Normal standards, variability, and effects of age. *American Review of Respiratory Disease*, 113(5), 587-600.

Lakhera, S.C., Kain, T.C., & Bandopadhyay, P. (1994). Changes in lung function during adolescence in athletes and non-athletes. *Journal of Sports Medicine and Physical Fitness*, 3(3), 258-262.

Lidor, R & Ziv, G. (2010). Physical and physiological attributes of female volleyball players - a review. *Journal of Strength and Conditioning Research*, 24(7), 1963-1973.

Marinović, M., & Tocilj, J. (1999). Respiracijske funkcije polaznika škole veslanja. U: D. Milanović (Ur.), *Zbornik radova „Kineziologija za 21. Stoljeće“*, (str. 379-381). Zagreb: Kineziološki fakultet Sveučilišta u Zagrebu.

Mehrotra, P.K., Varma, N., Tiwari, S., & Kumar, P. (1998). Pulmonary functions in Indian sportsmen playing different sports. *Indian Journal of Physiology and Pharmacology*, 42(3), 412-416.

Milić, M. (2014). Međupozicijske i unutarpozicijske razlike mladih odbojkašica u nekim antropoloških obilježjima. Doktorska disertacija. Split: Kineziološki fakultet Sveučilišta u Splitu.

Milić, M., Grgantov, Z., & Katić, R. (2013). Impact of Biomotor Dimensions on Player Quality in Young Female Volleyball Players. *Collegium Antropologicum*, 37(1), 93-99.

Miller, M.R., Hankinson, J., Brusasco, V, et al. (2005). Standardisation of spirometry. *European Respiratory Journal*, 26(2),319-338.

Prakash, S., Meshram, S., & Ramtekkar, U. (2007) Athletes, yogis and individuals with sedentary lifestyles; do their lung functions differ? *Indian Journal of Physiology and Pharmacology*, 51(1), 76-80.

Tociĝl, I., Baltagi, Z., & Jelićić, M. (1999), Razlike krivulje protok – volumen” u plućnoj ventilaciji kod mladih sportaša i nesportaša. U: D. Milanović (Ur.), *Zbornik radova „Kineziologija za 21. Stoljeće”*, (str. 383-385). Zagreb: Kineziološki fakultet Sveučilišta u Zagrebu.

Wilmore, J., & Costill, D. (1999). *Physiology of sport and exercise – second edition*. Human Kinetics.

Utjecaj intraabdominalnog pritiska (IAP) na izvođenje testa fleksije u zglobu kuka u sjedećem položaju

Biljana Kuzmanić, Ensar Abazović, Jelena Paušić

Kineziološki fakultet Sveučilišta u Splitu

ABSTRACT

Good spine stability is particularly important when it is strained during physical activity. Without a proper spine stabilization, muscle contraction of the extremities transfers forces proximally and causes spinal movements which put increased stress on the structure of the spine and the surrounding connective tissue, so there is a better chance for an injury of the protective structures of the spine. An increased intra-abdominal pressure (IAP) in the enclosed abdominal cavity contributes to improving the stability of the spine. The aim of this study was to assess the postural stability and to analyze the differences in stability of the spine by running the flexion test on a hip joint in sitting position among the examinees who consciously know how to increase the IAP by abdominal breathing and those who do not. The study was conducted on a sample of 24 examinees aged 20 to 22. The assessment of their knowledge on how to increase the IAP by abdominal breathing was conducted by three trained judges. Twelve variables of postural stability were estimated by the tensiometric platform Footscan (RsScan, Inc., UK) running the flexion test on a hip joint in sitting position. Three variables were singled out as significant in distinguishing the groups, namely the variables of the test which involved lifting the left leg, DIFF L%L, DIFF L%D and DIFF LCOFTTW. The results show that with the IAP, the way that the projected point of the centre of gravity of the body passes within the surface of the support, decreases when examinees lift their left leg.

Key words: postural stability, *diaphragm test*

UVOD

Jedan od pokazatelja našeg zdravlja je sposobnost samostalnog kretanja, a da bi se tjelesnim vježbanjem održala ili poboljšala funkcionalnost tijela i prevenirao nastanak disfunkcija potrebna je primjena kvalitetnih pokreta. Na koje će načine određene vježbe imati utjecaj na ljudsko tijelo ovisi o načinu izvođenja pokreta. Sportaše i nesportaše treba educirati da vježbaju s adekvatnim opterećenjima, također ih treba educirati kako mogu postići kvalitetnu stabilnost trupa i pokretljivost zglobova, dobro posturalno držanje i pravilne obrasce disanja.

Prema Kolář (2007.) integrirani sustav stabilizacije kralježnice (ISSS) sastoji se od uravnotežene aktivacije dubokih vratnih fleksora i leđnih ekstenzora vratne i gornje grudne regije, kao i dijafragme, mišića zdjeličnog dna, svih dijelova trbušnih mišića i ekstenzora kralježnice u donjoj grudnoj i lumbalnoj regiji. Dijafragma, mišići zdjeličnog dna i *m. transversus abdominis* reguliraju IAP i pružaju prednju lumbalno-zdjeličnu posturalnu stabilnost (McGill, 1990.). Ovi intrinzični leđni mišići stabilizatori osiguravaju stabilnost kralježnice u koordinaciji s IAP-om, koja služi za pružanje dinamičke stabilnosti (Frank i sur., 2013.)

Trbušna **šupljina** je prostor ograničen dijafragmom poviše i međicom (perineum) ispod, lumbalno-krstačnom kralježnicom posteriorno i zidovima trbušne **šupljine** anterolateralno. Intra-abdominalni pritisak (IAP) je stalni pritisak unutar trbušne **šupljine** i brzo se povećava tijekom mišićne aktivnosti i naprezanja (Sugrue, 1995.). Prema De Keulenaer i sur. (2009.) prihvaćena standardna metoda mjerenja IAP-a je preko mjehura u ležećem položaju. Trbuh se ponaša kao hidraulički sustav s normalnim IAP-om od oko 5-7 mmHg, a s višim početnim razinama u pretilih pacijenata od oko 9-14 mmHg. Ovaj način predstavlja invanzivnu dijagnostičku metodu koja daje vrijednosti intraabdominalnog pritiska. Postavlja se pitanje je li standardna metoda mjerenja IAP-a i danas optimalna metoda u istraživanjima u kineziologiji gdje ispitanik treba dati pristanak za sudjelovanje u istraživanju s određenim indikacijama i mogućim komplikacijama. Kao alternativno rješenje u ovom istraživanju primjenjuje se neinvanzivna dijagnostička metoda dijafragma testom kojim se na jednostavan način može ocijeniti je li ispitanik uspijeva podići IAP. Dijafragma test je jedan od dijagnostičkih postupaka kliničke procjene usmjerene na funkciju sustava za kretanje i koristi se za ispitivanje posturalne stabilnosti (Kolář, 2013.). Regulacija IAP-a i integriranog sustava stabilizacije kralježnice (ISSS) može biti poremećena nedovoljnom posturalnom funkcijom dijafragme, što često rezultira povećanim kompresivim silama na kralježnicu zbog kompen-

zacijskih aktivnosti površinskih ekstenzora kralježnice i nepravilnim položajem grudi ili grudnog koša zbog neravnoteže između gornje i donje grudne muskulature (Kolář i sur., 2012.).

Za pravilnu posturu i kvalitetnu ravnotežnu stabilnost u stajanju i kretanju važnu ulogu imaju mišići trupa koji moraju proizvoditi mišićnu silu i kontinuirano održavati funkcionalnost pokreta. Stabilnost trupa zauzima važnu ulogu u sportu, kineziterapiji i svakodnevnom životu.

Mehanička stabilnost lumbalne kralježnice mora se održavati u svakom trenutku kako bi se spriječilo izvijanje i naknadne ozljede kada je kralježnica opterećena tijekom fizičke aktivnosti (Cholewicki i sur. 1999.). Prema Kisner i Colby, (2007.) bez adekvatne stabilizacije kralježnice, kontrakcija mišića ekstremiteta prenosi sile proksimalno i uzrokuje pokrete kralježnice koji postavljaju povećani stres na strukturu kralježnice i okolno vezivno tkivo. Lokalni zamor mišića prilikom stabilizacije segmenata kralježnice može se primijetiti kod repetitivnih aktivnosti i velikih napora. Tada postoji veća šansa za ozljedu osiguravajućih struktura kralježnice. Prema istim autorima dijafragma i mišići dna zdjelice se sinkronizirano kontrahiraju s *m. transversus abdominis*. Ovaj mehanizam ima nekoliko efekata u poboljšanju stabilnosti kralježnice: povećan IAP u zatvorenom prostoru abdomena, te rasterećuje kompresivne sile koje djeluju na kralježnicu. Također povećava stabilizacijski efekt guranjem van abdominalni prostor suprotstavljajući se kontrakciji abdominalnih mišića, time se provocira ekscentrična kontrakcija abdominalnih mišića, povećanjem duljine trajanja napetosti između njih i torakolumbalne facije (Kisner i Colby, 2007.).

Hodges i sur. (2005.), utvrđuju je li spinalna stabilnost povećana kada se povećava IAP bez istodobne aktivnosti trbušnih mišića i leđnih ekstenzora. Neprekidno povećanje IAP je izazvano električnom stimulacijom dijafragme putem stimulacije *n. phrenicus* jednog ili oba, na 20 Hz (5 sekundi) elektrodama koje su postavljene na vratnom dijelu u tri ispitanika. Spinalna stabilnost se mjerila kao sila potrebna da se premjesti sonda koja je postavljena na području spinosus processusa L4 i L2 u proniranom ležećem položaju. Električna stimulacija dijafragme povećala je IAP za 27-61% od maksimalnog voljnog povećanja tlaka i povećala je stabilnost kralježnice za 8-31% od vrijednosti u mirovanju. Povećanje stabilnosti kralježnice u pozitivnoj je korelaciji s povećanjem IAP-a. Rezultati ovog istraživanja daju dokaze da se stabilnost lumbalne kralježnice povećava s povećanjem IAP-a.

Primjenom testa fleksije u zglobu kuka u sjedećem položaju procjenjuje se posturalna stabilnost. Vrijednosti prijeđenog puta točke projekcije centra

težišta tijela unutar površine oslonca na Footscanu pokazatelj su posturalne stabilnosti (Milardović i sur., 2014.). Pokreti distalnim dijelovima tijela, lijevom i desnom nogom, utjecat će na sposobnost trupa da održi ravnotežu pokušavajući kompenzirati posturalnu nestabilnost koordiniranom mišićnom aktivacijom kako bi se postigla dobra izvedba testa.

Ovaj test koristi se u kliničke svrhe i ocjenjuje se subjektivnom metodom. Prema Kolář (2013.) palpacijom u preponskoj regiji procjenjuje se pritisak i zakrivljenost trbušne šupljine u toj regiji, a time aktivnost trbušnih mišića i ekstenzora kralježnice za vrijeme stabilizacije, te pokreti zdjelice.

Cilj ovog istraživanja je analizirati razlike u stabilnosti kralježnice izvođenjem testa fleksije u zglobu kuka u sjedećem položaju, između onih ispitanika koji znaju svjesno podići IAP abdominalnim disanjem i onih koji to ne znaju.

METODE RADA

Istraživanje je provedeno na uzorku od 24 ispitanika u dobi od 20 do 22 godine koji su pristali na sudjelovanje u istraživanju. Ispitanici su početnici u abdominalnom disanju, te su nakon provjere vještine svjesnog podizanja IAP-a od strane tri ocjenjivača podijeljeni u dvije grupe ovisno o tome jesu li sposobni svjesno podići IAP ili nisu. U grupi koja nije sposobna svjesno podići IAP je 13 ispitanika, a u grupi koja je sposobna svjesno podići IAP je 11 ispitanika.

Dvanaest varijabli procijenjeno je tenziometrijskom platformom Footscan (RsScan, Inc., UK):

T1L%L, T1L%D, T1L%COFTTW, T1D%L, T1D%D, T1D%COFTTW, TIAPL%L, TIAPL%D, TIAPL%COFTTW, TIAPD%L, TIAPD%D, TIAPD%COFTTW.

Dijafragma test (Kolář, 2013.) primijenjen je u svrhu grupiranja ispitanika u grupu koji su imali sposobnost podizanja IAP-a i grupu koja nije imala takvu sposobnost. Procjenu su izvršila tri educirana ocjenjivača koji imaju certifikat edukacije Dynamic Neuromuscular Stabilization prema Kolář (DNS).

Dijafragma test izvodi se u sjedećem položaju, ocjenjivač palpira prstima ispitanika bočno ispod donjih rebara, lagano vršeći pritisak protiv lateralne skupine trbušnih mišića, provjerava se položaj i kretanje donjih rebara, izvodi se procjena kvalitete i simetrije aktivacije. Ispravna aktivacija je simetrična aktivacija protiv prstiju ocjenjivača, donji grudni dio se širi u lateralnom smjeru, interkostalni prostor se širi, položaj rebara u transverzalnoj ravnini ostaje isti (rebra ne smiju biti podignuta), dobra stabilizacija lumbalne kralježnice i položaj grudne kralježnice bez fleksije.

Eksperimentalni postupak provodio se na tenziometrijskoj platformi Footscan (RsScan, Inc., UK). Sastojao se iz inicijalnog i finalnog mjerenja na Footscanu, ali i iz provjere znanja podizanja IAP-a svjesno, abdominalnim disanjem. Ispitanik je sjedio na rubu stola na Footscanu. Ispitanik se nije oslanjao na svoje ruke koje su bile opušteno. Najprije se izvodio test fleksije u zglobu kuka u sjedećem položaju s lijevom i desnom nogom po tri puta s nesvjesnim IAP-om, a zatim se izvodio isti test s lijevom i desnom nogom po tri puta nakon provjere znanja podizanja IAP-a svjesno.

Mjerenje je vršeno 10s za svaku varijablu, a podaci komponenti posturalne stabilnosti su uzeti na početku 5. sekunde dok se ispitanik stabilizirao na Footscanu, a ujedno nije došlo do zamora. Postupak provjere vještine svjesnog podizanja IAP-a proveo se s ciljem da ocjenjivači procjene koji ispitanik ne zna svjesno podići IAP. Ispitaniku je bilo objašnjeno na koji način abdominalno disati i povećati intraabdominalni pritisak. Prilikom udaha dijafragma se spušta i vrši se ekscentrična kontrakcija abdominalnih mišića, širi se zdjeljučna šupljina povećanjem tlaka unutar abdomena, nakon čega se izvodi test fleksije u zglobu kuka u sjedećem položaju.

Za analizu je upotrijebljen statistički program Statistica 12 (StatSoft, Inc., Tulsa, USA). Za potrebe ovog rada izračunati su za sve varijable osnovni deskriptivni parametri aritmetička sredina (AS) i standardna devijacija (SD). Testiranje normaliteta distribucije podataka izvršeno je primjenom Kolmogorov-Smirnovljeva testa (KS-test). U sklopu testiranja izračunato je maksimalno odstupanje između empirijske i teoretske relativne kumulativne frekvencije (max d) i p razina značajnosti. Za utvrđivanje pouzdanosti izračunat je koeficijent intraclass korelacije (ICC). Izračunati su deskriptivni pokazatelji varijabli razlika parametara u testu fleksije u zglobu kuka u sjedećem položaju lijeve i desne noge, ukupnih rezultata i po grupama. Za utvrđivanje razlika među grupama po diskriminacijskoj funkciji i koliko pojedine varijable pridonose toj razlici primjenjena je diskriminativna kanonička stupnjevita (forward) analiza.

REZULTATI I RASPRAVA

U tablici 1 prikazane su vrijednosti koeficijena intraklasne korelacije (ICC), prema kojem je utvrđena dobra pouzdanost između svih parametara. Parametri pomaka centra pritiska u sjedećem položaju smatrani su dovoljno pouzdani kada je koeficijent intraklasne korelacije $ICC > 0.4$ (van Dieën i sur. 2010.).

Također su u tablici 1 prikazane za sve varijable osnovni deskriptivni parametri aritmetička sredina (AS) i standardna devijacija (SD) ukupnog rezultata po česticama. Prosječni rezultati pokazuju da su se vrijednosti na jednoj strani smanjivale, a na drugoj povećavale kako bi se izjednačio pritisak. Ukoliko je podizana lijeva noga pritisak je bio jači na lijevoj strani i obrnuto. Prosječne vrijednosti prijeđenog puta točke projekcije centra težišta tijela unutar površine oslonca izraženog u milimetrima se smanjuju u testu s IAP-om pri podizanju lijeve noge, međutim pri podizanju desne noge prijeđeni put se povećava u testu s IAP-om. Možemo pretpostaviti da je to zbog toga jer su ispitanici dešnjaci i ide se s pretpostavkom da je lijeva noga odrazna i da su u svakodnevnom životu navikli na takve obrasce kretanja.

Testiranje normaliteta distribucije podataka izvršeno je primjenom Kolmogorov-Smirnovljevim testom (KS-test) te su varijable normalno distribuirane tj. ne odstupaju značajno od normalne raspodjele.

Tablica 1. Koeficijent intraclass korelacije (ICC), normalitet distribucije i deskriptivni pokazatelji ukupnog rezultata po česticama

	ICC	max D (K-S p)	AS	SD
T1L%L	0,921	0,165 (p>0.20)	79,028	8,432
T1L%D	0,921	0,157 (p>0.20)	20,806	8,203
T1LCOFTTW	0,977	0,188 (p>0.20)	73,167	22,645
T1D%L	0,933	0,084 (p>0.20)	33,347	7,246
T1D%D	0,933	0,084 (p>0.20)	66,653	7,246
T1DCOFTTW	0,984	0,207 (p>0.20)	51,736	14,600
TIAPL%L	0,909	0,117 (p>0.20)	77,764	8,062
TIAPL%D	0,909	0,117 (p>0.20)	22,236	8,062
TIAPLCOFTTW	0,975	0,164 (p>0.20)	70,222	20,755
TIAPD%L	0,941	0,124 (p>0.20)	34,181	8,566
TIAPD%D	0,941	0,124 (p>0.20)	65,819	8,566
TIAPDCOFTTW	0,984	0,208 (p>0.20)	63,917	17,972

Legenda: ICC-koeficijent intraklasne korelacije; max D-maksimalno odstupanje; K-S p-Kolmogorov-Smirnov test ; AS- aritmetička sredina; SD-standardna devijacija, T1-prvi test, L-lijevo, D-desno, COFTTW- prijeđeni put točke projekcije centra težišta tijela unutar površine oslonca, TIAP- test s podizanjem IAP-a

U tablici 2 definirane su varijable razlika i njihovi deskriptivni pokazatelji pri podizanju lijeve i desne noge. Rezultati pokazuju da se s IAP-om prijeđeni put točke projekcije centra težišta tijela unutar površine oslonca smanjuje

kada ispitanici podižu lijevu nogu. Kada podižu desnu nogu ispitanici su stabilniji, a prijeđeni put se povećava što nije statistički značajno utjecalo na razliku među grupama. Autori pojedinih istraživanja dokazuju da povećan IAP povećava stabilnost kralježnice (Hodges i sur., 2005.). Ovi podaci su u skladu s hipotezom da modulacija IAP-a tijekom funkcionalnih zadataka doprinosi mehaničkoj stabilnosti kralježnice. Stabilnost kralježnice pod opterećenjem povećava asimetrije i zahtijeva angažiranost više mišića što je potrebno za stabilizaciju kralježnice u asimetričnim uvjetima (Granata, Wilson, 2001.).

Tablica 2. Deskriptivni pokazatelji varijabli razlika parametara u testu fleksije u zglobu kuka lijeve i desne noge u sjedećem položaju, ukupnih rezultata i po grupama (ng0=13, ngIAP=11)

	n	max D	K-S p	AS	SD	ASg0	SD g0	AS gIAP	SD gIAP
DIFF L%L:	24	0,122	p > .20	-1,26	5,96	0,00	5,893	-2,76	5,959
DIFF L%D:	24	0,127	p > .20	1,43	5,83	0,00	5,893	3,12	5,542
DIFF LCOFTTW:	24	0,096	p > .20	-2,94	7,45	-3,95	6,137	-1,76	8,927
DIFF D%L:	24	0,107	p > .20	0,83	5,11	1,05	4,312	0,58	6,127
DIFF D%D:	24	0,107	p > .20	-0,83	5,11	-1,05	4,312	-0,58	6,127
DIFF DCOFTTW:	24	0,095	p > .20	12,18	4,54	11,82	4,086	12,61	5,202

Legenda: n-broj ispitanika; max D-maksimalno odstupanje; K-S p-Kolmogorov-Smirnov test, AS- aritmetička sredina; SD-standardna devijacija, g0 -grupa koja nije sposobna svjesno podići IAP, gIAP -grupa koja je sposobna svjesno podići IAP, DIFF – varijable razlika parametara, L-lijevo, D-desno, COFTTW- prijeđeni put točke projekcije centra težišta tijela unutar površine oslonca

Za utvrđivanje razlika među grupama po diskriminacijskoj funkciji i koliko pojedine varijable pridonose toj razlici primjenjena je diskriminativna kanonička stupnjevita (forward) analiza.

Tablica 3. Diskriminativna kanonička stupnjevita (forward) analiza

	DF1	Wilks' λ	F (1,20)	p
DIFF L%L	-0,317	0,776	4,592	0,045
DIFF L%D	0,370	0,824	6,103	0,023
DIFF LCOFTTW	0,198	0,831	6,342	0,020
Cg0	-0,673			
CgIAP	0,796			
λ	Can R	Wilks' λ	χ²	p
0,585	0,607	0,631	9,438	0,024

Legenda: DIFF-varijable razlika parametara, L-lijevo, D-desno, COFTTW- prijedeni put točke projekcije centra težišta tijela unutar površine oslonca, Cg0 -centroid grupe koja nije sposobna svjesno podići IAP, CgIAP -grupa koja je sposobna svjesno podići IAP, DF1- diskriminativna funkcija, Wilks' λ –Wilksova Lambda, F-vrijednost, p-razina značajnosti, CanR-kanonička korelacija, χ²- Chi-square test

Struktura diskriminacijske funkcije odnosno korelacije varijabli s pripadajućom diskriminacijskom funkcijom, pokazuje da su tri varijable izdvojene kao značajne u razlikovanju grupa i to varijable testa s podizanjem lijeve noge. Dvije varijable su na pozitivnom polu diskriminacijske funkcije, a jedna na negativnom. Nužan uvjet posturalne stabilnosti je da su vertikalna projekcija centra mase cijelog tijela i centar pritiska unutar površine oslonca. Tijekom sjedenja ima manje pomaka od ravnotežnog položaja tijekom kratkih vremenskih intervala, manje kontrolne prilagodbe dugoročno donijeti sustav u ravnotežu (Vette i sur., 2010.). Stabilnost tijela se poboljšava ako se poveća površina oslonca ili spuštanjem centra mase. Grupa koja je sposobna svjesno podići IAP ima pozitivne promjene prijedjenog puta točke projekcije centra težišta tijela unutar površine oslonca što možemo vidjeti i u prethodnoj tabeli u AS po grupama. Smanjena kontrola trupa je čimbenik koji doprinosi sportskim ozljedama kralježnice kao i segmentima kinetičkog lanca (Zazulak i sur., 2008.), a primjenom kvalitetne stabilnosti trupa u koordinaciji s IAP-om prevenirao bi se nastanak disfunkcija tijekom vježbanja.

ZAKLJUČAK

Grupa koja je sposobna svjesno podići IAP ima pozitivne promjene prijeđenog puta točke projekcije centra težišta tijela unutar površine oslonca. Ispitanici koji su sposobni svjesno podići IAP abdominalnim disanjem imaju bolju stabilnost kralježnice kada podignu desnu nogu. Ispitanici u ovom istraživanju su početnici u abdominalnom disanju, a za sljedeća istraživanja ispitanici bi trebali proći mjesečni tretman učenja vještine abdominalnog disanja. Na taj način imali bi kontrolirani eksperiment u kojem bi bili ispitanici koji su što sličniji u vještini abdominalnog disanja i takvim disanjem sposobni podići intraabdominalni pritisak (IAP).

LITERATURA

Cholewicki, J., Juluru, K., & McGill, S. M. (1999). Intra-abdominal pressure mechanism for stabilizing the lumbar spine. *Journal of biomechanics*, 32(1), 13-17.

De Keulenaer, B. L., De Waele, J. J., Powell, B., & Malbrain, M. L. N. G. (2009). What is normal intra-abdominal pressure and how is it affected by positioning, body mass and positive end-expiratory pressure?. *Intensive care medicine*, 35(6), 969-976.

Frank, C., Kobesova, A., & Kolar, P. (2013). Dynamic neuromuscular stabilization & sports rehabilitation. *International journal of sports physical therapy*, 8(1), 62.

Granata, K. P., & Wilson, S. E. (2001). Trunk posture and spinal stability. *Clinical biomechanics*, 16(8), 650-659.

Hodges, P. W., Eriksson, A. M., Shirley, D., & Gandevia, S. C. (2005). Intra-abdominal pressure increases stiffness of the lumbar spine. *Journal of biomechanics*, 38(9), 1873-1880.

Kisner, C., Colby, L. A. (2007). Therapeutic exercise: foundations and techniques, FA Davis Company Philadelphia.

Kolář, P. (2006). Facilitation of agonist-antagonist co-activation by reflex stimulation methods. Liebenson C. *Rehabilitation of the Spine, 2nd Edition*. Baltimore: Lippincott/Williams and Wilkins, 531-565.

Kolář, P., Šulc, J., Kynčl, M., Šanda, J., Čakrt, O., Andel, R., ... & Kobesová, A. (2012). Postural function of the diaphragm in persons with and without chronic low back pain. *journal of orthopaedic & sports physical therapy*, 42(4), 352-362.

Kolář, P. (2013). Clinical Rehabilitation. Alena Kobesová.

McGill, S. M., Norman, R. W., & Sharratt, M. T. (1990). The effect of an abdominal belt on trunk muscle activity and intra-abdominal pressure during squat lifts. *Ergonomics*, 33(2), 147-160.

Milardović, M., Paušić, J., & Kuzmanić, B. (2014). Differences in body posture and balance in children of classroom teaching attending and not attending extended stay. *International Journal of Scientific Issues in Physical Education, Sport & Health*, 3(2), 135-140.: Faculty of Physical Education, Sport, and Health, University in Skopje.

Sugrue, M. (1995). Intra-abdominal pressure. *Clinical Intensive Care*, 6(2), 76-79.

van Dieën, J. H., Koppes, L. L., & Twisk, J. W. (2010). Postural sway parameters in seated balancing; their reliability and relationship with balancing performance. *Gait & Posture*, 31(1), 42-46.

Vette, A. H., Masani, K., Sin, V., & Popovic, M. R. (2010). Posturographic measures in healthy young adults during quiet sitting in comparison with quiet standing. *Medical engineering & physics*, 32(1), 32-38.

Zazulak, B., Cholewicki, J., & Reeves, N. P. (2008). Neuromuscular control of trunk stability: clinical implications for sports injury prevention. *Journal of the American Academy of Orthopaedic Surgeons*, 16(9), 497-505.

.....

SESSION TRENDS IN PHYSICAL EDUCATION
SEKCIJA TRENDOVI U TJELESNOJ I ZDRAVSTVENOJ KULTURI

.....



Keynote speaker

Interpersonal communication in education - kinesiological perspective

Tonči Bavčević

Faculty of Kinesiology, University of Split, Croatia

ABSTRACT

This paper contains kinesiological view of the importance of interpersonal communication in education. Influence of quality of communication on implementation of teaching process of physical education was particularly analysed. The role of teacher in the process of communication was also analysed, as well as the importance of mutual cooperation of all participants of the process. Also, the internal structure of communication process was analysed, and practical directions for improvement of teaching communication and the process of education as a whole were outlined as well.

Key words: communicology, kinesiological education, kinesiological didactics

EDUCATION AS A COMMUNICATION PROCESS

All human relations in their genesis require an establishment of a certain form of communication, and process of education is no exception. If we focus on institutionalised form of education that is school system, it is easy to detect existence of different communication levels between subjects of educational process. The most obvious direction of communication is the one between teachers and students and between students themselves, but it is important not to neglect the communication between teachers and parents, between teachers themselves, between parents and children, communication of school as a wider environment etc.

It is obvious that the process of education is essentially a communication process. Communication thereby appears not only as means of establishing relations but also as a way of keeping it (TončiBavčević, Babin, TeoBavčević, 2012).

Namely, once established relation may be kept only by keeping quality process of communication between its participants. According to the mentioned education as well requires keeping long-term quality cooperative relations, where communication plays a crucial part. Will students accept school and teachers and will they truly be ready to develop a system of values depends significantly on quality of relations which dominate in educational environment. In other words, quality of education will directly depend on the quality of communication which in a longer term generates between subjects of teaching process.

It is clear from the mentioned that the process of communication itself includes a number of subjects. Still, the role of teachers as moderators of the educational process appears accordingly as a crucial factor, so the role of a teacher as a communicator is the greatest (Johnson & Roellke, 1999; Swann, 2002). It is therefore important that teachers are aware of the role they have in educational process and of the importance which communication thereby has. Namely, the role of teachers is not only the transfer of factual knowledge written within curriculum, or even development of skills which come out of it. On the contrary, primary role of a teacher is creating relations of trust which will ensure preconditions for accepting new values and knowledge and in the end enabling the process of maturing and forming of a child in its full potential (Bavčević, 2012).

KINESIOLOGICAL EDUCATION AND COMMUNICOLOGY

In its development kinesiology differentiated itself from the field of anthropological sciences as a science and a profession. It is no surprise therefore that in methodological approach without doubt it relies on classic approach of human studying. On one hand it ensured kinesiology necessary preconditions for clear formation of subjects and goals as well as work methods, and on the other hand it ensured defining applicable work fields from kinesiological education and sports to kinesiological recreation and kinesitherapy.

Kinesiological education itself definitely owes its existence to kinesiology as a substrate science, but in its development it inevitably meets and intersects with other sciences and disciplines without which modern communication is unthinkable. One of those sciences is definitely interpersonal communicology which today appears more and more as a basis of studying and of development of educational process. So, modern kinesiological didactics relies significantly on knowledge of interpersonal communicology as a science, thereby

using knowledge on methods and modalities of communication as a crucial factor in implementation of the teaching process.

Repertoire of operators, disposed by kinesiology, ensures an extreme potential for development of anthropological status of children in the field of education. Will it, however, really come to that development does not only depend on the content of curriculum, but it also depends on involvement of teachers to interest students in content offered to them within the programme. Only if they accept the value of what is taught and the benefit of learning itself, students may be equal partners in the process of education. In other words it is necessary that students accept values of physical exercise as their own internalised value, and a precondition to that is accepting school as institution and teachers as persons.

From the mentioned it is entirely clear that achieving goals of kinesiological education is possible only within the context of quality relations between all subjects of the teaching process and it means establishing and keeping quality and cooperative communication. Accordingly, the role of teachers is clearly emphasised and the final work result will depend on their skills and readiness to ensure the mentioned preconditions (Kerssen-Griep, Hess & Trees, 2003; Mottet, Martin & Myers, 2004; Özay, Kaya & Sezek, 2004; Ratliffe & Hudson, 1987).

INTERPERSONAL COMMUNICATION – A MISSING LINK

Considering the role of kinesiological education as an integrative part of education, especially if we take into consideration a fact of representation of the subject physical education throughout the entire educational vertical, it can be clearly seen how important this work field is. Therefore, it is significantly important to ensure all preconditions in order to really achieve goals and tasks during kinesiological education, and which could really be expected according to the representation of the subject in curriculum.

Question which is consequently raised is what work modalities may enable optimisation of the process of education in general, and of kinesiological education as well. Namely, from anthropological point of view movement is biologically immanent to a human being, so it is logical to expect that children will spontaneously accept contents of physical education. Still, this fact should not be taken for granted, especially in the context of permanent changes within society which affect institutionalised form of education as well. In other words,

in the context of changed social relations and ever growing interference of other contexts to which children are exposed, school faces new challenges. Questions, raised from the mentioned, are questions of motivation of students for official teaching curriculums and for school in general. Accordingly, kinesiological education is not deprived of such questions. Challenge set by the society in front of school these days is much higher than before, and future will surely bring new challenges as well (Bavčević&Miletić, 2015). From curriculums with set contents to forming a person is a long way, which assumes creation of optimal work conditions, from material to contextual. From kinesiological point of view it implies continuous improvement of work methods, weather it is teaching methods, learning methods or exercising methods.

According to the mentioned, it is quite clear that the role of teachers in the entire educational contexts is crucial (Frymier& Houser, 2000; Patrick, Anderman, Ryan, Edelin&Midgley, 2001; Reed, McLeod & McAllister, 1999; She & Fisher, 2002). Namely, will students really accept culture of physical exercising and of a healthy way of life as a lifestyle will finally depend on the system of values which will gradually settle during the course of growing up as a part of their own identity. It is easy to make a possible conclusion that setting thereby a cooperative relation on relation student-teacher will represent a crucial factor in internalisation of values which we tend to transfer to our students, and such relation requires setting of a long term quality communication between subjects of the teaching process. In other words, communication represents a basic mean of modification of human behaviour, and also within school as institution. Good communication climate in which students feel safer, equal and accepted from colleagues, teachers and other subjects of the teaching process is a basic precondition to education.

Kinesiological education faces same challenges. Imperative set in front of kinesiology today in general, as well in front of physical education, is to create environment of trust and safety which enables a child to show its own identity regarding skills, abilities, knowledge, attitudes, etc. Generally, educational frames must allow free expression of child's individuality, and it requires setting of democratic relations to its full extent (Brajša, 1995). Freedom of communication and creating a non-threatening communication atmosphere are equally important in physical education as in any other school subject. Moreover, since entire human being, that is the total of its anthropological values, is exposed to transformation within physical education, it is possible that in such process a child may feel threatened or less valuable. Therefore, it is particularly import-

ant in physical education to ensure a child with an individualised approach according to child’s objective possibilities. It puts in front of teachers a quite demanding task, but also a challenge which requires a dedicated work, continuous communication with children and ensures environments which will enable students to achieve real potentials (Babin, Bavčević, Vlahović, 2005).

Except the mentioned it is important to have in mind the internal complexity of the communication process which comes from the fact that it generates itself in the interspaces between co-speakers of different psycho-sociological status (scheme 1). In other words conversation as a product of human mind is extremely submissive to a subjective experience of reality, so the destiny of communication process is significantly determined by the coordination between its participants. It is entirely possible that due to individual specificities and differences between co-speakers significant difference appears in interpreting the message (Brajša, 1994). Such situation will significantly make difficult the understanding during the conversation, it will even disable the flow of communication. Described appearance is particularly important in the process of communication in teaching in which we can assume with great possibility that there are significant differences in structure of personality of co-speakers. Namely, it is not possible to expect that in the process of development children will have the same feeling of reality as their teachers. Many problems in communication may come out of those differences which are afterwards reflected on interpersonal relations and, finally, on the efficiency of the process of education itself. All this indicates the importance of knowing the flow of communication and of its complexity, in order for us to prevent possible difficulties as moderators and to ensure on time the optimal communicative atmosphere.

TRENDS IN PHYSICAL EDUCATION
TRENDOVI U TELESNOJ I ZDRAVSTVENOJ KULTURI

Scheme 1

General cybernetic model of interpersonal communication (Bavčević, 2010).

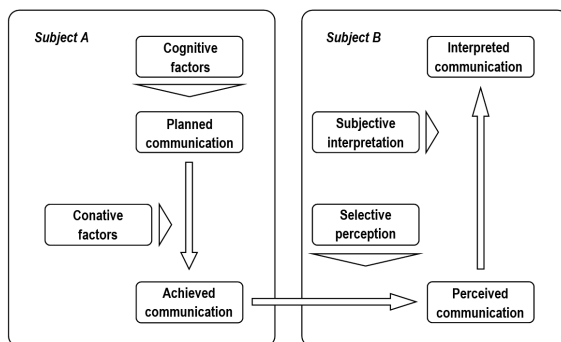

FROM KINESIOLOGICAL OPERATOR TO KINESIOLOGICAL COMMUNICOLOGY

Considering the process of kinesiological education as an integrative part of the educational system we can clearly see the importance of this field for entire development of all anthropological dimensions of a child. Comparative advantages of kinesiological education are really seen from the possibility to act on entire human being from morphological characteristics, motor and functional abilities, cognitive and conative dimensions, social status to the system of knowledge, skills and attitudes. However, in order to complete the mentioned tasks it is necessary to go through a long and complex journey between content that is operators, disposed by kinesiology, to acceptance of kinesiological culture as a lifestyle by students. It is possible to overcome this methodological and demanding gap only with long term work which includes entire spectrum of procedures from the fields of kinesiological didactics like work methods, methodical procedures, methodical organisational work forms, etc. However all mentioned steps necessarily take place within a particular educational context, and it is defined by the quality of human relations of all subjects from the process of education. Interpersonal communication appears in that context as a main mean of setting and keeping quality cooperative relations, regardless the level and number of involved subjects. Success of the entire process of education will, therefore, depend on the quality of communication (Bavčević, Babin, Vlahović, 2005).

Process of communication, however, is not a simple or one way process. Moreover, interpersonal communication is an extremely complex and dynamic multidimensional appearance which arises from interaction between people. Different communicology schools describe different models of communication, but maybe for understanding the complexity of the process of communication in the field of education the most adequate model is the Hamburg communicology school (Schulz Von Thun, 2001a, 2001b, 2002). According to this model interpersonal communication is formed by four dimensions: fact, relationship, self-revealing and appeal (scheme 2).

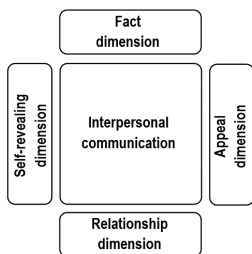

Scheme 2

Hamburg communication square (Bavčević, 2010).

The fact dimension of communication refers to the transfer of information between participants to a conversation. From the aspect of educational paradigm this form of communication is clearly obvious and represents a transfer of factual knowledge from teacher to student. Frequently, communication is wrongly compared to this communicative dimension. If, however, communication in teaching was left only on the fact level it would be hard for the sent information to obtain any change in student's being. Namely, the information itself excluded from a wider human relations context has very low chances to be internalised into a certain system of values of a person to whom it was intended. All mentioned, of course, does not diminish the importance of the fact dimension of communication without which the transfer of knowledge is not possible at all. Therefore it is quite important for a teacher to present information to students in an appropriate and interesting way, having in mind age and previous knowledge of persons they work with, complexity of educational content, etc.

Relationship dimension of communication includes the process of defining interpersonal relations between subjects involved in communication, but defining relations according to content which is communicated. In other words, consciously or unconsciously, planned or not planned, in conversation we necessarily manifest our attitudes on co-speaker as well as on the topic of conversation itself. On the relational side of communication our appreciation of co-speaker, affection, empathy, etc. is outlined. Namely, destiny of a sent message on the factual level significantly depends on the quality of interpersonal relations generated within relationship communication. In communication in teaching the necessity of setting cooperative relations marked by interpersonal appreciation and acceptance is implied. Therefore, it is extremely important that a teacher as a moderator of entire process is aware of this dimension of communication, because finally the success of a conversation during the lesson will depend on it, and it will thereby result in the process of education as a whole.

The self-revealing dimension of communication refers to an aspect of communication process in which communicator reveals himself to another person. Namely, from each conversation we may find out plenty on our co-speaker. This part of communication is most frequently unaware and planned, but it significantly influences the flow of communication process. Generally, co-speakers recognize open communication and react positively to persons of such communicative style. Teachers, however, frequently depersonalize commu-

nication because they fear that too personal communication may endanger their teaching authority, which frequently makes the teaching process harder. Mentioned fear, of course, is not entirely unsupported, since personal communication opens us to co-speakers and to a certain extent makes us vulnerable on personal plan. Therefore, it takes a lot of experience and knowledge to find the right balance in personal communication which on one side allows the teacher showing their own identity, and on the other side it allows the teacher to keep control in managing the teaching process.

The appeal dimension of communication is a part of communication in which communicator tries to perform a change in co-speaker. From the aspect of education this segment of communication corresponds to the goal of education itself and which unavoidably includes changes in person of a student in different spheres of their being. In other words, the teacher will always try to provoke a certain change with communication, weather it is to build knowledge, skills, and attitudes or even to define motivational structure. Regardless the aspect of the change, the process of education always includes an effort to challenge change. Will that change really happen depends on a whole range of factors, but from the communicology aspect a precondition for achieving this goal lies in the first place in coordination of communication dimensions.

TEACHING PROCESS OR COMMUNICATION PROCESS?

Answer to the previously set question is basically really simple. Namely, teaching process is a process of communication in its genesis. In other words, from the communicology aspect teaching may be defined as a process of exchanging information and defining interpersonal relations between educational subjects, and by means of interpersonal communication (Bavčević, 2010). If we analyse the process of communication in the light of previously described communication dimensions, we will notice that during educational process there are all segments of communications, from content transfer and defining of relations between the subjects to revealing identity and intention to change the co-speaker's behaviour.

In doctoral dissertation Bavčević (2010) sets up a model of connection of interpersonal communication and the quality of teaching process on the level of a lesson of physical education. Defined model includes three communication dimensions: technical-content dimension, dimension of assertion and formality and dimension of empathy and intimacy (scheme 3). Significant in-

fluence of interpersonal communication on the quality of implementation of a lesson of physical education as a whole as well as of its integrative parts was confirmed without any doubt by analysing the model in teaching practice. It all implies the importance of the quality of communication with students with aim to set good cooperative relations and to create preconditions to implementation of the teaching process. Accordingly, in the structure of communication there are different segments of communication which, in synergistic act, form a good conversation.

Scheme 3

Connection of the teaching process and interpersonal communication (Bavčević, 2010).

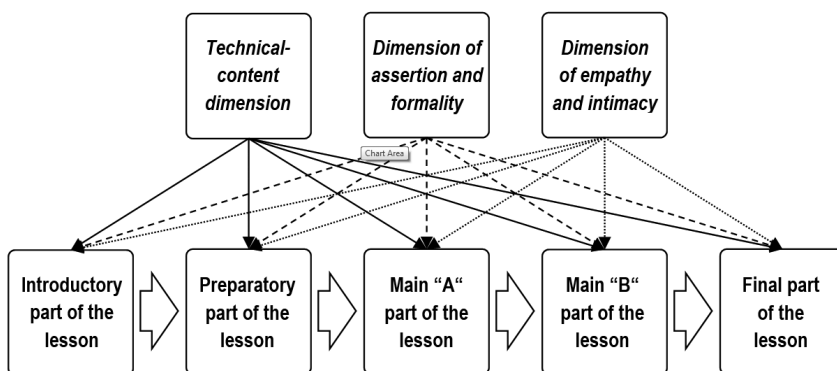

From all the mentioned it can be concluded that interpersonal communication represents *conditio sine qua non* of a successful process of education. In other words, the process of education is possible only within the context of quality human relations which are generated between different subjects of the educational process, and the key of creating those relations lies in the process of communication. Separating the teaching process from the process of communication is simply not possible, because conversation is at the same time a mean and a goal of education. On one hand it enables interaction between individuals and exchange of knowledge, experience and attitudes, and on the other hand it ensures preconditions for personal growth. Therefore, it is rather clear that basic tool of each teacher is the ability to communicate. This fact opens numerous chances to teachers and teaching profession. Possibility to influence the formation of a human being is an extreme gift, but also a calling to an extreme responsibility. People have a task to use the possibilities we have with only one goal– for the welfare of a human being.

REFERENCES

Babin, J., Bavčević, T., & Vlahović, L. (2005). Analiza interstrukturnih komunikacijskih relacija. In V. Findak (Ed.), *Zbornik radova 14. ljetne škole kineziologa Republike Hrvatske – Informatizacija u područjima edukacije, sporta i sportske rekreacije, Rovinj, 2005* (pp. 61-64). Zagreb: Hrvatski kineziološki savez.

Bavčević, T. (2010). Analiza povezanosti dimenzija interpersonalne komunikacije i kvalitete nastavnog procesa u kineziološkoj edukaciji. (doctoral dissertation, Faculty of Kinesiology, University of Split; mentor: Babin, Josip; co-mentor: Prskalo, Ivan).

Bavčević, T., & Miletić, Đ. (2015). Primjena i utjecaj novih tehnologija na kvalitetu učenja. In V. Findak (Ed.), *Zbornik radova 24. ljetne škole kineziologa Republike Hrvatske – Primjena i utjecaj novih tehnologija na kvalitetu rada u područjima edukacije, sporta, sportske rekreacije i kineziterapije, Poreč, 2015* (pp. 71-81). Zagreb: Hrvatski kineziološki savez.

Bavčević, T. (2012). Influence of the interpersonal communication on the perception of the physical education teaching process. In Đ. Miletić, S. Krstulović, Z. Grgantov, T. Bavčević & A. Kezić (Eds.), *Proceedings Book of the 4th International Scientific Conference "Contemporary Kinesiology", Split, 2012*. (pp. 594-601). Split: Faculty of Kinesiology, University of Split.

Bavčević, T. [Tonči], Babin, J., & Bavčević, T. [Teo] (2012). Interpersonalna komunikacija – čimbenik kvalitete i intenzifikacije nastavnog procesa. In V. Findak (Ed.), *Zbornik radova 21. ljetne škole kineziologa Republike Hrvatske – Intenzifikacija procesa vježbanja u područjima edukacije, sporta, sportske rekreacije i kineziterapije, Poreč, 2012*. (pp. 81-87). Zagreb: Hrvatski kineziološki savez.

Bavčević, T., Babin, J., & Vlahović, L. (2005). Komunikološki aspekti nastave tjelesne i zdravstvene kulture. In V. Findak (Ed.), *Zbornik radova 14. ljetne škole kineziologa Republike Hrvatske – Informatizacija u područjima edukacije, sporta i sportske rekreacije, Rovinj, 2005*, (pp. 56-60). Zagreb: Hrvatski kineziološki savez.

Brajša, P. (1994). *Pedagoška komunikologija*. Zagreb: Školske novine.

Brajša, P. (1995). *Sedam tajni uspješne škole*. Zagreb: Školske novine.

Frymier, A.B., & Houser, M.L. (2000). The teacher-student relationship as an interpersonal relationship. *Communication Education*, 49 (3), 207-219.

Johnson, S.D., & Roellke, C.F. (1999). Secondary teachers' and undergraduate education faculty members' perceptions of teaching-effectiveness criteria: A national survey. *Communication Education*, 48 (2), 127-138.

Kerssen-Griep, J., Hess, J.A., & Trees, A.R. (2003). Sustaining the Desire to Learn: Dimensions of Perceived Instructional Facework Related to Student Involvement and Motivation to Learn. *Western Journal of Communication*, **67** (4), 357-381.

Mottet, T.P., Martin, M.M., & Myers, S.A. (2004). Relationships among perceived instructor verbal approach and avoidance relational strategies and students' motives for communicating with their instructors. *Communication Education*, **23** (1), 116-122.

Özay, E., Kaya, E., & Sezek, F. (2004). Application of a Questionnaire to Describe Teacher Communication Behaviour and its Association with Students in Science in Turkey. *Journal of Baltic Science Education*, **6**, 15-21.

Patrick, H., Anderman, L.H., Ryan, A.M., Edelin, K.C., & Midgley, C. (2001). **Teachers' Communication** of Goal Orientations in Four Fifth-Grade Classrooms. *Elementary School Journal*, **102** (1), 35-58.

Ratliffe, S.A., & Hudson, D.D. (1987). A Description of a Student-Staffed, Competency-Based Laboratory for the Assessment of Interpersonal Communication Skills. *American Association for Higher Education Assessment Forum*, (pp. 21).

Reed, V.A., McLeod, K., & McAllister, L. (1999). Importance of Selected Communication Skills for Talking With Peers and Teachers. *Language, Speech, & Hearing Services in Schools*, **30** (1), 32-50.

Schulz Von Thun, F. (2001a). *Kakomeđusobnorazgovaramo 1, Smetnjeirazrješenja, Općapsihologijakomunikacije*. Zagreb: Erudita.

Schulz Von Thun, F. (2001b). *Kakomeđusobnorazgovaramo 3, „Unutarnji-tim“ ikomunikacijaprimjerenasituaciji, Komunikacija - ličnost - situacija*. Zagreb: Erudita.

Schulz Von Thun, F. (2002). *Kakomeđusobnorazgovaramo 2, Stilovivrijednos-tiirazvitakličnosti, Diferencijalnapsihologijakomunikacije*. Zagreb: Erudita.

She, H.C., & Fisher, D. (2002). Teacher communication behavior and its association with students' cognitive and attitudinal outcomes in science in Taiwan. *Journal of Research in Science Teaching*, **39** (1), 63-78.

Swann, E. (2002). Communicating Effectively as a Clinical Instructor. *Athletic Therapy Today*, **7** (5), 28-33.

Rodna jednakost ili različitost na fotografijama hrvatskog sportskog časopisa “Sportske Novosti”

Ana Penjak, Hrvoje Karninčić

Kineziološki fakultet, Sveučilište u Splitu

ABSTRACT

The first aim of this study is to present the data on the analysis on differences between men and women illustrations in the sports magazine «Sportske novosti». The article takes into consideration the participation of gender in sport, in general. The second aim is to establish gender differences in media in the period 2009. (January and February) and 2014. (January and February). All the data (sample of 113 issues of the «Sportske novosti») have been collected in the University library, Split. The sample of variables consisted of 6 variables: dominant illustrations on the covers male/female (M/F); small illustrations on the covers (M/F); total amount of illustrations (M/F). In all 113 issues, there is just 1 woman illustration on the cover. Although there are 17% of female athletes in Croatia, women do not exceed 10% of illustrations, in general. Except statistically significant differences between participation of male and female athletes in sport, it seems that women have been marginalised in media, as well ($p < 0.001$ in 2009. and 2014.) with the approximation of the expected frequencies. There are statistically significant differences in the number of men illustrations between 2009. issues and 2014. issues. The difference is due to less number of magazine pages, and not to more female illustrations. Croatia, like many other countries in the world, follows the trend of inadequate female illustrations in sport media.

Key words: media, gender equality, illustrations, sport, women.

Uvod

«Rod ima dublje značenje u ljudskim životima, ali jedno od najprisutnijih je ono koji utječe na nejednako poimanje pojedinaca.» (Ridgeway, 2011) Bor-

ba za ravnopravnost spolova u različitim društvenim sferama je proces koji je i dalje prisutan (Rhode, 1999; Ridgeway, 2011). Na primjer, zastupljenost žena u različitim aspektima vezanim uz sport vrlo je zabrinjavajuća. Danas je sport u medijima namijenjen prvenstveno muškarcima, bijelcima, a isključujući je prema ženama i manjinama (Cohen, 2011; Woods, 2014). Muški boks, nogomet, i Formula 1 sačinjavali su 86% jednog Francuskog televizijskog programa (Bodin, Robène, Héas, 2005). Zastupljenost žena u sportskim medijima je poražavajuća. Muškarci su u 95% zastupljeni u sportskim časopisima, dok su žene zastupljene u 5%, pa i manje u nekim aspektima (Bishop, 2003; Engleman A, Pedersen P.M, R, 2009; Weber, Carini, 2013). Iako borba za ravnopravnost spolova ima dugu tradiciju, jak patrijarhalni utjecaj je duboko ukorijenjen, kako u svijetu tako i u Hrvatskoj. Mediji su ti koji bi mogli odigrati značajnu ulogu u razvoju ravnopravnost spolova, ali umjesto toga upravo oni često još više doprinose produbljivanju neravnopravnosti. Dok su članci o ženskim sportskim uspjesima su rijetki, dodatni problem stvaraju nekorektna izvještavanja. Na primjer, fotografije povezane sa člancima često su više fokusirane na tjelesnu ljepotu nego na temu samog članka (Daniels, 2009; Gurrieri, Previte, Brace-Govan, 2013; Thomsen, Bower, Barnes, 2004) što naravno dodatno trivijalizira bavljenje sportom kod žena. Upravo iz tog razloga bilo bi zanimljivo provjeriti da li i u hrvatskim medijima ima slika koje su seksistički orijentirane, (fokusirane na određene dijelove ženskog tijela). Čudni su razmjeri zastupljenosti žena u sportskim medijima s aspekta zastupljenosti žena na Olimpijskim igrama. Na posljednjim Olimpijskim igrama bilo je 40.3% ženskih predstavnika i nastupile su u 44.2% Olimpijskih disciplina (IOC, 2014), dok su omjeri pojavljivanja sportašica u medijima mnogo niži. Novija istraživanja ukazuju na problem objektivnosti prikazivanja prisutnosti žena u medijima (Delorme, 2014). Problemi su metodološke naravi. Naime, objektivno bi bilo da žene budu zastupljene u sportskim medijima proporcionalno koliko su zastupljene i u sportu. Na stranicama HOO-a može se vidjeti trenutna zastupljenost žena u Hrvatskom sportu: «U 2013. godini u Hrvatskoj je bilo 280.790 registriranih natjecatelja po svim dobnim skupinama, od čega tek 17 posto žena, vidljivo je to iz izvješća Komisije Hrvatskog olimpijskog odbora (HOO) za žene u sportu za prošlu godinu.» (Žene u sportu podzastupljene, HOO, 2014)

Pitanja koja se postavljaju su: jesu li i u kojoj su mjeri žene (pod)zastupljene u dnevnom listu «Sportske novosti» u odnosu na stvaran broj žena u sportu u Hrvatskoj; na koji su način sportašice u «Sportskim novostima» prikazane; je li odnos medija, općenito, prema ženama u Hrvatskom sportu različit

od odnosa medija prema ženama u svijetu? «Sportske novine» su dnevni list, najpopularniji i najtiražniji sportski časopis u Hrvatskoj koji je, uz elektronske medije, glavni izvor informacija iz područja sporta. Stoga, pretpostavka je da kroz uvid u ovaj oblik tiskanog medija možemo dobiti sliku o zastupljenosti i (ne)ravnopravnosti spolova u sportskim tiskanim medijima, u Hrvatskoj.

Cilj ovog rada je utvrditi i analizirati razlike među spolovima kroz učestalost pojavljivanja u sportskim medijima s obzirom na opću zastupljenost određenog spola u sportu. Drugi cilj je utvrditi razlike u zastupljenosti spolova u medijima između 2009. i 2014. kako bi se ustanovili trendovi u Hrvatskoj. Treći cilj je utvrditi učestalost pojavljivanja nekorektnih prikaza (prvenstveno seksističkih) žena u časopisu.

METODE

Uzorak entiteta se sastoji od ukupno 113 brojeva časopisa «Sportske novosti» iz dva mjeseca 2009. (siječanj i veljača) i dva mjeseca 2014. (siječanj i veljača).

Uzorak varijabli sačinjava 6 varijabli: 1. Velike slike muškarca na naslovnici časopisa; 2. Velike slike žene na naslovnici časopisa; 3. Male slike muškarca na naslovnici časopisa; 4. Male slike žene na naslovnici časopisa; 5. Ukupan broj slika muškaraca u časopisu; 6. Ukupan broj slika žena u časopisu. Slike koje na neprimjeren (seksistički) način prikazuju žene u časopisu posebno su pobrojane.

Svi podatci su analizirani programom Statistics 11 (Statsoft, USA) i Microsoft Office Excel 2007. Zbog vrlo velikih razlika u broju objavljenih slika muškaraca i žena na naslovnici časopisa podatci su samo grafički prikazani. Za varijable, ukupan broj slika muškarci/žene podatci su obrađeni deskriptivnom statistikom (aritmetičke sredine i standardne devijacije); razlike između 2009. i 2014. testirane su T-testom, a kako je broj stranica manji 2014. u odnosu na 2009. varijable za T test su korigirane (broj slika / broj stranica). Kako bi se utvrdile razlike u učestalosti pojavljivanja muškaraca odnosno žena na slikama izračunat je Hi-kvadrat test. S obzirom da su žene u sportu u Hrvatskoj zastupljene s 17% natjecatelja, napravljena je aproksimacija očekivanih frekvencija.

REZULTATI

Ukupni broj analiziranih slika je 8869. Njihova distribucija, prema mjeseci, na naslovnicama časopisa prikazana je u Tablici 1.

Tablica 1. Broj slika u časopisu «Sportske novosti» za svaki analizirani mjesec

Slike	Siječanj, 2009.	Veljača, 2014.	Siječanj, 2014.	Veljača, 2014.	Ukupno
Ukupno	2444	2439	2121	1865	8869
Naslovnica	56	56	57	56	225

Slika 1. Slike na naslovnica časopisa «Sportske novosti» za mjesec siječanj - veljača 2009. te siječanj - veljača 2014.

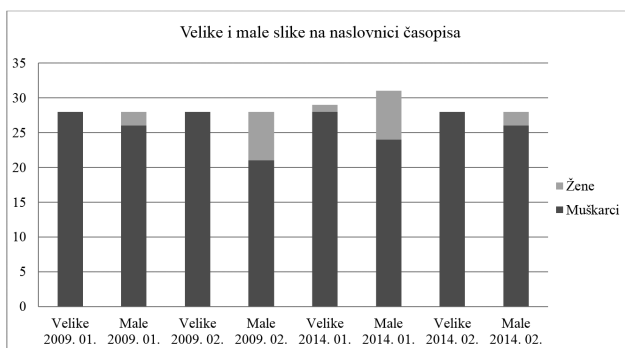

Iz Slike 1. možemo vidjeti očitu razliku u broju velikih slika na naslovnici između pojavljivanja muškaraca i žena i nešto manju razliku u broju malih slika na naslovnici.

Tablica 2. Deskriptivni statistički parametri (aritmetičke sredine i standardne devijacije AS±SD) za broj slika po mjesecima u časopisima, razlike (T test) između 2009. i 2014. kao i razlike u učestalosti pojavljivanja muškaraca odnosno žena na slikama u časopisima (Hi-kvadrat test), s aproksimacijom za žene od 17% i za muškarce od 83%.

Mjesec	(n)	Slika po broju	Spol	AS ± SD	% Žena	Hi-kvadrat test	p
Siječanj 2009.	28	85.3	Muško	79.2 ± 11.6	7.2	163.8	p < 0.001
			Žensko	6.1 ± 3.6			
Veljača 2009.	28	85.2	Muško	78.1 ± 13.6*	8.2	130.0	p < 0.001
			Žensko	7.0 ± 3.2			
Siječanj 2014.	29	72.6	Muško	67.0 ± 15.2	8.3	129.3	p < 0.001
			Žensko	6.0 ± 2.9			
Veljača 2014.	28	64.6	Muško	58.9 ± 10.7*	9.0	84.1	p < 0.001
			Žensko	5.8 ± 3.0			

*Statistički značajna razlika (t-test) između 2009. i 2014. p < 0.05

Iz Tablice 2. možemo vidjeti da postoje statistički značajne razlike između 2009. i 2014. (siječanj i veljača) za broj slika muškaraca na razini $p < 0.001$; vidljiva je statistički značajna razlika u učestalosti pojavljivanja muškaraca odnosno žena na slikama za sva četiri analizirana mjeseca na razini $p < 0.001$.

RASPRAVA

Istraživanjem je obuhvaćeno 113 brojeva časopisa «Sportske novosti». Samo se u jednom broju (siječanj, 2014., broj 23), na naslovnici, u velikom formatu, pojavila žena (Blanka Vlašić). Broj malih slika žene na naslovnici časopisa je također zanemariv u odnosu na pojavljivanje muškaraca. Bez obzira na aproksimaciju očekivanih frekvencija prema udjelu žena u sportu, istraživanje je pokazalo da su žene ipak statistički značajno podzastupljene u Hrvatskim sportskim medijima, za sve analizirane mjesece, na razini $p < 0.001$. Sve analizirane varijable ukazuju na neravnopravan položaj žena s obzirom na medijsku zastupljenost. Analiza razlika među godinama (2009./2014.) pokazala je da postoji statistički značajna razlika kod broja muškaraca na slikama za veljaču ($p < 0.05$). Broj muškaraca na slikama je značajno niži, dok se broj žena na slikama nije istovremeno značajno povećao (primjetan je blagi porast). Stoga, možemo pretpostaviti da je pad broja muškaraca na slikama uzrokovan smanjenjem broja stranica časopisa, a samim tim i ukupnog broja slika. Donekle možemo tvrditi da je prisutan blagi trend rasta zastupljenosti žena u sportskim medijima. Sličan trend rasta zabilježen je i u svijetu (Capranica et al., 2005; Delorme, 2014; Godoy-Pressland, Griggs, 2014). Osim po broju i veličini slika na naslovnici ili u samom časopisu, u literaturi se mogu naći radovi koji analiziraju korektnost prikaza žene u odnosu na muškarca. Ti radovi najčešće analiziraju kut kamere, pozu žene/muškarca na slici, fokusiranost na određeni dio tijela, ili primjerenost slike u odnosu na tekst (Daniels, 2009; Godoy-Pressland, Griggs, 2014; Gurrieri et al., 2013; Thomsen et al., 2004). Tijekom analize dokumentirano je 38 slika koje su neprimjerenog sadržaja. Navedene slike fokusirane su na grudi, stražnjicu, donje rublje ili nago žensko tijelo općenito. Takve slike uglavnom prikazuju navijačice, cure poznatih sportaša ili izbor za najljepšu sportašicu te uglavnom nemaju velike veze sa natjecanjem ili sportskim rezultatom. Ravnopravna zastupljenost spolova u medijima podložna je trendovima, tako je na primjer tijekom izvještaja američke televizijske mreže NBC na Olimpijskim igrama 2004. u udarnom terminu, samo se 6% odnosilo na vijesti o ženama, dvije godine ranije na zimskoj Olimpijadi 2002. u istom terminu taj postotak iznosio 16% (Billings, 2008; Billings, Angelini, 2007). Sličan je trend

žena na malim slikama na naslovnici časopisa u ovom istraživanju gdje je u siječnju 2009. vrlo nizak postotak, koji raste u veljači 2009. i siječnju 2014., da bi onda opet pao u veljači 2014. Kako je u ovom radu obuhvaćeno samo po dva mjeseca u navedenim godinama ove podatke treba oprezno tumačiti ali rad jasno ukazuje na problem rodne ravnopravnosti u sportskim medijima postoji te bi slično istraživanje trebalo provesti na većem uzorku i na više medija kako bi se stekla prava slika tog problema u Hrvatskoj.

ZAKLJUČAK

Istraživanje je provedeno s ciljem da se utvrde i analiziraju rodne razlike učestalosti pojavljivanja u sportskim medijima kao i pojavnost nekorektnih prikaza žena. Pregledano je 113 brojeva časopisa «Sportske novosti» i analizirano je 8869 slika. Istraživanje je pokazalo da su uz aproksimaciju od 17% (zastupljenost žena u sportu) žene ipak statistički značajno marginalizirane u sportskim medijima u Hrvatskoj. Prisutan je blagi trend rasta broja slika, ali je prisutan i određeni broj slika koje na neprimjeren način prikazuju žene. Ravnopravnost žene u sportu uvelike ovisi o medijima koji imaju moć utjecaja na javno mišljenje. Stoga, jako je važno da se procesi borbe za ravnopravnost spolova u ovom segmentu ubrzaju.

LITERATURA

Billings, A. C. (2008). Clocking Gender Differences: Televised Olympic Clock Time in the 1996-2006 Summer and Winter Olympics. *Television & New Media*, 9 (5), 429-441.

Billings, A. C., Angelini, J. R. (2007). Packaging the Games for Viewer Consumption: Gender, Ethnicity, and Nationality in NBC's Coverage of the 2004 Summer Olympics. *Communication Quarterly*, 55 (1), 95-111.

Bishop, R. (2003). Missing in Action: Feature Coverage. *Journal of Sport & Social Issues*, 27 (2), 184-194. Bodin, D., Robène, L., Héas, S. (2005). *Sport and Violence in Europe*: Council of Europe Pub.

Capranica, L., Minganti, C., Billat, V., Hanghoj, S., Piacentini, M. F., Cumps, E. & Meeusen, R. (2005). Newspaper Coverage of Women's Sports during the 2000 Sydney Olympic Games: Belgium, Denmark, France, and Italy. *Research Quarterly for Exercise and Sport*, 76(2), 212-223.

Cohen, S. (2011). *Folk Devils and Moral Panics*: Taylor and Francis.

Daniels, E. A. (2009). Sex Objects, Athletes, and Sexy Athletes: How Media Representations of Women Athletes Can Impact Adolescent Girls and College Women. *Journal of Adolescent Research*, 24 (4), 399-422.

Delorme, N. (2014). Were Women Really Underrepresented in Media Coverage of Summer Olympic Games (1984–2008)? An Invitation to Open a Methodological Discussion Regarding Sex Equity in Sports Media. *Mass Communication & Society*, 17 (1), 121-147.

Engleman A, Pedersen P. M, Wharton, R. (2009). Coverage by Gender in ESPN the Magazine - An Examination of Articles and Photographs. *International Journal of Sport Management* 10, 226-242.

Godoy-Pressland, A., Griggs, G. (2014). The photographic representation of female athletes in the British print media during the London 2012 Olympic Games. *Sport in Society*, 17 (6), 808-823.

Gurrieri, L, Previte, J, Brace-Govan, J. (2013). Women's Bodies as Sites of Control: Inadvertent Stigma and Exclusion in Social Marketing. *Journal of Macromarketing*, 33 (2), 128-143.

Hrvatski Olimpijski Odbor. (2014). Žene u sportu podzastupljene. Retrieved from <http://www.hoo.hr/hr/olimpizam/zene-u-sportu/2982-zene-u-sportu-podzastupljene>

International Olympic Committee. (2014). Factsheet Women In The Olympic Movement. Retrieved from http://www.olympic.org/Documents/Reference_documents_Factsheets/Women_in_Olympic_Movement.pdf

Rhode, L. D. (1999). *Speaking of Sex: The Denial of Gender Inequality*: Harvard University Press.

Ridgeway, C. L. (2011). *Framed by Gender: How Gender Inequality Persists in the Modern World*: Oxford University Press.

Thomsen, S. R., Bower, D. W., Barnes, M. D. (2004). Photographic Images in Women's Health, Fitness, and Sports Magazines and the Physical Selfconcept of A Group of Adolescent Female Volleyball Players. *Journal of Sport & Social Issues*, 28 (3), 266-283.

Weber, J. D., Carini, R. M. (2013). Where are the female athletes in Sports Illustrated? A content analysis of covers (2000–2011). *International Review for the Sociology of Sport*, 48 (2), 196-203.

Woods, R. (2014). *Social Issues in Sport* (2nd ed.). Illinois: Human Kinetics

Razlika u aktivnost na času sporta i tjelesnog odgoja

Faris Rašidagić¹, Edin Mirvić¹, Elvira Nikšić²

¹Fakultet sporta i tjelesnog odgoja, Univerzitet u Sarajevu, Bosna i Hercegovina

²Pedagoški fakultet, Univerzitet u Sarajevu, Bosna i Hercegovina

ABSTRACT

All students are not as active at Physical Education classes. Therefore, the teacher should encourage them to be more involved in the work. The aim of this study was to determine the difference in PE class activities, by monitoring the number of steps made by male and female. Both populations were working under the same conditions and using the same methodological organizational forms of work - polygons. The activity was monitored by using pedometers or tracking the number of steps taken during the hour. The number of steps is being turned into the traveled length. The sample in the study consisted of 57 students, of which 29 male and 28 female subjects. The obtained data were analyzed by ANOVA analysis, which showed that men made more steps and crossed a longer way than girls. As regards to the application of research results, we can conclude that teachers should anticipate hypokinesia of certain groups during the planning of sports and physical education and seek to overcome it.

Keywords: pedometer, step count, polygons, students

UVOD

Na razvoju nastave sporta i tjelesne aktivnosti neophodno je kontinuirano raditi, jer pozitivna antropološka transformacija nastaje pod uticajima tjelesne aktivnosti (Burgeson et al., 2000), što je i svrha ovog nastavnog procesa. Zbog pozitivne transformacije potreba za povećanjem tjelesne aktivnosti i način kako je organizovati i dalje ostaju izazov (Cale et al., 2006). Međutim,

kod organizacije i primjene tjelesnih aktivnosti prisutni su i ometajući faktori u smislu određenih razlika u shvaćanju i prihvaćanju potrebe za kretanjem. Sa populacijom koja razumije značaj potrebe za kretanjem je lakše raditi. Na primjer, ženska u odnosu na mušku populaciju, ozbiljnije shvata potrebu za kretanjem. To je uočeno u nekim provedenim istraživanjima (Mota et al., 2005) i konstatovano da se npr. tokom školskog raspusta djevojke više kreću od muškaraca. Međutim i pored obezbijeđenja jednakih uslova rada za mušku i žensku populaciju, ne moraju se uvijek javiti i isti nivoi aktivnosti (Groffik et al., 2008, Chan and Tudor-Locke, 2008., Armstrong and Welsman, 2006., Tudor – Locke i sur., 2006). Nastava sporta i tjelesnog odgoja je odlična prilika da se organizovano djeluje na polaznike, a na nastavniku sporta i tjelesnog odgoja je da, tokom perioda kada su mladi ljudi u školi i pod planiranim i programiranim nadzorom (Corbin et all, 2007) primjeni dovoljno kretne aktivnosti koja će uzrokovati određene pozitivne uticaje. Primjenom različitih već opisanih i primjenjivanih metodičko organizacijskih oblika rada (Hadžikadunić, Mađarević, 2004.), naročito onih koji omogućavaju povećanje intenziteta aktivnosti na satu nastave sporta i tjelesnog odgoja, može se doprinjeti unaprijeđenju transformacije antropološkog statusa u toku nastave (Wallhead et al., 2013). Da bi provjerili postoji li razlika u kretanju na času sporta i tjelesnog odgoja između muške i ženske populacije studenata, te kako bi se nastavnici upoznali sa ovom činjenicom, realizovano je i ovo istraživanje. Dakle, u ovom istraživanju postavljeni cilj bio je utvrđivanje razlike u aktivnosti na času nastave sporta i tjelesnog odgoja, praćenjem broj načinjenih koraka muške i ženske populacije. Na osnovu načinjenog broja koraka izračunat je pređeni put i za jednu i za drugu populaciju. Broj koraka registrovan je primjenom pedometara tokom provedenih aktivnosti (Schofield et al., 2005.) a za muškarce i djevojke određena je ista dužina koraka.

METODE RADA

Uzorak ispitanika

Uzorak ispitanika činili su studenti Fakulteta sporta i tjelesnog odgoja Univerziteta u Sarajevu. Ukupno je praćeno 57 studenata, od toga 29 ispitanika muškog i 28 ispitanica ženskog spola. Studenti su polaznici treće godine studija na Fakultetu – I ciklus. Selekcionisani su u prvoj godini kriterijumima za upis na Fakultet sporta i tjelesnog odgoja. Starost ispitanika kretala se u rasponu 21 – 22 godine života i za mušku i za žensku populaciju. Svi studenti su iz Bosne i Hercegovine i nisu aktivni sportisti.

Uzorak varijabli

Varijable tretirane u ovom radu, a za koje se smatra da su odgovarajuće za ostvarenje cilja istraživanja jesu: Broj načinjenih koraka, Pređena dužina puta izražena u metrima, Visina i Težina ispitanika.

Metode prikupljanja podataka

Broj koraka praćen je primjenom pedometara Yamax DIGI – WALKER koji je bio zakačen za pojas svakog testiranog studenta (Tudor-Locke et al. 2006). Pređena dužina puta se izračunavala pretvaranjem dužine koraka u pređenu distancu tako daje svaki načinjeni korak pomnožen sa 65 cm (Sternfeld i Goldman-Rosas, 2012.). Druge varijable korištene u istraživanju su Visina i Težina - izmjereni na klasičan način upotrebom vage sa visinomjerom (digitalna TANI-TA vaga WB-3000 sa maksimalnom mjernom težinom do 200 kg i mehaničkim visinomjerom od 64 cm do 214 cm). Veličina sale u kojoj je realizovan nastavni sadržaj je 40 m x 20 m. Temperatura u sali bila je kontinuirano 21 stepen celzijusa, a metodičko organizacijski oblik rada koji je primjenjen jeste „jednostazni poligon¹“. U zavisnosti od dijela nastavnog sata primjenjivani su različiti poligoni kako nebi tokom nastavnog sta došlo do zasićenja ili dosade polaznika (Hrnjelovec et al 2005). Nastavni čas bio je organizovan u klasičnom trajanju od 45 minuta, a postavljeni poligoni korišteni su u uvodnom, glavnom i završnom dijelu časa, dok su u pripremnom dijelu časa primjenjene vježbe „oblikovanja“ (Findak, 2001).

Analiza podataka

U prvoj fazi analize podataka primjenjene su deskriptivno statističke metode koje nam mogu pomoći da generalizujemo podatke. U drugoj fazi izvršeno je utvrđivanje razlika između tretiranih varijabli primjenom ANOVA analize. Korišteni programi za dobijanje odgovarajućih podataka su „Statistica 6“ i „SPSS 15.“ Podešeni nivo signifikantnosti za ANOVA analizu bio je na nivou $p \leq 0.05$.

REZULTATI ISTRAŽIVANJA

Deskriptivno statistički pokazatelji za 29 muških ispitanika i 28 ženskih ispitanica (Tabela 1) pokazali su da je prosječna visina muške populacije 186,3 cm i da je taj prosjek viši od prosjeka ženske populacije koji je na nivou 167,8

¹ Described by Hadžikadunić and Mađarević, 2004, reference navedene u poglavlju literatura

cm. Studenti su takođe teži od studentica ($M = 79,85$ kg i $\bar{Z} = 58,70$ kg). Dobjene karakteristike su u skladu sa uobičajenim karakteristikama za mušku i žensku populaciju u Bosni i Hercegovini (Rašidagić, Manić and Vidović, 2011), (Rašidagić, Baždarević and Mašala, 2012). Prosječan broj načinjenih koraka, kao i pređena dužina puta su takođe na strani muške populacije. Tokom časa, gledajući deskriptivne pokazatelje možemo konstatovati da su studenti napravili u prosjeku po 2577,03 koraka što je više nego što su to načinile studentice čiji je prosjek bio 1691,17 koraka. Možemo zaključiti da su studenti prosječno napravili 34,37% više koraka od studentica.

Tabela 1. Bazične karakteristike uzorka /Muškarci i Djevojke/

Karakteristike	Muškarci			Djevojke		
	BT	PV	SD	BT	PV	SD
Visina	29	183,6	5,88	28	167,8	8,44
Težina	29	79,85	8,48	28	58,70	7,77
Broj koraka	29	2557	661,0	28	1691	568,9
Dužina u metrima	29	1663,0	427,6	28	1099,5	369,8

BT – Broj testiranih, Prosjek – Prosječna vrijednost, SD - Standardna devijacija

Primjena ANOVA analize (Tabela 2.) za visinu i težinu nije potvrdila statističku značajnost evidentirane razlike iako u Tabeli 1. postoji razlika u prosječnim vrijednostima. Pretpostavlja se da je na izostanak značajnosti razlike uticalo nekoliko ekstremnih rezultata u visini i težini izmjerenih populacija. Na osnovu ovakvih pokazatelja koji nisu pokazali statističku značajnost u visini i težini istraživanih populacija određena je jedinstvena dužina koraka za obje populacije na 65 cm. Sternfeld i Goldman-Rosas (2012) su na sličan način posmatrali ponašanje ispitanika u njihovom istraživanju, odnosno nisu pravili razlike u dužini koraka, a pedometrom Yamax DIGI – WALKER je takođe predviđena jedinstvena prosječna dužina koraka (mjerena od "pete do pete") na 65 cm.

Diskusija

Postavljeni cilj u istraživanju bio je utvrđivanje razlike u aktivnosti na času nastave sporta i tjelesnog odgoja, praćenjem broja načinjenih koraka muške

i ženske populacije. Kao pokazatelj aktivnosti na satu korištena je varijabla napravljeni broj koraka na satu koja se registrovala postavljanjem pedometra za pojas ispitanika. Na sličan način su Corder et. al. (2008.), Zhu (2008) i Melanson et al. (2004) prikupljali podatke ispitanika i tako dobijali određene pokazatelje o kretanju. U ovom istraživanju djevojke su načinile u prosjeku 34,37% manje koraka od muškaraca. Kada je broj koraka pretvoren u pređenu dužinu puta (napominjemo da je ista dužina koraka od 65 cm određena i za mušku i za žensku populaciju obzirom da nema statistički značajne razlike u visini što je jedan od pokazatelja ANOVA analize iz Tabele 2.) izračunato je da su u prosjeku studenti načinili značajno veći broj koraka i preračunato u metre prešli 1663 metra. Za studentice preračunati pređeni put izračunat je na 1099,5 metara, odnosno pređena je "manja dužina puta". Dobijeni pokazatelj je takođe u skladu sa istraživanjima koje je proveo Mc Kenzie (2006) koji je utvrdio da je ženska populacija uopšteno gledajući manje aktivna od muške. Po izvršenoj provjeri ANOVA analizom potvrđeno je da je prisutna i statistička značajnost u pređenom putu na času nastave sporta i tjelesnog odgoja u korist studenata. Dakle u istim uslovima rada studentice su načinile manje koraka i prešle manji put, odnosno bile manje aktivne tijekom časa (Cohen et al. 2008). Dobijeni pokazatelji o manjoj aktivnosti na nastavi različiti su u odnosu na pokazatelje za slobodno provedeno vrijeme studenata u istraživanjima provedenim od strane Pillay et al. (2014.) gdje su pripadnice ženskog spola bile u slobodno vrijeme aktivnije od muške populacije. Obzirom da je cilj ovog istraživanja bio utvrđivanje razlike u aktivnosti na času sporta i tjelesnog odgoja koja se posmatrala na osnovu broja načinjenih koraka muške i ženske populacije studenata i da su ANOVA analizom utvrđene statistički značajne razlike u broju napravljenih koraka u korist studenata možemo konstatovati da je isti i ostvaren te da su studenti aktivniji od studentica (Tudor-Locke i drugi, 2008.). Tvrdnju pojačava i izračunata pređena dužina puta u metrima, gdje su studenti prešli statistički značajnu veću dužinu puta od studentica. Nakon potvrde značaja u razlici svi studenti (muškarci i djevojke) su upoznati s rezultatima provedenog istraživanja kao i rezultatima drugih istraživanja a koja govore o razlikama u kretanju (Zizzi, 2006.), nakon čega im je dopušteno da razmjene svoja mišljenja sa nastavnikom i drugim studentima (Bowles, 2012.). Nakon razgovora se konstatuje da kretanje koje ostvaruju studentice tokom časa tjelesne i zdravstvene kulture treba biti povećano, kao i da same studentice trebaju biti savjesne pri realizaciji zadataka tokom nastave tjelesnog odgoja koja podržava pozitivne promjene organizma (Dauenhauer i Keating 2011.) i (Marcus, Forsyth, 2003).

ZAKLJUČCI

Ovim istraživanjem dokazana je manja aktivnost studentica na času tjelesnog odgoja. Pokazan jedan od načina korištenje pedometra u cilju unaprijeđenja nastavnog procesa a kojim se može učinkovito kontrolirati aktivnost.

S ciljem povećanja aktivnosti kretanja studentica tokom nastave, predlaže se da nastavnici koriste dodatnu motivaciju tokom časa ali i da prethodno obave motivacijske razgovore sa studenticama u poticanju na aktivnost.

Što se tiče ograničenja primjene rezultata istraživanja možemo reći da je za očekivati da uzorak sa različitim karakteristikama u odnosu na testirane može dati nešto drugačije pokazatelje.

Tokom istraživanja nije analizirana vrsta kretanja ispitanika (da li su koraci napravljeni trčanjem ili hodanjem) te će autori u narednom periodu analizirati i ove aspekte kako bi dobili što preciznije pokazatelje o aktivnosti na času.

REFERENCE

Amstrong N, Welsman JR. The physical activity patterns of European youth with reference to methods of assessment. *Sports Medicine*, 2006; 36:1067-1086

Bowles HR. Measurement of Active and Sedentary Behaviours: Closing the Gaps in Self-Report Methods. *Journal of Physical Activity and Health*, 2012; 9 (Suppl 1), S1-S4.

Burgeson CR, Wechsler H, Brener ND, Young J C, Spain C G. Physical education and activity: Results from the school health policies and programs study 2000. *Journal of school health*, 2001; 71:279-293

Cale L, Harris J. School-based physical activity interventions: effectiveness, trends, issues, implications and recommendations for practice. *Journal of sport sciences*, 2006; 11: 401-420.

Cohen D, Scott M, Zhen-Wang F, McKenzie TL, Porter D. Design and Physical Activity Among Middle School Girls. *Physical Activity and Health*, 2008; 5: 719 – 731

Chan CB, Tudor-Locke C. Real-world evaluation of a community-based pedometer intervention. *Journal of Physical Activity and Health*, 2008; 5: 648-664

Corbin, C.B., Welk, G.J., Corbin, W.R., & Welk, K.A. (2007). *Fitness i wellness. Kondycja, sprawność, zdrowie*. Wydawnictwo: Zysk i s-ka.

Corder K, Ekelund U, Steele RM, Wareham NJ, Brage S. Assessment of physical activity in youth. *J Appl Physiol*. 2008;105(3):977–987.

Dauenhauer BD, Keating XD. The Influence of Physical Education on Physical Activity Levels of Urban Elementary Students. *Journal of sport sciences*, 2011; 82: 512-520.

Findak V. *Methodology of physical education*. Zagreb: School book, 44-51; 2001

Groffik D, Fröme K, Pelclová J. Pedometers as a Method for Modification of Physical Activity in Students. *Journal of Human Kinetics*, 2008; 20:131-137

Hmjelovjec I, Kalić E, Hmjelovjec D. *Gymnastic polygons as a tool for physical development*. Faculty of Sport and Physical Education, University of Sarajevo, 138-149; 2005

Hadžikadunić M, Mađarević M. *Methodology of teaching the physical education with the basics in exercise physiology*. Zenica: Pedagogical Faculty in Zenica, 249-281; 2004

Marcus B H, Forsyth L H. Motivating people to be physically active. Champaign, IL: Human Kinetics, 34-39; 2003

Mc Kenzie TL, Catellier DJ, Conway T, Lytle LA, Grieser M, Webber LA, Pratt CA, Elder JP. Girls' activity levels and lesson contexts in middle school PE: TAAG baseline. *Medicine and Science in Sports and Exercises*, 2006; 38: 1229-1235

Melanson EL, Knoll JR, Bell ML, Donahoo WT, Hill JO, Nysse LJ, et al. Commercially available pedometers: Considerations for accurate step counting. *Prev Med* 2004;39(2):361-68.

Mota J, Silva P, Paula-Santos M, Ribeiro J C, Oliveira J, Duarte J. *Physical activity and school recess time: Differences between the sexes and the relationship between children's playground physical activity and habitual physical activity*. *Journal of Sports Sciences*, 2005; 23: 269 – 275

Pillay DJ, Kolbe-Alexander TL, van Mechelen W, Lambert EV. Steps That Count: The Association Between the Number and Intensity of Steps Accumulated and Fitness and Health Measures. *Journal of Physical Activity and Health*, 2014; 11: 10-17

Rašidagić F, Manić G, Vidović N. *Influence of morphological characteristics on the success of the implementation of the contents of teaching sports and physical education*. Sarajevo: University book, University of Sarajevo, 83 – 85; 2012.

Rašidagić F, Baždarević A., Mašala, A. Latent structure of morphological characteristics of a student secondary school. *Journal Sports Logos*, Teaching Faculty, Department of Sports and Health, University of Džemal Bijedić in Mostar, 2012; 18/12: 28-34.

Schofield L, Mummery WK, Schifield G. Effects of a controlled pedometer-intervention trial for low-active adolescent girls. *Medicine and Science in Sports and Exercises*, 2005; 37:1414-1420

Sternfeld B, Goldman-Rosas L. A. Systematic Approach to Selecting an Appropriate Measure of Self-Reported Physical Activity or Sedentary Behaviour. *Journal of Physical Activity and Health*, 2012; 9:S19-S28

Tudor-Locke K, Lee SM, Morgan CF, Beighle A, Pangrazi R. Children's Pedometer-Determined during the Segmented School Day. *Medicine and Science in Sports and Exercises*. 2006; 10: 1732-1738

Tudor-Locke C, Bassett DR, Rutherford WJ, Ainsworth BE, Chan CB, Croteau KA, Giles-Corti B, Le Masurier G, Moraueu K, Mrozek J, Oppert JM, Raustorp A, Strath SJ, Thompson D, Whitt-Glover MC, Wilde B, Wojcik JR. BMI-Referenced Cut Points for Pedometer-Determined Steps per Day in Adults. *JPAH*, 2008; 5: 126-139.

Tudor-Locke C., Sisson, S., Lee, S., Craig, C. Plotnikoff, R. Bauman, A. *Evaluation of Quality of Commercial Pedometers*. Canadian Journal Of Public Health, 2006; VOL. 97, SUPP. 1, Pg. 12 – 15. Canada

Wallhead TL, Garn AC, Vidoni ED, Youngberg C. Game Play Participation of Amotivated Students During Sport Education. *JTPE-Academy of the National Association for Sports and Physical Education and International Association for Physical Education in Higher Education*, 2013; 32:149-165,

Zizzi S. Impact of a three-week pedometer intervention on high school students' daily step counts and perceptions of physical activity. *American Journal of Health Education*, 2006; 37:35-40

Zhu W. Promoting physical activity using technology. *Research Digest*, 2008. 9 (3), 1-8.

To body fat related anthropometry for female students with different physical activity attitudes

Dorjana Zerbo Šporin

Univeristy of Primorska, Koper, Slovenia

ABSTRACT

Obesity is a public health problem that has become epidemic worldwide. Physical activity is an important determinant of body size, inducing a healthier body composition. The purpose of the present study was to determine the link between the amount of physical activity and anthropometric parameters related to body fatness of female students. Anthropometry was carried out in 169 female students from various Faculties of the University of Ljubljana. 59 female students from Faculty of Sports (as athletes) were physically active during school process at least 11 hours per week more than others 110 students which belong to non-athletes. Differences in anthropometric parameters among athletes and non-athletes were tested by analysis of variance (ANOVA). Lower values for all measured anthropometrical parameters were associated with higher levels of physical activity among athletes, but significantly only for skinfolds ($p < 0.05$) with the exception for suprailiac skinfold. While significant difference for central body fat amount (represented by the waist circumference) between both groups of students wasn't noted. According to the observed we could suppose that the greater volume of weekly physical activity reflects in a smaller amount of subcutaneous, but not also visceral fat.

Key words: young adults, women, body fatness, athletes, non-athletes

INTRODUCTION

Lack of physical activity (PA) can lead to excessive body weight. Overweight and obesity are defined as excessive fat accumulation that presents are risk factor for a number of chronic illnesses, including diabetes type II, cardiovascular

diseases and some cancers (WHO, 2013). Obesity is a public health problem that has become epidemic worldwide (Chan & Woo, 2010). It is estimated that more than half of adults aged 35-65 living in Europe are either overweight or obese (Seidell & Flegal, 1997). Physical activity is an important determinant of body size, inducing a healthier body composition (Lohman et al., 2008). A higher level of PA reduces abdominal adiposity independent of baseline and changes in body weight and is thus a useful strategy for preventing chronic diseases and premature deaths (Ekelund et al., 2011). After endurance training programme also the reductions in skinfold thickness and circumferences occur what is more pronounced in the truncus area. This indicates a preferential loss of fat from the central regions of the body (Kohrt et al. 1991). The purpose of the present study was to determine the link between the amount of physical activity and anthropometric parameters related to body fatness of female students.

METHODS

Anthropometry was carried out in 169 female students from various Faculties of the University of Ljubljana. They came from all Slovenian regions, most of them from Central Slovenia. At the time of measuring they were in average 22 years old, corresponding to the early adult life period. The study was part of the doctoral thesis carried out at the Department of Biology, Biotechnical Faculty in Ljubljana. The research was performed in accordance with the ethical standards of the Declaration of Helsinki/Tokyo and the Code of Medical Deontology. All volunteers were fully informed of the procedures before written consents were obtained. Students were interviewed on the amount of their physical activity per week. 59 female students from Faculty of Sports (as athletes) were physically active during school process at least 11 hours per week more than others 110 students which belong to non-athletes (Table 1). In the present research the intensity physical activity was not evaluated.

All anthropometric measurements were taken in the morning by the same examiner in a quiet, properly illuminated and thermally neutral environment. The participants were wearing light indoor clothing. Body weight (BW), waist (WC) and hip (HC) circumference, skinfolds thicknesses at five sites were measured according the standardized International Biological Programme protocol (Weiner & Lourie, 1996). The BW was determined on Tanita TBF-305 (Tanita Corporation, Arlington Heights, IL), to 0.1 kg accurately. WC was

estimated halfway between the costal edge and iliac crest on the side and between processusxpyhoideus and umbilicus in front. HC was measured at the greatest circumference around the buttocks. Both circumferences were taken with a flexible inextensible tape and expressed accurately to 0.1 cm. Skinfolde thicknesses were specified using a John Bull' calliper with a constant pressure of 10 g/cm² and expressed in mm. Three consecutive measurements of each skinfold were taken in the following order and the average value was accepted: subscapular skinfold (SubScSk), suprailiacal skinfold (SuplISk), abdominal skinfold (AbdSk), triceps skinfold (TriSk) and calf skinfold (CSk). Before statistical analysis all variables were tested for normality with Kolmogorov-Smirnov test. Descriptive statistics, as mean () and standard deviation (SD, was determined. All data values are presented as M±SD. Differences in anthropometric parameters among athletes and non-athletes were tested by analysis of variance (ANOVA).

RESULTS

It is apparent from table 1 that athletes were physically active for at least 11 hours per week more than non-athletes. However, since the largest portion (81%) among non-athletes were physically active 1-4 hours per week and 64% of athletes for 16-18 hours per week, both groups in majority differ for 15 hours of weekly physical activity (Table 1).

Table 1: Hours of physical activity per week for athletes and non-athletes.

Athletes (N=59)				
Hours of physical activity per week during free time	1-4	5-7	8-10	>10
Hours of physical activity per week during school process	11	11	11	11
All hours of physical activity per week	12-15	16-18	19-21	>21
Number of participants in the group	12 (20%)	38 (64%)	6 (10%)	3 (6%)
Non-athletes (N=110)				
All hours of physical activity per week	1-4	5-7	8-10	>10
Number of participants in the group	89 (81%)	17(15.5%)	3 (2.7%)	1 (0.8%)

N = number of participants

Lower values for all measured anthropometrical parameters were associated with higher levels of physical activity among athletes, but

significantly only for skinfolds ($p < 0.05$) with the exception for suprailiac skinfold. The highest difference was found for calf skinfold, being in average 6.2 mm larger in non-athletes. While significant difference for central bodyfat amount (represented by the waist circumference) between both groups of students wasn't observed (Table 2).

Table 2: The analysis of variance for anthropometric parameters between athletes and non-athletes

Anthropometric parameter	Athletes (A)	Nonathletes (N)	$M_A - M_N$	F	p
	M±SD				
Bodyweight (kg)	59.9±5,5	60.6±9,7	-0.7	0.22	0.64
Waist circumference (cm)	69.0±3,6	69.5±6,6	-0.5	0.93	0.62
Hip circumference (cm)	96.2±4,7	97.9±7,3	-1.7	2.80	0.10
Subscapular skinfold (mm)	11.2±2.4	12.5±4.3	-1.3	4.82	0.03*
Suprailiacal skinfold (mm)	11.5±3.4	13.2±6.3	-1.7	3.37	0.07
Abdominal skinfold (mm)	15.9±4.8	18.4±7.1	-2.5	5.77	0.02*
Triceps skinfold (mm)	13.5±3.5	15.8±4.8	-2.3	10.89	0.00*
Calf skinfold (mm)	15.5±4.9	21.7±7.4	-6.2	33.03	0.00*

* $p < 0.05$

M±SD = mean ± standard deviation

F=relation between inter- and intra-sample variance

p =level of statistical significance for differences between groups

DISCUSSION AND CONCLUSIONS

Routine physical activity has been shown to improve body composition (e.g., through reduced abdominal adiposity and improved weight control) (Paffenbarger et al., 1986). In our research athletes have a lower body weight and abdominal circumference, however, the difference between athletes and non-athletes are not significant. All measured skinfolds are thinner within athletes, the only exception being for suprailiac skinfold. According to the observed we could suppose that the greater number of weekly hours of physical activity reflects in a smaller amount of subcutaneous, but not also visceral fat. Another possible explanation for this is that in the study we have deal with a narrow age group, namely young adult females which are characterized by a "gynoidal" fat distribution with greater hip circumference compared to the waist

circumference, indicated also by Zerbo – Šporin (2013). Sample of wider age range could be delivered different results regarding abdominal circumference of athletes and non-athletes. In their investigation, Štefančič & Tomazo – Ravnik (1992), also found out that comparing to non-athletes female athletes had significantly thinner skinfolds but similar anthropometric parameters that define overall and visceral obesity.

We conclude that a greater volume of weekly physical activity reflects among young adult females potentially maintains a lower amount of subcutaneous fat, which was not shown for waist circumference.

ACKNOWLEDGEMENTS AND DISCLOSURES

I thank my colleagues Marija Štefančič and Tatjana Tomazo-Ravnik for professional support. Thanks to all the participants in the study. Part of this work was with a completely different research goal presented by Dorjana Zerbo-Šporin and Marija Štefančič in *Physique and body composition*, Biennial of Books of EAA (2014) and by Dorjana Zerbo-Šporin in *Zdravstvenovarstvo* (2013); 52: 210-220.

REFERENCES

Chan Ruth, SM., & Woo, J. (2010). Prevention of Overweight and Obesity: How Effective is the Current Public Health Approach. *International Journal of Environmental Research and Public Health*, 7(3), 765-783.

Ekelund, U., Besson, H., Luan, J., May, A.M., Sharp, S.J., Brage, S. et al. (2011). Physical activity and gain in abdominal adiposity and body weight: prospective cohort study in 288,498 men and women. *American Journal of Clinical Nutrition*, 93, 826–835.

Kohrt, W.M., Obert, K.A., Holloszy J.O. (1991). Exercise training improves fat distribution patterns in 60- to 70-year-old men and women. *Oxford Journal of Medicine & Health*, 47 (4): 99-105.

Lohman T.G., Ring K., Pfeiffer K, Camhi S., Arredondo E., Pratt C., Pate R., Webber L.S. (2008). *Medicine & Science in Sports & Exercise*, 40(6), 1163–1170.

Paffenbarger, RS., Hyde, RT., Hsieh. CC. (1986). Physical activity, other life-style patterns, cardiovascular disease and longevity. *Acta Medica Scandinavica Suppl*, 711, 85-91.

Seidell, JC., & Flegal, KM. (1997). Assessing obesity: classification and epidemiology. *British Medical Bulletin*, 53(2), 238-252.

Štefančič, M., & Tomazo-Ravnik, T. (1992). Vpliv športne aktivnosti na nekatere morfološke karakteristike ljubljanskih študentov in sekularne razvojne tendence pri športnikih. *Biološki Vestnik*, 40(1), 27-34.

Weiner, J.S., & Lourie, J.A. (1996). *Human biology: a guide to field methods*. Oxford: Burgess and Son Press.

World Health Organisation. Obesity and overweight. Fact sheet N°311. March 2013. <http://www.who.int/topics/obesity/en/>.

Zerbošporin, D. (2013). Body fat distribution of female students related to physical activity and risk to morbidity due to abdominal obesity. *Zdravstveno varstvo*, 52, 210-220.

Razlike u funkcionalnim sposobnostima učenika prema stupnju uhranjenosti

Marko Badrić, Kristina Ravlić

Učiteljski fakultet, Sveučilište u Zagrebu, Hrvatska

ABSTRACT

The aim of this study was to determine differences in functional abilities between primary school pupils with regard to the irnutritional status. The study used a sample of 129 students of third and fourth grade of elementary school, of which 75 boys with an average age 10.04 ± 0.78 and 54 girls with an average age 9.91 ± 0.59 . The sample of variables in this study was composed of anthropometric measures; body height, body weight, triceps skinfold, subscapular skinfold, abdominal skinfold test, abdominal skinfold test and for checking of functional abilities running 3 minutes - F3. Based on the calculated body mass index (BMI), the subjects were divided into three groups according to the nutritional status: a normal body weight, overweight and obese. The significance of differences between subsamples formed according to the level of nutrition and functional abilities was tested by t-test for independent samples. The results show that a little more than 4% of girls are considered obese, which is less than the obese boys where the data range is around 9%. Also a smaller percentage of girls are overweight than boys. Looking at the examinees according to the level of nutrition shows that 30% of students of both genders is overweight and obese. The results show that in both subsamples students differ significantly in the level of functional abilities according to the level of nutrition and the students who are overweight or obese have a significantly lower results in functional abilities. Based on the results of this study it can be concluded that the boys and girls who are overweight or have obesity have less developed functional abilities.

Keywords: body mass index, students, primary education, obesity, functional abilities

UVOD

Djeca s višim indeksom tjelesne mase (ITM) postiže slabije rezultate u testovima za procjenu tjelesne kondicije jer je prekomjerna tjelesna težina ograničavajući čimbenik razvoja, kako u snazi tako i u aerobnim sposobnostima (Andersen i sur., 2007). Više vrijednosti aerobnog kapaciteta u djetinjstvu i adolescenciji snažno je povezan sa trenutačnom razinom zdravlja ali i sa velikom predikcijom u budućnosti (Ruizi sur., 2007, Ortega i sur., 2011). Dovoljno je zabrinjavajući podatak da je svako treće dijete u dobi od 2-19 godina prekomjerno teško ili pretilo (Ogden i sur., 2012). Rezultati nekih istraživanja pokazali su da su prekomjerno teški ispitanici lošiji u kardiorespiratornim testovima od mršavijih ispitanika, te je dokazana niska do umjereno visoka obrnuta korelacija između kardiorespiratornog fitnesa i debljine (Winsley i sur., 2006; Arai sur., 2007). Davidson i suradnici (2013) su u svom istraživanju dokazali da je povećanje tjelesne mase kod djece i adolescenata povezano s općim smanjenjem plućnog volumena, povećanjem respiratornih simptoma i smanjenim funkcionalnim statusom. Smanjena razina funkcionalnih sposobnosti u kombinaciji sa suviškom tjelesne mase i s time povezanim sedilačkim stilom života neovisni su čimbenici rizika za kardiovaskularne (Tokmakidis i Kasambalis, 2006). Prekomjerna tjelesna masa i pretilost ukazuju na nepovoljniji kondicijski profil, no pomak iz jedne razine stupnja uhranjenosti u drugi može biti popraćena značajnim poboljšanjima tjelesne spremnosti (Petrić, Cetinić, Novak, 2010).

Cilj ovog istraživanja je utvrditi razlike u funkcionalnim sposobnostima između učenika primarnog obrazovanja s obzirom na stupanj njihove uhranjenosti.

METODE

U istraživanju je korišten uzorak od 129 učenika trećih i četvrtih razreda osnovne škole, od čega 75 dječaka prosječne dobi $10,04 \pm 0,78$ godina i 54 djevojčice prosječne dobi $9,91 \pm 0,59$ godina. Uzorak ispitanika obuhvaćao je učenike Osnovne škole Dragutina Tadijanovića Petrinja i Prve Osnovne škole Petrinja. Svi učenici bili su potpuno zdravi u vrijeme provođenja istraživanja. Istraživanje je provedeno u skladu s Etičkim kodeksom istraživanja s djecom koji je pripremio Vijeće za djecu kao savjetodavno tijelo Vlade Republike Hrvatske. Za svakog ispitanika roditelji su dali pismeni pristanak za sudjelovanje u istraživanju. Uzorak varijabli u ovom istraživanju sastojao se antropometrijskih

mjera; tjelesna visina, tjelesna težina, kožni nabor nadlaktice, kožni nabor leđa, kožni nabor trbuha. Sve mjere provedene su prema InternacionalBiological Program (IBP - Weiner i Lourie, 1968).Visina tijela izmjerena je uz pomoć antropometra, a tjelesna masa uz pomoć digitalne vage. Kožni nabori izmjereni su LangeovimSkinfoldkaliperom. Funkcionalne sposobnosti provjeravane su testom trčanje 3 minute - F3, koji se koristi za procjenu razine funkcionalnih sposobnosti u primarnom obrazovanju u Republici Hrvatskoj (Findak i suradnici, 1996). Na temelju izračunatog indeksa tjelesne mase, putem tablica preporučenih od strane International ObesityTaskForce (Cole i sur., 2000), ispitanici su svrstani u tri skupine prema stupnju uhranjenosti: normalna tjelesna masa, prekomjerna tjelesna masa i pretili. Za procjenu postotka masti u organizmu korištena je suma kožnog nabora leđa i kožnog nabora nadlaktice prema Slaughterovoj jednadžbi (Slaughter i sur., 1998). Obrada podataka je obavljena programom STATISTICA (data analysis software system), version 7.1. Pri obradi podataka za sve istraživane varijable izračunati su osnovni deskriptivni parametri:aritmetička sredina, standardna devijacija te minimalan i maksimalan rezultat. Normalnost distribucije varijabli testirana je Kolmogorov-Smirnovljevim testom. Značajnost razlika između formiranih subuzoraka prema stupnju uhranjenosti i funkcionalnih sposobnosti testirana je t-testom za nezavisne uzorke. Statistička značajnost razlika testirana je na razini značajnosti $p < 0,05$.

REZULTATI

U slijedećim tablicama. prikazani su rezultati deskriptivnih parametara za dječake i djevojčice koji su obuhvaćeni istraživanjem

Tablica 1. Deskriptivni statistički parametri dječaci

	N	AS±SD	MIN	MAX	K-S test
Tjelesna visina	75	144,53±7,86	129,00	166,00	$p > .20$
Tjelesna težina	75	39,33±10,45	24,70	69,50	$p < ,15$
Indeks tjelesne mase	75	18,60±3,52	13,46	27,93	$p < ,10$
% Masti	75	23,92±8,27	9,29	43,61	$p > .20$
Trčanje 3 minute	75	543,40±118,35	180,00	840,00	$p > .20$

N= broj ispitanika; AS= aritmetička sredina; SD= standardna devijacija; MIN= minimalan rezultat; MAX= maksimalan rezultat; K-S test=Kolmogorov-Smirnovljevi test

Tablica 2. Deskriptivni statistički parametri djevojčice

	N	AS±SD	MIN	MAX	K-S test
Tjelesna visina	54	145,96±8,21	129,00	158,90	p > .20
Tjelesna težina	54	39,52±9,70	23,40	76,90	p > .20
Indeks tjelesne mase	54	18,39±3,35	13,95	30,80	p > .20
% Masti	54	26,30±8,37	16,77	58,76	p < .10
Trčanje 3 minute	54	522,98±80,25	300,00	665,00	p > .20

N= broj ispitanika; AS= aritmetička sredina; SD= standardna devijacija; MIN= minimalan rezultat; MAX= maksimalan rezultat; K-S test=Kolmogorov-Smirnovljev test

Gledajući rezultate u tablici 1.i 2. vidljivo je da su prosječne vrijednosti tjelesne visine dječaka niže nego kod djevojčica. Tjelesna težina je na istim razinama kod oba spola kao i vrijednosti indeksa tjelesne mase. Isto tako vidljivo je da dječaci imaju nešto niže vrijednosti postotka masti u organizmu (23,92%) od djevojčica (26,30%). Gledajući rezultate u varijabli trčanja na 3 minute, vidljivo je da su vrijednosti nešto više kod dječaka 543,40 metara u odnosu na djevojčice koje su postigle prosječni rezultat u ovom testu od 522,98 metara. Rezultati Kolmogorov - Smirnov testa pokazali su normalnost distribucije kod oba istraživana uzorka.

Tablica 3. Rezultati postotaka učenika prema stupnju uhranjenosti

	Normalna tjelesna masa	%	Prekomjerna tjelesna masa	%	Pretili	%
dječaci	50	67	16	21	9	12
djevojčice	40	74	10	19	4	7
UKUPNO	90	70	26	20	13	10

Gledajući rezultate u tablici 3. vidljivo je da je postotak dječaka (67%) koji su normalne tjelesne težine manji nego kod djevojčica (74%). Isto tako veći broj je prekomjerno teških ili pretilih dječaka u odnosu na djevojčice. Gledajući ukupan uzorak učenika vidljivo je da 30% učenika ima problem sa prekomjernom tjelesnom težinom i pretilosti.

Tablica 4. Rezultati t-test funkcionalnih sposobnosti dječaka prema stupnju uhranjenosti

	Normalna tjelesna masa N=50	Prekomjerna tjelesna masa N=16	Pretili N= 9	t-test	
				t-vrijednost	p-razina
	AS	AS	AS		
Trčanje 3 minute	589,72±96,06	473,75±92,73	/	4,24	0,00
Trčanje 3 minute	589,72±96,06	/	409,89±92,73	5,00	0,00
Trčanje 3 minute	/	473,75±92,73	409,89±92,73	1,50	0,15

Promatrajući tablicu 4. uočavaju se značajne razlike u rezultatima testa trčanja na 3 minute kod dječaka različitog stupnja uhranjenosti. Vidljivo je kako učenici normalne tjelesne mase imaju značajno bolje rezultate od učenika koji imaju prekomjernu tjelesnu masu ili su pretili. Značajne razlike nisu uočene između učenika prekomjerne tjelesne mase i pretilih učenika.

Tablica 5. Rezultati t-test funkcionalnih sposobnosti djevojčica prema stupnju uhranjenosti

	Normalna tjelesna masa N=40	Prekomjerna tjelesna masa N=10	Pretili N= 4	t-test	
				t-vrijednost	p-razina
	AS	AS	AS		
Trčanje 3 minute	545,68±63,79	472,40±80,00	/	3,09	0,00
Trčanje 3 minute	545,68±63,79	/	422,50±113,25	3,43	0,00
Trčanje 3 minute	/	472,40±80,00	422,50±113,25	0,94	0,36

Rezultati u tablici 5. prikazuju značajne razlike u rezultatima testa trčanja na 3 minute kod djevojčica različitog stupnja uhranjenosti. Djevojčice normalne tjelesne mase imaju značajno više rezultate u testu za procjenu funkcionalnih sposobnosti. Također, vidljivo je da pretile djevojčice imaju niže rezultate, ali u odnosu na djevojčice sa prekomjerno tjelesnom masu razlike ipak nisu značajne.

RASPRAVA

Cilj istraživanja bio je utvrditi razlike u funkcionalnim sposobnostima između učenika normalne tjelesne težine u odnosu na učenike koji imaju prekomjernu tjelesnu težinu ili su pretili. Vrijednosti su pokazale da se oko 4%

djevojčica smatra pretilima, što je manje u odnosu na pretile dječake gdje se podaci kreću oko 9%. Isto tako manji je postotak djevojčica sa prekomjernom tjelesnom težinom u odnosu na dječake. Gledajući ispitanike prema stupnju uhranjenosti vidljivo je da je 30 % učenika oba spola prekomjerno teško i pretilo. Slični rezultati dobiveni su u istraživanju (Lazzeri i sur., 2008). Rezultati istraživanja Ostojića i suradnika (2011) pokazalo je veći broj učenika koji su prekomjerne tjelesne težine ili su pretili. Također, niži rezultati dobiveni su u istraživanju (Milanese i sur., 2010., Mamalakis i sur., 2000). U odnosu na istraživanje (Findak i sur., 1996.), istraživani učenici imaju nešto veće prosječne rezultate trčanja na tri minute. U odnosu na rezultate (Katić i sur., 2004.) gdje su i dječaci i djevojčice postigli su slabije rezultate u ovom testu za procjenu aerobnih sposobnosti. Dobiveni rezultati pokazuju da se kod oba subuzorka učenici značajno razlikuju u razini funkcionalnih sposobnosti prema stupnju uhranjenosti te da učenici koji imaju prekomjernu tjelesnu težinu ili su pretili imaju značajno slabije rezultate u funkcionalnim sposobnostima (Mamalakis i sur., 2000, Vidaković Samaržija i sur., 2011)

ZAKLJUČAK

Kod učenika koji su pretili, vidljivo je da su im slabije razvijene funkcionalne sposobnosti. Dobiveni rezultati ukazuju da je utjecaj tjelesne mase izuzetno visok na rezultat u funkcionalnim sposobnostima. Kontinuirano svakodnevno tjelesno vježbanje doprinosi napretku funkcionalnih sposobnosti kod učenika, posebice u mlađoj dobi.

LITERATURA

Andersen, L. B., Froberg, K., Kristensen, P. L., & Moller, N. C. (2007). *Physical activity and physical fitness in relation to cardiovascular disease in children*. In W. D. Brettschneider & R. Naul (Eds.), *Obesity in Europe: young people's physical activity and sedentary lifestyles* (pp. 57–100). Frankfurt am Main: Peter Lang.

Ara, I., Moreno, L.A., Leiva, M.T., Gutin, B., Casajus, A. (2007). *Adiposity, physical activity, and physical fitness among children from Aragon, Spain*. *Obesity*; 15: 1918-1924

Cole, T.J., Bellizzi, M.C., Flegal, K.M., & Dietz, W.H. (2000). *Establishing a standard definition for child overweight and obesity worldwide: International survey*. *British Medical Journal*, 320, 1–6.

Davidson, W.J., Mackenzie-Rife, K.A., Witmans, M.B., Montgomery, M.D., Ball, G.D., Egbogah, S., Eves, N.D. (2013). Obesity negatively impacts lung function in children and adolescents. *Pediatr Pulmonol*; 49 (10): 1003-1010

Findak V, Metikoš D, Mraković M, Neljak B. (1996) Primjenjena kineziologija u školstvu – Norme. Hrvatski pedagoški-književni zbor. Zagreb. Fakultet za fizičku kulturu Sveučilišta u Zagrebu

Katić R, Pejčić A, Babin J. (2004) Integration of aerobic power into the morphological-motor system in children aged 7-11 years. *Coll Antropol*. 28:357-66.

Lazzeri, G., Rossi, S., Pammolli, A., Pilato, V., Pozzi, T., Giacchi, MV. (2008) Underweight and overweight among children and adolescents in Tuscany (Italy). Prevalence and short-term trends. *J Prev Med Hyg*. Mar;49(1):13-21.

Mamalakis G, Kafatos A, Manios Y, Anagnostopoulou T, Apostolaki I. Obesity indices in a cohort of primary school children in Crete: a six year prospective study. *Int. J. Obes. Relat. Metab. Disord*. 2000; **24**, 765-771

Milanese, C., Bortolami, O., Bertuccio, M., Verlato, G., Zancanaro, C. (2010). Anthropometry And Motor Fitness In Children Aged 6-12 Years, *Journal of Human Sport & Exercise*, Vol V No II, 265-279

Ogden, C.L., Carroll, M.D., Kit, B.K., Flegal, K.M. (2012). Prevalence of obesity and trends in body mass index among US children and adolescents, 1999-2010. *Journal of the American Medical Association*; 307 (5): 483-490

Ortega FB, Artero EG, Ruiz JR, Espana-Romero V, Jimenez-Pavon D, Vicente-Rodriguez G et al. (2011) Physical fitness levels among European adolescents: the HELENA study. *Br J Sports Med*; 45: 20-29.

Ostojic, S.M., Stojanovic, M.D., Stojanovic, V., Maric, J., & Njaradi, N. (2011). Correlation between fitness and fatness in 6-14-year-old Serbian school children. *Journal of Health, Population and Nutrition*, 29, 53-60

Petrić, V., Cetinić, J., Novak, D. (2010) Razlike u funkcionalnim sposobnostima između učenika iz urbane i ruralne sredine, *Hrvat. Športsko-med. Vjesn.*; 25: 117-121

Ruiz, J.R., Ortega, F.B., Loit, H.M., Veidebaum, T., & Sjöström, M. (2007). Body fatness associated with blood pressure in school-aged girls with low cardiorespiratory fitness: the European Youth Heart Study. *Journal of Hypertension*, 25, 2027-2034.

Slaughter MH, Lohman TG, Boileau RA, Horswill CA, Stillman RJ, van Loan MD, et al. (1998). Skinfold equations for estimation of body fatness in children and youth. *Hum Biol.*;60:709–23

Tokmakidis SP, Kasambalis A. (2006) Fitness level of Greek primary school children in relationship to overweight and obesity. *Eur J Pediatr*, 165:867-874.

Vidaković Samaržija, D., Pavelić Karamatić, L., Samaržija D. (2011). Utjecaj morfoloških karakteristika na motoričke i funkcionalne sposobnosti učenica. U Findak V. (ur.) Zbornik radova 20. Ljetne škole kineziologa Republike Hrvatske, „Dijagnostika u područjima edukacije, sporta, sportske rekreacije i kineziterapije“ Poreč., str.263- 269

Winsley, J.R., Armstrong, N., Midlebrooke, R.A., Ramos-Ibanez, N., Williams, C.A. (2006). Aerobic fitness and visceral adiposity tissue in children. *Acta Paediatr*; 95: 1435-1438

Efekti 24-satnog programa obuke neplivača na učenje osnovnih elemenata u plivanju

Edin Mirvić¹, Faris Rašidagić¹, Alma Dizdar²

¹*Faculty of Sports and Physical Education, University of Sarajevo, Bosnia and Herzegovina*

²*Olympic swimming pool Sarajevo, Bosnia and Herzegovina*

ABSTRACT

The main objective of this study was to determine the effects of 24-hour training program for non-swimmers on learning the basic elements of swimming in elementary school boys. The sample for this study consisted of 65 boys aged 8-10 years who attend school swimming "Olympic pool" in Sarajevo. At the univariate level for determining the partial quantitative differences in two time points (initial and final state) T-test for paired samples was applied. Overall, it can be concluded that in the initial state all were non-swimmers, and in the final all the students were adapted to the water and around 50% learned how to swim. It is evident that the elementary school swimming program that was situational scope had a positive impact on the transformation of the variable of swimming efficiency.

Keywords: students, elementary swimming school, T-test

UVOD

Plivanje (eng. swimming, franc. natation, njem. schwimmen...) je sposobnost da se tijelo održi na vodi i sposobnost da se kreće kroz vodu uz adekvatne pokrete rada ruku, nogu i tijela (Madić. i sar., 2007). U prilog tome koliko plivanje pozitivno utiče na zdravlje najbolje govori primjer Amerikanca John Weissmuller koji je bolovao od dječije paralyze. Ovom aktivnošću uspio se izliječiti i postati tadašnji svjetski rekorder i prvi čovjek koji je preplivao 100 m ispod jedne minute. Sa sigurnošću se može reći da plivanje ima

veliki i nezamjenljiv značaj u razvoju djeteta koji se očituje u morfološkom, funkcionalnom, psihološkom, biomotoričkom i intelektualnom razvoju mladog organizma. Tošić, (2009). Ovom vrstom aktivnosti u vodi razvija se smjelost, odvažnost, otpornost i ustrajnost, tj. osnovne pretpostavke neophodne za samostalan život. Rađo, (1998), u svom istraživanju dolazi do zaključka da: „Funkciji uspješnosti u plivanju najviše doprinose varijabele koordinacije, eksplozivne i repetativne sange, brzine i fleksibilnosti kao i brzine nervno-mišićne reakcije na vid“. Ovim sportom se mogu ostvariti značajni preventivno-korekcijski i terapijski uticaji na organizam djeteta. Topuzov, (1999). Djeca imaju slabiju muskulaturu tijela. Njihov organizam je podložan raznim deformacijama kičme zbog lošeg držanja i položaja tijela. Prilikom vježbanja u vodi djeca mogu izvoditi pokrete ravnomjerno i bez velikih napora na kičmeni stub. Na taj način efikasno opterećuju i jačaju muskulaturu trupa, a naročito mišiće leđa, grudi i ramenog pojasa, što doprinosi pravilnom držanju tijela. Obuka neplivača je jedan od temeljnih segmenata obuke sportskih tehnika plivanja. Cilj obuke neplivača je pripremiti polaznika za samostalan i siguran boravak u vodi, kao i usvajanje motoričkih navika kako bi se u vodi osjećali prijatno i sigurno. (Grčić-Zubčević, N., i sar., 2002.). Na temelju dvije grupe (8-10 god.) polaznika učenja plivanja koji su dolazili dva ili tri puta sedmično prognozir se potreban broj sati. Rezultati u prognozi broja sati potrebnih da bi najmanje 50% neplivača u programu od 12 nastavnih sati preplivalo 25 metara govore kako je potrebno 15 sati za nastavu koja se izvodi tri puta sedmično i 16 sati za nastavu koja se izvodi dva puta sedmično. Da bi uspio angažovati svoje stvaralačke sposobnosti instruktor se mora osloboditi različitih formalno tehničkih ograničenja (npr. slijepo pridržavanje plana i programa i pored izmijenjenih uslova rada, organizacija sata i vježbanje po propisanom šablonu, itd.). Prije samog izvođenja nastave potrebno je donijeti čitav niz odluka i uraditi pripremu, a opet, čest je slučaj da se usljed različitih problema predviđene odluke ne mogu realizovati, pa se instruktor mora postaviti fleksibilno. Savremeni fleksibilniji pristup zahtijeva da se u rad prelazi postepeno i neprimjetno kroz razgovor ili obraćanje polaznicima (npr. kako su, jesu li spremni za rad itd.) jer je to način animiranja. Dalje, u nastavi, znanja i postupci instruktora se usmjeravaju tako da uvijek dobija očekivani odgovor od polaznika. Pri ovome značajno je odabrati pravi način komunikacije koji zavisi od stava instruktora. Čas mora počinjati na vrijeme, a značajno je plasirati stimulanse učenicima koji moraju pokazati interes za rad. Organizacija (Hadžikadunić, Mađarević, 2004.) glavnog dijela časa se može provoditi kroz sljedeće oblike: frontalni

oblik koji je i najstariji oblik rada, grupni oblik rada i individualni oblik rada. Obzirom da je instruktor polaznicima primjer ponašanja, realno je očekivati da njihov pristup nastavi bude sličan učiteljevom. Torlaković, A., (2009). u svom je istraživanju dokazao da program obuke u trajanju od 12 sati ima efikasnost na polaznike elementarne škole plivanja. Radi se u heterogenim grupama. Obzirom da se u istoj grupi nalaze i ispitanici izrazito dobrih i ispitanici izrazito loših plivačkih sposobnosti, nastavnik je prisiljen primjenjivati sadržaje rada koji su s obzirom na volumen opterećenja – prosječni (Zenić, Grčić-Zubčević, 2005). Krajnji efekti u obuci plivanja ne ovise samo o njenoj organizaciji, već i od spremnosti učenja plivanja. Zadatak je da se u što većoj mjeri približi proces učenja plivanja svakom pojedinom učesniku. To se ne odnosi samo na svrstavanje u homogenizirane grupe, nego i na primjenu optimalnih metoda rada tokom učenja plivanja. Vlada mišljenje da će uspjeh u provođenju obuke plivanja ovisiti više o metodičkoj osposobljenosti učitelja plivanja, nego o drugim uslovima. (Findak, V. i I. Prskalo, 2004). Babin, B. (2012.) preporučuje da se radi i primjenjuje individualni oblik rada. Osnovni cilj istraživanja bio je da se utvrde efekti 24-satnog programa obuke neplivača na učenje osnovnih elemenata u plivanju učenika osnovne škole.

METODE ISTRAŽIVANJA

Uzorak ispitanika

Uzorak ispitanika za ovo istraživanje sačinjavali su dječaci uzrasta 8-10 godina koji pohađaju školu plivanja „Olimpijski bazen“ u Sarajevu. Broj ispitanika na kojima je izvršena konačna obrada i analiza podataka je 65 i svi su muškog pola. Svaki ispitanik je posebno testiran i rezultati su unešeni u njihove kartone.

Uzorak varijabli

Svaki ispitanik je pojedinačno testiran i rezultati testiranja unešeni su u njihove kartone. Procjena

znanja plivanja izvršena je prema sljedećim kriterijima:

Kriteriji za provjeru znanja plivanja su sljedeći:

1. Smije ući u vodu (SUV) - može / ne može ući u vodu,
2. Smije pokvasiti glavu (SPG) - može / ne može zaroniti glavu u plitku vodu,

3. Smije čučnuti pod vodu (SČV) – može / ne može čučnuti pod vodu,
4. Disanje u vodi (DUV) - može / ne može disati u vodi,
5. Pluta na plućima (PNP) - može / ne može plutati 5 sekundi,
6. Pluta na leđima (PNL) - može / ne može plutati 5 sekundi,
7. Klizi na plućima (KNP) – može / ne može da klizi na plućima minimalno 3m,
8. Klizi na leđima (KNL) – može / ne može da klizi na leđima minimalno 3m,
9. Skočiti na noge u plitku vodu (SNP) – skočio/nije skočio na noge u vodu od 150 cm
10. Skočiti na noge u duboku vodu (SND) - skočio/nije skočio u duboku vodu od 250 cm dubine.

Procjena plivačke efikasnosti inicijalnog i finalnog znanja plivanja izvršena je brojačno, ocjenom od 1 do 5 (Grčić-Zupčević, 1996):

1. Neplivač (1) = 0 – 12 metara. Učenik ne želi da dođe do vode ili dolazi do vode ali ne želi da uđe u vodu. Ako to uradi onda u vodu ulazi na nagon ili uz pomoć učitelja, pružajući mu ruke. Nakon ulaska u vodu pokušava samostalno hodati u vodi. Samostalno ulazi u vodu, hoda, trči, sjedi i ustaje iz vode. Pokušava da se održi na vodi u vodoravnom položaju plutanjem ili ronjenjem. Pokušava da se kreće po vodi u vodoravnom položaju radom nogu i ruku ili samo radom nogu. Nakon skoka prepliva bilo kojom tehnikom do 12 metara.

2. Plutač (2) = 12,5 – 24 metara. Nakon skoka učenik prepliva bilo kojom tehnikom 24 metra tj. manje od 25 metara.

3. Poluplivač (3) = 24 – 33 metara. Učenik prepliva bilo kojom tehnikom do 33 metra.

4. Plivač početnik (4) = 33 – 49 metara. Učenik poslije skoka prepliva bilo kojom tehnikom do 49 metara, tj. manje od 50 metara.

5. Plivač (5) = 50 i više metara. Učenik, nakon skoka, prepliva bilo kojom tehnikom 50 i više metara.

Program obuke

Program obuke elementarne škole plivanja trajao je ukupno 24 sata podijeljenih na 12 dana. Proveden je na Olimpijskom bazenu Otoka, sat i po dnevno u popodnevrim satima. Temperatura vode je bila između 26 i 28 °C. Realizatori programa su bili profesori sporta i tjelesnog odgoja. Svi ispitanici su bili testirani i imali iste uslove. Na početku istraživanja utvrđivano je inicijalno

stanje, a u toku istraživanja transverzalno i na kraju je izvršeno finalno testiranje ispitanika. Poslije utvrđivanja inicijalnog stanja napravljene su homogene grupe po 5 - 7 učenika i u toku istraživanja su se formirale nove grupe zavisno od napredovanja učenika. Za procjenu elementarnog plivanja u inicijalnom i finalnom stanju korištena je slijedeća terminologija: smije ući u vodu, smije pokvasiti glavu, smije čučnuti pod vodu, disanje u vodi, pluta na plućima, pluta na leđima, klizi na plućima, klizi na leđima...Instruktor je davao ocjene i formirao grupe po standardu: neplivač (1), plutač (2), poluplivač (3), plivač početnik (4), plivač (5).

Tabela br.1 Program elementarne škole plivanja – neplivača

Sadržaj dana (24 časa)	1	2	3	4	5	6	7	8	9	10	11	12
Provjera inicijalnog stanja	+											
Igre i vježbe navikavanja na vodu	+	+										
Igre i vježbe disanja	+	+	+	+	+	+	+	+	+	+	+	
Igre i vježbe gnju-ranja i gledanja		+	+									
Plutanje				+	+	+						
Klizanje u vodi					+	+	+	+	+	+	+	
Elementi skokova (na glavu – na noge)				+	+	+	+	+				
Tehnika kraul – ruke, noge, koordinacija				+	+	+	+	+	+	+	+	
Tehnika leđno – noge, ruke, koordinacija				+	+	+		+	+	+	+	
Provjera tranzitnog stanja		+		+	+	+		+	+	+	+	
Provjera finalnog stanja												+

METODE OBRADJE PODATAKA

Obrada dobivenih podataka vršena je u programskom paketu SPSS 22.0 for Windows. Na univarijantnom nivou za utvrđivanje parcijalnih kvantitativnih razlika kroz dvije vremenske tačke (inicijalno i finalno stanje) primijenjen je T-test za zavisne uzorke.

REZULTATI

U tabeli br.2 zastupljene su varijable (SUV i SPG) - smije ući u vodu i smije potopiti glavu. Dobijeni rezultati govore da nije došlo do statistički značajne razlike pod uticajem programa. Utvrđene su značajne promjene između inicijalnog i finalnog testiranja u testovima smije čučnuti pod vodu (SCV - SCVF) $p=,020$. Prosječno smanjenje vrijednosti u ovom testu bilo je ,224, dok se interval 95 - procentne pouzdanosti proteže od ,036 do ,412.

Značajne promjene između inicijalnog i finalnog testiranja imamo i u testovima disanja u vodi (DUV - DUVF) $p=,000$. Prosječno smanjenje vrijednosti u ovom testu bilo je ,530, dok se interval 95 - procentne pouzdanosti proteže od ,374 do ,686.

Značajne razlike između inicijalnog i finalnog testiranja imamo i u testovima pluta na plućima (PNP - PNOF) $p=,001$. Prosječno povećanje vrijednosti u ovom testu bilo je ,326, dok se interval 95 - procentne pouzdanosti proteže od ,146 do ,506.

Također, značajne razlike između inicijalnog i finalnog testiranja u testovima skočiti, pluta na leđima (PNL - PNLF) $p=,000$. Prosječno povećanje vrijednosti u ovom testu bilo je ,591, dok se interval 95 - procentne pouzdanosti proteže od ,437 do ,746. Značajne promjene između inicijalnog i finalnog testiranja u testovima klizi na plućima (KNP - KNPF) $p=,000$. Prosječno smanjenje vrijednosti u ovom testu bio je ,428, dok se interval 95 - procentne pouzdanosti proteže od ,243 do ,613.

Razlike između inicijalnog i finalnog testiranja su također statistički značajne u testovima klizi na leđima (KNL - KNLF) $p=,000$. Prosječno smanjenje vrijednosti u ovom testu bilo je ,571, dok se interval 95 - procentne pouzdanosti proteže od ,427 do ,715. Značajne razlike između inicijalnog i finalnog testiranja u testovima skočiti na noge u plitku vodu (SNP - SNPF) $p=,002$. Prosječno povećanje vrijednosti u ovom testu bio je ,285, dok se interval 95-procentne pouzdanosti proteže od ,109 do ,461.

Također, značajne razlike između inicijalnog i finalnog testiranja u testovima skočiti na noge u duboku vodu (SND - SNDF) $p=,000$. Prosječno povećanje vrijednosti u ovom testu bio je ,469, dok se interval 95-procentne pouzdanosti proteže od ,324 do ,614.

Značajne razlike između inicijalnog i finalnog testiranja su evidentne i u testovima inicijalnog i finalnog mjerenja (INC_M – FIN_M) $p=,000$. Prosječno povećanje vrijednosti u ovom testu bilo je -28,469, dok se interval 95 - procentne pouzdanosti kretao od -31,881 do -25,057.

Tabela br.2 Rezultati T-testa varijabli kriterija znanja plivanja i plivačke efikasnosti inicijalnog i finalnog stanja

Mean		Paired Differences					t	df	Sig. (2-tailed)
		Std. Deviation	Std. Error Mean	95% Confidence Interval of the Difference					
				Lower	Upper				
Pair 1	SUV - SUVF	,061	,555	,079	-,098	,220	,771	48	,444
Pair 2	SPG - SPGF	,102	,620	,088	-,076	,280	1,151	48	,255
Pair 3	SČV - SČVF	,224	,654	,093	,036	,412	2,403	48	,020
Pair 4	DUV - DUVF	,530	,543	,077	,374	,686	6,828	48	,000
Pair 5	PNP - PNPF	,326	,625	,089	,146	,506	3,655	48	,001
Pair 6	PNL - PNLF	,591	,536	,076	,437	,746	7,716	48	,000
Pair 7	KNP - KNPF	,428	,645	,092	,243	,613	4,648	48	,000
Pair 8	KNL - KNLF	,571	,500	,071	,427	,715	8,000	48	,000
Pair 9	SNP - SNPF	,285	,612	,087	,109	,461	3,266	48	,002
Pair 10	SND - SNDF	,469	,504	,072	,324	,614	6,516	48	,000
Pair 11	INC_M FIN_M	-28,469	11,878	1,696	-31,881	-25,057	-16,778	48	,000

DISKUSIJA

U nekim prethodnim istraživanjima zaključeno je da je elementarna škola plivanja od 12 sati nedovoljna, ali efikasan i dobar instruktor može ostvariti svoj cilj i naučiti djecu plivati koristeći svoje znanje, stručnost i iskustvo (Atha, J., A.D. Kinnear, i J.S. Sawbridge 1982). Ova konstatacija se čini i realnom jer se može odvojiti više vremena za ponavljanje i ispravljanje pojedinih grešaka i usvajanja znanja kod polaznika osnovne/elementarne škole plivanja. Preporučuje se veći fond sati elementarne/osnovne škole plivanja, a optimalno

24 sata. Tokom učenja djeca doživljavaju uspjehe u različitim situacijama i na različitim zadacima što kod njih izaziva osjećaj zadovoljstva, podstiče ih da istraju i postignu što bolji uspjeh u elementarnoj školi plivanja (Shapiro, Yun, & Ulrich, 2002). Torlaković, A., (2009), u svom istraživanju je pokazao da dječaci koji već treniraju neki od navedenih sportova efikasnije usvajaju osnovne elemente plivanja, u odnosu na djecu koja se ne bave ili se nikako ranije nisu bavili sportom. U ovom istraživanju učenici nisu bili aktivni sportisti i pokazala su nešto slabije rezultate. Svaki uspjeh i napredovanje kod mlađe populacije postiže se kroz igru. Na osnovu transverzalnog presjeka uočeno je da je ocjenu 1 je dobilo 47 učenika, što iznosi 95,92%. Na osnovu ovog pokazatelja možemo konstatovati da se prvih pet časova učenici adaptiraju na vodu i savladavaju osnovne elemente plivanja kao što su: smije potopiti glavu, smije čučnuti pod vodu, diše u vodi, pluta na plućima, pluta na leđima... Na sedmom, osmom i devetom času može se uočiti da se broj učenika sa ocjenom 3 i 2 polako povećava. Na ovim časovima ni jedan učenik nije bio ocijenjen sa najvećom ocjenom 5. Rezultati sa dvanaestog, trinaestog i četrnaestog časa nam ukazuju da učenici sve bolje savladavaju osnovne elemente plivanja i sve više učenika iz klizanja prelaze u plivanje. Može se vidjeti da učenici dobijaju veće ocjene, pa tako su najveću ocjenu 5 na četrnaestom treningu dobila dva učenika (4,08%). Bez obzira na ovakav vid napretka i dalje je najveći broj učenika dobio ocjenu jeda i to 29, što u procentima iznosi 59,18%. Postepeno su učenici dobijali bolje ocjene, a samim tim i sticali znanje plivanja. Tako je u finalnom testiranju ocjenu 1 dobilo 7 učenika i ovim učenicima treba preporučiti novi ciklus osnovne škole plivanja. Razlog zbog kojeg ovi učenici nisu naučili plivati je vjerovatno u tome što pojedinim učenicima treba više vremena da se adaptiraju na vodenu sredinu i proplivaju. Primjećeno je da neki učenici imaju veliki strah od vode (roditelji savjetuju djecu da budu opreznija i time izazivaju strah kod djece), a neki od razloga mogu biti i slabije razvijene motoričke sposobnosti, izostanci s treninga itd. Treba naglasiti da je većina učenika u finalnom mjerenju plivalo kraul tehniku sa pravilnim radom ruku, nogu i disanjem.

ZAKLJUČAK

U ovom istraživanju rezultati zaista pokazuju da je došlo do značajnih pomaka pod uticajem programa. I bez uvida u tabele incijalnog i finalnog testiranja može se konstatovati da su se na kraju programa svi ispitanici adaptirali na vodu i vodenu sredinu i stekli preduslov za daljne aktivnosti kada je u pitanju plivački sport, što je i bio zadatak. Također se može zaključiti da su

se učenici psihološki adaptirali na vodenu sredinu tokom elementarne škole plivanja, a to čini jednu od velikih i važnih uloga kad je u pitanju učenje osnove plivanja, naročito u prvim fazama adaptacije na vodu. Kao što se i očekivalo, dinamika plivanja je po sekvenci bila popraćena rastom rezultata što se može vidjeti iz tabela tranzitivnog mjerenja dužine preplivanih metara bez obzira na tehniku. Generalno, može se zaključiti da su u inicijalnom stanju svi bili neplivači, a u finalnom su se gotovo svi adaptirali na vodu i oko 50% učenika naučilo plivati. Program elementarne škole plivanja koji je bio situacionog obima uticao je pozitivno na transformaciju kod varijable plivačke efikasnosti.

LITERATURA

Atha, J., A. D. Kinnear, and J. S. Sawbridge (1982). Some concomitants affecting the skill adaptation of non-swimmers during a twelve-session training programme. Society of Sports Services Conference; Br J Sports Med. Department of Human Sciences University of Loughborough, 16(2): 110.

Babin, B. (2012). Individualizirani oblik rada u funkciji individualizacije rada u obuci neplivača // Zbornik radova 12. Hrvatskog savjetovanja o obuci neplivača / Ružić, Elida (ur.). Rijeka, Hrvatska: Udruga kineziologa grada Rijeke, 40-41.

Grčić-Zubčević, N., M. Čulina, G. Leko (2002.). Analiza napredovanja učenja plivanja neplivača. U: Zbornik radova 11. Ljetne škole kineziologa Republike Hrvatske, (ur.V.Findak), str. 57-59, Rovinj: Hrvatski kineziološki savez. 7.

Grčić – Zupčević, N. (1996). Efikasnost različitih programa te mogući čimbenici uspješnosti učenja plivanja. Doktorska disertacija, FFK, Zagreb.

Hadžikadunić, M., Mađarević, M. (2004.). Metodika nastave tjelesnog odgoja sa osnovama fiziologije tjelesnog vježbanja. Pedagoški fakultet, Zenica.

Findak, V., Prskalo, I. (2004). Individualizirana obuka plivanja u metode rada. Sport za sve: glasnik Hrvatskog saveza sportske rekreacije. 22 , 39; 29-31.

Madić, D., Okičić, T., Aleksandrović, M. (2007). Plivanje (plivanje). Niš: Srbija.

Tošić, S. (2010). Utjecaj fleksibilnosti na rezultate u plivanju. magistarski rad, Niš, Fakultet sporta i fizičkog vaspitanja.

Topuzov, I. (1999). Classification of the sports depending on the oxidative stress. In I International Scientific Congress „Sport – Stress – Adaptation“. (pp.150 – 152). Bulgaria: National Sports Academy „Vassil Levski“.

Torlakovic, A. (2009). Analysis of dynamics of studying basic swimming elements. 11 th International Conference of Sport Kinetics (IASK), Chalkidiki, Greece, 83-84.

Torlaković, A. (2009). Efekti Intenzivnog procesa učenja osnovnih elemenata plivanja u okviru vannastavnih aktivnosti na djecu mlađeg školskog uzrasta. HomoSporticus-Scientific Journal of Sport and Physical Education, 11(2), 14.18.

Shapiro, D.R., Yun, J., & Ulrich, D.A. (2002). Measuring perceived gross motor skill competence in children. International Journal of Sport Psychology, 33, 391–409.

Rađo, I. (1998). Transformacioni procesi motoričkih i funkcionalnih sposobnosti i različitih aspekata u plivanju. Monografija, FFK, Sarajevo.

Zenić, N. Grčić-Zubčević, N. (2005). Homogeno grupiranje – unapređenje nastave plivanja. Kineziologija, Zagreb, 173-181.

Povezanost motoričkih sposobnosti i nastavne teme stoj na rukama uz okomitu plohu kod jedanestogodišnjih učenica

Lidija Vlahović¹, Bojan Babin², Josip Babin²

¹Filozofski fakultet, Sveučilište u Splitu, Hrvatska

²Kineziološki fakultet, Sveučilište u Splitu, Hrvatska

ABSTRACT

The research was conducted with the aim of determining the relation between motor abilities and representative teaching subject *Handstand against perpendicular surface*, part of *Games* teaching group in the official plan and program of Physical education for the students of fifth grades of elementary schools in the Republic of Croatia. In concordance with the mentioned, 21 motor abilities evaluation test was applied on the sample of 152 female students aged 11, as well as one motor knowledge evaluation test. The results of multiple regression analysis indicated a high degree of relation between motor abilities variables predictor group and the *Handstand against perpendicular surface* criterion variable. The analysis of partial contribution of certain predictor variables in the definition of regression model indicated a statistically significant contribution in seven predictor variables, in the following order of significance: *standing long jump*, *pull up endurance*, *standing on two feet on balance bench with eyes closed*, *trunk lifting*, *standing on one foot on balance bench with eyes closed*, *backwards obstacle test* and *foot tapping*. The results indicated the importance of the choice and frequency of teaching subject *Handstand against perpendicular surface* in the process of planning and programming the Physical education classes, as well as the contribution of the transformation of certain dimensions of motor abilities, with the aim of achieving desired final conditions of female students. Also, the results show which motor abilities should primary be influenced so that the process of observing and evaluating the students would result in better grades during the evaluation of *Handstand against perpendicular surface* teaching subject.

Keywords: fifth grade female students, motor abilities, handstand against perpendicular surface teaching subject, physical education

UVOD

Motorička znanja (kineziološka) predstavljaju one motoričke strukture kretanja čija je primarna funkcija razvoj pojedinih dimenzija antropološkog statusa učenika, i to u prvom redu morfoloških i motoričkih obilježja. Stoga je primarna vrijednost navedenih znanja u mogućnosti da se pojedina antropološka obilježja učenika mijenjaju prema unaprijed definiranom željenom cilju (Babin, 1996; Bavčević i sur., 2008; Babin i sur., 2010). Prilikom razmatranja utilitarnosti i aplikacije procesa učenja pojedinih motoričkih znanja izuzetno je važno voditi računa o dobi pojedinaca, a koju bi trebalo temeljiti na biološkom stupnju razvoja određenih sposobnosti u pojedinim fazama rasta i razvoja. Naime, isključivo primjereno motoričko znanje moguće je djelotvorno usvajati, a što je preduvjet da ono istodobno poprimi funkciju primjerenog kineziološkog stimulusa (Babin, B. i sur., 2013).

Prema Gabbardu (1992) i Sandersu (1992) skupu motoričkih znanja treba posvetiti posebnu pažnju tijekom djetinjstva tj. u predškolskom odgoju i najmlađem školskom uzrastu. Za navedeno, presudnu ulogu imaju kako roditelji tako i sve institucije koje ostvaruju odgojno-obrazovne programe, a posebno značajnu ulogu imaju nastavnici kineziologije (Venetsanou i Kambas, 2009). Učenicima se stoga moraju pružiti optimalni uvjeti za podmirenje potreba za uvježbavanjem svih oblika i vrsta motoričkog znanja, a o čemu se posebno mora voditi računa pri programiranju nastavnog procesa u tjelesnoj i zdravstvenoj kulturi (Gallahue i Ozmun, 1998).

Kako motorička znanja u kineziološkoj edukaciji predstavljaju one motoričke strukture kretanja čija je primarna funkcija razvoj pojedinih dimenzija antropološkog statusa učenika, a prije svega morfoloških i motoričkih obilježja, primarna je vrijednost motoričkih znanja u mogućnosti da se pojedina antropološka obilježja učenika mijenjaju prema unaprijed definiranom željenom cilju (Babin, 1996; Bavčević i sur., 2008; Babin i sur., 2010).

Ovo istraživanje provedeno je s ciljem utvrđivanja povezanosti motoričkih sposobnosti s motoričkim znanjem *Stoj na rukama uz okomitu plohu*, a koje je uzeto kao reprezentativna nastavna tema iz službenog plana i programa tjelesne i zdravstvene kulture za učenice petih razreda osnovne škole.

METODE

Uzorak ispitanika, a u skladu s ciljem istraživanja, sačinjavalo je 152 učenice petih razreda osnovnih škola u Splitu, kronološke dobi 11 godina (± 6 mjeseci). Učenice su pohađale redovitu nastavu tjelesne i zdravstvene kulture po službenom nastavnom planu i programu (Nastavni plan i program za osnovnu školu, 2006). Sve ispitanice bile su klinički zdrave i bez aberantnih pojava.

Za potrebe ovog istraživanja upotrijebljeni su mjerni instrumenti (motorički testovi), koji procjenjuju primarne motoričke sposobnosti i to na način da se reprezentativno obuhvate određene dimenzije hijerarhijskog modela motoričkih sposobnosti (Vlahović, 2012). Na taj način formiran je skup od 21 motoričkog testa kojim se procijenilo sljedeće motoričke sposobnosti:

- **koordinacija** – 1. *Poligon natraške* (MRPOL – šifre testova u tablicama), 2. *Okretnost s palicom* (MKOSP), 3. *Koraci u stranu* (MAKUS);

- **ravnoteža** – 4. *Stajanje na jednoj nozi uzdužno na klupici za ravnotežu s otvorenim očima* (MBU10), 5. *Stajanje na jednoj nozi uzdužno na klupici za ravnotežu sa zatvorenim očima* (MBU1Z), 6. *Stajanje na dvije noge uzdužno na klupici za ravnotežu sa zatvorenim očima* (MBU2Z);

- **fleksibilnost** – 7. *Iskret* (MFISK), 8. *Pretklon raznožno* (MFPRR), 9. *Bočni raskorak* (MFBRs);

- **frekvencija pokreta** – 10. *Taping rukom* (MBTAP), 11. *Taping nogom* (MBTAN), 12. *Taping nogama o zid* (MBTAZ);

- **eksplozivna snaga** – 13. *Skok udalj s mjesta* (MESDM), 14. *Bacanje medicinke iz ležanja na leđima* (MEBML), 15. *Trčanje 20 m iz visokog starta* (ME20V);

- **statička snaga** – 16. *Izdržaj u visu zgebom* (MSVIS), 17. *Horizontalni izdržaj na leđima* (MSHIL), 18. *Izdržaj u polučučnju* (MSIZP);

- **repetitivna snaga** – 19. *Podizanje trupa* (MRDTS), 20. *Sklekovi na koljenima* (MRSNK), 21. *Polučučnjevi* (MRPLČ).

Test motoričkog znanja **Stoj na rukama uz okomitu plohu** (MZSNR) odabran je kao reprezentativna nastavna tema iz nastavne cjeline *Igre* (Nastavni plan i program za osnovne škole, 2006). Test je ocijenilo sedam nezavisnih kompetentnih ocjenjivača neposrednim promatranjem izvedbe učenica. Ocjenjivači su prethodno bili dodatno educirani o načinu i usuglašavanju zadanih kriterija ocjenjivanja. Test je formiran prema sljedećem opisu:

Pomagala: Tri strunjače, okomita ploha (zid), slika zadatka.

Mjesto izvođenja: Školska dvorana za tjelesnu i zdravstvenu kulturu.

Zadatak: Test je iskorakom jedne noge izvesti stoj na rukama.

Opis i pravilna izvedba testa: Ispitanik se nalazi na udaljenosti od dva koraka (1-1,5 m) od zida/strunjače postavljene vertikalno te zauzima stav koračni s osloncem na stražnjoj nozi i uzručenjem s dlanovima okrenutim prema naprijed. Izvodi iskorak prednoženom opruženom nogom prema naprijed. Težina tijela prenosi se na iskoračenu nogu, slijedi pretklon trupom prilikom kojeg ispitanik postavlja opružene ruke dlanovima na tlo u širini ramena na udaljenosti 50-60 cm od iskoračene noge. Energičnim zamahom opružene zamašne noge i odguravanjem od tla odrazne noge tijelo se podiže u stoj na rukama. Prilikom izvođenja stoja na rukama, tijelo se nalazi u okomici, noge su ispružene i skupljene, stopala se dodiruju zida/strunjače, glava je u laganom zaklonu s pogledom usmjerenim u mjesto oslonca, leđa su iz ramena izdužena prema gore. Stoj na rukama zadržava se 3-4 sekunde. Nakon izdržaja stoja na rukama ispitanik se jednom pa drugom nogom spušta na tlo, a istovremeno se odgurava rukama od tla i podiže tijelo iz pretklona do uspravnog stava koračnog s uzručenjem.

Ocjenjivanje: Ispitanik izvodi zadatak jednom i ocjenjuje se ocjenom 1-5.

Kriteriji ocjenjivanja:

OCJENA	OPIS IZVOĐENJA TESTA MOTORIČKOG ZNANJA
5 (odličan)	Ispitanik bez pogrešaka izvodi stoj na rukama
4 (vrlo dobar)	<ul style="list-style-type: none"> - nedovoljno izdužuje tijelo iz ramena u položaj stoja - je nedovoljno dinamičan pri podizanju tijela iz pretklona (kod vraćanja u završni položaj) - nije potpuno pruženog tijela u početnom i završnom položaju - je nedovoljno pruženog tijela prilikom izvođenja zadatka
3 (dobar)	<ul style="list-style-type: none"> - pokazuje nesigurnost u početnom i završnom položaju - nema dinamičan zamah zamašnom nogom - ima nepravilan položaj dlanova u položaju stoja - manje grči laktove u fazi stoja na rukama - je manje uvijenog tijela u položaju stoja - nema dinamično podizanje tijela iz pretklona prilikom vraćanja u završni položaj
2 (dovoljan)	<ul style="list-style-type: none"> - nema početni i završni položaj - ima kratak iskorak („pod sebe“) - preblizu postavlja ruke ispred iskoračene noge - zamahuje pogrčenom zamašnom nogom - ima veliko uvinuće leđa u položaju stoja na rukama - ima jako zaklonjenu glavu u položaju stoja - izrazito istura ramena prema naprijed u položaju stoja - nema dinamičnosti pri podizanju tijela iz pretklona i vraćanja u završni položaj - vidljivo je nestabilan prilikom zadržavanja stoja - grči laktove u fazi stoja na rukama - je previše opušten „mlohav“ kod izvođenja stoja na rukama
1 (nedovoljan)	Ispitanik nije u stanju samostalno izvesti stoj na rukama

S ciljem dobivanja informacija o povezanosti između skupa varijabli motoričkih sposobnosti i varijable motoričkog znanja *Stoj na rukama uz okomitu plohu* primijenjena je multipla regresijska analiza, a u sklopu koje su izračunati: koeficijent multiple korelacije (R), koeficijent determinacije (R^2), standardna pogreška prognoze (σ_e), vrijednost F-testa (F), standardizirani regresijski koeficijent (β), koeficijent linearne korelacije prediktorske varijable (r), vrijednost t-testa (t) i razina značajnosti (p).

Za analizu podataka korišten je softverski paket Statistica for Windows 12.0.

REZULTATI

Tablica 1. Multipla regresijska analiza; kriterijska varijabla – *Stoj na rukama uz okomitu plohu* prediktorski skup – *motoričke varijable*.

(R – koeficijent multiple korelacije, R^2 – koeficijent determinacije, σ_e – standardna pogreška prognoze, F – vrijednost F-testa, β – standardizirani regresijski koeficijent, r – koeficijent linearne korelacije prediktorske varijable i kriterija, t – vrijednost t-testa, p – razina značajnosti)

	R = 0,68	$R^2 = 0,47$	$\sigma_e = 1,00$	F = 5,14	p = 0,00
Varijabla	β	r	t	p	
MRPOL	-0,22	-0,18	-1,98	0,05	
MKOSP	0,04	0,04	0,41	0,69	
MAKUS	-0,13	-0,12	-1,29	0,20	
MBU1O	-0,01	-0,01	-0,07	0,94	
MBU1Z	-0,18	-0,20	-2,23	0,03	
MBU2Z	0,18	0,20	2,29	0,02	
MFISK	0,01	0,01	0,12	0,90	
MFPRR	0,08	0,08	0,88	0,38	
MFBR	-0,03	-0,03	-0,32	0,75	
MBTAP	0,09	0,09	0,99	0,32	
MBTAN	-0,19	-0,18	-2,00	0,05	
MBTAZ	0,14	0,14	1,57	0,12	
MESDM	0,41	0,31	3,60	0,00	
MEBML	-0,00	-0,01	-0,06	0,95	
ME20V	0,12	0,11	1,19	0,24	
MSVIS	0,32	0,27	3,06	0,00	
MSHIL	-0,09	-0,09	-0,95	0,35	
MSIZP	-0,08	-0,09	-0,99	0,32	
MRDTS	-0,20	-0,19	-2,15	0,03	
MRSNK	-0,01	-0,01	-0,11	0,91	
MRPLČ	0,02	0,02	0,22	0,82	

Rezultati multiple regresijske analize ukazuju na visok stupanj povezanosti prediktorskog skupa varijabli motoričkih sposobnosti s kriterijskom varijablom *Stoj na rukama uz okomitu plohu* (MZSNR). Koeficijent multiple korelacije ($R=0,68$) ukazuje kako je značajnu količinu varijance kriterijske varijable moguće pripisati utjecaju prediktorskog skupa varijabli. Statistička značajnost regresijskog modela potvrđena je primjenom F-testa ($F=5,14$; $p=0,00$), pa je moguće ustvrditi da definirani prediktorski skup varijabli motoričkih sposobnosti omogućuje valjanu predikciju vrijednosti kriterijske varijable *Stoj na rukama uz okomitu plohu* (MZSNR). Koeficijent determinacije ($R^2=0,47$) pokazuje vrijednost iz koje je vidljivo da je kriterijsku varijablu moguće objasniti s 47% varijance prediktorskog skupa varijabli. Vrijednost standardne pogreške prognoze ($\sigma_e=1,00$), kao pokazatelja standardne devijacije raspršenosti izmjerenih rezultata oko pravca regresije, ukazuje na nezadovoljavajući stupanj reprezentativnosti regresijskog modela.

Analiza parcijalnog doprinosa pojedinih prediktorskih varijabli u definiranju značajnosti regresijskog modela ukazala je na statistički značajan doprinos kod sedam prediktorskih varijabli. Varijabla *Skok udalj s mjesta* (MESDM) ($\beta=0,41$) pokazala je najviše vrijednosti u doprinosu prognoze kriterijske varijable. Koeficijent korelacije promatrane varijable s kriterijem iznosi 0,31 ($r=0,31$). Statističku značajnost potvrđuju vrijednosti primijenjenog t-testa ($t=3,60$; $p=0,00$). Druga prediktorska varijabla po značajnosti doprinosa u definiranju kriterija je *Izdržaj u visu zgibom* (MSVIS) ($\beta=0,32$). Korelacija povezanosti navedene varijable s kriterijem iznosi 0,27 ($r=0,27$). Statistička značajnost potvrđena je primjenom t-testa ($t=3,06$; $p=0,00$). Treća varijabla po vrijednosti doprinosa u definiranju kriterija je *Stajanje na dvije noge uzdužno na klupici za ravnotežu sa zatvorenim očima* (MBU2Z) ($\beta=0,18$). Koeficijent linearne korelacije navedene varijable s kriterijem iznosi 0,20 ($r=0,20$), a sve je potvrđeno nakon primijenjenog t-testa ($t=2,29$; $p=0,02$). Varijabla *Podizanje trupa* (MRDTS) ($\beta=-0,20$) je četvrta varijabla u količini doprinosa veličini kriterijske varijable. Koeficijent korelacije navedene varijable s kriterijskom varijablom iznosi -0,19 ($r=-0,19$). Navedeni rezultati potvrđeni su primjenom t-testa ($t=-2,15$; $p=0,03$). *Stajanje na jednoj nozi uzdužno na klupici za ravnotežu sa zatvorenim očima* (MBU1Z) je peta po redu u količini doprinosa predikcije kriterijske varijable ($\beta=-0,18$). Veličina koeficijenta korelacije promatrane varijable s kriterijem iznosi -0,20 ($r=-0,20$), a rezultati su potvrđeni primjenom t-testa ($t=-2,23$; $p=0,03$). Šesta varijabla po značajnosti doprinosa u definiranju kriterijske varijable je *Poligon natraške* (MRPOL) ($\beta=-0,22$). Koeficijent korelacije pokazuje vrijednost

od -0,18 ($r=-0,18$). Navedene vrijednosti promatrane varijable potvrdili su rezultati t-testa ($t=-,98$; $p=0,05$). Posljednja varijabla koja pokazuje statističku značajnost koeficijenta u predikciji kriterija je *Taping nogom* (MBTAN) ($\beta=-0,19$). Vrijednosti koeficijenta linearne korelacije navedene varijable s kriterijem iznosi -0,18 ($r=-0,18$), a sve potvrđuje upotrijebljeni t-test ($t=-2,00$; $p=0,05$).

RASPRAVA I ZAKLJUČAK

Na temelju dobivenih rezultata ovog istraživanja moguće je uvidjeti koje su motoričke sposobnosti najinformativnije u procesu vrednovanja motoričkog znanja *Stoj na rukama uz okomitu plohu* kod učenica 5. razreda osnovne škole. To nam ukazuje na važnost tretirane nastavne teme u procesu planiranja i programiranja nastave tjelesne i zdravstvene kulture s obzirom na informaciju koje će motoričke sposobnosti u najvećoj mjeri pridonijeti transformaciji pojedinih motoričkih sposobnosti, a sve u cilju postizanja poželjnih finalnih stanja učenica. Rezultati nedvojbeno ukazuju na visok stupanj povezanosti eksplozivne snage nogu, statičke snage ruku i ramenog pojasa, ravnoteže sa zatvorenim očima, repetitivne snage trupa, koordinacije i brzine frekvencije pokreta s reprezentativnom nastavnom temom *Stoj na rukama uz okomitu plohu* kod jedanaestogodišnjih učenica.

Znači, rezultati dobiveni u ovom istraživanju pružaju uvid u strukturu povezanosti između testa motoričkog znanja *Stoj na rukama uz okomitu plohu* kao reprezentativne nastavne teme iz nastavne cjeline *Igre* za učenice 5. razreda osnovne škole i testova motoričkih sposobnosti. To predstavlja osnovu u razumijevanju transformacijske učinkovitosti nastavne teme *Stoj na rukama uz okomitu plohu* za planiranje i programiranje, a isto tako za praćenje i vrednovanje u nastavi tjelesne i zdravstvene kulture kod učenica 5. razreda osnovne škole. Navedeno će pridonijeti boljem razumijevanju kineziološke edukacije, a posebice u domeni planiranja i programiranja te provedbe i kontrole procesa tjelesnog vježbanja u nastavi tjelesne i zdravstvene kulture.

LITERATURA

Babin, J. (1996). *Utjecaj posebnog programa tjelesne i zdravstvene kulture na neke morfološke karakteristike i motoričke sposobnosti učenika prvog razreda osnovne škole* (Doktorska disertacija). Skoplje: Fakultet za fizičku kulturu Sveučilišta „Sv. Kiril i Metodij“ u Skoplju.

Babin, J., Bavčević, T. i Prskalo, I. (2010). Comparative analysis of the specially programmed kinesiological activity on motor area structural changes of male pupils aged 6 to 8. *Odgojne znanosti*, 12(1), 79-96.

Babin, B., Bavčević, T. i Vlahović, L. (2013). Relations of Motor Abilities and Motor Skills in 11 Year old Pupils. *Croatian Journal of Education*. 15(2), 251-274.

Bavčević, T., Vlahović, L. i Katić, R. (2008). Influence of specially programmed PE lessons on the structure of relation between morphological-motor area and basic kinesiological manifestations of 7-year-old pupils. In D. Milanović & F. Prot (Eds.), *Proceedings Book of 5th International Scientific Conference on Kinesiology „Kinesiology research trends and applications“*, Zagreb, 2008 (pp. 490-494). Zagreb: Faculty of Kinesiology, University of Zagreb.

Gabbard, C. (1992). *Lifelong Motor Development*. Brown: Dubuque

Gallahue, L.D. i Ozmun, C.J. (1998). *Understanding motor development. Infants, children, adolescents, adults*. Boston: McGraw-Hill.

Nastavni plan i program za osnovnu školu (2006). Republika Hrvatska, Zagreb: Ministarstvo znanosti, obrazovanja i športa, na <http://public.mzos.hr/Default.aspx?sec=2197>

Sanders, S.W. (1992). *Designing Preschool Movement Program*. Champaign, IL: Human Kinetics.

Venetsanou, F. i Kambas, A. (2009). Environmental factors affecting preschoolers' motor development. *Early Childhood Education Journal*, 37, 319-327.

Vlahović, L. (2012). *Vrednovanje motoričkih znanja kod učenika petih razreda osnovne škole* (Doktorska disertacija). Split: Kineziološki fakultet Sveučilišta u Splitu.

Razlike u motoričkim sposobnostima kod učenika primarnog obrazovanja prema postotku masnog tkiva u tijelu

Ivan Prskalo, Marko Badrić, Sanja Bogovčić

Učiteljski fakultet, Sveučilište u Zagrebu, Hrvatska

ABSTRACT

The aim of this research is to determine whether there is a difference in the motor skill levels with regards to the body fat percentage present in boys and girls attending the fourth grade of primary school. The research was conducted on a test sample of 87 fourth-grade primary school pupils. The sample consisted of 50 boys aged $10,48 \pm 0,51$ years and 37 girls aged $10,19 \pm 0,40$ years. The pupils attended two primary schools in the town of Petrinja, Croatia – *DragutinTadijanović Primary School* and the *PetrinjaFirst Primary School*. The sample variables consisted of the following anthropometric measures: body height, body weight, triceps skinfold, subscapular skinfold and abdominal circumference. Motor skill levels were measured with 4 motor skill tests – hand tapping, standing long jump, sit-ups and 10x5 meter runs. To estimate the body fat percentage present in the organism, we used the sum of the triceps skinfold and the subscapular skinfold. The results of the variance analysis (ANOVA) have shown that there is a statistically significant difference in some motor skills in boys classified according to body fat percentage. Boys who have an acceptable body fat percentage have demonstrated significantly better results regarding explosive strength and agility than boys who were obese. Among the researched sample of girls of the same age, it is evident that girls with a normal body fat percentage had statistically significantly better results in explosive strength tests. Based on the analysed research results, a conclusion can be made that obese boys and girls have less developed motor skills. The differences are most evident in the skills that require movability through space.

Keywords: body fat percentage, pupils, motor skills, obesity

UVOD

Pretilost je prepoznata kao jedan od najtežih javnozdravstvenih izazova i činjenica je da se pretilost u djetinjstvu, posebice u zadnjih nekoliko godina povećala (Castetbon&Andreyeva, 2012; Ogden, i sur., 2012). Zahvaćena populacija djece nije uočena samo kod ekonomski razvijenih zemalja, već i onih koji imaju manji ekonomski standard (Wang i Lobstein, 2006., Casajús i sur., 2007., D'Hondt i sur., 2008., Martins i sur., 2010.). Istraživanjaukazuju na to dapretilosti u djetinjstvu može imatinegativne učinkena ukupanmotorički razvoj (Morano i sur., 2011). Osim toga, pretila i prekomjerno teška djece imaju tendenciju da imaju slabije razvijene motoričke sposobnosti u usporedbi sa svojim vršnjacima s normalnom tjelesnom težinom (D'Hondt i sur., 2009; Logan i sur., 2011;.. Morano i sur., 2011; Poulsen i sur., 2011). Hardy i suradnici (2012) navode da su djeca koja imaju nisku razinu motoričkih sposobnosti vrlo malo uključena u tjelesnu aktivnost, te rjeđe sudjeluju u sportu i organiziranim igrama.Motoričke sposobnosti možemo okarakterizirati kao kompleksan sustavkoji se očituje u ljudskom pokretu. Njihove karakteristike ponajprije zavise odnjihove razvijenosti, a prisutne su u svakodnevnom životu kod svih generacija.Važne su, kako za obavljanje običnih dnevnih aktivnosti, tako i za provođenjerazličitih aktivnosti koje su povezane s tjelesnim vježbanjem, sportom irekreacijom. Razvoj pojedinca odražava se u kvantitativnim i kvalitativnimpromjenama, koje proizlaze iz nižih u značajno viša razvojna stanja saspecifičnom funkcionalnom organiziranošću (Kovač, 1999).Motoričke sposobnosti, to jest njihova razina, vrlo su važne za optimalan rast i razvoj djece, a samim time i za njihovo zdravlje. Svakako je bitna činjenica, da bi motoričke sposobnosti imale kvalitetan razvoj i dostigle optimalnu razinu potrebno je kontinuirano i sustavno tjelesno vježbanje djece (Badrić, 2011). **Cilj** ovog istraživanja bio je utvrditi postoji li razlika u razini motoričkih sposobnosti s obzirom na postotak masti u organizmu kod dječaka i djevojčica četvrtog razreda osnovne škole.

METODE

Za potrebe istraživanja korišten je uzorak od 87 učenika četvrtih razreda osnovne škole. Uzorak ispitanika činilo je 50 dječaka prosječne dobi $10,48 \pm 0,51$ godina i 37 djevojčica prosječne dobi $10,19 \pm 0,40$ godina. Ispitivani učenici

pohađali su dvije osnovne škole sa područja grada Petrinje, Osnovnu školu Dragutina Tadijanovića i Prvu Osnovnu školu Petrinja. Svi učenici bili su potpuno zdravi u vrijeme provođenja istraživanja. Istraživanje je provedeno u skladu s Etičkim kodeksom istraživanja s djecom koji je pripremila Vijeće za djecu kao savjetodavno tijelo Vlade Republike Hrvatske. Za svakog ispitanika roditelji su dali pismeni pristanak za sudjelovanje u istraživanju. Uzorak varijabli u ovom istraživanju sastojao se antropometrijskih mjera tjelesna visina, tjelesna težina, kožni nabor nadlaktice, kožni nabor leđa, opseg trbuha. Sve mjere provedene su prema Internacional Biological Program (IBP - Weiner i Lourie, 1968). Visina tijela izmjerena je uz pomoć antropometra, a tjelesna masa uz pomoć digitalne vage. Kožni nabori izmjereni su Langeovim Skinfolddkaliperom. Motoričke sposobnosti mjerene su skupom od četiri motorička testa. Za procjenu brzine jednostavnih pokreta korišten je test *Taping rukom*. Eksplozivna snaga provjeravana je testom *Skok u dalj s mjesta*. Za procjenu repetitivne snage korišten je test *Podizanje trupa*, a agilnost i brzina provjeravani su testom *Trčanje 10x5 metara*. Za procjenu postotka masti u organizmu korištena je suma kožnog nabora leđa i kožnog nabora nadlaktice prema Slaughterovoj jednadžbi (Slaughter i sur., 1998). Klasifikacija ispitanika prema postotku masti napravljena je prema McCarthy i suradnicima (McCarthy HD, Cole TJ, Fry T, Jebb SA, Prentice AM. 2006) sa definiranim centilnim krivuljama specifičnima za djecu s obzirom na spol i dob i podjelom na normalnu tjelesnu težinu (2-85 centila), prekomjernu tjelesnu mast (85-95 centila) i pretilost (preko 95 centila).

Obrada podataka je obavljena programom STATISTICA (data analysis software system), version 7.1. Pri obradi podataka za sve istraživane varijable izračunati su osnovni deskriptivni parametri: aritmetička sredina, standardna devijacija te minimalan i maksimalan rezultat. Normalnost distribucije varijabli testirana je Kolmogorov-Smirnovljevim testom. Značajnost razlika između formiranih subuzoraka prema stupnju postotka mastite antropometrijskih karakteristika i motoričkih sposobnostitestirana je analizom varijance (ANOVA). Kod varijabli gdje je postignuta statistički značajna F vrijednost u daljnjoj analizi koristio se Scheffepost hoc test za utvrđivanje razlika između aritmetičkih sredina skupina. Statistička značajnost razlika testirana je na razini značajnosti $p < 0,05$.

REZULTATI

Rezultati deskriptivnih parametara za dječake i djevojčice koji su obuhvaćeni istraživanjem prikazani su u slijedećim tablicama.

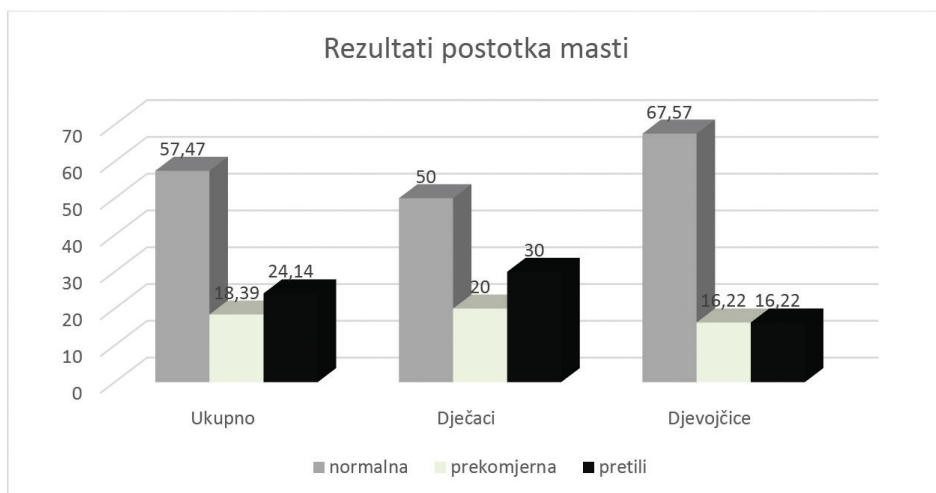

Slika 1. Postotak učenika prema postotku masti u organizmu

Rezultati u slici 1. prikazuju da je postotak učenika ukupnog uzorka koje su normalne tjelesne masti oko 57%. Kada se pogledaju rezultati prema spolu, vidljivo je da veći broj djevojčica ima postotak masti u organizmu u granicama prihvatljivosti. Gledajući uzorak istraživanih učenika, vidi se da gotovo 50% dječaka ima prekomjerni postotak masti ili su već u stupnju pretilosti, dok se kod djevojčica ovaj broj kreće oko 33%.

Tablica 1. Deskriptivni statistički parametri antropometrijskih karakteristika i motoričkih sposobnosti za dječake 4. razreda i ANOVA test za utvrđivanje razlika

	N	AS	SD	MIN	MAX	K-S test	F	p-razina
Tjelesna visina	50	147,56	7,07	130,50	166,00	p > .20	5,33	0,01
Tjelesna težina	50	41,73	11,01	24,70	69,50	p > .20	47,38	0,00
Kožni nabor leđa	50	13,22	6,87	4,10	29,30	p > .20	59,13	0,00
Kožni nabor nadlaktice	50	15,99	7,16	4,90	33,60	p > .20	62,09	0,00
% masti	50	24,31	8,72	10,35	43,61	p > .20	78,67	0,00
Opseg trbuha	50	68,74	12,06	48,50	94,00	p < ,20	55,82	0,00
Taping rukom	50	24,90	6,66	16,00	62,00	p < ,10	0,40	0,67
Skok u dalj s mjesta	50	131,16	21,26	70,00	178,00	p > .20	11,35	0,00
Podizanje trupa	50	34,04	7,96	19,00	48,00	p > .20	1,64	0,21
Trčanje 10x5 metara	50	24,06	2,84	18,32	34,48	p > .20	3,86	0,03

N= broj ispitanika; AS= aritmetička sredina; SD= standardna devijacija; MIN= minimalan rezultat; MAX= maksimalan rezultat; K-S test=Kolmogorov-Smirnovljevi test

Deskriptivni parametri pokazuju u tablici 1. da je normalnost distribucije zadovoljavajuća. Rezultati univarijantne analize varijance (ANOVA) pokazuju da se značajna razlika između grupa podijeljenih na tri subuzorka definiranih prema stupnju postotka masti u organizmu očituje u varijablama kojima se procjenjuju morfološke karakteristike, te od motoričkih sposobnosti eksplozivna snaga i agilnost. Kod varijabli koje procjenjuju repetitivnu snagu i brzinu jednostavnih pokreta nema statistički značajnih razlika.

Tablica 2. Deskriptivni statistički parametri antropometrijskih karakteristika i motoričkih sposobnosti za djevojčice 4. razreda i ANOVA test za utvrđivanje razlika

	N	AS	SD	MIN	MAX	K-S test	F	p-razina
Tjelesna visina	37	149,50	5,95	136,10	158,90	p > .20	0,52	0,60
Tjelesna težina	37	40,68	8,25	28,10	57,50	p > .20	19,19	0,00
Kožni nabor leđa	37	12,83	6,22	4,60	30,00	p < .20	42,29	0,00
Kožni nabor nadlaktice	37	16,68	4,35	10,10	25,60	p < .20	17,80	0,00
% masti	37	25,20	6,64	16,77	44,04	p > .20	63,98	0,00
Opseg trbuha	37	65,22	8,04	53,10	81,00	p > .20	35,72	0,00
Taping rukom	37	23,81	3,43	18,00	30,00	p > .20	1,98	0,15
Skok u dalj s mjesta	37	122,62	17,50	97,00	160,00	p > .20	10,83	0,00
Podizanje trupa	37	33,49	10,52	14,00	66,00	p > .20	1,19	0,32
Trčanje 10x5 metara	37	25,14	2,45	19,47	29,33	p > .20	3,19	0,05

*statistička značajnost p<0,05; a= normalna-prekomjerna; b=normalna-pretili; c= prekomjerna – pretili;N= broj ispitanika;

AS= aritmetička sredina; SD= standardna devijacija; F= koeficijent analize varijance;p=razina statističke značajnosti

U tablici 2. prikazani su deskriptivni parametri za uzorak djevojčica. Rezultati Kolmogorov - Smirnov testa pokazali su normalnost distribucije. Rezultati univarijantne analize varijance (ANOVA) pokazuju da se značajna razlika između grupa podijeljenih na tri subuzorka definiranih prema stupnju postotka masti u organizmu očituje u varijablama kojima se procjenjuju morfološke karakteristike, osim kod mjere tjelesne visine. Kod motoričkih sposobnosti značajna razlika pojavljuje se u varijabli za procjenu eksplozivne snage. Kod varijabli koje procjenjuju repetitivnu snagu i brzinu jednostavnih pokreta te agilnost nema značajnih razlika.

Tablica 3. Deskriptivni statistički parametri antropometrijskih karakteristika i motoričkih sposobnosti za dječake 4. razreda prema razini postotka masti i Scheffe post hoc test za utvrđivanje razlika između skupina

	Normalna tjelesna masa	Prekomjerna tjelesna masa	Pretili
	N=25	N=10	N=15
	AS±SD	AS±SD	AS±SD
Tjelesna visina	144,96±6,45	147,55±5,11	151,91±7,38 ^a
Tjelesna težina	33,65±5,46	43,27±5,12 ^a	54,15±8,53 ^{b/c}
Kožni nabor leđa	8,03±3,52	14,13±2,51 ^a	21,28±4,67 ^{b/c}
Kožni nabor nadlaktice	10,34±3,92	17,90±3,63 ^a	24,11±3,81 ^{b/c}
% masti	17,22±5,21	26,76±1,39 ^a	34,48±3,68 ^{b/c}
Opseg trbuha	59,60±6,01	70,79±6,09 ^a	82,60±8,07 ^{b/c}
Taping rukom	24,32±4,20	24,40±2,55	26,20±10,88
Skok u dalj s mjesta	141,60±18,06	131,00±11,75	113,87±20,47 ^b
Podizanje trupa	35,12±8,35	35,90±8,63	31,00±6,32
Trčanje 10x5 metara	22,89±2,31	22,30±2,00	25,34±3,29 ^{b/c}

*statistička značajnost $p < 0,05$; a= normalna-prekomjerna; b=normalna-pretili; c=prekomjerna – pretili; N= broj ispitanika;

AS= aritmetička sredina; SD= standardna devijacija; F= koeficijent analize varijance;p=razina statističke značajnosti

Temeljem dobivenih statistički značajnih razlika koje su se utvrdile kod pojedinih varijabli u daljnjoj analizi koristio se *post hoc* Scheffe test za utvrđivanja pojedinačnih razlika između skupina ispitanika. Rezultati pokazuju da se kod varijable *Tjelesna visina*, pretili dječaci značajno viši od dječaka normalne tjelesne mase. Kod ostalih varijabli za procjenu morfoloških karakteristika (tjelesna težina, kožni nabor leđa i nadlaktice, postotak masti u organizmu, opseg trbuha) vidljivo je da su dječaci koji imaju prekomjerna postotak masti u organizmu ili pripadaju u skupinu pretelih, imaju više vrijednosti od dječaka normalne tjelesne mase. Kod varijabli za procjenu motoričkih sposobnosti značajne razlike pojavljuju se u prostoru eksplozivne snage gdje su dječaci normalne tjelesne mase postigli značajno bolje rezultate od pretelih dječaka.

U varijabli kojom se procjenjuje agilnost, dječaci koji su pretili imaju značajno slabije rezultate od dječaka normalne i prekomjerne tjelesne mase.

Tablica 4. Deskriptivni statistički parametri antropometrijskih karakteristika i motoričkih sposobnosti za djevojčice 4. razreda prema razini postotka masti i Scheffe post hoc test za utvrđivanje razlika između skupina

	Normalna tjelesna masa	Prekomjerna tjelesna masa	Pretili
	N=25 AS±SD	N=6 AS±SD	N=6 AS±SD
Tjelesna visina	148,88±5,63	151,62±4,71	149,95±8,54
Tjelesna težina	36,66±6,08	47,03±5,75 ^{*a}	51,10±4,41 ^{*b}
Kožni nabor leđa	9,56±3,06	15,82±3,43 ^{*a}	23,43±4,82 ^{*b/c}
Kožni nabor nadlaktice	14,56±3,13	20,95±2,47 ^{*a}	21,27±3,65 ^{*b}
% masti	21,41±2,99	29,58±1,01 ^{*a}	36,60±4,77 ^{*b/c}
Opseg trbuha	60,87±5,09	71,10±4,43 ^{*a}	77,45±2,52 ^{*b}
Taping rukom	23,84 ±3,61	25,67±2,66	21,83±2,48
Skok u dalj s mjesta	130,08±15,41	106,83±12,06 ^{*a}	107,33±7,87 ^{*b}
Podizanje trupa	34,24±11,72	36,17±5,49	27,67±7,45
Trčanje 10x5 metara	25,29±2,46	23,20±0,95	26,49±2,51

*statistička značajnost $p < 0,05$; a= normalna-prekomjerna; b=normalna-pretili; c= prekomjerna –pretili
N= broj ispitanika; AS= aritmetička sredina; SD= standardna devijacija

U tablici 4. prikazani su rezultati *post hoc*analize. Scheffe testom izvršila se analiza kod varijabli koje su utvrdile statističku značajnost. Rezultati pokazuju da se kod varijabli za procjenu morfoloških karakteristika tjelesna težina, kožni nabor leđa i nadlaktice, postotak masti u organizmu, opseg trbuha djevojčice normalne tjelesne mase imale niže vrijednosti od pretelih djevojčica ili onih sa prekomjernim postotkom masti u organizmu. Isto tako, vidljivo je da djevojčice prekomjerne tjelesne mase imaju značajno niži postotak masti u organizmu od pretelih djevojčica. Kod varijabli za procjenu motoričkih sposobnosti značajne razlike pojavljuju se u prostoru eksplozivne snage, dok se kod ostalih istraživanih varijabli razlike uočavaju ali nisu statistički značajne.

RASPRAVA

Istraživanje je imalo za cilj utvrditi razlike u razini motoričkih sposobnosti s obzirom na postotak masti u organizmu kod dječaka i djevojčica četvrtog

razreda osnovne škole. Rezultati istraživanja pokazali su da kod dječaka koji su klasificirani prema postotku masti postoji statistički značajna razlika samo u nekim motoričkim sposobnostima. Dječaci koji imaju prihvatljiv postotak masti pokazali su značajno bolje rezultate u prostoru eksplozivne snage i agilnosti od dječaka koji su pretili. Slične rezultate u testovima koji zahtijevaju mobilnost pokreta donjih ekstremiteta i gdje je povećana tjelesna masa otežavajući faktor vidljivi su u istraživanjima (Siahkouhian, 2011; Drid i sur., 2013). Učenici koji imaju više masnog tkiva pokazuju značajno slabije rezultate u izvođenju motoričkih testova kojima je povećana tjelesna težina ograničavajući faktor u izvođenju pokreta (D'Hondtetal., 2013; Lopes i sur. 2012).

Razlike se ne uočavaju u prostoru motoričkih varijabli gdje povećana tjelesna težina nije preduvjet za efikasno izvođenje pokreta (taping rukomprocjena brzine jednostavnih pokreta, ali i kod testa za procjenu repetitivne snage gdje su vidljive rezultatske razlike koje nisu statistički značajne. Vjerojatan razlog ovako dobivenih rezultata može biti u nemotiviranosti kod izvođenju ovog testa. Gledajući rezultate djevojčica iste dobi, vidljivo je da one normalnog postotka masnog tkiva imaju statistički značajno bolje rezultate u testovima za procjenu eksplozivne snage (Drid i sur., 2013., Castetbon i Andreyeva, 2012). U ostalim varijablama nisu uočene značajne razlike što se kao i kod dječaka može pripisati problemu motiviranosti u izvođenju ovih testova.

Rezultati antropometrijskih karakteristika pokazuju da dječaci koji pripadaju skupini prekomjerne tjelesne mase ili su pretili, imaju značajno povećan postotak masti, veće vrijednosti kožnih nabora, opseg trbuha te svakako veću tjelesnu težinu. Razlike su također uočene između skupina dječaka prekomjerne tjelesne mase i pretilih, gdje pretili učenici imaju značajno više vrijednosti antropometrijskih karakteristika. Rezultati kod djevojčica pokazuju slične vrijednosti rezultata to jest djevojčice koje imaju povećanu tjelesnu masu ili su pretile, imaju značajno više rezultate u tjelesnoj težini, postotku masti, kožnih nabora i opsegu trbuha. Temeljem rezultata dobivenih istraživanjem vidljivo je da postoje razlike u razini motoričkih sposobnosti između učenika klasificiranih prema postotku masti u organizmu. Ove razlike nisu značajno potvrđene u svim istraživanim varijablama motoričkog prostora. Iako, mora se napomenuti da i ovako dobiveni rezultati pokazuju više vrijednosti kod učenika koji imaju prihvatljiv postotak masnog tkiva u organizmu.

ZAKLJUČAK

Temeljem analiziranih rezultata istraživanja može se zaključiti da dječaci i djevojčice koji su pretili imaju slabije razvijene motoričke sposobnosti. Najveće razlike očituju se u sposobnostima koje zahtijevaju pokretnost vlastitog tijela u prostoru. Važno je napomenuti potrebu ranog fokusiranja na razvoj motoričkih sposobnosti i poticanje pretile djece da se što prije uključe u tjelesnu aktivnost radi očuvanja vlastitog zdravlja.

LITERATURA

Badrić, M. (2011). Povezanost kinezioloških aktivnosti u slobodnom vremenu i motoričkih sposobnosti učenika srednje školske dobi: doktorski rad

Casajus JA, Leivia MT, Villarroya A, Legaz A, Moreno LA. (2007) Physical performance and school physical education in overweight Spanish children. *AnnNutrMetabol*,51, 288–296.

Castetbon, K. and Andreyeva, T.(2012) Obesity and motor skills among 4 to 6- year-old children in the United States: Nationally representative surveys. *BioMed Central Pediatrics*, vol. 12, issue 1, pp 28.

D'Hondt E, Deforche B, De Bourdeaudhuij I, Lenoir M. Relationship Between Motor Skill and Body Mass Index in 5- to 10-Year-Old Children Adapted Physical Activity Quarterly, 2009; 26, (1) 21-37

D'Hondt, E., Deforche, B., Gentier, I., De Bourdeaudhuij, I., Vaeyens, R., Philippaerts, R. et al.(2013) A longitudinal analysis of gross motor coordination in overweight and obese children versus normal-weight peers *Int J Obes (Lond)*, 37, pp. 61–67

D'Hondt, E., Deforche, B., I. De Bourdeaudhuij, I. and Lenoir, M. (2008) Childhood obesity affects fine motor skill performance under different postural constraints. *Neuroscience Letters*, vol. 440, issue 1, , pp 72-75.

Drid P, Vujkov S, Jaksić D, Trivić T, Marinković D, Bala G. (2013) Differences in motor and cognitive abilities of children depending on their body mass index and subcutaneous adipose tissue. *Coll Antropol*.37 Suppl 2:171-7

Hardy, L., Reiten-Reynolds, T., Espinel, P., Zask, A., & Okely, A. (2012). Prevalence and correlates of low fundamental movement skill competency in children. *Pediatrics*, 130, e390–e398 10.1542/peds2012-0345.

Kovač, M. (1999). Analizapovezav med nekaterimigibalnim sposobnostmi in fluidnointeligenostjoučenk, starihod 10 do 18 let. (Doctoral dissertation, University of Ljubljana). Ljubljana: Faculty of sport, University of Ljubljana

Logan, S. W., Robinson, L. E., Wilson, A. E., & Lucas, W. A. (2011). Getting the fundamentals of movement: a meta-analysis of the effectiveness of motor skill interventions in children. *Child: care, health and development*, 38, 305-315.

Lopes, VP., Stodden, DF., Bianchi, MM., Maia, JA., Rodrigues, LP. (2012) Correlation between BMI and motor coordination in children. *J Sci Med Sport*, 15:38-43.

Martins, D., Maia, J., Seabra, A., Garganta, R., Lopes, V., Katzmarzyk, P., Beunen, G. (2010) Correlates of changes in BMI of children from the Azores islands, *International Journal of Obesity*; Vol. 34 Issue 10, p1487

McCarthy HD, Cole TJ, Fry T, Jebb SA, Prentice AM. (2006). Body fat reference curves for children. *Int J Obes*, 30, 598-602

Morano M, Colella D, Caroli M. (2011) Gross motor skill performance in a sample of overweight and non-overweight preschool children. *Int J Pediatr Obes*, 6(Suppl 2):42-46.

Ogden, C.L., Carroll, M.D., Kit, B.K., Flegal, K.M. (2012). Prevalence of obesity and trends in body mass index among US children and adolescents, 1999–2010. *Journal of the American Medical Association*, 307 (5), 483–490

Poulsen AA, Desha L, Ziviani J, Griffiths L, Heaslop A, Khan A, et al. (2011) Fundamental movement skills and self-concept of children who are overweight. *Int J Pediatr Obes*, 6:e464-e471.

Siakhohian M, Mahmoodi H, Salehi M. Relationship between fundamental movement skills and body mass index in 7 to 8 year old children. *World Applied Sci J*. 2011;15:1354–1360.

Slaughter MH, Lohman TG, Boileau RA, Horswill CA, Stillman RJ, van Loan MD, et al. (1988). Skin fold equations for estimation of body fatness in children and youth. *Hum Biol*, 60,709–23

Wang Y, Lobstein T. (2006) Worldwide trends in childhood overweight and obesity. *Intl Pediatr Obes*, 1:11-25.

The effects of physical activity on academic performance and physical fitness in elementary school girls

Vedrana Sember, Shawnda A. Morrison

University of Primorska, Koper, Slovenia

ABSTRACT

Physical activity significantly affects a number of learning factors which have been established as reliable predictors of increased academic performance in children. These include: children's self-esteem, body image (Nelson & Gordon-Larsen, 2006), concentration (Catering & Polak, 1999) and behaviour outcomes in the classroom (Evans et al. 1985). Physical activity not only has a positive impact on overall health (Powell & Pratt, 1996; Batty & Thune, 2000), but also on cognitive function (Shephard, 1997; Donnelly, Green & Gibson, 2009), mood (Biddle & Mutrie, 2001; Tomson et al. 2003) and executive function (Best, 2010). It has been well-established that physical activity minutes and the overall health of Slovenian schoolchildren is declining, attributed to 2004, when Slovenia became a member of European Union and its physical education lessons were cut for the first time in the nation's history (Kovač et al. 2011). In particular, girls in Slovenia are becoming more physically weak (Starc, Strel & Kovač, 2010), yet the epidemiological link between physical activity and academic performance outcome measures have not been clearly established in Slovenia.

OBJECTIVE

To determine the extent to which increased physical activity minutes will correlate to enhanced academic performance in school-aged girls in Slovenia.

METHODS

Physical activity counts are being measured in fifteen 11-12 year-old elementary school girls (1-axis accelerometers) for 5-d, comprising of: 3 school

days (Wednesday, Thursday, Friday) and 2 weekend days (Saturday, Sunday). Physical activity data are then correlated to academic outcome measures, including: math grades (school documentation from standardised testing), and to indices of physical fitness (SLOFIT, the Slovenian National database of annual physical activity testing) using two-way bivariate correlations.

RESULTS

Data collection is ongoing at the time of abstract submission. Full data sets, including statistical analyses, will be presented at the conference in Split, Croatia.

CONCLUSIONS

There is very few data available investigating the effects of increased physical activity and academic performance in elementary school-aged girls. Data from this research will inform government and policy makers on optimal physical activity standards in the Slovenian national school system.

Key words: physical activity, academic performance, cognition, mathematics, girls.

REFERENCES

- Batty, D., Lee, I.M. (2004). Physical activity and coronary heart disease. *Br Med*, 328, 1089-1890.
- Batty, D., Thune, I. (2000). Does physical activity prevent cancer? *Br Med*, 321, 1424- 5.
- Best, J.,R. (2010). Effects of physical activity on children's executive function: Contributions of experimental research on aerobic exercise. *Developmental review*, 30(4), 331-351
- Biddle, S.J.H. & Mutrie, N. (2001). Psychology of physical activity. Determinants, well-being and interventions. Routledge, New York (2001)
- Catering, M.C. & Polak, E.D. (1999). Effects of two types of activity on the performance of second-, third-, and fourth-grade students on a test of concentration. *Perceptual and motor skills*, 89, 245-248.
- Donnelly, J.,E., Green, J.I., Gibson, C.A., e tal. (2009). Physical Activity Across the Curriculum (PAAC): a randomized controlled trial to promote physical

activity and diminish overweight and obesity in elementary school children. *Prev. Med*, 49, 336-341.

Evans, W.H., Evans, S.S., Schmid, R.E. & Penneypacker, H.S. (1985). The effects of exercise on selected classroom behaviors of behaviorally disordered adolescents. *Behavior Disorders*, 11, 42-50.

Kovač, M., Jurak, G., Starc, G., & Strel, J. (2011). The importance of research-based evidence for political decisions on physical education. In: Hardman, K., Green, K., editors. *Contemporary Issues in Physical Education: International Perspectives*. Maidenhead, UK: Meyer & Meyer Sport; p. 47-68

Nelson, M.C. & Gordon-Larsen, P. (2006). Physical activity and sedentary behavior patterns associated with selected adolescent health risk behaviors. *Pediatrics* 2006, 117, 1281-1290.

Powell, K.E., Pratt, M. (1996). Physical activity and health. *Br Med J*, 313, 126-127.

Shephard, R. J. (1997). Curricular physical activity and academic performance. *Pediatric Exercise Science*, 9, 113-126

Starc, G., Strel, J., & Kovač, M. (2010). *Telesni in gibalni razvoj slovenskih otrok in mladine v številkah. Solsko leto 2007/08*. (Physical and motor development of Slovenian children and youth in figures. 2007/08 academic year) Ljubljana: Fakulteta za šport.

Tomson, R.P., Pangrazi, G., Friedman, N. & Hutchinson, N. (2003). Childhood depressive symptoms, physical activity and health related fitness. *Journal of Sport and Exercise Psychology*, 25 (2003), 419-439

Razina usvojenosti dvaju programa sportske gimnastike od strane studentica

Matea Malada¹, Sunčica Delaš Kalinski¹, Lenče Aleskovska-Veličkovska²,
Nevenka Maras¹

¹Faculty of Kinesiology, University of Split, Croatia

*²Ss. Cyril And Methodius University, Faculty of Physical Education, Skopje,
Macedonia*

ABSTRACT

Curriculums of Artistic gymnastic 1 and Artistic Gymnastic 2 at the Faculty of Kinesiology in Split, are primarily aimed to capacitate future teachers of physical education demonstrate, to use different teaching methods and to assist in performance of various gymnastic skills. The aim of the study was to determine the level to which students (N=80) can adopt prescribed skills from the curriculums of Artistic gymnastic 1 and 2, and to determine whether the programs on individual devices are mutually aligned. The research results have identified that students in both courses, on all apparatus, generally practice with lower technical and/or aesthetic errors (for school mark very good - 4) and that in spite of the same "school marks" there are some differences among the apparatuses. The bigger difference has been determined between apparatuses in Artistic gymnastics 2 than between apparatuses in Artistic gymnastic 1.

Key words: artistic gymnastic skills, post hoc ANOVA, Bonferonni correction

UVOD

Program Kineziološkog fakulteta u Splitu (KIF) primarno je usmjeren osposobljavanju studenata za rad u tjelesnoj i zdravstvenoj kulturi u osnovnim i srednjim školama. Sukladno tome, kurikulumi pojedinih predmeta konstruirani su tako da osposobljavaju studente, buduće magistre kineziologije, za provedbu svih sadržaja predviđenih kurikulumima tjelesne i zdravstvene kulture osnovnih i srednjih škola, ali i nešto kompleksnijih sadržaja primjenjivih u drugim kineziološkim područjima.

Na drugoj godini sveučilišnog preddiplomskog studija studenti slušaju predmete Sportska gimnastika 1 (SG1) i Sportska gimnastika 2 (SG2). Uz različita teoretska saznanja o sportskoj gimnastici glavni cilj ovih predmeta je naučiti studente izvedbu bazičnih (SG1) i jednostavnijih (SG2) gimnastičkih znanja, načine poučavanja i asistiranja prilikom izvedbe istih. Pri tom je važno istaknuti da, iako se radi o dva sadržajno potpuno različita programa, među znanjima koja se uče na ovim predmetima postoji pozitivan transfer (Erceg, 2010). Štoviše, nesavladanost znanja iz SG1, koja su najčešće dio metodskih postupaka znanja iz SG2, onemogućava studentu/studentici savladavanje znanja u SG2.

S obzirom na činjenice: 1) da se s gimnastičkim znanjima studenti/studentice najčešće po prvi puta susreću na fakultetima (Hraski, 2004); 2) da gimnastički sport polako „nestaje“ iz školskih programa (Cvitak, 1999); 3) da se znanja koja su lošije naučena u periodu neponavljanja više zaboravljaju (Schmidt i Lee, 2005); 4) da se neovisno o razini usvojenosti znanja sposobnost izvedbe nekog znanja mijenja tijekom vremena; postavilo se pitanje da li su programi iz sportske gimnastike, za buduće nastavnike tjelesne i zdravstvene kulture, njima dobro prilagođeni, odnosno do koje razine, u tijeku jednog semestra, oni mogu usvojiti ta znanja. Sukladno tome, cilj rada je bio utvrditi razinu do koje studentice mogu usvojiti propisana znanja iz programa sportske gimnastike 1 i sportske gimnastike 2 te utvrditi da li su programi na pojedinim sprava međusobno usklađeni.

METODE RADA

Uzorak ispitanika sačinjavalo je ukupno 80 studentica Kineziološkog fakulteta u Splitu, polaznica drugih godina preddiplomskog sveučilišnog studija u akademskim godinama 2010/2011, 2011/2012, 2012/2013 i 2013/2014. One su, pod vodstvom istog nastavnika, pohađale većim dijelom identičan program iz kolegija Sportske gimnastike 1 (SG1) i Sportske gimnastike 2 (SG2) u ukupnom trajanju od 112 sati (60 sati u SG1: 2 sata praktičnih seminara, 2 sata kinezioloških vježbi tjedno tijekom 15 tjedana; 52 sata u SG2: 2 sata seminara, 2 sata kinezioloških predavanja tjedno tijekom 13 tjedana). Prema vlastitim sklonostima i potrebama studentice su u slobodno vrijeme vježbale sportsku gimnastiku, ali i ostale sportove iz programa studija, kao i one koje provode u slobodno vrijeme.

Uzorak varijabli predstavljala su znanja iz kolegija SG1 i SG2 koja su za analizirane generacije studentica bila ista na preskoku, dvovisinskim ručama, gredi, tlu i karikama. Sva znanja bila su ocjenjena od strane službenog nastavnika prema generalnim gimnastičkim kriterijima ocjenjivanja, na Likertovoj skali od 1 – 5, ali s mogućnošću dobivanja i „među-ocjene“ (npr. ocjene 4/5; Delaš, 2005; Delaš Kalinski, 2009).

Za svako znanje utvrđena je prosječna vrijednost, a iz prosječnih vrijednosti svih znanja na jednoj spravi utvrđena je prosječna vrijednost svake sprave. Prosječnim vrijednostima sprava utvrđeni su deskriptivni statistički parametri: aritmetička sredina (AS), standardna devijacija (SD), minimalna vrijednost (MIN), maksimalna vrijednost (MAX), simetričnost distribucije rezultata (Skewness - SKEW), oblik distribucije rezultata (Kurtosis - KURT) te Kolmogorov –Smirnovljevi test normaliteta distribucije rezultata. ANOVA za ponovljena mjerenja je korištena za identifikaciju razlika, a korištenjem Bonferroni korekcije su napravljene višestruke usporedbe među pojedinim spravama. Koeficijent *partial eta squared* (η^2) je korišten za određivanje veličine efekta razlika među spravama. Pogreška prve vrste je postavljena na 5%.

REZULTATI

Rezultati deskriptivne statistike prosječnih ocjena na svakoj spravi, iz kolegija Sportske gimnastike 1 (SG1) i Sportske gimnastike 2 (SG2) te post hoc analize ANOVA-e uz korištenje Bonferroni korekcije za ponovljena mjerenja prikazani su u tablici 1.

Tablica 1. Deskriptivni statistički parametri prosječnih ocjena na spravi i rezultati t-testa za nezavisne uzorke (N=80)

		F=15,970; p=0,000; $\eta^2=0,168$						
	SPRAVA	AS±SD	MIN	MAX	SKEW	KURT	K-S	p
SG1	PRESKOK (1)	4,13±0,57	2,58	5,00	-0,53	-0,53	p < ,15	2, 4
	DVOVISINSKE RUČE (2)	3,86±0,71	2,00	5,00	-0,82	1,90	p > ,20	1, 3, 4, 5
	GREDA (3)	4,21±0,49	3,25	5,00	-0,11	-0,92	p > ,20	2
	TLO (4)	4,33±0,51	3,09	5,00	-0,89	0,09	p < ,10	1, 2
	KARIKE (5)	4,22±0,75	2,00	5,00	-2,11	6,63	p < ,05	2
		F=11,767; p=0,000; $\eta^2=0,236$						
SG2	PRESKOK (1)	3,88±0,63	2,50	5,00	-0,13	-0,52	p > ,20	4
	DVOVISINSKE RUČE (2)	4,08±0,57	2,89	5,00	-0,21	-0,88	p > ,20	4
	GREDA (3)	4,17±0,51	2,79	5,00	-0,68	-0,22	p > ,20	4
	TLO (4)	3,78±0,64	2,38	5,00	-0,05	-0,44	p > ,20	1, 2, 3, 5
	KARIKE (5)	4,23±0,60	2,00	5,00	-1,07	2,01	p > ,20	4

Legenda: AS±SD – aritmetička sredina±standardna devijacija, MIN – minimalna vrijednost, MAX – maksimalna vrijednost, Skew – mjera simetrije distribucije (Skewness), Kurt – mjera oblika distribucije (Kurtosis), K-S – Kolmogorov- Smirnovljevi test, p – značajnost razlika utvrđena post hoc analizom ANOVA-e korištenjem Bonferroni korekcije za ponovljena mjerenja, 1 – oznaka za preskok, 2 – oznaka za dvovisinske ruče, 3 – oznaka za gredu, 4 – oznaka za tlo, 5 – oznaka za karike

Iz rezultata SG1 je vidljiv raspon prosječnih rezultata na svim spravama od 3,86 (dvovisinske ruče) do 4,33 (tlo), odnosno kako studentice generalno znanja na svim spravama izvode za školsku ocjenu *vrlo dobar* (4) - s manjim tehničkim i/ili estetskim pogreškama (Delaš, 2005). Minimalna ocjena *dovoljan* (2), a koja predstavlja izvedbe s velikim tehničkim i/ili estetskim pogreškama, utvrđena je na dvovisinskim ručama i karikama, dok je na ostalim spravama minimalna ocjena bila ekvivalentna ocjeni *dobro* (3) – izvedbe sa srednjim tehničkim i/ili estetskim pogreškama. Na svim spravama utvrđena je maksimalna ocjena *odličan* (5), odnosno postojanje studentica koje su generalno, znanja na pojedinoj spravi, mogle izvoditi bez ikakvih tehničkih i/ili estetskih pogrešaka.

Rezultatima utvrđenim kod svih znanja, prema rezultatima K-S testa, utvrđeno je statistički značajno odstupanje od normalne distribucije. Pregledom vrijednosti Skew i Kurt vidljivo je da se radi o homogeniziranim ili manje homogeniziranim grupama rezultata koji su generalno negativno asimetrični odnosno tendiraju prema rezultatima višim od prosječne vrijednosti. Najviše vrijednosti navedenih parametara utvrđene su kod karika što navodi na zaljučak kako su, u odnosu na ostale sprave, elementi na ovoj spravi studenticama generalno najlakši za izvesti.

Iz tablice 1 možemo uočiti da su identificirane značajne razlike među spravama ($p=0,000$; $\eta^2=0,168$) odnosno da vježbanje na svim spravama nije jednako teško studenticama. Prema vrijednosti prosječne ocjene moglo bi se zaključiti kako im je najlakše bilo vježbati na tlu ($AS=4,33$), a najteže na dvovisinskim ručama ($AS=3,86$). Ovu konstataciju nadalje potvrđuju i rezultati post hoc analize koja je utvrdila značajno razlikovanje prosječnih ocjena na svim spravama s prosječnom ocjenom na dvovisinskim ručama.

Iz rezultata SG2 vidljiv je raspon prosječnih rezultata od 3,78 (tlo) do 4,23 (karike). Obje vrijednosti generalno predstavljaju školsku ocjenu *vrlo dobar* (4) odnosno izvedbe s manjim tehničkim i/ili estetskim pogreškama (Delaš, 2005). Minimalna ocjena *dovoljan* (2), koja predstavlja izvedbe s velikim tehničkim i/ili estetskim pogreškama, utvrđena je na tlu i karikama, dok je na ostalim spravama minimalna ocjena bila ekvivalentna ocjeni *dobro* (3) – izvedbi sa srednjim tehničkim i/ili estetskim pogreškama. Na svim spravama utvrđena je maksimalna ocjena *odličan* (5), odnosno postojanje studentica koje su generalno znanja na pojedinoj spravi mogle izvoditi bez ikakvih tehničkih i/ili estetskih pogrešaka.

Kao i kod rezultata iz SG1, prema rezultatima K-S testa, utvrđeno je statistički značajno odstupanje od normalne distribucije svih rezultata na

svim spravama iz SG2. Budući da se radi o generalno negativno asimetričnim distribucijama rezultata, odnosno distribucijama čiji rezultati tendiraju prema rezultatima višim od prosječne vrijednosti, možemo zaključiti da elementi na svim spravama studenticama generalno nisu preteški za položiti.

Prema rezultatima post hoc analize ($p=0,000$; $\eta^2=0,236$), kao i kod SG1, utvrđeno je da vježbanje na svim spravama nije jednako teško studenticama. Prema vrijednost prosječne ocjene moglo bi se zaključiti kako im je najlakše bilo vježbati na karikama ($AS=4,23$), a najteže na tlu ($AS=3,78$). Ovu konstataciju nadalje potvrđuju i rezultati post hoc analize koja je utvrdila značajno razlikovanje prosječnih ocjena sa svih sprava s prosječnom ocjenom na tlu.

Uvidom u rezultate ($\eta^2_{SG1} < \eta^2_{SG2}$) moguće je ustanoviti da unutar sprava na kolegiju SG2 postoje veće varijacije nego na kolegiju SG1 (Tablica 1).

ZAKLJUČAK

Sumirajući rezultate vidljivo je kako studentice na oba kolegija (SG1 i SG2) generalno vježbaju s manjim tehničkim i/ili estetskim pogreškama, odnosno za ocjenu *vrlo dobar* – 4. Kod većine znanja oba kolegija utvrđena su odstupanja od normalne distribucije rezultata, posljedično zbog većeg broja studentica koje znanja izvode bolje od prosječne ocjene. Na dvovisinskim ručama i karikama u SG1, odnosno na tlu i karikama u SG2 utvrđeno je da postoje studentice koje su neka znanja izvodile s velikim tehničkim i/ili estetskim pogreškama (za ocjenu *dovoljan* - 2). Radi se o spravama, odnosno znanjima, za čiju je izvedbu primarno potrebna snaga ruku i ramenog pojasa. Budući da je ova sposobnost, prema saznanjima autora, kod studentica najčešće manje izražena, i što otežava izvedbu istih, za dobiveni rezultat možemo reći da je dijelom bio i očekivan. Unutar kolegija SG1 višu razinu ove motoričke sposobnosti zahtijeva jedna sprava, a unutar SG2 tri sprave. Uvažavajući prethodno, veća varijabilnost među spravama u SG2 u odnosu na SG1 je logična posljedica. Zahtjevanost za višom razinom ove motoričke sposobnosti uzorkovalo je i međusobno razlikovanje među spravama u pojedinim kolegijima.

Iako su znanja koja zahtijevaju višu razinu snage ruku i ramenog pojasa utvrđena kao teža studenticama, autori su mišljenja da ista ne smiju biti eliminirana iz programa. Upravo suprotno. Kako bi se u budućnosti postigla viša razina usvojenosti tih znanja trebalo bi pri izradi izvedbenih planova obaju kolegija obvezno uvrstiti određene operatore za razvoj navedene motoričke sposobnosti.

Zaključno se može ustvrditi kako je dobivenim rezultatima potvrđena dobra prilagođenost programa oba kolegija populaciji studentica te da sukladno utvrđenoj razini usvojenosti gimnastičkih znanja postoji velika vjerojatnost za nezaboravljanjem istih. Autori se nadaju da će isto biti poticaj provedbe gimnastičkih znanja u praksi.

LITERATURA

Delaš Kalinski, S. (2009). Dinamika procesa učenja motoričkih znanja iz sportske gimnastike [Doktorska disertacija]. Zagreb: Kineziološki fakultet Sveučilišta u Zagrebu.

Delaš, S. (2005). Relacije između nekih morfoloških karakteristika, motoričkih sposobnosti i stupnja usvojenosti motoričkih struktura iz sportske gimnastike u 6. razredu osnovne škole. [Magistarski rad]. Zagreb: Kineziološki fakultet Sveučilišta u Zagrebu.

Erceg, T. (2010). Transfer znanja u sportskoj gimnastici. [Završni rad]. Kineziološki fakultet Sveučilišta u Splitu.

Hraski, Ž., Pedišić, Ž., & Vunić, M. (2004). Gimnastička anamneza studenata druge godine Kineziološkog fakulteta. U: K. Delija (ur.). Zbornik radova 13. ljetne škole pedagoga fizičke kulture Republike Hrvatske. Rovinj: Hrvatski savez pedagoga fizičke kulture.

Schmidt, R.A. & Lee, T.D. (2005). *Motor control and learning*. Champaign, IL. Human Kinetics.

Wolf – Cvitak, J. (1999). Zašto gimnastički sport nestaje u školama. U: K. Delija (ur.). Zbornik radova 8. ljetne škole pedagoga fizičke kulture Republike Hrvatske (str. 120-123). Rovinj: Hrvatski savez pedagoga fizičke kulture

Random Number Generator Comparisons of Effect Size Measures in One-Way Repeated Measures ANOVA

Igor Jelaska

Faculty of Kinesiology, University of Split, Croatia

ABSTRACT

Goal of this research is to discuss practical and theoretical issues of different effect sizes parameters together with theoretical background of One-Way Repeated Measures ANOVA. In accordance with a goal, random number generator was applied for simulation of $N_1=500$, $N_2=350$, $N_3=200$, $N_4=150$, and $N_5=100$ subject's and $k=3, 4$, and 5 repeated measurements. Effect size parameters eta squared (η^2), epsilon squared (ϵ^2), and omega squared (ω^2) were calculated, compared and discussed. Furthermore, effect size is discussed as „unit independent“ measure of how much variability of dependent variable is due to treatment or different experimental conditions effect, as parameter in power analysis while determining the sample size for future studies and finally as parameter which allows meta-analytic conclusions by comparing effect sizes across similar studies. Results and theoretical background clearly indicate that in applied sciences, it is necessary to report effect sizes as a measure of practical significance in designs concerning differences repeated measures or groups simply because values of statistical tests can be significant when the mean differences are so small that they do not have or have very small practical value.

Key words: methodology, practical significance, meta-analysis, variance decomposition

INTRODUCTION

When research involves comparisons of the same subjects during multiple observations over time (i.e. different time points) and/or different experimental conditions, that is refer as within-subjects research design (Tabachnick & Fidell, 2001). In order to detect significant differences in means trough different

measurement points, as statistical tool within-subjects or Repeated Measures (RM) ANOVA is usually used. To be of different scope from dependent samples t -test, experimental design must include at least one RM factor with at least three levels. Factor is considered as independent variable or predictor while measured variable as dependent or criterion. First assumption of RM ANOVA is normal distribution of dependent variable in the population for each level of the within subject factor (Tabachnick & Fidell, 2001). It is important to note that RM ANOVA is robust to violations of normality. More precisely, with a moderate ($n > 30$) or large sample sizes the test may still yield accurate values of significance (p) even if the normality assumption is violated except in thick tailed and heavily skewed distributions (Tabachnick & Fidell, 2006). Although RM ANOVA is robust to most violations of its assumptions, the assumption of sphericity is an exception. It is known that that its violation leads to increase in the Type I error rate. Unfortunately, this assumption is not usually satisfied in practice. In order to detect violation of sphericity assumption, Mauchly's test is applied via testing the hypothesis H_0 that the error covariance matrix of the orthonormalized transformed dependent variables is proportional to an identity matrix. If H_0 hypothesis is rejected, data together with degrees of freedom supposed to be Greenhouse-Geisser corrected. The Friedman ANOVA is a nonparametric alternative to one way RM ANOVA if assumptions are roughly violated. When using the Friedman test it is important to use a sample size of at least 12 participants to obtain accurate p values.

Theoretical background for One-Way RM ANOVA

Let us assume that from infinite and population n subjects have been randomly chosen and were measured in dependent and normally distributed variable X trough k different time points (or under k different conditions). Furthermore, with $x_{l,m}$ result of l^{th} subject during m^{th} measurement is noted. Consequently, obtained data can be presented as follows:

$$\begin{aligned} \text{1st measurement: } & x_{1,1}, x_{2,1}, \dots, x_{n,1} \\ \text{2nd measurement: } & x_{1,2}, x_{2,2}, \dots, x_{n,2} \\ & \vdots \\ \text{kth measurement: } & x_{1,k}, x_{2,k}, \dots, x_{n,k} \end{aligned}$$

Usually measurements are presented as columns in data matrices. It is obvious that all together there are $n \cdot k$ data.

Research hypotheses for One-Way RM ANOVA usually are:

$$H_0 : \mu_1 = \mu_2 = \dots = \mu_k$$

$$H_1 : \mu_i \neq \mu_j \text{ for some } i, j$$

Hypothesis (H_0) is pointing to the situation where no statistically significant differences amongst means of measurements during time appear. Contrary, if H_0 is rejected, one should suppose that differences among measurements during time exists, at least between i^{th} and j^{th} time point, for some $i, j=1, \dots, k$.

As in most parametric methods, logic behind RM ANOVA is data variability decomposition. Total variability in such design is sum of between-time or between-conditions or "effect" (SS_B or SS_{Time}) and within-subject variability (SS_W):

$$SS_T = SS_B + SS_W,$$

and within-subject variability (SS_W) can be decomposed as sum of intraindividual variability (SS_{Sub}) and error variability (SS_{Err}),

$$SS_W = SS_{Sub} + SS_{Err} \text{ and consequently}$$

$$SS_{Err} = SS_W - SS_{Sub}$$

Term "effect" is used due to the fact that identification and explanation of differences between measurements over time is main research problem. Similarly, term "error" does not mean mistake, it simply points to the possibility that variance can occur by chance alone or the variance that is unaccounted for by the effects of individual's differences during time.

Finally, decomposition of variability is obtained:

$$SS_T = SS_B + SS_{Sub} + SS_{Err}.$$

From calculation point of view, total mean (\bar{x}_T), means of measurements in time points \bar{x}_j , $j = 1, \dots, k$, and means of each subject's measurements during time \bar{x}_i , $i = 1, \dots, n$ have to be calculated:

$$\bar{x}_T = \frac{\sum_{j=1}^k \sum_{i=1}^n x_{i,j}}{n \cdot k} \quad ; \quad \bar{x}_j = \frac{\sum_{i=1}^n x_{i,j}}{n} \quad ; \quad \bar{x}_i = \frac{\sum_{j=1}^k x_{i,j}}{k},$$

Next, sums of squares: total (SS_T), between-time (SS_B), subjects (SS_{Sub}) and error (SS_{Err}) are calculated

$$SS_T = \sum_{j=1}^k \sum_{i=1}^n (x_T - x_{i,j})^2$$

$$SS_B = SS_{Time} = \sum_{j=1}^k \sum_{i=1}^n (x_T - \bar{x}_j)^2 = \sum_{j=1}^k n(x_T - \bar{x}_j)^2 = n \sum_{j=1}^k (x_T - \bar{x}_j)^2$$

$$SS_W = \sum_{j=1}^k \sum_{i=1}^n (\bar{x}_j - x_{i,j})^2$$

$$SS_{Sub} = \sum_{j=1}^k \sum_{i=1}^n (x_T - \bar{x}_i)^2 = \sum_{i=1}^n k(x_T - \bar{x}_i)^2 = k \sum_{i=1}^n (x_T - \bar{x}_i)^2$$

Taking into account that mean squares (MS) are computed if each sum of squares is divided by appropriate degrees of freedom following is obtained:

$$MS_T = \frac{SS_T}{df_T} = \frac{SS_T}{nk - 1}$$

$$MS_B = \frac{SS_B}{df_B} = \frac{SS_B}{k - 1}$$

$$MS_{Sub} = \frac{SS_{Sub}}{df_{Sub}} = \frac{SS_{Sub}}{n - 1}$$

$$MS_{Err} = \frac{SS_{Err}}{df_{Err}} = \frac{SS_{Err}}{(k - 1)(n - 1)}$$

and finally *F* value can be calculated

$$F(df_B, df_{Err}) = \frac{MS_B}{MS_{Err}}$$

Those data are usually reported in so called ANOVA table as presented in table 1.

Table 1: RM ANOVA table

Source of variation	SS	df	MS	F	p
Between time points/conditions (effect)	SS _B	k-1	MS _B	F	p
Error	SS _{Err}	(k-1)(n-1)	MS _{Err}		
Within subjects	SS _{Sub}	n-1			
Total	SS _T	nk-1			

In dependence of df_B and df_{Err} together with *Type I error* (α) critical F value is calculated. Equivalently, empirical significance p is calculated and if $p < \alpha$ hypothesis H_0 is rejected. Fundamental difference in calculation logic between within-subjects ANOVA and between-subjects ANOVA is that the within subject variability from repeated measures is adjusted for variability from subject to subject to obtain error variability SS_{Err} . More simply, SS_{Err} is adjusted for the within-subjects dependency of the measures.

Due to detection of time points where significant differences occurred, question can be asked: "If subjects were measured at k time points, why should

not we make $\binom{k}{2} = \frac{k(k-1)}{2}$ dependent samples t-tests?" Simply, if we use

multiple t-tests we provide greater probability of making *Type I error*. Also, t-test does not make use of all available information about population from which samples are drawn – simply only two samples are used for calculations in each step. More precisely, it can be shown (Keppel, 1991) that error while making family of comparisons (familywise error rate; FW_α), comparison error rate (α), number of comparisons to be made (c) are connected through following formula

$$FW_\alpha = 1 - (1 - \alpha)^c$$

For example, if $\alpha=0.05$, $k=5$ than $c=10$ and $FW_\alpha = 1 - 0.60 = 0.40$ which is 8 times bigger than α .

When significant F value is identified, post-hoc analysis can be applied to identify differences between particular measurements. Among others, there are: Least significant differences (LSD), Tukey honest significant difference (HSD), Scheffé, Bonferroni correction, Tukey-Kramer, Brown-Forsythe, Duncans multiple range, Newman Keuls, Fisher and others post hoc approaches. One of most used and also one of the most conservative (in the sense of rejecting H_0) together with Bonferroni is Scheffé. For example, Scheffé's F value for post hoc differences between i^{th} and j^{th} measurement is calculated by formula

$$F_{SHF} = \frac{(\bar{x}_i - \bar{x}_j)^2}{MS_{Err} (k-1) \left(\frac{1}{n_1} + \frac{1}{n_2} \right)}$$

Effect Sizes in RM ANOVA

Significant F value is not only factor which have to be considered while evaluating importance of the research finding. Why? When number of subjects (N) is large enough, and/or calculated MS_{Err} is small enough, F value will be significant when the mean differences are so small that they do not have or have very small practical value (Thompson, 2007; Tabachnick, & Fidell, 2006; Sullivan, & Feinn, 2012). As a measure of practical significance researcher should also report and discuss *size of the effect* or *effect size* of the differences or treatment in all ANOVA's particularly various within-subjects designs (Olejnik, & Algina, 2000; Cumming, 2012). Lakens (2013) state that „...effect sizes are the most important outcome of empirical studies“. There are several important aspects of effect size. Most important aspect of effect size is that it is generally accepted as a measure how much variability of dependent variable can be due to treatment or different experimental conditions effect (Borenstein, 2009; Elis, 2010; Rosenthal, 1994). Also effect size is „unit independent“ so it can be understood regardless of the scale that was used to measure the criterion variable (Maxwell, & Delaney, 2004).

Second, effect sizes can be used as parameter in power analysis while determining the sample size for future studies (Aberson, 2010). As it is well known, statistical power depends on the sample size of the study, effect size, and the Type I error. If three of above mentioned parameters are approximately known, the fourth parameter can be relatively precisely calculated. Usually in an a-priori power analysis, the sample size is calculated needed to obtain an effect of a specific size, with a pre-determined significance criterion, and a desired statistical power (Lakens, 2013).

Third, effect sizes allow researchers to draw meta-analytic conclusions by comparing standardized effect sizes across studies (Borenstein, 2011). Meta-analyses can provide more accurate effect size estimates for power analysis, and correctly reporting effect size estimates can facilitate future meta-analys. Researches also points to the fact that meta-analysis could generate overestimation of the true effect size (Lane, & Dunlap, 1978; Brand, et al., 2008; Bakker, van Dijk, & Wicherts, 2012) especially for repeated measures designs (Olejnik, & Algina, 2003).

Size effect gives us measure of group's comparison or treatment efficiency relatively independent of sample size. From the other point of view, it measures variance proportion of dependent variable that is explained by group differences or treatment. Historically, the magnitude of differences effect can

be reported in three ways: eta squared (η^2) (Pearson, 1905), epsilon squared (ϵ^2) (Kelley, 1935), and omega squared (ω^2) (Hays, 1963):

$$\eta^2 = \frac{SS_{EFF}}{SS_T}$$

$$\epsilon^2 = \frac{SS_{EFF} - (k-1)MS_{Err}}{SS_T}$$

$$\omega^2 = \frac{SS_{EFF} - (k-1)MS_{Err}}{SS_T + MS_{Err}}$$

It is obvious that $\eta^2 > \epsilon^2 > \omega^2$. In particular, ϵ^2 is adjustment of η^2 that reduces effect for $(k-1)MS_{Err}$ and ω^2 is adjustment of ϵ^2 that additionally reduces it by adding MS_{Err} to denominator. None of the parameters shown above is unbiased, although ω^2 is closest to that goal. As it can be seen some of the parameters can be less than 0, and in that case result is usually interpreted as exact 0. Empirically, for ω^2 value of .010 points to the small, .059 medium and .138 large effect size while for η^2 value of .02 points to the small, .13 medium and .26 large effect size (Kirk, 1996).

Goal of this research is empirical comparison of different effect sizes parameters in One Way RM ANOVA via randomly generated data. It is expected that randomly generated data will have large inter-subject variability and relatively small between-time variability. Consequently, it is expected that effect size parameters have small value. Calculated effect size values can be treated as expected values for different effect sizes parameters when repeated measures data have large inter-subject and small between-time variability.

METHODS

By using Statistica 12.6. (StatSoft, Tulsa, USA) random number generator was applied for simulation of $N_1=500$, $N_2=350$, $N_3=200$, $N_4=150$, and $N_5=100$ subject's and $k=3, 4$, and 5 repeated measurements. Obtained data were greater than 0 and less than 100. Mean square error (MS_{Err}), F value (F), significance level (p), eta squared (η^2), epsilon squared (ϵ^2), and omega squared (ω^2) were calculated by using previously shown formulas.

RESULTS AND DISCUSSION

In table 2, results of effect sizes for $N_1=500$, $N_2=350$, $N_3=200$, $N_4=150$, and $N_5=100$ randomly generated subject's results and $k=3, 4$, and 5 repeated measurements are presented.

Table 2: Effect sizes for $N_1=500$, $N_2=350$, $N_3=200$, $N_4=150$, and $N_5=100$ randomly generated subject's results and $k=3, 4$, and 5. Mean square error (MS_{Err}), F value (F), significance level (p), eta squared (η^2), epsilon squared (ϵ^2), and omega squared (ω^2).

N_i	N	MS_{Err}	F	P	η^2	ϵ^2	ω^2
500	3	0,080	0,071	0,071	0,005	0,002	0,002
	4	0,083	0,420	0,420	0,002	0,000	0,000
	5	0,087	0,264	0,264	0,003	0,001	0,001
350	3	0,088	3,137	0,044	0,009	0,004	0,004
	4	0,081	0,112	0,953	0,000	-0,002	-0,002
	5	0,081	0,424	0,791	0,001	-0,001	-0,001
200	3	0,080	0,356	0,700	0,002	-0,002	-0,002
	4	0,082	0,714	0,544	0,004	-0,001	-0,001
	5	0,082	0,714	0,544	0,004	-0,002	-0,002
150	3	0,087	1,795	0,168	0,012	0,004	0,004
	4	0,082	0,384	0,764	0,003	-0,003	-0,003
	5	0,087	0,718	0,580	0,005	-0,002	-0,002
100	3	0,081	0,138	0,871	0,001	-0,006	-0,006
	4	0,089	0,467	0,706	0,005	-0,004	-0,004
	5	0,079	0,956	0,431	0,010	0,000	0,000

From table 2 it can be seen that variation in F value is relatively large, and p level is not significant except once ($p=0.044$). Furthermore, it can be seen that ω^2 have same values as ϵ^2 what is obviously consequence of relatively small MS_{Err} comparing to SS_T . Also, with increase of time points, effect size measures are decreasing, independently of sample size. Also it must be noted that MS_{Err} have almost constant values trough all measurements (0.079-0.089). As expected inequality $\eta^2 > \epsilon^2 > \omega^2$ holds for all situations. Observing results from point of p values, systematic behavior cannot be detected in relation to number of measurements. It can be noted that all effect sizes are small.

CONCLUSION

In this research, theoretical background of One-Way RM ANOVA was provided and practical issues due to effect sizes are clarified. In applied sciences, it is necessary to report effect sizes as a measure of practical significance in designs concerning differences among groups or repeated measures simply because values of statistical tests can be significant when the mean differences are so small that they do not have or have very small or trivial practical value. When using RM ANOVA effect size can be reported in three ways: eta squared (η^2), epsilon squared (ϵ^2), and omega squared (ω^2). Although not unbiased parameter, most standard in use is (partial) η^2 due to its implementation in *SPSS* and *Statistica*. Researcher also has to be aware of those limitations of effect sizes parameters. Most important aspect of effect size is that it is „unit independent“ measure of how much variability of dependent variable can be due to treatment or different experimental conditions effect. Also, effect sizes can be used as parameter in power analysis while determining the sample size for future studies and also allow researchers to bring meta-analytic conclusions by comparing effect sizes across similar studies.

REFERENCES

- Aberson, C.L. (2010). *Applied Power Analysis for the Behavioral Sciences*. New York: Routledge.
- Bakker, M., van Dijk, A., & Wicherts, J.M. (2012). The rules of the game called psychological science. *Perspectives on Psychological Science* 7, 543–554.
- Bakeman, R. (2005). Recommended effect size statistics for repeated measures designs. *Behavioral Research Methods* 37, 379–384.
- Borenstein, M. (2009). Effect sizes for continuous data. In H. Cooper, L. V. Hedges, & J. C. Valentine (Eds.), *The handbook of research synthesis and meta analysis* (pp. 221-237). New York: Russell Sage Foundation.
- Borenstein, M., Hedges, L.V., Higgins, J.P., & Rothstein, H.R. (2011). *Introduction to Meta-Analysis*. Hoboken, NJ: Wiley.
- Brand, A., Bradley, M.T., Best, L.A., & Stoica, G. (2008). Accuracy of effect size estimates from published psychological research. *Perceptual and Motor Skills* 106, 645–649.
- Cumming, G. (2012). *Understanding the New Statistics: Effect sizes, Confidence Intervals, and Meta-Analysis*. New York, NY: Routledge.

Elis, P. (2010). *The Essential Guide to Effect Sizes: Statistical Power, Meta-Analysis, and the Interpretation of Research Results*. Cambridge: Cambridge University Press.

Hays, W.L. (1963). *Statistics for psychologists*. New York: Holt, Rinehart & Winston.

Kirk, R.E. (1996). Practical significance: A concept whose time has come. *Educational and Psychological Measurement* 56(5), 746-759.

Kelley, T.L. (1935). An unbiased correlation ratio measure. *Proceedings of the National Academy of Sciences* 21, 554-559.

Lakens, D. (2013). Calculating and reporting effect sizes to facilitate cumulative science: a practical primer for t-tests and ANOVAs. *Frontiers in Psychology* 4, 863.

Lane, D.M., & Dunlap, W.P. (1978). Estimating effect size: bias resulting from the significance criterion in editorial decisions. *British Journal of Mathematical and Statistical Psychology* 31, 107-112.

Olejnik, S., & Algina J. (2000). Measures of effect size for comparative studies: applications, interpretations, and limitations. *Contemporary Educational Psychology* 25, 241-286.

Olejnik, S., & Algina J. (2003). Generalized eta and omega squared statistics: measures of effect size for some common research designs. *Psychological Methods* 8, 434-447.

Pearson, K. (1905). Mathematical contributions to the theory of evolution: XIV. On the general theory of skew correlations and nonlinear regression (Draper's Company Research Memoirs, Biometric Series II). London: Dulau.

Rosenthal, R. (1994). Parametric measures of effect size. In H. Cooper & L. V. Hedges (Eds.), *The Handbook of Research Synthesis* (231-244). New York, NY: Sage.

Rosenthal, R. & DiMatteo, M.R. (2001). Meta-Analysis: Recent Developments in Quantitative Methods for Literature Reviews. *Annual Review of Psychology* 52(1), 59-82.

Sullivan, G.M., & Feinn, R. (2012). Using Effect Size - or Why the P Value Is Not Enough, *Journal of Graduate Medical Education* 4(3), 279-282.

Tabachnick, B.G., & Fidell, L.S. (2006). *Experimental design Using ANOVA*. Belmont, CA: Duxbury.

Tabachnick, B.G., & Fidell, L.S. (2001). *Using Multivariate Statistics*, 4th Ed. Boston: Allyn and Bacon.

Thompson, B. (2007). Effect sizes, confidence intervals, and confidence intervals for effect sizes. *Psychology in the Schools* 44, 423-432.

Morfološki i motorički prediktori agilnosti kod dječaka

Miodrag Spasić, Karlo Gašpar, Antonio Perić

Kineziološki fakultet, Sveučilište u Splitu, Hrvatska

ABSTRACT

The main objectives of the research were to define the influence of morphological characteristics and some motor skills (individual measures of explosive strength, speed, balance and flexibility) on the results of agility tests of boys in puberty. The sample consisted of 73 boys aged 13-14 years that are not actively involved in sports or are engaged in sports whose movement structures differ substantially from the movements that were used during the execution of selected tests of agility. We notice a very logical and partly expected impact of predictors on the criterion variable, which is directly, related to biomechanics and kinesiology features of individual agile movement structures contained in the tests.

Key words: morphology, motor skills, agility predictors, puberty

Uvod

Postoje različite definicije i pogledi na agilnost, od kratkih i općenitih do opsežnih i kompleksnih (Sheppard i Young, 2006), ali svima je zajedničko da se agilnost vezuje uz brzu i uspješnu promjenu pravca kretanja. Sekulić i Metikoš (Sekulić i Metikoš, 2007) daju jednostavniju definiciju agilnosti: sposobnost efikasne promjene pravca i/ili smjera kretanja. Serpell i sur. (Serpell i sur., 2010) navode da u zadnje vrijeme postoje prepirke kako agilnost ne zahtijeva samo sposobnost brze promjene smjera kretanja već i neke perceptualne vještine.

Pretragom znanstvene literature uočeno je da su u istraživanjima provedenima kod nas i u svijetu, autori do sada većinom istraživali utjecaj snage i brzine na manifestaciju agilnost (Young i sur., 1996; Šalaj i Marković,

2011). Autori ovog rada smatrali su kako bi trebalo potražiti i druge čimbenike koji određuju agilnost jer su brojna istraživanja dokazala kako su snaga i brzina njeni relativno slabi prediktori (Marković i sur., 2007; Nimphius i sur., 2010). U svom su istraživanju Metikoš i suradnici (Metikoš i sur., 2003) utvrdili kako postoji i veliki broj manifestacija agilnosti, ali zajednički problem svih dosadašnjih istraživanja na temu agilnosti autori ove studije vide u činjenici da su ispitanici uvijek bili na neki način selektirani (studenti kineziologije ili sportaši). Cilj ovog istraživanja bio je definirati utjecaj morfoloških osobina i nekih motoričkih sposobnosti (mjera eksplozivne snage, brzine, ravnoteže i fleksibilnosti) na rezultate u testovima agilnosti kod dječaka u pubertetu. Kako bi se izbjeglo da već usvojene agilne kretnje daju krivu sliku o stvarnom utjecaju prediktora na kriterij, u ovom radu korišten je uzorak ispitanika za koje se smatralo da nisu usvojili agilne kretnje potrebne za izvedbu korištenih testova agilnosti (kriterijskih varijabli).

METODE

Istraživanje je provedeno u Splitu, tijekom zimskog i proljetnog perioda školske 2011/12 godine. Ispitanici su najprije selektirani s obzirom na ideju da se u istraživanje uključilo samo one koji se ne bave sportovima u kojima postoji naglašena potreba za agilnošću (košarka, nogomet, rukomet, tenis), a kako bi se izbjegao utjecaj tehnike izvedbe i jasnije definirao utjecaj motoričkih i morfoloških varijabli na manifestaciju agilnosti. Uzorak ispitanika su sačinjavala 73 dječaka, dobi 13-14 godina koji se nisu aktivno bavili sportom ili su se bavili sportovima čije se kretne strukture bitno razlikuju od kretnji koje su korištene prilikom izvođenja odabranih testova agilnosti. Na ovaj način pokušalo se u određenoj mjeri anulirati utjecaj tehnike izvedbe testova na konačni rezultat u varijablama agilnosti. Uzorak ispitanika odabran je s ciljem da se analiziraju ispitanici kod kojih nije došlo do znatnijeg razvoja tehnike izvođenja agilnih kretnih struktura, a koja bi mogla u određenoj mjeri izravno utjecati na rezultat u testovima agilnosti.

Ukupan uzorak varijabli može se podijeliti u dva seta varijabli: set prediktorskih varijabli i set kriterijskih varijabli. Prediktorske varijable uključivale su motoričke varijable (skok u dalj s mjesta, skok u vis s mjesta, bočni preskoci, sprint na 5 metara, sprint na 10 metara, sprint na 15 metara, everzija stopala, inverzija stopala, dorzalna fleksija, plantarna fleksija, "limits of stability", "overall stability indeks") i varijable morfološkog statusa (tjelesna visina, tjelesna masa, duljina noge, sjedeća visina, postotak tjelesne masti, indeks tjelesne mase, bezmasna masa tijela). Set kriterijskih varijabli sačinjavale su varijable agilnosti (T-test i cik-cak test). Spasić (2013) daje detaljan opis varijabli kao i način izvođenja primijenjenih testova.

Povezanosti među varijablama utvrđene su putem korelacijskih i multiplih regresijskih analiza uz izračunavanje: koeficijena korelacije, multiplih korelacijskih koeficijena, koeficijena determinacije i pripadajućih razina značajnosti. Korištena je forward stepwise regresijska analiza.

REZULTATI

Tablica 1: Linearne korelacije i multiple regresije (forward stepwise model) između seta prediktora i kriterijskih varijabli

(* označava koeficijente koji su značajni na 95%)

	MCC	MTT		MCC	MTT
	r	r		Beta	Beta
ATV	0.10	-0.05		1.19	0.14
ATT	0.28*	0.23		0.89	
ADN	-0.06	-0.11		-0.74*	
ASV	0.08	-0.10		-0.67	
SDM	-0.35*	-0.57*			
MSV	-0.36*	-0.46*			
MBP	-0.44*	-0.59*		-0.25	
S5M	0.45*	0.69*			
S10M	0.52*	0.81*		0.36*	0.52
S15M	0.50*	0.81*			0.41
EVERZIJA	0.14	-0.03			
INVERZIJA	0.07	-0.06			-0.12
DORZFLEX	0.06	-0.13		0.34*	
PLANTFLEX	0.10	0.02		0.33*	0.10
LOS	-0.14	-0.22			
OSI	0.35*	0.31*		-0.23	-0.19
BFAT	0.21	0.30*			
BMI	0.24	0.28*		-0.60	
LEAN	0.20	0.07			
R				0.69*	0.84*

LEGENDA: ATV – tjelesna visina; ATT – tjelesna masa; ADN – duljina noge; ASV – sjedeća visina; BFAT – postotak tjelesne masti; BMI – indeks tjelesne mase; LEAN – bezmasna masa tijela; SDM – skok u dalj s mjesta; MSV – skoku vis s mjesta; MBP – bočni preskoci; S5M – sprint na 5 metara; S10M – sprint na 10 metara; S15M – sprint na 15 metara; EVERZIJA – everzija stopala; INVERZIJA – inverzija stopala; DORZFLEX – dorzalna fleksija; PLANTFLEX – plantarna fleksija; LOS – „limits of stability“; OSI – „overall stability indeks“; MCC – cik-cak test; MTT – T test; r – koeficijent korelacije; Beta – standardizirani regresijski koeficijent; R – koeficijent multiple korelacije

Generalno se uočava kako su sa svim kriterijskim varijablama značajno povezane varijable eksplozivne i reaktivne snage, te brzine sprinta. Negativni koeficijenti korelacije između reaktivne i eksplozivne snage s varijablama agilnosti odražavaju obrnutu skaliranost varijabli. U osnovi radi se o pozitivnom utjecaju eksplozivne snage tipa skočnosti i brzine sprinta na manifestacije agilnosti. Kod varijable MTT javlja se značajna korelacija između OSI (ravnoteža) i manifestacije agilnosti, te negativan utjecaj masnog tkiva i povećanog BMI na ovu manifestaciju agilnosti. Sličan trend utjecaja javlja se i kod varijable MCC, samo što u ovom slučaju faktor negativnog utjecaja predstavlja veća tjelesna težina, neovisno o sastavu tijela

Linearna kombinacija prediktorskih varijabli definira 48% varijance kriterijske varijable MCC. Radi se o latentnoj strukturi koju determinira naglašena sposobnost brzine sprinta, izražena dužina donjih ekstremiteta, te neizražena fleksibilnost skočnog zgloba

Kod regresijske analize kojom se utvrđivala povezanost prediktora s MTT nema značajnih beta pondera premda je objašnjeno 70% varijance kriterija. Radi se o pozitivnom utjecaju brzine i medio-lateralne fleksibilnosti gležnja, uz negativan utjecaj ravnoteže, tjelesne visine i plantarne fleksije.

DISKUSIJA I ZAKLJUČCI

Univarijatne povezanosti između prediktorskih i kriterijskih varijabli ukazuju na činjenicu kako se radi o relativno homogenim povezanostima varijabli eksplozivne snage i brzine s mjerama agilnosti razmatranim u ovom radu. Osim generalnog pozitivnog utjecaja ovih sposobnosti s koeficijentima korelacije od 0.35 do 0.81 uočavaju se samo pojedine značajne korelacije relativno niskih koeficijenata od oko 0.3 koji se tiču povezanosti ravnoteže s testovima MCC i MTT. Navedeno je u skladu s dosadašnjim studijama koje su utvrdile značajne povezanosti između mjera brzine i eksplozivne snage s mjerama agilnosti na uzorcima treniranih sportaša (Marković i sur., 2007; Sekulić i sur., 2013). Zanimljivo, morfološke varijable su slabo univarijatno povezane s testovima agilnosti koji su razmatrani kao kriterijske varijable u ovom radu. S obzirom na moguću pojavu supresorskih efekata (međusobne povezanosti prediktorskih varijabli) puno više o samoj prirodi povezanosti se može reći kada se analiziraju multivarijatne povezanosti kroz regresijsku analizu.

U testu MCC objašnjen je relativno malen postotak varijance (48%). Radi se o pozitivnom utjecaju brzine trčanja, negativnom utjecaju dviju varijabli za

procjenu fleksibilnosti skočnog zgloba (PLANTFLEX i DORZFLEX), te u ovom slučaju pozitivnom utjecaju duljine noge. Kod ovog testa treba napomenuti kako se radi o jedinom od primijenjenih testova u kojem se za vrijeme cijelog testa zadržava pravocrtno gibanje tijelom prema naprijed što u stvari generira najveći parcijalni utjecaj brzine trčanja (Sekulić i sur., 2013), pa je stoga relativno visok utjecaj brzine na izvedbu testa i logičan. Fleksibilnost gležnja očito je sama po sebi problematična jer ovom fleksibilnošću u stvari dovodimo ispitanika u narušeni položaj ravnoteže što u ovom slučaju generira nešto lošiji rezultat. Kod testa MCC duljina noge ima pozitivan utjecaj na kriterij što je vrlo vjerojatno posljedica činjenice da duljina noge određuje duljinu koraka što je u ovom testu definitivno prednost s obzirom da se praktički put savladava uz male promjene pravca cik-cak kretanjem.

Kod varijable MTT objašnjen je relativno velik postotak varijance (70%) i ne uočava se niti jedan parcijalni utjecaj pa se generalno može govoriti o utjecaju brzine sprinta, ravnoteže i negativnom utjecaju izražene tjelesne visine na izvedbu ovog testa. Kao generalni zaključak dosadašnjih studija treba istaknuti činjenicu da je vrlo rijetko zabilježeno da su promatrani prediktori objasnili više od 50% ukupne varijance kriterija. Samo su u studijama napravljenim multivarijantnim pristupom zabilježeni postoci objašnjene varijance veći od 50% (Marković i sur., 2007; Sekulić i sur., 2013).

Ukupna količina objašnjene varijance u ovom istraživanju slična je kao kod svih dosadašnjih studija koje su se ovim problemom bavile, a koje su kao što je već rečeno istraživale trenirane uzorke ispitanika. Za relativno visoku količinu objašnjene varijance kod testa MTT mogla bi se istaknuti dva osnovna moguća razloga. Prvo: u ovom istraživanju odabran je uzorak ispitanika koji je homogen po pitanju kvalitete izvedbe agilnih kretnih struktura, točnije – niti jedan od ispitanika nema usvojenu tehniku izvedbe. Drugo: uzorak varijabli uključio je varijable koje nisu do sad istraživane kao prediktori agilnosti, kao što su: duljina noge, sjedeća visina, bočni preskoci, te varijable za procjenu ravnoteže i fleksibilnosti stopala. Kriterijski testovi agilnosti odabrani su zbog raznovrsnosti smjerova kretanja (ispitanik se kreće naprijed kontinuirano uz male promjene smjera kretanja - cik-cak test; ispitanik se mora zaustaviti kako bi promijenio smjer kretanja, kretati se bočno i unazad - T test), prema nalazima studije koju su proveli Metikoš i suradnici (Metikoš i sur., 2003).

Kao zaključak studije može se navesti da je način odabira uzorka ispitanika omogućio dobivanje jasnije slike utjecaja prediktora na kriterijske varijable što potvrđuje i količina objašnjene varijance u odnosu na dosadašnja istraživanja.

Dobiveni rezultati mogu pomoći prilikom vršenja selekcije dječaka na način da ih se usmjerava u sportove ovisno o manifestaciji agilnosti koja dominira u određenom sportu, a za koju su "predodređeni" sudeći po njihovim morfološkim osobinama i trenutnoj razini motoričkih sposobnosti.

LITERATURA

Marković, G., Sekulić, D., i Marković, M. (2007). Is agility related to strength qualities? - Analysis in latent space. *Coll Antropol*, 31(3), 787-793.

Metikos, D., Markovic, G., Prot, F., i Jukić, I. (2003). Latent structure of agility obtained by a battery of tests. *Kineziologija*, 35(1) 14-29.

Nimphius, S., Mcguigan, M. R., i Newton, R. U. (2010). Relationship between Strength, Power, Speed, and Change of Direction Performance of Female Softball Players. *Journal of Strength and Conditioning Research*, 24(4), 885-895.

Sekulić, D., i Metikoš, D. (2007). *Osnove transformacijskih postupaka u kineziologiji*: Sveučilište u Splitu, Fakultet PMZK.

Sekulić, D., Spasić, M., Mirkov, D., Čavar, M., i Sattler, T. (2013). Gender-specific influences of balance, speed, and power on agility performance. *Journal of Strength and Conditioning Research*, 27(3), 802-811.

Serpell, B. G., Ford, M., i Young, W. B. (2010). The Development of a New Test of Agility for Rugby League. *Journal of Strength and Conditioning Research*, 24(12), 3270-3277.

Sheppard, J. M., i Young, W. B. (2006). Agility literature review: Classifications, training and testing. *Journal of Sports Sciences*, 24(9), 919-932.

Spasić, M. (2013). Morfološki i biomotorički prediktori agilnosti u pubertetu. *Doktorska disertacija*.

Šalaj, S., i Marković, G. (2011). Specificity of Jumping, Sprinting, and Quick Change-of-Direction Motor Abilities. *Journal of Strength and Conditioning Research*, 25(5), 1249-1255.

Young, W.B., M. Hawken, L. McDonald (1996). Relationship between speed, agility, and strength qualities in Australian rules football. *Strength and Conditioning Coach*, 4(4), 3-6.

Usporedba antropološkog statusa učenika iz Zagreba i Dubrovnika

Mateja Kunješić¹, Marijana Hraski¹, Edita Skaramuca², Ivan Prskalo¹

¹Faculty of Teacher Education University of Zagreb, Croatia

²Elementary school Ivan Gundulić, Dubrovnik, Croatia

Abstract

The aim was to compare the anthropological status of students of primary education in Zagreb and Dubrovnik. The study included 85 students from Zagreb and 68 students from Dubrovnik with an average age of 8.37 ± 1.12 . All participants were measured for body height and body weight by which body mass index was calculated. Motor skills were tested by conventional tests used in school (polygon backwards, jump from the place, sit and reach on beam, sit-ups, hand tapping), while the functional abilities were tested by running 3'. Basic descriptive parameters were calculated for all the variables while the differences between Zagreb and Dubrovnik children were tested by Mann-Whitney U test. With the help of percentiles curve the nutritional status of students was determined. Significant differences were obtained in body height, body weight, polygon backwards, sit and reach on beam, the long jump with places and sit-ups, all to the benefit of children from Dubrovnik. It can be concluded that the children of Dubrovnik have a better anthropological status of children from Zagreb.

Keywords: motor abilities, functional abilities, nutrition, primary education students

UVOD

„Antropološka obilježja su organizirani sustavi svih osobina, sposobnosti i motoričkih informacija te njihove međusobne relacije. U antropološka obilježja spadaju morfološke značajke, motoričke, funkcionalne i kognitivne (spoznajne)

spособnosti, konativne osobine ili osobine ličnosti i socijalni status.“ (Prkalo, 2004, str. 88). Stoga je poznavanje antropološkog statusa pojedinca preduvjet za siguran, svrhovit i kvalitetan rad u kineziološkoj edukaciji (Mišigoj-Duraković i Duraković, 2007).

Za pravilan rast i razvoj, cijeli antropološki status djeteta mora biti u granicama preporučenih vrijednosti. Međutim, zbog današnjeg sedentarnog načina života i sve manje tjelesne aktivnosti (Rivera i sur., 2002) narušava se i antropološki status djece od sve ranije dobi. Prema podacima iz 2013. godine, u svijetu živi preko 42 milijuna prekomjerno teške ili pretile djece mlađe od 5 godina (WHO, 2014), čiji se broj iz dana u dan povećava. Zabrinjavajuća je činjenica da se pretilost u dječjoj dobi povezuje s morbiditetom i mortalitetom u odrasloj dobi (Nieto, Szklo i Comstock, 1992). Povećanjem sve većeg broja djece koja imaju problema s prekomjernom tjelesnom masom, dolazi do smanjena razine tjelesne aktivnosti (Dollman, Norton, K., Norton, L, 2005), a samim time i do smanjenja motoričkih sposobnosti djece (Hardy, King, Espinel, Cosgrove, Bauman, 2010). Osim toga, tjelesna aktivnost i motoričke sposobnosti djece mogu biti temelj uzajamnog i dinamičnog odnosa čiji su posrednici aerobni fitness i pretilost (Stodden, Langendorfer i Robertson, 2009). Osnovne motoričke sposobnosti sastoje se od lokomotornih sposobnosti (npr. trčanje, galopiranje, skakanje itd.) i sposobnosti kontroliranja objekata (npr. bacanje, hvatanje, koturanje itd.) (Stodden i sur., 2008). Te sposobnosti oblikuju temelje za buduće kretanje i tjelesne aktivnosti (Clark i Metcalfe, 2002, prema Stodden i sur., 2008).

Smanjenjem svakodnevne tjelesne aktivnosti, nastava tjelesne i zdravstvene treba biti mjesto na kojem će se djeci pružiti prilika za razvoj motoričkih sposobnosti koje će dovesti do povećanja preporučene tjelesne aktivnosti (Beurden i sur., 2003). Istraživanja su dokazala da neuspjeh u razvijanju i poboljšanju motoričkih sposobnosti tijekom predškolskog i školskog razdoblja, dovodi do oskudice i neuspjeha u svladavanju vještina u odrasloj dobi (Akbari i sur., 2009).

Stoga je cilj ovog istraživanja usporediti antropološki status učenika primarne edukacije iz Zagreba i Dubrovnika. Želi se utvrditi razlikuje li se antropološki status učenika koji nastavu Tjelesne i zdravstvene kulture provode pod nadzorom učitelja i profesora s fakulteta od učenika koji nastavu provode samo pod nadzorom učitelja.

METODE RADA

Uzorak ispitanika

Istraživanje je provedeno na 85 učenika iz osnovne škole Ivana Gorana Kovačića u Zagrebu i 68 učenika iz osnovne škole Marina Držića u Dubrovniku. Uzorak sudionika čine učenici primarne edukacije (prosječne dobi $8,37 \pm 1,12$).

Uzorak varijabli

Sudionicima istraživanja izmjerena je tjelesna visina i tjelesna masa pomoću kojih je izračunat indeks tjelesne mase (ITM) sudionika prema formuli TM/TV^2 (kg/m^2) (Garow i Webster, 1985). S obzirom na dob i spol, uz pomoć centilnih krivulja, sudionicima je određen stupanj uhranjenosti. Učenici do 5. centila svrstani su u grupu pothranjene djece, od 5. do 85. centila u grupu normalno uhranjene djece, od 85. do 95. centila u grupu prekomjerno teške djece te učenici preko 95. centila svrstani su u grupu pretilih (CDC, 2000).

Motoričke sposobnosti provjeravane su klasičnim testovima koji se koriste u kineziološkoj edukaciji. Koordinacija je provjeravana *poligonom natraške* (MPOL), fleksibilnost *pretklonom na klupici* (MPRK), brzina pokreta *tapingom rukom* (MTPR15), eksplozivna snaga *skokom u dalj s mjesta* (MSD), repetitivna snaga *podizanjem trupa* (MPT), dok su funkcionalne sposobnosti provjeravane testom *trčanje 3'* (F3).

Istraživanje je provedeno prema uputama Međunarodnog biološkog programa (International Biological Program-IBP), (Mišigoj-Duraković, 2008). Roditelji djece koja su sudjelovala u istraživanju svojim potpisom su dali dopuštenje da se na njihovom djetetu izvrši testiranje, a istraživanje je bilo provedeno u skladu s Etičkim kodeksom za istraživanja s djecom (Ajduković, Kolesarić, 2003).

Obrada podataka

Podaci su obrađeni uz pomoć programskog paketa Statsoft Statistica v7.0.61.0. Za sve varijable izračunati su osnovni deskriptivni parametri: aritmetička sredina i standardna devijacija. Razlike u morfološkim obilježjima, motoričkim i funkcionalnim sposobnostima testirane se Mann-Whitney U testom s obzirom da su neke varijable odstupale od normalne distribucije.

REZULTATI I DISKUSIJA

U Tablici 1 prikazani su deskriptivni pokazatelji učenika iz Zagreba i Dubrovnika. Iz podataka se vidi da su djeca iz Dubrovnika nešto viša i teža

od djece iz Zagreba. Isto tako, djeca iz Dubrovnika postigla su bolje rezultate u svim motoričkim testovima dok su djeca iz Zagreba postigla nešto bolje rezultate u testu F3' za provjeru funkcionalnih sposobnosti. I kod učenika iz Zagreba i kod učenika iz Dubrovnika dobivene su velike standardne devijacije u varijablama masa tijela, poligon natraške, pretklon na klupici, skok u dalj s mjesta, podizanje trupa i trčanje 3' što ukazuje na velika odstupanja rezultata od aritmetičke sredine u tim varijablama.

Djeca iz Dubrovnika nešto su viša (138 cm) i teža (35,21 kg) od djece iz Zagreba (134 cm / 33,39 kg). Usporede li se rezultati s rezultatima istraživanja Prebeg i Kern (1973) djeca iz obiju regija su i viša i teža, ali i dalje prate normalnu krivulju rasta i razvoja (Prebeg, 2002). Povećanje tjelesne visine djece u ovom istraživanju s obzirom na vršnjake iz 1973. je očekivano s obzirom da je sekularni trend povećanja visine od 1900. za 1-2 cm za svako desetljeće (Tanner, 1989).

Tablica 1 Deskriptivni pokazatelji učenika iz Zagreba i Dubrovnika

	A.S. ZG	A.S. DU	S.D. ZG	S.D. DU
LDV (m)	1,34	1,38	0,09	0,08
VMT (kg)	33,39	35,21	8,49	7,66
ITM	18,19	18,10	2,65	2,46
MPOL (sek)	27,31	21,95	11,67	6,07
MPRK (cm)	19,69	26,14	7,23	6,00
MTAP (sek)	22,17	21,51	3,32	3,37
MSD (cm)	129,03	146,00	22,19	23,07
MPT	28,92	33,91	8,89	7,58
F3' (m)	559,77	538,97	72,07	130,85

Legenda: LDV- tjelesna visina, VMT-tjelesna masa, ITM-indeks tjelesne mase, MPOL-poligon natraške, MPRK-pretklon na klupici, MITAP-taping rukom, MSD-skok u dalj s mjesta, MPT-podizanje trupa, F3-trčanje 3', AS ZG i SD ZG-aritmetičke sredine i standardne devijacije rezultata učenika iz Zagreba, AS DU i SD DU- aritmetičke sredine i standardne devijacije rezultata učenika iz Dubrovnika

U Tablici 2 prikazani su rezultati Mann-Whitney U testa učenika iz Zagreba i Dubrovnika. Učenici iz Dubrovnika značajno su viši i teži od učenika iz Zagreba. Zanimljivo je da usprkos tim značajnim razlikama, razlika u varijabli ITM nije statistički značajna. Isto tako dobivena je i značajna razlika u varijablama poligon natraške, pretklon na klupici, skok u dalj s mjesta i podizanje trupa, također u korist učenika iz Dubrovnika.

Tablica 2 Razlike u antropološkom statusu između učenika iz Zagreba i Dubrovnika dobivene Mann-Whitney U testom

	U	p
Visina tijela	2082,00	0,00*
Masa tijela	2321,00	0,03*
Indeks tjelesne mase	2833,50	0,83
Poligon natraške	2075,50	0,00*
Pretklon na klupici	1442,50	0,00*
Taping rukom	2594,50	0,27
Skok u dalj s mjesta	1531,00	0,00*
Podizanje trupa	1931,50	0,00*
Trčanje 3'	2748,50	0,60

U – vrijednost testa; p – pogreška; označene p vrijednosti su značajne ($p < ,05$)

U Tablici 3 prikazano je stanje uhranjenosti učenika u postocima, koje je zabrinjavajuće. Malo više od polovice sudionika iz oba grada spada u grupu normalno uhranjene djece, dok ostali sudionici pripadaju grupi prekomjerno teške, odnosno pretile djece. U oba grada je po 1 % pothranjene djece.

Tablica 3 Stanje uhranjenosti učenika iz Zagreba i Dubrovnika

	Postotak pothranjenih	Postotak normalno uhranjenih	Postotak prekomjerno teških	Postotak pretilih
Učenici iz Zagreba	1 %	52 %	29 %	18 %
Učenici iz Dubrovnika	1 %	53 %	26 %	18 %

Iako su mnogi autori dokazali da djeca normalne tjelesne mase imaju bolje motoričke sposobnosti (Hardy i sur., 2010) to se u ovom istraživanju nije dokazalo. Djeca iz Dubrovnika u većini motoričkih sposobnosti su postigla bolje rezultate, dok u ITM-u nisu dobivene statistički značajne razlike. Međutim, treba uzeti u obzir da je ITM okvirna mjera te kod osoba s velikom mišićnom masom može ukazati na pretilost iako nemaju višak tjelesne masti. Isto tako, u funkcionalnim sposobnostima nije dobivena značajna razlika, što je u skladu s tvrdnjom da su vještine hodanja i trčanja manje motoričke komponente te su zato manje zahvaćene utjecajem ITM-a (D'Hondt, Deforche, De Bourdeaudhuij, Lenoir, 2009). S obzirom na stanje uhranjenosti, podjednaki broj djece iz Zagreba i Dubrovnika

ima problema ili s prekomjernom tjelesnom masom ili pretilošću. Nsibambi (2013) na uzorku djece od 6 do 9 godina iz Ugande iznosi kako je 4 % djece pothranjeno, 85 % djece je normalno uhranjeno dok ih je 7 % prekomjerno teško i 4 % pretilo te se vidi kako puno manji postotak učenika iz ovog istraživanja ima normalnu tjelesnu masu. Podjednaki postotak vršnjaka iz Indije ima normalnu tjelesnu masu, dok druga polovica nema problema s prekomjernom tjelesnom masom kao u ovom istraživanju, već s drugom krajnošću, pothranjenošću (Srivastava, Mahmood, Srivastava, Shrotriya i Kumar, 2012).

Iako se očekivalo da će učenici iz Zagreba imati bolji antropološki status jer nastavu Tjelesne i zdravstvene kulture provode studenti Učiteljskog fakulteta pod nadzorom učiteljice i profesora s Učiteljskog fakulteta, rezultati su pokazali drugačije. Može se zaključiti da i učiteljice iz Dubrovnika također prate nastavni plan i program te veliku pažnju posvećuju tjelesnoj i zdravstvenoj kulturi. Isto tako, djeca iz Zagreba imaju puno veći izbor sportskih i rekreativnih sadržaja od djece iz Dubrovnika te su se i zbog toga očekivali drugačiji rezultati. Rezultati ovog istraživanja ostavljaju prostor za buduća istraživanja koja bi razjasnila zašto djeca iz Dubrovnika imaju bolji antropološki status od djece iz Zagreba.

ZAKLJUČAK

Iz dobivenih rezultata može se zaključiti kako su djeca iz Dubrovnika viša i teža od djece iz Zagreba, ali su isto tako postigli i bolje rezultate u većini motoričkih sposobnosti, dok u funkcionalnim sposobnostima nisu dobivene razlike. Može se zaključiti kako učenici iz Dubrovnika imaju bolji antropološki status. Istraživanje je pokazalo da antropološke promjene prate dobnu krivulju te da može doći do poboljšanja ili opadanja neke sposobnosti.

Postoci stanja uhranjenosti učenika iz obiju regija su alarmantni, te se može zaključiti kako gotovo polovica sudionika ne spada u grupu normalno uhranjene djece. Iako se razina tjelesne aktivnosti u ovom istraživanju nije mjerila, može se pretpostaviti kako većina učenika ne ispunjava minimalnu preporučenu normu od 60 minuta dnevne aktivnosti umjerenog do visokog intenziteta s obzirom na stanje uhranjenosti.

LITERATURA

Ajduković, M., iKolesarić, V. (ur.) (2003.) *Etičnikodeksistraživanja s djecom*. Zagreb: VijećezadjecuVladeRepublikeHrvatske. Državnizavodzaštituobitelji, materinstvaimladeži.

Akbari, H., Abdoli, B., Shafizadeh, M., Khalaji, H., Hajhosseini, S., iZiaee, V. (2009). The Effect of Traditional Games in Fundamental Motor Skill Development in 7-9 Year- Old Boys. *Iran J Pediatrics*, 19, 123–129.

vanBeurden, E., Barnett, L.M., Zask, A., Dietrich, U.C., Brooks, L.O., Beard, J. (2003). Can we skill and activate children through primary school physical education lessons? "Move it Groove it"—a collaborative health promotion intervention. *Preventive Medicine*, 36, 493–501 doi: 10.1016/S0091-7435(02)00044-0

Centers for Disease Control and Prevention (2000). *What is a BMI percentile?* Skinuto 2.6.2016. sastranice http://www.cdc.gov/healthyweight/assessing/bmi/childrens_bmi/about_childrens_bmi.html#What%20is%20BMI%20percentile

Dollman, J., Norton, K., Norton, L. (2005). Evidence for secular trends in children's physical activity behaviour. *Br J Sports Med*, 39(12), 892-897

Garow, J. S., i Webster, J. D. (1985). Quetelet's indeks (W/H²) as a measure of fatness. *Int J Obes Relat Metab Disord*, 9, 147-53.

Hardy, L.L, King, L, Espinel, P., Cosgrove, C., i Bauman, A. (2010). NSW schools physical activity and nutrition survey (SPANS). NSW Ministry of Health. Skinuto 2.6.2015. sa stranice http://sydney.edu.au/medicine/public-health/panorg/pdfs/SPANS_FullReport_2010.pdf

Mišigoj-Duraković, M. (2008). *Kin antropologija*. Zagreb: Kineziološki fakultet Sveučilišta u Zagrebu

Mišigoj-Duraković, M., i Duraković, Z. (2007). Antropološke i zdravstvene pretpostavke rada u kineziološkoj edukaciji, sportu i rekreaciji. U V. Findak (Ur.), *Zbornik radova 16. Ljetne škole kineziologa, „Antropološke, metodičke, metodološke i stručne pretpostavke rada u područjima edukacije, sporta, sportske rekreacije i kineziterapije“*. (str. 55.-59.). Hrvatski kineziološki savez

Nieto, F.J., Szklo, M., i Comstock, G.W. (1992). Childhood weight and growth rate as predictors of adult mortality. *Am J Epidemiol*, 136, 201-213

Nsibambi, C. A. N. (2013). Body Composition Analysis of Pupils in Urban Schools in Central Uganda. *IJBSS*, 4 (7), 135-141

Prebeg, Ž. (2002). Kakosuraslaškolska djeca u Hrvatskoj u posljednjim desetljećima drugog milenija. *Lijvij*, 124, 3-9

Prebeg, Ž., i Kern, J. (1977). Visina i težina zagrebačke školske djece i mladine. *Lijvij*, 99, 297-303

Prskalo, I. (2004). *Osnove kineziologije*. Udžbenik za studente učiteljskih škola. Petrinja: Visoka učiteljska škola.

Rivera, J.A., Barquera, S., Campirano, F., Campos, I., Safdie, M., i Tovar, V. (2002). Epidemiological and nutritional transition in Mexico: rapid increase of non-communicable chronic diseases and obesity. *Public Health Nutr*, 5, 113-22.

Srivastava, A., Mahmood, S.E., Srivastava, P.M., Shrotriya, V.P., i Kumar, B. (2012). Nutritional status of school-age children - A scenario of urban slums in India. *Archives of Public Health*, 70, 8. doi:10.1186/0778-7367-70-8

Stodden, D., Langendorfer, S., i Robertson, M.A. (2009). The association between motor skill competence and physical fitness in young adults. *Res Q Exerc Sport*, 80(2), 223-229.

Stodden, D.F., Goodway, J.D., Langendorfer, S.J., Robertson, M.A., Rudisill, M.E., Garcia, C., i Garcia, L.E. (2008). A Developmental Perspective on the Role of Motor Skill Competence in Physical Activity: An Emergent Relationship. *Quest*, 60, 290-306

WHO (2014). Obesity and overweight. Skinuto s mreže 2.6.2015. sa stranice <http://www.who.int/mediacentre/factsheets/fs311/en//index.html>

D'Hondt, E., Deforche, B., De Bourdeaudhuij, I., i Lenoir, M. (2009). Relationship between motor skill and body mass index in 5 to 10 year-old children. *Adapted Physical Activity Quarterly*, 26, 21-37

Spol i kronološka dob kao prediktori statusa motoričkog razvoja kod školske djece

Antonio Perić, Dino Belošević, Tanja Mandić

Kineziološki fakultet, Sveučilište u Splitu, Hrvatska

ABSTRACT

Aim of this paper was to investigate and explain effects of age and gender and their interactions with motor abilities of primary school students. As representatives of latent dimensions of agility, coordination, flexibility, power and strength we choose tests: side steps, polygon backwards, sit and reach test, broad jump and crunches. Research was conducted on a sample of 225 boys and girls from first, second and third grade primary school. Two-factor 2x3 ANOVA was used for statistical analysis and post-hoc Bonferroni analysis was performed only if statistically significant interactions were identified. Results indicate to the action of several key factors such as genetic, prenatal and social factors effecting significant differences in some motor variables between groups.

Key words: age, gender, motor abilities, gender differences, interaction

UVOD

Ispitivanje hijerarhijske strukturiranosti motoričkih sposobnosti, kako na općoj tako i na specijalnim populacijama različitih dobnih skupina uobičajeno zahtjeva korištenje terenskih testova. Ovakvi oblici testiranja nude brz, učinkovit, pouzdan i validan način prikupljanja ciljanih podataka u kontekstu istraživane problematike. Zasigurno su agilnost, koordinacija, fleksibilnost, snaga i jakost motoričke dimenzije od istaknutog značaja u kineziološkim, ali i povezanim interdisciplinarnim znanstvenim istraživanjima. Agilnost u osnovi svrstavamo u koordinacijsku sposobnost (Sekulić i Metikoš, 2007), iako na njen rezultat uvelike mogu utjecati i drugi faktori odnosno dimenzije kao što su

ravnoteža, brzina i snaga (Sekulić i sur., 2013). Iako je istraživanje multivarijatne i nelinearne dinamike njihovih interakcija čest problem znanstvene i stručne kineziološke prakse te količina zajedničkog varijabiliteta generalno egzaktne nepoznata, s pravom možemo vjerovati da je njihov statistički značajan utjecaj u nekim testovima agilnosti (t-test, zig-zag test, test agilnosti s okretom za 180° i sl.) vrlo vjerojatan. Nadalje, koordinacija podrazumijeva prostorno, vremenski i energetski efikasno izvođenje kompleksnih motoričkih zadataka. Važna dio u ovoj definiciji je riječ „kompleksno“, jer ako zadatak nije pojedincu kompleksan, iz izvjesnih razloga (ili ga dovoljno dobro poznaje ili je jednostavno „prelagan“) tada se u rezultat ispitivanja koordinacije biva saturiran integracijom nekih paralelnih mehanizama u njegovo izvođenje te se narušava valjanost dobivenih rezultata. Koordinacija kao kompleksna sposobnost kretanja ljudskog organizma ima manifestacije putem više neovisnih oblika, a sama spada pod faktor višeg reda mehanizma za reguliranje kretanja, preciznije „mehanizam za strukturiranje kretanja“ (Sekulić i Metikoš 2007). S druge strane, fleksibilnost je topološki određena te ono što vrijedi za jednu mišićnu skupinu ne mora vrijediti (i često ne vrijedi) za drugu. Tako primjerice, o rezultatima u standardnom testiranju fleksibilnosti putem testa pretklon raznožno, ne ovisi samo dužina *m. hamstrings* već i pokretljivost u donjem dijelu leđa. Istraživanja problematike snage, naročito snage nogu je istaknuta u suvremenoj znanstvenoj i stručnoj kineziološkoj praksi. Tako primjerice, istraživanja su potvrdila na studentima kineziologije visoku pouzdanost (Cronbach's alpha >.90) i dobru faktorsku valjanost testa skok u dalj s mjesta (Marković i sur., 2004). Problem nastaje u interpretaciji rezultata gdje se često poistovjećuje da osoba koja postigne bolji rezultat ima veću snagu donjih ekstremiteta. Treba reći da je snaga fizikalna mjera koja se izražava u Newtonima po metru u sekundi (N.m/s) odnosno Wattima. Količina ispoljene snage u skoku ne mora uvjetovati dužinu skoka, pa tako temeljem dužine skoka ne možemo tvrditi da netko ima veću snagu. Prvo, antropometrijske karakteristike, pogotovo na mlađim dobnim skupinama imaju utjecaj na rezultat u skoku i njegovu relacijom sa snagom (Kerns, 2013), pa tako dva individualca različite antropometrije mogu skakati na različite udaljenosti, ali proizvoditi istu snagu. Drugo, velik utjecaj na rezultat u eksplozivnim radnjama može proizvesti znanje tehnike (Tessier i sur., 2013). Naime, što ispitanici bolje poznaju tehniku to će rezultati u dužini skoka biti povezani s izlazom snage, no što je manje znanje tehnike to je veća razlika između uspješnosti u skoku i količini proizvedene snage. U literaturi se najčešće, unatoč ovim podacima, rezultati u skokovima i bacanjima predstavljaju kao

rezultati u snazi. Za potrebe ovog rada mi ćemo rezultate u varijabli skok u dalj s mjesta predstaviti kao rezultate u snazi, iako radi prije navedenih razloga treba uzeti u obzir da su rezultati uzeti kao predstavnici snage, a ne kao njezina direktna mjera, te da dobiveni rezultati mogu više ili manje korelirati s izlazom snage, ovisno o prikladnosti. Nadalje, jakost kao sposobnost mišića da proizvede silu zapravo je jedna od najistraženijih motoričkih sposobnosti u području kineziologije i sporta. Činjenica da je jakost toliko zanimljiva istraživačima i praktičarima ipak nije dovela do dovoljno velikog prijenosa tih informacija iz znanosti u praksu, pa potpuno razumijevanje mišićne jakosti izostaje. Tri su važne komponente skeletnih mišića i to: 1) sposobnost mišića da proizvede maksimalnu silu, 2) sposobnost mišića da proizvodi silu brzo, 3) sposobnost mišića da proizvodi silu kroz duži vremenski period (Graham-Smith i Less, 2005). Stoga, možemo reći kako se u samom terminu jakosti razilazi više različitih mehanizama mišića, pa se tako mogu i ispitivati pojedine mišićne sposobnosti u kojima jakost igra važnu ulogu.

U skladu sa prethodno navedenim, cilj rada utvrditi je identificirati i i objasniti razlike po spolovima i kronološkoj dobi unutar prva 3 razreda osnovne škole, i to u odabranim varijablama motorike prezentantima prethodno navedenih dimenzija.

METODE RADA

Uzorak ispitanika i varijabli

Istraživanje je realizirano korištenjem uzorka od 114 djevojčica i 111 dječaka koji pohađaju 1., 2. i 3. razred osnovne škole. Korištene varijable su koraci u stranu (MKUS), poligon (MPOL), pretklon raznožno (MPRR), skok u dalj s mjesta (MSDM) te podizanje trupa (MDTR).

Opis korištenih mjernih instrumenata

Test *koraci u stranu* (MKUS) ima za cilj utvrditi sposobnost promjene smjera kretanja (bočnog kretanja) predstavlja dimenziju agilnosti a sastoji se od 6 uzastopnih bočnih kretanja maksimalnom brzinom s ciljem da se zadana udaljenost prijeđe u što kraće vrijeme. Dvije trake postavljaju se na ravnu čvrstu površinu udaljenje 4 metra. Ispitanik se postavlja unutarjom nogom na jednu od linija (proizvoljno ljevu ili desnu) i čeka znak. Na znak ispitivača ispitnik što je brže moguće, bočnim dokoracima (bez križanja nogu), pokušava 6 puta u nizu prijeći navedenu distancu. Važno je da ispitnik vanjskom nogom

dotakne liniju prije nego promjeni smjer kretanja, ako to ne napravi dužina u kojoj je došlo do nepravilnosti se ne računa. Test se standardno izvodi 3 puta, a uzeta je najbolja vrijednost. Test *poligon unatraške* (MPOL) jedan je od najčešćih testova za ispitivanje koordinacije te se redovito provodi u osnovnim i srednjim školama a izvodi se na udaljenosti od 9 metara koja je podijeljena na točno 3 jednaka dijela (3x3 metra). Na prvoj trećini od startne linije postavljen je klupa, dok je na drugoj trećini postavljen okvir švedskog sanduka. Na znak ispitanik u četveronožnom položaju okrenut leđima od cilja ima zadatak u što kraćem vremenu doći do kraja poligona savladavanjem prepreka i pritom "ne narušavajući" četveronožni položaj. Preko prve prepreke (klupe) se penje, dok se kroz drugu prepreku (okvir od sanduka) provlači, te na kraju četveronožno ide u cilj. Test se ponavlja 3 puta i uzima se najbolji rezultat. Test *pretklon raznožno* (MPRR) mjera je mobilnosti u zglobovima leđa i kuka za fleksijski pokret. Najčešće se ovaj test povezuje s fleksibilnošću grupe mišića *m. hamstrings*, a nerijetko se predstavlja kao i mjera opće fleksibilnosti a realizira u sjedećem položaju raširenih nogu, te leđima i glavom naslonjenom na zid. Postoji nekoliko varijanti korištenja ovog testa, a u ovom radu korišten je modificirani test pretklona raznožno koji se pokazao kao najpouzdaniji i najpraktičniji oblik testiranja opsega pokreta za ovu regiju (Hui S. S. i Yuen P.Y., 2000). Ispitanik u navedenom početnom položaju ispruža spojene ruke u dlanovima maksimalno daleko između nogu a da pritom neodvoji leđa, glavu ili ramena od zida. Dužina dohvata se očitava te se uzima kao početna pozicija od koje će se dalje računati dužina pretklona. Ispitanik nakon toga savijanjem u leđima i kuku ide u maksimalan dohvat koji se mjeri. Vrijednost od početnog (nultog dohvata) i konačnog dohvata nakon maksimalnog savijanja uzima se kao rezultat mjerenja. Test se ponavlja 3 puta, a bilježi se najbolji rezultat. Test skok u dalj s mjesta (MSDM) standardno vežemo uz snagu nogu te je relativno jednostavan test. Ispitanik stane objema nogama ispred označene linije za početak skoka (ne smije ju prelaziti). Ispitaniku je dozvoljeno mahanje rukama u cilju povećanja amplitude skoka te smije napraviti par njihanja u cilju predistezanja radnih mišića. Skok se izvodi odrazom od podloge objema nogama te je cilj doskočiti što dalje. Izmjerena udaljenost uzima se od odrazne linije do najbliže točke koju je pokrio ispitanik. Test se izvodi 3 puta, a bilježi se najdalji rezultat. Test podizanje trupa (MSDM) test je koji u osnovi ispituje jakosne sposobnosti a ispituje izdržljivost u jakosti mišića trupa. Test se izvodi s ciljem ostvarivanja maksimalnog broja ponavljanja u 60 sekundi. Ispitanik leži na leđima sa savijenim nogama u zglobu kuka i koljena, sa stopalima na

podlozi, te se na znak podiže i spušta nazad što je brže moguće u vremenu od 60 sekundi. Mjere se samo ona podizanja koja su pravilno izvedena tj. samo ona u kojima ispitanik napravi potpuno spuštanje i dizanje trupa, na podlogu i od podloge. Test se izvodi samo jednom.

Metode obrade podataka

Izračunati su parametri deskriptivne statistike i to standardna devijacija i aritmetička sredina i to odvojeno za dječake i djevojčice po svim promatranim razredima. Kolmogorov-Smirnovljev test je korišten za ispitivanje normaliteta distribucije. Uzorak je ispitan na *outliere* te su 4 ispitanika eliminirana iz rezultata obzirom da su imali rezultat manji od 3σ . Korištena je 2x3 ANOVA-u s dodatnim korištenjem Bonferroni korekcije kada su identificirani značajni interacijski efekti. Koeficijent *partial eta squared* (η^2) korišten je za određivanje količine varijabiliteta kriterijske varijable koji je generiran nezavisnim varijablama.

REZULTATI

Unutar tablica 1-3 nalaze se rezultati deskriptivne statistike ali i značajnost pri testiranju normaliteta Kolmogorov-Smirnovljevim testom za dječake i djevojčice prvog, drugog i trećeg razreda u svim korištenim testovima.

Tablica 1. Parametri deskriptivne statistike na uzorku dječaka i djevojčica iz 1. razreda: aritmetička sredinu (AS), standardna devijacija (SD) te značajnost Kolmogorov Smirnovljevog testa normaliteta distribucije (KS-p)

	I razred			
	M ($n_1=40$)		Ž ($n_2=40$)	
	AS±SD	KS-p	AS±SD	KS-p
MKUS	199,60±62,07	<.10	180,09±28,66	<.20
MPOL	260,30±63,24	>.20	295,47±78,40	>.20
MPRR	34,23±8,43	>.20	38,38±11,67	>.20
MSDM	108,13±19,16	>.20	113,32±22,86	>.20
MDTR	21,65±5,95	>.20	20,15±5,96	>.20

Legenda: MKUS-koraci u stranu, MPOL-poligon, MPRR-pretklon raznožno, MSDM-skok u dalj s mjesta, MDTR-podizanje trupa

Tablica 2. Parametri deskriptivne statistike na uzorku dječaka i djevojčica iz 2. razreda: aritmetička sredinu (AS), standardna devijacija (SD) te značajnost Kolmogorov Smirnovljevog testa normaliteta distribucije (KS-p)

	II razred			
	M (n ₃ =35)		Ž (n ₄ =38)	
	AS±SD	KS-p	AS±SD	KS-p
MKUS	170.60±40.67	<.10	162.47±24.61	>.20
MPOL	231.43±72.77	>.20	276.55±66.84	>.20
MPRR	46.69±13.52	>.20	53.40±17.96	>.20
MSDM	127.63±20.87	>.20	112.66±18.04	>.20
MDTR	23.37±9.28	>.20	17.90±9.06	>.20

Legenda: MKUS-koraci u stranu, MPOL-poligon, MPRR-pretklon raznožno, MSDM-skok u dalj s mjesta, MDTR-podizanje trupa

Tablica 3. Parametri deskriptivne statistike na uzorku dječaka i djevojčica iz 3. razreda: aritmetička sredinu (AS), standardna devijacija (SD) te značajnost Kolmogorov Smirnovljevog testiranja normaliteta distribucije (KS-p)

	III razred			
	M (n ₅ =36)		Ž (n ₆ =36)	
	AS±SD	KS-p	AS±SD	KS-p
MKUS	148.36±14.68	>.20	154.87±19.14	>.20
MPOL	178.67±41.14	>.20	211.26±62.49	<.10
MPRR	46.89±20.55	<.20	50.47±18.47	>.20
MSDM	134.28±31.10	>.20	122.66±28.75	>.20
MDTR	27.03±8.16	>.20	23.92±6.70	>.20

Legenda: MKUS-koraci u stranu, MPOL-poligon, MPRR-pretklon raznožno, MSDM-skok u dalj s mjesta, MDTR-podizanje trupa

Iz tablica 1-3 može se utvrditi kako su sve varijable za sve promatrane grupe normalno distribuirane. Nadalje, unutar tablice 4 nalaze se rezultate dvofaktorske 2x3 ANOVA. Prikazane su značajnosti glavnih ali i interakcijskih efekata te veličina efekta putem koeficijenta *partial eta squared*.

Tablica 4. Rezultati dvofaktorske 2x3 ANOVA-e: F vrijednost (F), nivo značajnosti (p) i partial eta squared (η^2).

	SPOL			DOB			SPOL*DOB		
	F	p	η^2	F	p	η^2	F	p	η^2
MKUS	2.12	.147	.010	21.22	.000	.165	2.43	.090	.022
MPOL	18.47	.000	.079	31.82	.000	.228	.19	.827	.002
MPRR	5.20	.024	.024	17.12	.000	.137	.21	.814	.002
MSDM	4.90	.028	.022	10.17	.000	.086	3.75	.025	.034
MDTR	10.70	.001	.047	9.38	.000	.080	1.26	.287	.012

Legenda: MKUS-koraci u stranu, MPOL-poligon, MPRR-pretklon raznožno, MSDM-skok u dalj s mjesta, MDTR-podizanje trupa

Obzirom da je samo za varijablu MSDM identificiran statistički značajan interakcijski efekt faktora, u tablici 5 su za njega dani rezultati post-hoc analize korištenjem konzervativne Bonferroni korekcije.

Tablica 5. Rezultati post-hoc analize SPOL*DOB korištenjem Bonferroni korekcije u varijabli MSDM

DOB	SPOL	I i M	I i Ž	II i M	II i Ž	III i M
I	M					
I	Ž	1.000				
II	M	0.008	0.206			
II	Ž	1.000	1.000	0.121		
III	M	0.000	0.005	1.000	0.002	
III	Ž	0.118	1.000	1.000	1.000	0.567

Legenda: I- razred 1., II-razred 2., III-razred 3., M-dječaci. Ž-djevojčice

Iz dobivenih rezultata možemo utvrditi da su identificirane razlike u korištenim varijablama po spolovima potvrdile su se unutar 4 varijable i to u varijablama MPOL, MPRR, MSDM, MDTR, dok razlike nisu pronađene u varijabli MKUS. Nadalje, razlike u odabranim motoričkim varijablama po kronološkoj dobi potvrdile su utvrđene u svim korištenim varijablama. S druge strane, identificiran je samo jedan statistički značajan interakcijski efekt interakcije SPOL*DOB i to kod varijable MSDM.

RASPRAVA I ZAKLJUČAK

Potrebno je naglasiti da identificirane razlike po spolu koje su se pojavile u 4 varijable su očekivane, s naglaskom da su dječaci postigli bolje rezultate u MPOL, MSDM, MDTR, dok su djevojčice ostvarile bolji rezultat u varijabli MPRR. Poznato je da je fleksibilnost sposobnost koja je bolja razvijena kod žena, razlozi tome najčešće se pridodaju hormonalnim faktorima (Hewett 2000). Dodatno, istraživanja ukazuju na važnost ženskih spolnih hormona (estrogen i progesteron) u labavosti prednjeg križnog ligamenta (Heitz i sur., 1999). Ipak, ispitivane djevojčice u ovom istraživanju nisu ušle u fazu sazrijevanja pa čimbenik lučenja estrogena i progesterona zasigurno nije znatan. S drug strane, upravo navedeno nam može omogućiti uvid u utjecaj hormonalnih faktora na gibljivost ligamenata. Dobivene razlike tako dijelom možemo pripisati hormonalnim razlikama u prenatalnom razvoju ali vjerojatno i drugim genetskim faktorima. Nadalje, razlike u varijablama MPOL, MSDM i MDTR također možemo pripisati dijelom genetskim faktorima, ali dijelom i socijalnim faktorima. Tako primjerice, razlike u varijabli MPOL u dječaka vjerojatno ukazuju na veću aktivnost dječaka od djevojčica, pa tako dječaci mogu poboljšati svoje koordinacijske sposobnosti više od djevojčica do ove dobi. U varijablama MSDM i MDTR hormonalne razlike u prenatalnom razvoju vjerojatno su pogodovale da se dječaci odvoje od djevojčica u varijablama snage i izdržljivosti u jakosti, a osim toga moguća pozadina mogu biti i socijalni faktori koji utječu na povećanu aktivnost dječaka u odnosu na djevojčice. Suprotno navedenom, mogući razlozi neidentifikacije statistički značajnih razlika u varijabli MKUS su vjerojatno posljedica često bolje ravnotežne sposobnosti djevojčica u odnosu na dječake, koje tako vjerojatno prirodno nadoknađuju nedostatak u snazi. Ipak za preciznu identifikaciju pozadinskih mehanizama bi trebalo restrukturirati i produbiti istraživanja slična ovom. Razlike u odnosu na dob pokazale su se u svim dobnim skupinama, što vjerojatno možemo pripisati utjecaju faktora rasta i razvoja. Promatrajući interakcijske efekte, interesantno je uočiti da razlike unutar grupa po spolu i po dobi ukazuju na postojanje razlika samo u varijabli MSDM. Dodatnom post-hoc analizom utvrđeno je da su najistaknutije razlike između najstarije dobne skupine dječaka s ostalim razredima i to najviše ali i statistički značajno s prvim razredom neovisno o spolu, te s podgrupom drugog razreda koji predstavljaju djevojčice. Također zabilježene su razlike između dječaka drugog razreda i dječaka prvog razreda. Sve navedene razlike zasigurno najviše možemo pripisati rastu i razvoju, te genetskim faktorima, najvjerojatnije prenatalnim hormonalnim faktorima, te

u konačnici a možda još i važnije socijalnim faktorima. Navedeni čimbenici dječake stavljaju u poziciju veće aktivnosti naspram djevojčica, a posljedično u području snage tada prednost „dobivaju“ dječaci, te što su oni stariji to su razlike istaknutije.

U konačnici, možemo zaključiti kako razlike u najranijem razvoju dječaka i djevojčica mogu postaviti temelj za kasnije manifestacije razlika u nekim motoričkim varijablama. Potrebno je istaknuti da također socijalni razlozi uvelike utječu na tempo razvoja u prostoru motoričkih dimenzija te će dječaci imati bolje rezultate uslijed veće količine aktivnosti tipa trčanja, hodanja i drugih elementarnih tipova kretanja. Razlike po spolu koje su identificirane vjerojatno su kombinacija faktora, genetskih i socijalnih a pozicionirali su dječake ispred u varijablama u kojima je potreba proizvodnje sile veća, te u testovima u kojima je faktor za strukturu kretanja primaran. Djevojčice su tako očekivano bolje u testu fleksibilnosti, vjerojatno zbog razlika u prenatalnom razvoju. Razlozi razlika po dobi su apriorno jasni, utjecaj rasta i razvoja utječe na motoričke varijable i njihov napredak. Razlike unutar dobi i spola ukazuju da jedino varijabla snage znatno razlikuje podgrupe. Potreba za brzom proizvodnjom sile tako privilegira dječake starije dobi, najvjerojatnije uslijed veće aktivnosti dječaka od djevojčica, ali i moguće radi genetskih faktora.

LITERATURA

Graham-Smith, G., i Less, A. (2005). A three-dimensional kinematic analysis of the long jump take-off. *Journal of Sports Sciences* 23(9), 891-903.

Heitz, N.A., Eisenman, P.A., Beck, C.L., i Walker, J.A. (1999). Hormonal Changes Throughout the Menstrual Cycle and Increased Anterior Cruciate Ligament Laxity in Females. *Journal of Athletic Training* 34(2), 144-149.

Hewett, T.E. (2000). Neuromuskular and hormonal factors associated with knee injuries in female athletes. Strategies for intervention. *Sports Medicine* 29(5), 313-327.

Hui, S.S., i Yuen P.Y. (2000). Validity of the modified back-saver sit-and-reach test: a comparison with other protocols. *Medicine & Science in Sports & Exercise* 32(9), 1655-9.

Kerns, R.C. (2013). The Relationship of Anthropometric Measures to Vertical Jump Height. Undergraduate Honors Thesis. Paper 60.

Marković, G., Dizdar, D., Jukić, I., i Cardinale, M. (2004). Reliability and factorial validity of squat and countermovement jump tests. *J Strength Cond Res.* 18(3), 551-5

Sekulić, D., Spasić, M., Mirkov, D., Čavar, M., i Sattler, T. (2013). Gender-specific influences of balance, speed, and power on agility performance. *J Strength Cond Res.* 27(3), 802-11

Sekulić, D., i Metikoš, D. (2007). Osnove transformacijskih postupaka u kineziologiji. Redak Split.

Tessier, J.F., Basset, F.A., Simoneau, M., i Teasdale, N. (2013). Lower-limb power cannot be estimated accurately from vertical jump tests. *Journal of Human Kinetics* 38, 5-13.

Utvrđivanje povezanosti između različitih manifestacija reaktivne agilnosti

Barbara Kaličanin, Dora Marić, Ana Petrović

Kineziološki fakultet, Sveučilište u Splitu, Hrvatska

ABSTRACT

Pre-planned agility has more independent forms, but it is unknown whether there are such forms in non-planned (reactive) agility. The aim of this study was to determine the relationship between two forms of reactive agility (stop'n'go and non-stop). Subjects were male ($n = 40$) and female ($n = 15$) physical-education students. Reactive agility was estimated with stop'n'go and non-stop reactive agility tests. Correlation between mentioned tests was statistically significant ($r = 0,44$ $0,53$ for males and females, respectively $p < 0,05$). However tests share a small percentage of the common variance (16-25%), which indicates that they present independent qualities. The results indicate, that in the case of selecting tests it's necessary to determine pattern of movement that dominates in sport of interest.

UVOD

Agilnost dolazi od grčke riječi agilis što znači okretan, vriedan, brz, žustar. Postoje različite definicije i pogledi na agilnost, od kratkih i općenitih do opsežnih i kompleksnih (Sheppard i Young, 2006), ali svima je zajedničko da se agilnost vezuje uz brzu i uspješnu promjenu pravca kretanja. Veliki broj polistrukturalnih i kompleksnih sportova u svojoj strukturi sadržavaju promjene smjera kretanja sportaša u skladu s potrebama koje mu se nameću. Stoga, iako se autori ne slažu oko jasne definicije agilnosti gotovo da nema autora koji ne smatra kako je agilnost važna komponenta neophodna za uspješnu izvedbu u mnogim sportovima.

Dosadašnja istraživanja (Metikoš, Marković, Prot, i Jukić, 2003) utvrdila su kako postoji veliki broj manifestacija agilnosti, pa samim time i veliki broj

faktora koji utječu na njih. S obzirom da se promjena brzine i pravca kretanja u sportu odvijaju kako svojevoljno, tako i neplanirano te ovise o aktivnosti protivnika koja se u većini slučajeva ne može predvidjeti (Sekulić i Metikoš, 2007), najčešća podjela na koju nailazimo u novije vrijeme, odnosi se na agilnost u kojoj su promjene smjera kretanja unaprijed određene (pred-planirana), te agilnost u kojoj se promjena smjera kretanja izvodi kao reakcija na nekakav vanjski stimulus (neplanirana agilnost) (Uchida i sur, 2013).

Pred-planirana agilnost često se naziva i brzom promjenom pravca kretanja (engl. Change Of direction Speed - CODS), dok se neplanirana često imenuje kao „reaktivna agilnost“, a kako bi se naglasila potreba reakcije na vanjski, najčešće vizualni stimulans (Sekulić i sur., 2014). Teoretski pred-planirana i reaktivna agilnost počivaju na sličnoj fiziološkoj osnovi jer je za obje potrebna brza i intenzivna ekscitacija mišića. Stoga je očekivano da ove dvije sposobnosti budu korelirane, naravno pod uvjetom testiranja kroz slične lokomotorne forme. Međutim dosadašnja istraživanja pokazala su kao je povezanost navedenih mala do umjerena, te se radi od maksimalno 30% zajedničkog varijabiliteta (Sekulić, Krolo i sur. 2014).

Navedene manifestacije agilnosti mogu se testirati različitim, ali i gotovo identičnim testovima ukoliko za reaktivnu agilnost uključimo faktor iznenađenja kako bi dobili informaciju koliko dobro sportaš reagira na neočekivani stimulans. U testovima pred-planirane agilnosti smjer, oblici i pravci kretanja prilagođavaju se sportu od interesa, pa postoji veliki broj takvih testova u odnosu na reaktivnu agilnost, u kojoj promjena pravca i smjera kretanja ovisi o vanjskom podražaju.

Zbog nedostatka navedenih testova u novije vrijeme javljaju se različite modifikacije testova pred-planirane agilnosti (najčešće T-testa), ali i novokonstruirani testovi. Jedna od prvih verzija testa reaktivne agilnosti je Y test kojeg su razvili australski autori (Farrow, Young i Bruce, 2005; Sheppard i sur., 2006), specifično za test je „non-stop“ kretanje, što podrazumijeva da test uključuje promjenu smjera kretanja bez „nulte brzine“. S obzirom da se u sportu agilnost manifestira i kroz „stani-kreni“ kretanje, Sekulić i sur (Sekulić, Krolo i sur. 2014) razvili su aparaturu i proceduru koja omogućuje testiranje reaktivne agilnosti kroz stani kreni obrazac kretanja. Povezanost testova pred-planirane agilnosti stani-kreni obrascu kretanja i non-stop obrascu kretanja nije utvrđena, dok spoznaja o tome u slučaju reaktivne agilnosti još nema.

Stoga je cilj ovog rada utvrditi kolika je povezanost manifestacije reaktivne agilnosti koja uključuju „stani-kreni“ obrazac kretanja s manifestacijom koja uključuje „non-stop“ obrazac kretanja.

METODE RADA

Istraživanje se provelo na 55 ispitanika, 40 muških i 15 ženskih. Dob muških ispitanika je 21 ± 1.3 , dok je dob ženskih ispitanika 20.9 ± 1.6 godina. Svi ispitanici i ispitanice bili su studenti Kineziološkog fakulteta u Splitu, a mjereni su tijekom akademske godine 2014/2015. U trenutku testiranja svi ispitanici su bili zdravi, što je provjereno liječničkim pregledom prilikom upisa na studij Kineziologije na Sveučilištu u Splitu.

Uzorak varijabli u ovom istraživanju čine dvije varijable reaktivne agilnosti, odnosno dva testa reaktivne agilnosti, Y test i novokonstruirani test reaktivne agilnost (Sekulić, Krolo i sur. 2014) (slika 1.)

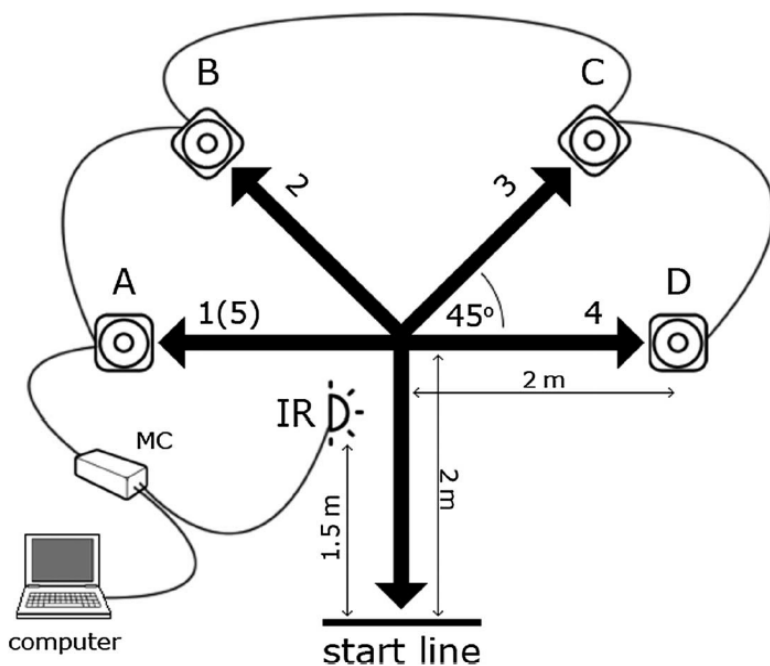

Slika 1. Prikaz opreme i poligona za izvedbu testa reaktivne agilnosti

Istraživanje je provedeno u Splitu, tijekom zimskog semestra 2014/2015 godine. Ispitanici su mjereni u oba testa isti dan, neki ispitanici najprije su odrađivali testiranje na Y testu, a drugima je po rasporedu najprije dolazio novokonstruirani test reaktivne agilnosti, pa tek onda Y test. Na taj način se izbjegao efekt redoslijeda u testiranju. U narednoj fazi rezultati su statistički obrađeni i interpretirani.

TRENDS IN PHYSICAL EDUCATION
TRENDOVI U TJELESNOJ I ZDRAVSTVENOJ KULTURI

Opis samog testiranja jednog i drugog test iznesen je u nastavku.

Y test - radi se o relativno jednostavnoj izvedbi testa u kojoj sportaš ima zadatak pretrčati kurs u obliku slova Y i to tako da u jednom trenutku dobije informaciju treba li krenuti desno ili lijevo. U testu se izvodi samo jedna promjena smjera kretanja koja je određena signalom kojeg ispitanik prima u momentu kada prođe kroz fotočeliju na što se šalje signal i pali se lampica bilo na lijevoj ili desnoj strani. Specifično kod testa je to što uključuje promjenu smjera kretanja, ali bez momenta „nulte brzine“, jer sportaš pod kutom od okvirno 30 do 45 stupnjeva mijenja smjer kretanja. Testiranje je provedeno u tri čestice. Između čestica pauza je bila 3-5 minuta, a kao rezultat uzimalo se najbolje vrijeme.

Novokonstruirani test reaktivne agilnosti (RAG) - Ispitanik kreće sa startne linije u trenutku kada je spreman. Vrijeme se počinje mjeriti u trenutku kad ispitanik pređe infra crveni signal (IR). Kad ispitanik presiječe IR signal hardverski modul pali jednu od četiri lampe koje su smještene unutar čunjeva visokih 30 cm (čunjevi označeni slovima A, B, C, D). Ispitanik mora prepoznati koji čunj svijetli otrčati maksimalno brzo do tog čunja, dotaknuti vrh čunja i vratiti se na startnu liniju što je brže moguće. Nakon što ugazi ili prijede startnu liniju nogom po vlastitom izboru okreće se i ponovno trči preko poligona. Svaki put kad ispitanik presiječe IR signal mikrokontroler pali jednu od četiri lampe. Jedna čestica testa sastoji se od pet kursova, jedna čestica je gotova kad ispitanik presiječe IR signal nakon što se vrati sa petog kursa. Tri čestice se izvode kod svakog ispitanika. Svi ispitanici testirani su uz korištenje tri jednaka scenarija kroz tri čestice testiranja, ali ih nisu znali unaprijed. Prvi scenarij bio je: 13131414. Drugi scenarij bio je: 14121314. Treći scenarij bio je: 12121213. Najbolji rezultat od tri čestice zadržan je kao finalni rezultat za svakog ispitanika. Premda, oprema za testiranja dozvoljava testiranje slučajni odabirom scenarija, jednaki scenariji upotrebljavani su kod svih ispitanika kako bi se osigurali jednaki uvjeti testiranja za sve ispitanike.

Obrada rezultata uključivala je deskriptivne statističke procedure te korelacijsku analizu kojom se utvrdila povezanost „Y“ testa s novo konstruiranim testom reaktivne agilnosti. Sve analize rađene su odvojeno za po spolu.

REZULTATI

Premda deskriptivni rezultati nisu statistički uspoređivani između spolova, vidljivo je da muški ispitanici postižu bolje rezultate u oba testa reaktivne agilnosti, u odnosu na ispitanice (Tablica 1).

Povezanost varijabli reaktivne agilnosti mjerene Y testom i novo konstruiranim testom (RAG) značajna je i kod muških ispitanika i kod ispitanica (Tablica 2; Slika 1 i 2), međutim ukoliko u obzir uzmemo količinu zajedničkog varijabiliteta (kvadrirani koeficijent korelacije), koja za ispitanice iznosi 28.09% , dok za muške ispitanike iznosi 19.36 % , ove dvije varijable reaktivne agilnosti ne možemo smatrati istom sposobnosti.

Tablica 1. Deskriptivna statistika analiziranih varijabli (AS - aritmetička sredina; Min - minimalni rezultat; Max - maksimalni rezultat; SD - standardna devijacija)

	Muški				Žene			
	AS	Min	Max	SD	AS	Min	Max	SD
RAGMIN	9,08	8,00	10,61	0,69	10,17	9,15	12,44	0,93
YMIN	2,33	1,97	2,82	0,22	2,49	2,13	3,50	0,33

LEGENDA: RAGMIN - novo konstruirani test reaktivne agilnosti; YMIN - „Y“ test

Tablica 2. Linearna korelacijska analiza varijabli reaktivne agilnosti mjerene Y testom i novo konstruiranim testom za muške ispitanike (M) i ispitanice (Ž); * označava značajne koeficijente korelacije

	RAGMIN	
	M	Ž
YMIN	0,44*	0,53*

LEGENDA: RAGMIN - novo konstruirani test reaktivne agilnosti; YMIN - „Y“ test

Slika 1. Grafički prikaz korelacijske analize varijabli reaktivne agilnosti mjerene Y testom i novo konstruiranim testom, za muške ispitanike

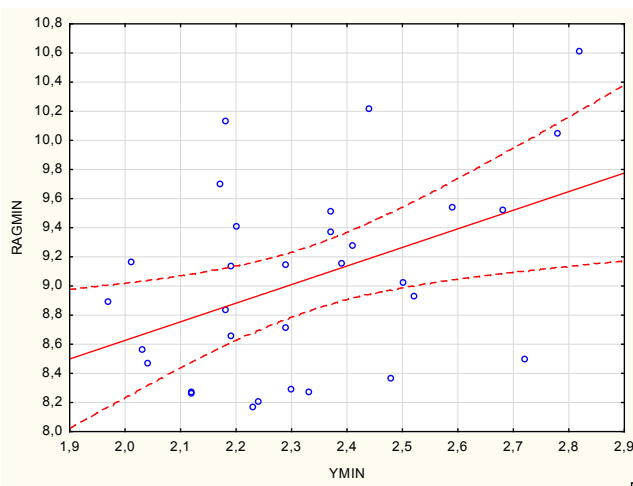

Slika 2. Grafički prikaz korelacijske analize varijabli reaktivne agilnosti mjerene Y testom i novo konstruiranim testom, za ispitanice

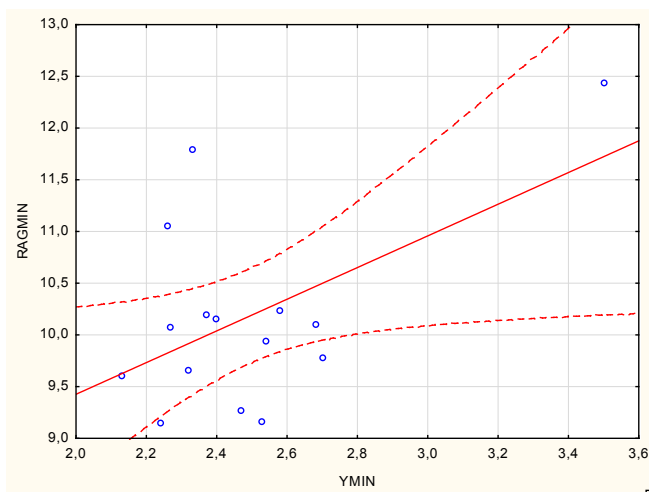

RASPRAVA

Osnovna ideja ovoga rada bila je provjeriti postojanje povezanosti manifestacije reaktivne agilnosti koja uključuju stani-kreni obrazac kretanja s manifestacijom koja uključuje non-stop obrazac kretanja.

Iz dobivenih rezultata vidljivo je da navedene manifestacije ne predstavljaju istu sposobnost kako kod ispitanika, tako i kod ispitanica, stoga o korelaciji varijabli možemo govoriti generalno. Naime pretpostavka je da postoji više objašnjenja zašto se povezanost među varijablama nije pokazala značajnom, odnosno zašto ove dvije testirane manifestacije reaktivne agilnosti ne predstavljaju istu sposobnost. Kao prvu pretpostavku možemo navesti razliku u obrascu kretanja.

U Y testu javlja se non-stop obrazac kretanja, jer test uključuje promjenu smjera kretanja bez momenta nulte brzine, dok se u novo konstruiranom testu javlja „stani-kreni“ obrazac kretanja zbog postojanja momenta zaustavljanja pri promjeni pravca kretanja (moment nulte brzine). U dosadašnjim istraživanjima pred-planirane agilnosti pokazalo se kako se testovi iznimno razlikuju baš po navedenim obrascima kretanja.

Preciznije u testovima pred-planirane agilnosti koji se izvode u „non-stop“ kretanju, dominantan je utjecaj brzine sprinta, dok je u testovima pred-planirane agilnosti u kojima se javlja stani kreni-obrazac dominantna uloga

eksplozivne snage i ravnoteže (Sekulić, Spasić i Esco, 2014; Spasić i sur., 2013). Isto tako u testovima „stani-kreni“ obrasca kretanja u momentima zaustavljena ispitanika u pojedinim točkama moment inercije, koji je izravno ovisan o masi tijela, izbacuje tijelo iz ravnoteže i negativno djeluje na izvedbu testa agilnosti (Dželalija i Rausavljević, 2005). Tom momentu inercije više pridonosi balastna masa tijela (potkožno masno tkivo), nego mišićno tkivo. Što konačno dovodi do većeg utjecaja masnog tkiva na test agilnosti kod kojih se ispitanik „zaustavlja“ (RAG), nego kod testa u kojem zaustavljanja nema (Y).

Još jedan važan faktor koji treba uzeti u obzir je faktor zamora, koji se javlja u novo konstruiranom testu. Naime test traje duže i ima veći broj ponavljanja, od Y testa. Stoga zbog dužine trajanja (trajanje od svega deset sekundi) i čestih ekscentrično - koncentričnih kontrakcija uslijed zaustavljanja i ponovnog kretanja dolazi do zamora, pa je pretpostavka da će oni ispitanici koji su dobro trenirani u anaerobnim uvjetima rada zadržati stabilnost izvedbe od čestice do čestice, dok će oni ispitanici koji nisu dobro trenirani u anaerobnim uvjetima rada zabilježiti blagi pad vrijednosti, bez obzira na trajanje pauze između čestica.

Uz gore navedene pretpostavke važno je napomenuti i činjenicu da u Y testu ispitanik samo u jednom momentu donosi odluku o daljnjem smjeru kretanja, ovisno o vizualnom podražaju, što nije slučaj u drugom testu gdje ispitanik o momentu kretanja odlučuje u više navrata, iz toga proizlazi da u Y testu postoji daleko veća mogućnost slučajnog odabira ispravnog smjera kretanja, što umanjuje vrijednost brzine reakcije kao važnog faktora u testu.

ZAKLJUČAK

Provedeno istraživanje ukazuje na činjenicu da promatrani testovi nisu manifestacija iste sposobnosti. Točnije, oni predstavljaju različite manifestacije reaktivne agilnosti. Jasno je stoga da se navedene manifestacije razlikuju po parametrima koji utječu na njih, a najočitija razlika ona je u obrascu kretanja. Preciznije, u jednom testu riječ je o „stani-kreni“ obrascu kretanja dok se u drugom javlja „non-stop“ obrazac kretanja. Ostaje zaključiti da ukoliko navedene testove želimo primijeniti u sportu ili iz njih razviti test specifične procedure potrebno je uvažiti činjenicu da se reaktivna agilnost može manifestirati kroz dva navedena obrasca. Ukoliko nam je cilj utvrditi stanje reaktivne agilnosti sportaša potrebno je utvrditi koji obrazac kretanja dominira u sportu od interesa te prema tome vršiti odabir testa ili tu informaciju upotrijebiti pri konstrukciji novog sport specifičnog testa.

Literatura

Dželalija, M., i Rausavljević, N. (2005.). *Biomehanika sporta*: Fakultet prirodoslovno matematičkih znanosti i odgojnih područja, Sveučilište u Splitu.

Farrow, D., Young, W. i Bruce, I. (2005.). The development of a test of reactive agility for netball a new methodology. *J. Sci Med Sport*, 8 (1), 52-60.

Metikoš, D., Marković, G., Prot, F., i Jukić, I. (2003). Latent structure of agility obtained by a battery of tests. *Kinesiology* 35(1): 14-29.

Sekulic, D., Krolo, A., Spasic, M., Uljević, O., Perić, M. (2014). The Development of a New Stop'n'go Reactive-Agility Test . *Journal of Strength and Conditioning Research*, 28(11) - p3306-3312.

Sekulić, D., i Metikoš, D. (2007). *Osnove transformacijskih postupaka u kineziologiji*: Sveučilište u Splitu, Fakultet PMZK.

Sekulic, D., Spasic, M., &Esco, M. R. (2014). Predicting agility performance with other performance variables in pubescent boys: a multiple-regression approach. *Percept Mot Skills*, 118(2), 447-461.

Sheppard, J. M., i Young, W. B. (2006). Agility literature review: Classifications, training and testing. *Journal of Sports Sciences*, 24(9), 919-932.

Uchida, Y., Demara, S., Nagayama, R. i Kitabayashi, T. (2013). Stimulus tempos and the reliability of the successive choice reaction test. *Journal of Strength and Conditioning Research*, 27(3), 848-853.

Postoje li razlike u plivačkoj izvedbi između dviju grupa studenata kod provođenja identičnog plivačkog programa kroz dva različita vremenska perioda?

Karla Šitić, Goran Gabrilo, Mia Perić

Kineziološki fakultet, Sveučilište u Splitu, Hrvatska

ABSTRACT

The main objective of this study was to determine the differences in swimming performance of two generations of male students of Kinesiology. The sample of subjects comprised 90 male students, including 47 students of generation 2013/2014 (GEN13) and 43 students of generation 2014/2015 (GEN14). GEN13 did their swimming training throughout a period of 15 weeks, and training sessions took 2 times a week for 45 minute, while GEN14 had the same training programme for 7.5 weeks, but 4 times a week for 45 minutes. The sample of variables consisted of 4 swimming variables: 25 meters freestyle (25mS), 50 meters freestyle (50mS), 400 meters freestyle (400mS), 50 meters butterfly (50mD). Apart from a descriptive analysis, t-test for independent samples to determine statistically significant differences between groups, and t-test for paired samples to determine difference between initial and final testing were used. Results showed improvement in all swimming variables regardless of swimming program. Significant differences between PROGRAM1 and PROGRAM 2 were found in variables: 25mS, 50mS, 400mS. Results suggested a positive effect of both programs, but students in PROGRAM 2 showed significantly better swimming performance at final testing than student in PROGRAM 1.

Key words: swimming, training program, students

UVOD

Naučiti se dobro održavati u vodi i koristiti plivanje kao oblik rekreacije ili treninga možemo postići isključivo plivačkim treningom. Plivački trening

dio je pedagogike, procesa odgoja, te učenja motoričkih struktura. Proces poboljšanja motoričkih i funkcionalnih sposobnosti, te proces formiranja psihički i socijalno adaptirane ličnosti, također se postiže kroz treninge plivanja (Volčanšek, 2002).

Cilj svakog treninga je plansko programiranje vježbi kako bi se njime formirao svestrani razvoj tjelesnih i psihičkih kvaliteta, a kako bi osoba optimalno funkcionirala u uvjetima sportskih zahtjeva (Bompa i Haff, 2009). Trening kao planski proces u sportu i sportskoj aktivnosti, pa tako i u plivanju, razlikuje se po kvaliteti, kvantiteti i vremenu trajanja. Plivački trening je u funkciji stvaranja preduvjeta za kvalitetno funkcioniranje cjelokupnog sustava, te kvalitetan sadržaj treninga jedan je od osnovnih činitelja koji djeluje na programirane antropološke promjene i omogućava optimalno razvijanje i funkcioniranje mišića i organa kao osnovnih čimbenika u sportu (Salo i Riewald, 2008). Specifični mehanizmi procesa adaptacije organizma na plivački trening dobro su poznati, te uključuju pojačani rad srčanog sustava i smanjen puls na zadanom opterećenju, povećanu mišićnu prokrvljenost i učinkovitiju uporabu kisika i mehanizma koji troše energiju (Obert i sur. 1998). Također, osiguravaju povećanu lokalnu mišićnu snagu i izdržljivost, bolju živčano-mišićnu koordinaciju i bolju mehaničku učinkovitost pri zadanom opterećenju (Colwin, 1993).

Kako je plivanje jedan od „najvećih“ olimpijskih sportova kojeg krasi četiri različite tehnike plivanja, te 21 olimpijska disciplina, tako se i isprepliću sva tri sustava dopreme energije (anaerobni alaktatni, anaerobna glikoliza, aerobni sustav) ovisno o zahtjevima pojedine discipline (Costill i sur. 1992). Nadalje, postoje tri glavne vrste treninga čiji se učinci kombiniraju prema specifičnim energetskim zahtjevima pojedinih plivačkih disciplina. Osnovni cilj aerobnog treninga je izgradnja aerobne izdržljivosti kako bi plivač mogao plivati duže i brže prije nego dođe do nagomilavanja laktata u mišićima. Svrha anaerobnog treninga je svjesno povećanje koncentracije laktata u mišićima kako bi se bolje prilagodili na toleranciju istih. Trening brzine koristi ATP i CP za proizvodnju energije, a u takvom treningu koriste se dionice od 12.5-25m, što omogućava održavanje maksimalne brzine plivanja bez crpljenja energije iz sustava anaerobne glikolize (Colwin, 1993). Baš zbog toga, najveću pažnju na velikim natjecanjima su oduvijek plijenili plivači koji su mogli uspješno kombinirati različite plivačke discipline i dionice.

Kvantitet-količina treninga, također je značajan činitelj u trenažnom procesu, te je visok volumen treninga nešto što je gotovo neizostavno u suvremenom pristupu plivanju. Kvantitet se definira kao volumen isplivanih kilometara ili utrošenih sati na plivačkom treningu. Pažljivo izbalansiran omjer dužine i intenziteta rada od vitalne je važnosti jer previše intenzivan trening često završava neuspjelim adaptacijom (Colwin, 1993). Vrijeme trajanja treninga registrira se u minutama i satima. Kod plivača početnika trenažni stimulus traje od 20 do 60 minuta (Blanksby i sur., 1995; Sideraviciute i sur., 2006; Jerszynski i sur., 2013). Poznato je da su trenažni efekti kod plivača početnika bolji, ako trening ne traje dugo, već je učestalost samih trenažnih jedinica veća, i to zbog brze pojave umora, te sumiranja trenažnih efekata (Volčanšek, 2002). Literarni navodi otkrivaju čitav niz plivačkih programa s različitim tjednom kvantitetom treninga, te ukupnim trajanjem. Plivački programi za plivače početnike variraju od dva do četiri puta tjedno, kroz period od 8 do 14 tjedana (Stransky i sur. 1979; Sideraviciute i sur. 2006; Garrido i sur. 2010). Svi navedeni programi su pokazali napredak u mnogim varijablama antropološkog statusa, međutim, znanstveno nije kvantificirano koliki je optimalan broj plivačkih treninga u jednom tjednu da bi se postigli maksimalni efekti pojedinog plivačkog programa.

Cilj ovog rada je utvrditi postoje li razlike u pojedinim plivačkim sposobnostima između dvije skupine ispitanika nakon što su podvrgnuti identičnom plivačkom programu, ali kroz različiti vremenski period. Također, cilj je bio utvrditi razlike između finalnog i inicijalnog mjerenja kod obje grupe ispitanika, te na taj način ukazati na eventualnu opravdanost obaju programa.

METODE RADA

U ovom istraživanju uzorak ispitanika sačinjavalo je 90 muških studenata druge godine prediplomskog studija Kineziologije u Splitu, od toga: 47 muških studenata akademske godine 2013./2014. (PROGRAM 1), te 43 muška studenta druge godine prediplomskog studija Kineziologije u Splitu, akademske godine 2014./2015. (PROGRAM 2), (N= 90). Svi ispitanici bili su podvrgnuti istom plivačkom edukacijskom programu, koji je proveden kroz 30 školskih sati u sklopu kolegija „Teorija i metodika plivanja 2“. Na razvoju aerobnih sposobnosti radilo se 12 sati, 10 sati utrošeno je na razvoj anaerobnih sposobnosti, a 8 sati na razvoj brzine. Dakle, struktura programa bila je ista za obje skupine, ali se

on razlikovao u vremenskom trajanju. PROGRAM 1 se provodio kroz 15 tjedana (2 puta tjedno), dok se PROGRAM 2 provodio kroz 7.5 tjedana (4 puta tjedno), i svi u trajanju školskog sata od 45 minuta (slika 1). Bitno je naglasiti da su svi studenti prethodno odradili nastavu kolegija „Teorija i metodika plivanja 1“, te da su poznavali tehniku plivanja slobodnim stilom.

U provedenom testiranju mjerili su se rezultati u varijablama 25 metara slobodno (25mS), 50 metara slobodno (50mS), 400 metara slobodno (400mS) i 50 metara delfin (50mD), a mjerenje se provelo na početku (inicijalno mjerenje) i na kraju oba plivačka programa (finalno mjerenje).

U sklopu obrade podataka korišten je program *Statistica 12*, te su izračunati sljedeći parametri deskriptivne statistike: aritmetička sredina (AS), standardna devijacija (SD), minimalni rezultat (MIN), maksimalni rezultat (MAX).

Razlike između rezultata PROGRAM 1 i PROGRAM 2 u finalnom mjerenju izračunate su korištenjem t-testa za nezavisne uzorke, isto kao i razlike u inicijalnom mjerenju. Razlika svakog pojedinog plivačkog programa mjenenog u dvije vremenske točke, odnosno razlike između inicijalnog i finalnog mjerenja, utvrđene su korištenjem t-testa za zavisne uzorke.

Slika 1: Ilustrirani prikaz provedbe trenajnih jedinica PROGRAMA 1 i PROGRAMA 2 po tjednima.

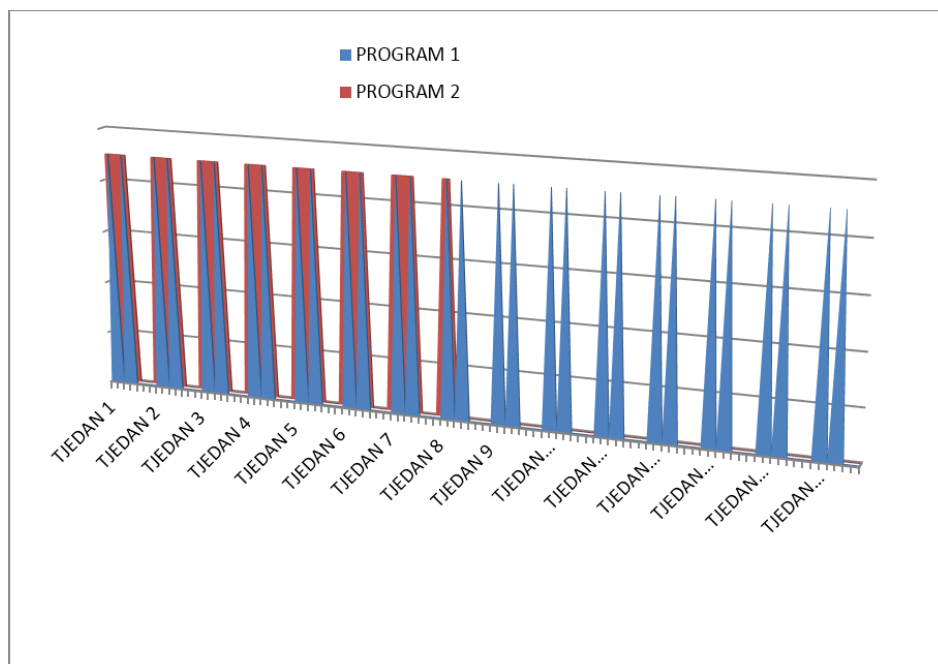

REZULTATI

Tablica 1.: AS – aritmetička sredina; MIN – minimalan rezultat; MAX – maksimalan rezultat; SD – standardna devijacija; * -prikazuje statistički značajne razlike između inicijalnog i finalnog mjerenja; [♠] -prikazuje statistički značajne razlike između „PROGRAM 1” i „PROGRAM 2”.

Variable		PROGRAM 1				PROGRAM 2			
		MIN	MAX	SD	AS	MIN	MAX	SD	
INICIJALNO MJERENJE	25mS	15,42	13,13	18,13	1,26	14,98	13,29	17,97	1,08
	50mS	35,16	31,56	39,78	2,28	34,46	29,97	41,07	2,73
	400mS	500,78	101,00	692,02	90,97	482,13	345,56	599,03	60,70
	50mD	51,13	35,79	78,40	8,76	49,23	35,25	66,72	8,24
FINALNO MJERENJE	25mS	15,10 *	12,91	17,50	1,06	14,56 * [♠]	12,84	16,84	1,10
	50mS	33,90 *	30,06	36,97	1,95	32,85 * [♠]	28,91	40,94	2,57
	400mS	452,63 *	415,43	501,44	22,48	422,64 * [♠]	329,59	508,16	37,61
	50mD	45,82 *	37,06	51,90	3,84	44,14 *	34,78	55,10	5,55

Legenda: 25mS – 25 metara slobodno, 50mS – 50 metara slobodno, 400mS – 400 metara slobodno, 50mD – 50 metara delfin.

U tablici 1 vidljivo je da postoje statistički značajne razlike između inicijalnog i finalnog mjerenja u svim varijablama i kod sudionika PROGRAMA 1 i kod sudionika PROGRAMA 2, a aritmetičke sredine ukazuje da se radi o napretku kod oba programa.

Isto tako, vidljivo je da nema statistički značajnih razlika između sudionika PROGRAMA 1 i PROGRAMA 2 na početku tetmana (inicijalno mjerenje).

Međutim, postoje statističke značajne razlike između studenata podvrgnutih PROGRAMU 1 i studenata koji su odradili PROGRAM 2 u finalnom mjerenju, i to u svim varijablama osim 50mD, a aritmetičke sredine ukazuju da bolje rezultate u finalnom mjerenju imaju studenti PROGRAMA 2.

RASPRAVA

Iz prikazanih rezultata, vidljivo je da oba plivačka programa doprinose pozitivnim promjenama, odnosno da bez obzira na vremenski period kroz koji se program provodi, dolazi do poboljšanja plivačkih sposobnosti među populacijom studenata. Možemo reći da je to i logično, jer tome je pridonio sustavan rad na aerobnoj i anaerobnoj izdržljivosti, te brzini, a upravo su to plivačke varijable i mjerile. Nadasve, čitav niz studija potvrđuje napredak plivača početnika podvrgnutih raznim plivačkim tretmanima, bez obzira na njihovo trajanje i tjednu učestalost plivačkih podražaja (Sideraviciute i sur. 2006; Stransky i sur. 1979; Garrido i sur. 2010). Također, među populacijom vrhunskih plivača provedene su studije koje su imale za cilj utvrditi napredak nakon provedenih plivačkih programa. Jedna od takvih studija (Mujika i sur., 1995.) je proučavala utjecaj intenziteta, volumena i frekvencije treninga na plivačku izvedbu kod skupine elitnih plivača tijekom plivačke sezone. Rezultati istraživanja pokazali su da je intenzitet treninga ključni faktor u proizvodnji trenažnog učinka, što dovodi do poboljšanja u izvedbi tijekom sezone. Nadalje, nekoliko studija sugeriraju da visoki ekstenzitet treninga ne daje bolje benefite u odnosu na niži ekstenzitet, te se na taj način ponovno intenzitet treninga postavlja kao ključni faktor (Aspenes i Karlsen, 2012). Naime, kroz 45 minuta plivačkog tretmana, nemoguće je postići visoki ekstenzitet. Stoga, možemo ustvrditi da je postignuti napredak kod oba plivačka programa očekivan te da potvrđuje ispravnost plana i programa navedenog kolegija.

Prilikom analize razlika u plivačkom napretku kod populacije studenata, ovisno o učestalosti provođenja trenažnih jedinica, vidljivo je da postoje razlike između PROGRAMA 1 i PROGRAMA 2. Iz dobivenih rezultata vidljivo je da kod inicijalnog mjerenja nema statistički značajnih razlika između PROGRAMA 1 i PROGRAMA 2, što je odličan preduvjet za pretpostavku kako su studenti krunuli s iste „polazišne točke“. Svi su studenti prethodno odradili kolegij „Teorija i metodika plivanja 1“, te kroz tih 30 sati uspješno savladali tehniku slobodnog stila plivanja. Dakle, možemo reći da su na početku edukacijskog programa, a uzimajući u obzir znanje plivačke tehnike slobodnog stila i delfina, kao i funkcionalne i motoričke sposobnosti, bili na istom nivou.

Promatrajući rezultate koje smo dobili kod finalnog mjerenja statistički značajne razlike postoje između PROGRAMA 1 i PROGRAMA 2. Razlike su značajne u svim varijablama (25mS, 50mS, 400mS) osim u varijabli 50mD, a vidljivo je da su studenti PROGRAMA 2 postigli bolje rezultate. Iako nema istraživanja koja su se bavila istim trenažnim programom kroz dva različita vremenska perioda, u ovom istraživanju se ispostavilo da jednak broj treninga u kraćem vremenskom periodu dovodi do bržeg/boljeg napretka.

Mujika I. (1998), provodi istraživanje koje je proučavalo kombinaciju smanjenja učestalosti treninga i volumena, i to kod plivača natjecatelja. Nakon 5 mjeseci redovitog treninga (8300 metara dnevno, 6 dana u tjednu), plivači su bili svrstani u grupe. Prva je grupa plivala 2800 metara dnevno, 3 puta tjedno. Druga je grupa plivala 2800 metara dnevno i to samo jedan dan u tjednu, dok treća grupa nije imala plivački trening cijela 4 tjedna. Maksimalni primitak kisika i mehanika zaveslaja bili su nepromijenjeni samo kod prve skupine. Iako je mišićna snaga održana u svim skupinama, njihova je plivačka sposobnost značajno pala. Dakle, frekvencija trenažnog stimulusa od izrazitog je značaja za plivačku izvedbu. Dok trenažne adaptacije mogu lako biti održavane sa malom frekvencijom broja treninga kod umjereno treniranih osoba, mnogo veća frekvencija treninga od visokog je značaja za poboljšanje plivačke izdržljivosti i brzine.

Jedina varijabla kod koje nije bilo razlika između PROGRAMA 1 i PROGRAMA 2 je 50mD. Možemo pretpostaviti da su kod izvedbe u disciplinama slobodne tehnike na konačan rezultat utjecale prvenstveno funkcionalne sposobnosti, i to aerobne i anaerobne, kao i sama brzina plivanja, a u manjoj mjeri tehnika plivanja, jer su studenti imali prethodno znanje stečeno kroz 30 sati edukacije kraul tehnike (Teorija i metodika plivanja 1). Edukacija tehnike delfin se vršila zadnjih deset do petnaest minuta svakog sata kroz kolegij „Teorija i metodika plivanja 2“. Međutim, vidljiv je izrazit napredak u rezultatu i kod PROGRAMA 1 i kod PROGRAMA 2 (prosječno gotovo 6 sekundi). Kako je delfin koordinacijski i tehnički najzahtjevnija tehnika, „najveći dio“ napretka je najvjerojatnije ostvaren upravo poboljšanom izvedbom tehnike delfin, a ne poboljšanjem sposobnosti. Stoga, vjerojatno i nema razlika kod finalnog mjerenja između PROGRAMA 1 i PROGRAMA 2.

ZAKLJUČAK

Iz navedenih i diskutiranih rezultata možemo zaključiti kako je postignuti napredak kod oba plivačka programa te se potvrđuje ispravnost plana i

programa kolegija „Teorija i metodika plivanja 2“. Također, studenti koji su bili podvrgnuti „PROGRAMU 2“ i proveli edukaciju u kraćem vremenskom periodu, imali su bolje konačne rezultate plivačkih sposobnosti. Moguće da je ovakav način provođenja trenažnog programa studentima naporniji, ali učestaliji trenažni stimulusi dovode do bržeg/boljeg napretka, te se svakako treba provoditi na takav način. Naravno, trebalo bi voditi računa o sveukupnom opterećenju studenata, da plivački program ne završi s neuspjelom adaptacijom zbog prevelikog volumena opterećenja.

LITERATURA

Aspenes, S. T., Karlsen, T. (2012) Exercise – training intervention studies in competitive swimming (Review). *Sports Medicine*. 42(6): 527-543.

Blanksby, B.A., Parker, H.E., Bradley, S., Ong, V. (1995). Children's readiness for learning front crawl swimming. *Australian Journal of Science and Medicine in Sport*. 27(2): 34-37.

Bompa, T., Haff, G. G. (2009). Periodization-5th Edition: Theory and Methodology of Training. *Human Kinetics*.

Colwin, C.M. (1993). Swimming into the 21st century. *Human Kinetics*.

Costill, D.L., Maglischo, E.W., Richardson, A.B. (1992). Swimming. *Wiley-Blackwell*.

Garrido, N., Marinho, D. A., Reis, V. M., van den Tillaar, R., Costa, A. M., Silva, A. J., Marques, M. C. (2010). Does combined dry land strength and aerobic training inhibit performance of young competitive swimmers? *Journal of Sports Science and Medicine*. 9(2): 300-310.

Jerszynski, D., Antosiak-Cyrak, K., Habiera, M., Wochna, K., Rostkowska, E. (2013). Changes in selected parameters of swimming technique in the back crawl and the front crawl in young novice swimmers. *Journal of Human Kinetics*. 37(1): 161-171.

Mujika, I. (1998). The influence of Training characteristics and Tapering on the Adaptation in Highly trained Individuals. *Int J Sports Med*. 19: 439-446.

Mujika, I., Chatard, J. C., Busso, T., Geysant, A., Barale, F., Lacoste, L. (1995). Effects of training on performance in competitive swimming. *Can. J. Appl. Physiol*. 20(4): 395-406.

Obert, P., Stecken, F., Courteix, D., Lecoq, A.-M., Guenon, P (1998.) Effect of long-term intensive endurance training on left ventricular structure and diastolic function in prepubertal children. *Int J Sports Med*. 19(2): 149-154.

Salo, D., Riewald, S. (2008). Complete Conditioning for Swimming. *Human Kinetics*

Sideraviciute, S., Gailiuniene, A., Visagurskiene, K., Vizbaraite, D. (2006). The effect of long-term swimming program on body composition, aerobic capacity and blood lipids in 14-19-year aged healthy girls and girls with type 1 diabetes mellitus. *Medicina (Kaunas, Lithuania)*. 42(8): 661-666.

Stransky, A.W., Mickelson, R.J., Van Fleet, C., Davis, R. (1979). Effects of a swimming training regimen on hematological, cardiorespiratory and body composition changes in young females. *Journal of Sports Medicine and Physical Fitness*. 19(4): Pages 347-354.

Volčanšek, B. (2002). Bit plivanja. *Udžbenici Sveučilišta u Zagrebu*.

Vrednovanje rada u nastavi tjelesne i zdravstvene kulture u primarnoj edukaciji

Marija Lorger¹, Kristina Kos², Ivan Prskalo¹

¹*Učiteljski fakultet, Sveučilište u Zagrebu, Hrvatska*

²*OŠ Rugvica, Hrvatska*

ABSTRACT

The aim was to explore ways of monitoring, assessment and grading in primary physical education. Monitoring, assessment and evaluation of the physical and health culture is a transformation process that encompasses all measurable characteristics, competencies, knowledge, achievement and educational variables, and assessment of actual progress of each student should have the dominant role. A research was carried out on a sample of 40 respondents from several different primary schools in Sisak and Zagreb. Anonymous questionnaire examined the attitudes of respondents on monitoring, checking and evaluation with emphasis on the elements and criteria involved in it. The results showed that the respondents sufficiently appreciate all the elements alike as well as criteria of assessment and marking. There was also a satisfying number of teachers in this study who have good cooperation with students and parents.

Keywords: kinesiological culture, monitoring students work, student, teacher

UVOD

Praćenje, provjeravanje i ocjenjivanje je nedjeljiv dio procesa nastave. Njegova provedba je vrlo odgovoran proces, a pomalo i stresan zadatak za svakog učitelja koji ovoj problematici pristupa odgovorno. Praćenje, provjeravanje i ocjenjivanje je proces vrednovanja usmjeren na procjenu dostizanja postavljenih ciljeva, zadataka nastave i učenja prema ranije utvrđenim

kriterijima. Praćenje, provjeravanje i ocjenjivanje pomaže učitelju u smislu saznanja o ostvarenju ranije postavljenih zadataka, odnosno približavanju učenika definiranom cilju i zadacima programa te njegovim efektima (Findak, 1992). Važnu ulogu u definiranju cilja zadataka programa imaju rezultati inicijalnog provjeravanja. Na temelju tih rezultata mogu se uočiti individualne razlike u različitim pokazateljima među učenicima kao kriterij dijagnoze stanja koja čini osnovu programiranja i kontinuiranog praćenja, provjeravanja i analize efekata programa vježbanja (Findak, 1992). Praćenje, provjeravanje rada i napredovanja učenika mora biti sustavno, realno i objektivno temeljeno na planu i programu rada i materijalnim uvjetima. Da bi se ispunile sve ove odrednice učitelj mora imati jasan cilj provjeravanja, što će omogućiti davanje povratne informacije učenicima o efektima njihova rada, ali i učiteljima o efikasnosti programa koji su primjenjivali tijekom nastavnog procesa (Findak, 1992). Također je sigurno da će i škola i roditelji od takvog pristupa imati koristi, škola u obliku kontinuiranog uvida u realizaciju programa, a roditelji u obliku pravodobne informiranosti i suradnje s učiteljem (Findak, 1992). Sadržaj praćenja i provjeravanja treba omogućiti učitelju cjelokupan i objektivni uvid u stanje antropološkog statusa učenika, izradu programa rada zasnovanog na potrebama učenika, mogućnost praćenja realizacije i dobivanja povratne informacije o efikasnosti programa. Učenicima sadržaji praćenja i provjeravanja trebaju dati povratnu informaciju o efikasnosti procesa vježbanja i efektima njihove angažiranosti tijekom realizacije programa (Findak, 1992). Praćenjem i provjeravanjem u kineziološkoj kulturi treba obuhvatiti zdravstveno stanje učenika, antropološka obilježja, motorička znanja, motorička dostignuća i odgojne efekte rada pri čemu je praćenje i provjeravanje pouzdanije ako je u njega uključen veći broj varijabli. Rezultate praćenja i provjeravanja moguće je iskazati u kvantitativnom obliku (bodovi, minute, sekunde...) i putem ocjene. Osim navedenog, poželjno je da učitelj „prati i provjerava“ učenika temeljem zabilješki, odnosno zapažanja o učenicima. Ocjenjivanje učenika podrazumijeva praćenje odgojno obrazovnog razvoja učenika na način utvrđen propisima i određivanje razine koju je postigao pri čemu se u kineziološkoj kulturi ne utvrđuje samo postupak realizacije cilja i programskih zadaća već i efekti programa. Ocjenjivanje treba na objektivni način kvalificirati uspjeh i napredak učenika te biti zasnovano na svestranom i stalnom praćenju i provjeravanju objektivnim mjerilima i uvažavanju individualnih razlika. Ocjena

treba odražavati konkretno stanje učenika, biti mjerilo njegove vrijednosti i odraz njegove ličnosti (Findak, 1992) pri čemu učitelj donosi prosudbe o radu, rezultatima i napretku učenika iz čega proizlazi da je ocjenjivanje vrlo važno, a uloga učitelja u tom procesu izuzetno odgovorna (Findak, 1992). Ocjenjivanjem treba obuhvatiti stanje zdravlja, antropološka obilježja, motorička znanja i motorička dostignuća i odgojne efekte rada. Telebar (2011) predlaže izradu modela vrednovanja motoričkih znanja za svaku nastavnu temu unutar nastavne cjeline službenog plana i programa kako bi ocjenjivanje bilo što objektivnije. Uloga učitelja u procesu ocjenjivanja je iznimno važna. Od učitelja se zahtjeva iznimna stručnost kako bi se u procesu ocjenjivanja izbjegla subjektivnost, odnosno kako bi se ocjenjivanje izvršilo strpljivo, objektivno i pravedno što podrazumijeva sagledavanje svakog učenika u cjelini sukladno svim informacijama s kojima raspolaže o nekom pojedincu. Da bi učenik bio aktivan subjekt procesa edukacije, sadržaje vježbanja treba maksimalno približiti autentičnim potrebama učenika jer je vježbanje individualni faktor, odnosno svaki onaj koji vježba čini to zbog sebe uz ulaganje osobnog napora i na način koji mu je najprimjereniji (Findak, 2011). Za praksu je izuzetno važno da raspolaže podacima o razini motoričkih znanja sudionika procesa edukacije zato što različite vježbe odgovaraju različitim ciljevima vježbanja i različitom stupnju usvojenosti kako bi individualizacija procesa motoričkog učenja i doziranje opterećenja bilo adekvatno (Findak, 2011). Miletić (2012) napominje da posebnu pozornost treba posvetiti razini motoričke informiranosti u smislu izbora motoričkih znanja koja će se primjenjivati u sustavnom procesu tjelesnog vježbanja, a koja će kasnije biti podvrgnuta procesu vrednovanja. Sukladno tome, Gallahue i Ozmun (2005) prema Miletić (2012) navode kako je od iznimne važnosti u kineziološkoj praksi kod djece pratiti razinu biotičkih motoričkih znanja zbog činjenice da nedovoljna razina temeljnih motoričkih znanja može negativno utjecati na usvajanje motoričkih znanja i motoričko izvođenje u kasnijem periodu života. U današnje vrijeme praćenje efekata realizacije programa uvelike može olakšati informatička tehnologija čiji su dijelovi programa prilagođeni upravo kineziološkoj edukaciji, odnosno nastavnom procesu (Božić, Tkalčec, Z., Tkalčec, M., 2012). Vrednovanje rada, odnosno praćenje, provjeravanje i posebno ocjenjivanje učenika u praksi najčešće odudara od predloženih modela na koji način bi trebalo vrednovati neko motoričko znanje. Sukladno tome uočava se veliki raskorak između

njihove usvojenosti i stvarnog stanja motoričkog znanja izraženo kroz ocjenu što se više uočava u višim razredima osnovne škole nego u primarnoj edukaciji (Štimec, B. i sur., 2012). S obzirom da je vrednovanje rada u nastavi kineziološke kulture izuzetno bitno kako za učenike, tako i za učitelja, cilj ovog rada je bio istražiti elemente i kriterije po kojima učitelji prate, provjeravaju i vrednuju rad učenika u nastavi kineziološke kulture u primarnoj edukaciji

METODE RADA

Istraživanje je provedeno na uzorku od 40 učitelja razredne nastave u osnovnim školama na području Grada Zagreba i Sisačko–moslavačke županije metodom anketnog upitnika. Sudjelovanje u istraživanju je bilo dragovoljno i anonimno. Uočena je polarizacija ispitanika s obzirom na radno iskustvo (manje od 5 godina., N = 15, 37%, više od 20 godina N = 12, 29%). Distribucija broja učitelja prema razredima u kojem predaju (od 1. do 4. razreda) je bila vrlo ujednačena.

REZULTATI I RASPRAVA

Tablica 1. Prikaz kontinuiranog praćenja zdravlja učenika te provođenja inicijalnog, tranzitivnog i finalnog provjeravanja

Broj ispitanika	Kontinuirano praćenje stanja zdravlja učenika	
40	DA – 34 (85%)	NE – 6 (15%)
Broj ispitanika	Provođenje inicijalnog provjeravanja	
40	DA – 37 (92%)	NE – 3 (8%)
Broj ispitanika	Provođenje tranzitivnog provjeravanja	
40	DA – 10 (25%)	NE – 30 (75%)
Broj ispitanika	Provođenje finalnog provjeravanja	
40	DA – 40 (100%)	NE – 0 (0%)

Iz prikazanih rezultata vidljivo je da se nedovoljna pozornost obraća na praćenje stanja zdravlja i na tranzitivno provjeravanje učenika. U praćenju zdravlja učenika ne smije biti kompromisa i svi učitelji ga moraju pratiti dok je tranzitivno provjeravanje važno zbog kontrole efikasnosti programa rada pa bi ga isto trebalo češće provoditi.

Tablica 2. Prikaz praćenja i provjeravanja antropološkog statusa učenika

Elementi antropološkog statusa				
Broj ispitanika	antropometrijske značajke	motoričke sposobnosti	funkcionalne sposobnosti	sve od navedenog
40	4 (8%)	8 (17%)	6 (12%)	30 (63%)

Iz rezultata prikazanih u gornjoj tablici uočava se da 63% učitelja (N = 30) koji su popunjavali anketni upitnik praćenjem i provjeravanjem obuhvaća čitav antropološki status učenika. Od ostalih (N=8) 17% učitelja prati motoričke sposobnosti, funkcionalne sposobnosti (N = 6) 12% te antropometrijske značajke (N= 4) 8%. S obzirom na nedostatan broj prikupljenih informacija, izostavljanje važnih varijabli mjerenja koje čine antropološki status program rada kod trećine ispitanih učitelja u ovom istraživanju ne može biti adekvatno planiran i ne može odgovoriti na potrebe učenika.

Tablica 3. Prikaz rezultata provođenja provjere motoričkih znanja i motoričkih postignuća pomoću motoričkih testova, te upoznatosti učenika i roditelja s elementima i kriterijima ocjenjivanja

Broj ispitanika	Provjera motoričkih znanja pomoću testova motoričkih znanja	
40	DA - 23 (57%)	NE - 17 (43%)
Broj ispitanika	Provjera motoričkih postignuća pomoću motoričkih testova	
40	DA - 25 (62%)	NE - 15 (38%)
Broj ispitanika	Upoznavanje učenika i roditelja s elementima i kriterijima ocjenjivanja	
40	DA - 37 (92%)	NE - 3 (8%)

Analiza podataka pokazuje kako 57% učitelja koji su sudjelovali u ovom istraživanju provjeru motoričkih znanja i postignuća vrši pomoću motoričkih testova. Od toga njih 43% ne izvodi takve testove sa svojim učenicima što je prilično visok postotak ispitanika. Broj ispitanika koji su upoznali učenike i roditelje s elementima i kriterijima ocjenjivanja u nastavi tjelesne i zdravstvene kulture iznosi visokih 92%. U 8% slučajeva ni učenici ni roditelji nisu bili upoznati s elementima i kriterijima ocjenjivanja što se može pripisati slaboj suradnji učitelja i roditelja te posebnim uvjetima rada (dislocirana manja područna škola).

Bez obzira na sve zapreke, učitelji uvijek trebaju težiti poboljšanju komunikacije s roditeljima jer to može biti od ključne važnosti za daljnji razvoj učenika. Nedovoljnom komunikacijom ne samo da se dovodi u pitanje uspjeh učenika nego se mogu izostaviti i bitni čimbenici poput stanja zdravlja učenika i sl.

Tablica 4. Prikaz rezultata sastavnica uključenih u procjenu odgojnih učinaka rada

Procjena odgojnih učinaka rada						
Broj ispitanika	aktivnosti učenika u nastavi	sudjelovanje u izvannastavnim aktivnostima	stečene zdravstveno-higijenske navike	usvojenost teorijskih znanja	sve od navedenog	
40	14 (25%)	3 (6%)	11 (20%)	2 (4%)	25 (45%)	
Načela ocjenjivanja pri formiranju objektivnog odraza rada i napretka učenika						
Broj ispitanika	načelo individualnosti	načelo svestranosti	načelo sustavnosti	načelo realnosti	načelo pravednosti	načelo javnosti
40	15 (23%)	10 (17%)	12 (20%)	6 (12%)	8 (14%)	8 (14%)

Odgojne učinke rada provjerava 45% ispitanika (N=25) pomoću svih navedenih elemenata. Najveću pozornost pridodaju aktivnosti na nastavi 25% (N=14) i stečenim zdravstveno-higijenskim navikama 20% (N=11) što je poželjno i uobičajeno. Ipak veću važnost treba dati i sudjelovanju učenika u izvannastavnim aktivnostima jer to traži od učenika i veću angažiranost i nakon obveznog sata kineziološke kulture. Učitelji u svrhu formiranja objektivnog odraza rada i napretka učenika najčešće koriste načelo individualnosti 23% (N=15) zatim slijedi načelo sustavnosti 20% (N=12), te načelo svestranosti 17% (N=10) dok su načela pravednosti, javnosti i realnosti manje zastupljena. Vrlo je vjerojatno da učitelji iz ove skupine ispitanika možda imaju neka „svoja specifična načela“ ocjenjivanja što je doprinijelo ovako „šarenom“ rezultatu, ali bi bilo poželjno da se u većoj mjeri koriste i „službenim“ načelima.

ZAKLJUČAK

Svrha rada bila je istraživanje elemenata praćenja, provjeravanja i ocjenjivanja u nastavi tjelesne i zdravstvene kulture od 1. do 4. razreda. Za potrebe istraživanja korišten je anonimni anketni upitnik od 9 čestica koje su sadržavale sastavnice i kriterije praćenja, provjeravanja i ocjenjivanja u nastavi tjelesne i zdravstvene kulture. Analiza rezultata pokazala je uglavnom zadovoljavajuću učestalost korištenja elemenata praćenja, provjeravanja i ocjenjivanja iako aspekt praćenja zdravstvenog stanja učenika mora biti u potpunosti zadovoljen jer je to temeljni uvjet da bi se učenici uopće mogli baviti tjelesnom aktivnošću. Učitelji više pažnje predaju inicijalnom i finalnom nego tranzitivnom provjeravanju, dok mali broj učitelja zanemaruje mjerenje antropometrijskih obilježja. Motorička znanja i postignuća prate se redovito, a 65% ispitanika procjenjuje i odgojne učinke rada, pri čemu dominiraju varijable aktivnosti u nastavi i sudjelovanja u izvannastavnim aktivnostima. Velika većina ispitanih (92%) ima dobru suradnju s učenicima i roditeljima. Može se stoga zaključiti da većina sudionika ovog istraživanja kontinuiranim praćenjem rada i uvažavanjem načela ocjenjivanja doprinosi napretku učenika u razumjevanju nastavnog procesa, kao i boljoj suradnji učenika, roditelja i učitelja, ali i da i dalje trebaju raditi na unapređivanju načina vrednovanja rada.

LITERATURA

Božić, D., Tkalčec, Z., Tkalčec, M. (2012). Praćenje motoričkih sposobnosti učenika razredne nastave. U V. Findak (Ur.) *Zbornik radova 21 ljetne škole kineziologa „Intenzifikacija procesa vježbanja u područjima edukacije, sporta, sportske rekreacije i kineziterapije“ Poreč* (str. 371 – 377). Zagreb: Hrvatski kineziološki savez

Findak, V. (2011). Kineziološko motrište na obrazovnu dijagnostiku. U V. Findak

(Ur.) *Zbornik radova 20 ljetne škole kineziologa „Dijagnostika u područjima edukacije, sporta, sportske rekreacije i kineziterapije“ Poreč* (str. 287 - 290) Zagreb: Hrvatski kineziološki savez

Findak, V. (2003). *Metodika tjelesne i zdravstvene kulture - priručnik za nastavnike*

tjelesne i zdravstvene kulture. Zagreb: Školska knjiga

Findak, V. (1992). *Metodika tjelesne i zdravstvene kulture. Priručnik za nastavnike razredne nastave*. Zagreb: Školska knjiga

Štimec, B., Hublin, T., Rajner, J., Štimec, R., Pavlec, N., Cesarec, R. (2012).

Provjeravanje efekata učenja motoričkog znanja kod učenika prvih razreda s ciljem intenzifikacije nastavnog procesa. U V. Findak (Ur.) *Zbornik radova 21 ljetne škole kineziologa „Intenzifikacija procesa vježbanja u područjima edukacije, sporta, sportske rekreacije i kineziterapije“ Poreč* (str. 338 - 342) Zagreb: Hrvatski kineziološki savez

Štimec, B., Štimec, R., Pavlec, N., Cesarec, R. (2011). Provjeravanje motoričkog znanja kod učenika prvih razreda. U V. Findak (Ur.) *Zbornik radova 20 ljetne škole kineziologa „Dijagnostika u područjima edukacije, sporta, sportske rekreacije i kineziterapije“ Poreč* (str. 505-510) Zagreb: Hrvatski kineziološki savez

Telebar, B. (2011). Primjer modela vrednovanja motoričkih znanja u drugom razredu

srednje škole. U V. Findak (Ur.) *Zbornik radova 20 ljetne škole kineziologa „Dijagnostika u područjima edukacije, sporta, sportske rekreacije i kineziterapije“ Poreč* (str. 520 -524) Zagreb: Hrvatski kineziološki savez

Differences in anthropometric characteristics and general motor abilities between female volleyball players and untrained girls 17 years old

Goran Nešić, Nikola Majstorović

Faculty of sport and physical education, University of Belgrade, Serbia

ABSTRACT

Physical development and improvement of motor skills are significant components that can be influenced through programmed physical practice. The subject of this research was comparative analysis of anthropometric characteristics and general motor abilities of female volleyball players and untrained girls of the same age. The aim of the study was to measure anthropometric characteristics and asses certain general motor abilities of female volleyball players in comparison to untrained girls of the same age. We hypothesized that there are statistically significant differences between volleyball players and untrained girls 17 years old in all measured variables. Sample of subjects was obtained from population of middle school students from the territory of Belgrade. It consisted of 62 students 17 years \pm 6 months old with subsamples of 32 volleyball players and 32 untrained girls. Comparative analysis showed that statistically significant differences (Sig.<.05) exist in all variables of motoric area, but not in any of the measured antropometric characteristics. Volleyball practise leads to improvement of versatile motor abilities, which was shown by motor abilities tests where volleyball players had statistically better results then untrained girls.

KEYWORDS: volleyball, girls, motor abilities

INTRODUCTION

Sport and physical activity play an important role in all areas of life. Physical activity has a positive effect on healthy life style adoption, improves health and general life quality. Physical development and improvement of motor

skills are significant components that can be influenced through programmed physical practice (Bompa, 2005). It is impossible to account for all positive effects of physical activity, but without a doubt some of them are: life quality and health improvement, prolonging expected life duration and decreases risk of chronic noninfectious diseases such as cardiovascular problems, diabetes, malignant diseases etc. (Smith, Ekelund, Hamer, 2015). Motor abilities of children and young people are affected by different structural features who define it as a bio-psycho-socially integrated self. In order for versatile development of motor potentials to be achieved, it is necessary to know the elements on which we can have an impact and who are crucial for realization of body activities. In basis of physical activity there are a large number of physiological and metabolic processes. Body, activated by physical activity reacts with change in almost all physiological systems (Ugarković, 2001). Physical education contributes in a unique way to learning process, personal growth and health of students. It is mandatory in almost 90% of world countries. All students have the right to physical education which promotes broad physical competency and introduction to physical activity, growth and development, understanding of healthy life style importance, self respect in context of physical activity, interpersonal skills, as well as whole life interests and engagement in physical activity. Given the fact that physical education isn't adequately represented with the curriculum number of classes, class approach is being achieved with low energy component, which presents a big problem in program content realization. There is an increasing number of kids being included in sports clubs or school sections training processes. Sports importance is enhanced in the modern days life conditions. It will advance and grow, not only under the influence of hypokineses awareness, brought by the modern lifestyle, but also from the need for youth to be "involved", recruited in its spare time (Stojanović, Kostić, Nešić, 2005.). Given the fact that the game of volleyball demands certain level of anthropological features in order for volleyball players to successfully act in situational conditions, and that in science interdisciplinary approach makes a fundamental methodological orientation, subject of sciences in the area of sport is anthropological status. The subject of this research was comparative analysis of anthropometric characteristics and general motor abilities of female volleyball players and untrained girls of the same age. The aim of the study was to measure anthropometric characteristics and asses certain general motor abilities of female volleyball players in comparison to untrained girls of the same age. We hypothesized that there are statistically significant differences between volleyball players and untrained girls 17 years old in all measured variables.

METHOD

“Ex-post facto”, quasi-experimental approach type of research was used in this study, and the type was transversal. Obtained data was analyzed with data analysis software (SPSS 19.0). From the descriptive statistics area parameters were calculated for both groups of subjects and for every variable separately. Calculated parameters were: minimal (MIN), maximal (MAX) and arithmetic mean value (MEAN), standard deviation (STDEV), variation coefficient (CV%), Skewness and Kurtosis. Independent samples t-test was used for comparative analysis, and the critical value was $p=.05$. Available literature, knowledge gained at Faculty of sport and physical education, as well as valuable information from experienced experts, was used for qualitative analysis.

Measurement was conducted at Faculty of sport and physical education in Belgrade in second week of 2014/2015 school year. Testing protocol was the same for all of the participants.

Sample of subjects was obtained from population of middle school students from the territory of Belgrade. It consisted of 64 students 17 years \pm 6 months old. Subjects were divided into two subsamples:

- Subsample of 32 students, members of VT „Lucky star“ from Belgrade, and who were practising volleyball for at least two years, 5 times a week. They were all regular students, and didn't have more than 30% absence from physical education classes.
- Subsample of 32 students of „Građevinska škola“ from Belgrade, who were all regular students, and didn't have more than 30% absence from physical education classes.

Sample of variables, their abbreviations, which will be used in further text, are listed in Table 1.

	Variable	Test
BM	Body mass	Measurement of mass with beam scale
BH	Body height	Height measurement with anthropometer by Martin
BMI	Body-mass index	Calculation: TM/TV^2
SR	Aerobic endurance	„Shuttle run“
T20	Movement speed	20 meter high start run
X	Agility	„X“ test
SR	Power of leg extensors	“Sargent” test
SJ	Power of leg extensors	Standing long jump
MB	Power of arm muscles	Medicine ball throw

Tests, and measurement instruments will be described in further text.

Body mass – beam scale (Tanita Body Inner Scan, BC – 601).

Body height – Anthropometer by Martin.

Body-mass index – calculated with formula BM/BH^2 .

“Shuttle run” – one of the tests for aerobic abilities which are based on maximal oxygen consumption. This is a test of multilevel progressive load by repetitive 20 meter runs.

20 meter high start run – a test for movement speed assessment. Subject is in a high start position on the starting line. Commands are: get ready, set, and a whistle sound means go. When he hears the sound the subject runs as fast as he can to the finish line.

“X” test – test for assessment of agility. Pins are placed as shown in the picture (Picture 1.), and the subject is located at the center pin. After the signal given by the measurer subject seeks to cover the distance marked on the picture in the shortest amount of time.

Picture 1. “X” test (taken from Sikimić, 2013)

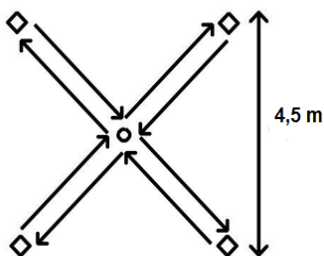

Sargent test – stance shoulder width apart, hip towards the wall with fixed centimeter tape. Subject, with the hand closer to the wall, reaches as high as he can. After that he jumps with the arms swing and tries to reach the highest point he can. Jump must be performed with both legs. Two jumps were made, and only the better one was recorded. The difference between the reach point and the jump reach point was calculated to obtain the jump height.

Standing long jump – test for assessment of leg extensors explosive strength. Measurement was done in accordance with the protocol described by Nešić et al., 2013.

Medicine ball throw – test for upper body strength. Measurement was done in accordance with the protocol described by Višnjčić, Jovanović, Miletić, 2004.

RESULTS

Descriptive statistics for both groups are shown in Table 2. and Table 3.

Table 2. Descriptive statistics for the sample of volley players

Descriptive Statistics ^a					
Variable	N	Min ÷ Max	Mean±(StDev.)	Skewness	Kurtosis
Age	32	17 ÷ 17	17±(0)		
BM (kg)	32	48 ÷ 93	66.84±(9.02)	0.37	1.31
BH (m)	32	1.61 ÷ 1.86	1.73±(0.06)	-0.19	-0.05
BMI	32	16.6 ÷ 29.68	22.41±(2.82)	0.07	0.49
SR (s)	32	205 ÷ 309	265.63±(28.7)	-0.24	-1.05
T20 (s)	32	2.37 ÷ 3.38	2.78±(0.32)	0.44	-1.21
X (s)	32	9.67 ÷ 14.47	10.63±(0.93)	2.46	8.71
SR (cm)	32	27 ÷ 51	38.34±(4.8)	0.07	0.90
SJ (m)	32	1.55 ÷ 2.2	1.81±(0.16)	0.10	-0.36
MB (m)	32	4.4 ÷ 6.1	5.51±(0.34)	-0.67	2.50

Table 3. Descriptive indicators for the sample of untrained girls

Descriptive Statistics ^a					
Variable	N	Min ÷ Max	Mean±(StDev.)	Skewness	Kurtosis
Age	32	17 ÷ 17	17±(0)		
BM (kg)	32	47 ÷ 86	63.5±(10.17)	0.57	-0.48
BH (m)	32	1.586 ÷ 1.826	1.7±(0.06)	0.14	-0.27
BMI	32	17.57 ÷ 29.03	22.63±(3.37)	0.39	-1.05
SR (s)	32	130 ÷ 291	208.75±(46.55)	0.31	-1.02
T20 (s)	32	2.78 ÷ 3.98	3.36±(0.27)	0.00	-0.12
X (s)	32	11.5 ÷ 17.62	13.84±(1.46)	0.53	0.26
SR (cm)	32	17 ÷ 36	27.66±(4.61)	-0.09	-0.38
SJ (m)	32	1.25 ÷ 2.15	1.58±(0.23)	0.91	0.30
MB (m)	32	2.48 ÷ 5.5	4.28±(0.8)	-0.73	-0.02

Results of independent samples t-test are shown in Table 4. with data about mean difference, standard error difference, t-value and significance of the difference (Sig.)

Table 4. Comparative analysis of differences between volleyball players and untrained girls

Independent Samples Test			
t-test for Equality of Means			
Variables	Mean Difference	t	Sig. (2-tailed)
AGE	3.34	1.39	.169
BM	0.02	1.59	.118
BH	-0.22	-0.28	.778
BMI	56.88	5.88	.000*
SR	-0.58	-7.90	.000*
T20	-3.21	-10.47	.000*
X	10.69	9.09	.000*
SR	0.23	4.60	.000*
SJ	1.24	8.05	.000*

DISCUSSION

In Table 2. and 3. in which descriptive indicators are shown for both samples there are results of minimum to maximum range, mean difference for every single test. Standard deviation and coefficient of variation values obtained from sample of volleyball players in comparison to untrained girls are lower in almost every test. This indicates the fact that the volleyball players sample had more homogenous results in measured test, their results were less dispersed. Results of distribution measures are as follows: in volleyball players sample, 6 of 9, and in untrained girls sample, 7 of 9 tests show positive values of Skewness which indicate positive asymmetry². Results of distribution measure Kurtosis are equally allocated over and under zero, while untrained girls had 7 of 9 tests with negative values, which indicates flattened distribution³.

In Table 4. Comparative statistics results are shown and based on the data it is established that statistically significant differences (Sig.<.05) exist in all variables of motoric area, but not in any of the measured antropometric characteristics. Mean difference between volleyball players and untrained girls in body mass is 3.34kg in favour of volleyball players, and it is not statistically

² Positive asymmetry presents the kind of dispersion in which there is a higher representation of results under average.

³ Flattened distribution indicates dispersion in which there is a large range of results on both sides of the average.

significant (Sig.=.169). Results of body height measurement didn't show statistically significant difference between two subsamples (Sig.=.118) with mean difference of 2cm in favour of volleyball players. Obtained results differ from the previous research (Nešić, et al. 2014) and practical expectations, that the appropriate selection process, given the specificity of volleyball game, will have an impact on volleyball players height. In this situation selection obviously wasn't conducted as expected, which resulted in volleyball players not being higher than untrained girls of the same age. The fact that differences in body dimensions don't exist contributes to an increase of inner validity in motor abilities testing, given that it is familiar that certain differences in skeleton longitudinality can contribute to better results in tests: high jump, tests for speed assessment and agility.

Motor area variables show that statistically significant differences between volleyball players and untrained girls 17 years old exist in all measured tests. In Shuttle run test volleyball players have achieved statistically significantly better results (Sig.<.000). Volleyball game structure implies interval loads of high as well as moderate intensity which alternate with brakes between points (Nešić, 2006.). This kind of effort demands aerobic, as well as anaerobic endurance, so it is expected that volleyball training will have a positive impact on the development of those abilities in comparison to untrained girls who didn't have this kind of positive influence. In speed and agility tests (20m run, and X-test) volleyball players also had statistically significantly better results, with the level of significance of Sig.=.000. Even though speed isn't a crucial ability in volleyball, the capacity to accelerate is essential. As strong as the athlete is, the acceleration also increases. Better volleyball players are capable of accelerating from a standstill to full speed in just a few steps. Volleyball is also a sport of deceleration, where the ability to stop, and quickly change direction is one of the characteristics of top volleyball players (Foran, 2010). Differences in favour of volleyball players in strength of leg extensors (Standing long jump, Sargent) are also the consequence of volleyball game, which demands a large number of jumps and sudden direction changes. They contribute to development of leg extensor muscles and their expression in the form of vertical and horizontal jumps. Medicine ball throw test implies movement which, in a kinematic sense, resembles a lot with a movement prior to volleyball spike. Large number of spikes in practice and games implies that muscles involved in the movement will improve. That improvement on account of volleyball practice led to accuracy of statistically significant differences (Sig.<.000) between volleyball players

and untrained girls in the medicine ball throw test. All those characteristics are developed by specific and unspecific volleyball practise. Capabilities that these tests assess are extremely important in a volleyball game and as such they receive extra attention, both in the planning of training, as well as in the selection.

CONCLUSION

The aim of this study is to determine whether there are statistically significant differences between volleyball players and untrained girls of the same age. Results of independent t-test lead to a conclusion that, volleyball players in comparison to untrained girls, have statistically significantly more developed motor abilities. Nature and structure of physical activity those two groups are engaged in explain the occurred differences. Physical education classes, attended by the untrained subsample, is directed to a mild but constant motor abilities development (or maintenance, to be more specific) and a habit to exercise, while volleyball training is more specific and intense in the sense of development of motor abilities which are key to achieving better results in competition (Gortsila, et al. 2013). Locomotions manifested during a volleyball practise are in both horizontal and vertical plain, there are a lot of sudden changes of direction (forward-backward and sideways runs), which fit the pattern of agility, and definitely contribute to leg extensors explosive strength development, in both plains. All this significantly affects the further improvement of versatile motor abilities, which was shown by motor abilities tests where volleyball players had statistically better results than untrained girls. Variables of body dimensions and body mass are not statistically significantly different which argues that proper selection process was not executed, given the fact that it is known how important longitudinal body measurements are in the game of volleyball. A large number of coaches signifies motor abilities development monitoring, and knowing that these results can be of use as sort of a model for training process improvement.

NOTE

This study was a part of the project no. III47015 Effects of the Applied Physical Activity to Locomotor, Metabolic, Psycho-Social and Educational Status of the Population of the Republic of Serbia as a part of the sub-project Effects of the Applied Physical Activity to Locomotor, Metabolic, Psycho-

Social and Educational Status of the Athletes Population of the Republic of Serbia funded by the Ministry of Science and Technology Development of the Republic of Serbia – Scientific projects cycle 2011-2015.

REFERENCES

- Bompa, T. (2005). *Whole training for young*. Zagreb. Gopal.
- Foran, B. (2001). *High performance sports training*. Champaign, IL. Human kinetics.
- Gortsila, E., Theos, A., Nešić, G. and Maridaki, M. (2013). Effect of Training Surface on Agility and Passing Skills of Prepubescent Female Volleyball Players. *Journal of Sports Medicine and Doping Studies* 3, issue 2, pp. 1-5.
- Višnjić, D., Jovanović, A., Miletić, K. (2004). *Theory and methods in physical education*. Belgrade. Faculty of sport and physical education.
- Smith, L., Ekelund, U., Hamer, M. (2015). The Potential Yield of Non-Exercise Physical Activity Energy Expenditure in Public Health. *Sports Medicine* 45, issue 4, pp 449-452.
- Nešić, G. (2006). Structure of competitive activity in women's volleyball. (Doctoral thesis). Faculty of sport and physical education. Belgrade.
- Nešić, G., Ilić, D., Majstorović, N., Grbić, V. i Osmankač, N. (2013). Effects of training on general and specific motor abilities of volleyball players 13-14 years old. *SportLogia* 9, issue 2, pp. 119-127.
- Nešić, G., Majstorović, N., Sikimić, M., Marković, S., Ilić, D., Grbić, V., Savić, Z. (2014). Anthropometric characteristics and motor abilities in 13-15 years old female volleyball players. *Facta Univeristatis*, 12, issue 3, pp. 327-339.
- Sikimić, M., Dopsaj, M., Majstorović, N., Majstorović, N. Nešić, G. (2013). Basic metrological characteristics of the modified agility tests at female volleyball players - T test, Jelka test and X test. Conference proceedings: *Physical education and modern society*, pp.46. Jagodina. Faculty of pedagogical sciences.
- Stojanović, T., Kostić, R., Nešić, G. (2005). *Vollezbball*. Faculty of physical education and sport. Banja Luka.
- Ugarković, D. (2001.) *Sports medicine basics* (4th. supplemented and remanufactured edition). Basketball high school. Belgrade

Relacije između kineziološke angažiranosti, Psiholoških obilježja i tipova korištenja Televizije adolescenata

Luka Pezelj¹, Boris Milavić¹, Toni Gamulin¹, Petra Sinovčić², Zorana Šesnić¹

¹*Kineziološki fakultet, Sveučilište u Splitu, Hrvatska*

²*Odjel za sociologiju, Sveučilište u Zadru, Hrvatska*

ABSTRACT

The aim of this study was to determine the relations of types of the adolescent's TV users with their kinesiology activity and some psychological characteristics. The study was conducted on 601 students of seventh and eighth grade elementary schools in Split-Dalmatian and Sebenic-Knin counties. The set of measured variables was consisted of variables: kinesiology engagement, perceived sport competence, and variables of general, physical health and body-image self-esteem. Three new scales of television usage were constructed: scale of general usage of television, scale of television usage for entertainment, and scale of television usage for sports watching. Boys had higher scores of perceived sport competence (general and specific), kinesiology engagement, and body-image self. Girls had higher scores of their general self and physical health image. Girls more than boys use TV for general purposes, but also for watching an entertainment contents. Boys via television monitor more sports contents than girls. Based on three measurements of adolescents television usage all subjects were divided into three types of television users: highly active, intermediate active and low active user type. Girls usually (48% of them) belong to a highly active type of television users because they very much and frequently watch television, but do not follow sports on TV. Boys were mostly (60%) members of the active type of television usage, because they often watch television, but usually monitor a TV sporting events. Different types of television users differ in the amount of their kinesiological engagement and psychological characteristics. A group of intermediate active female TV

users is characterized by their high perceived sport competence (general and specific) and kinesiology engagement, with slightly higher general self-esteem measure in the other two types of television users. A group of intermediate active male TV users is characterized by their high perceived sport competence (general and specific) and kinesiology engagement, while the other two types of users were characterized by higher physical health image

Keywords: sedentary behaviour, psychological characteristics, TV usage, students

UVOD

Tjelesna aktivnost u pogledu tjelesnog zdravlja ima važnu ulogu u jačanju mišićne mase, očuvanju koštane mase i zadržavanju spretnosti. Sedentarna ponašanja negativno utječu na pojavu, progresiju i oporavak od različitih metaboličkih poremećaja i bolesti kardiovaskularnog sustava, dok programirana, redovita i planirana tjelesna aktivnost omogućuje smanjenje rizika za nastanak navedenih problema. Napredak u razvoju tehnologije dovodi do sve manje potrebe za tjelesnom aktivnosti, unatoč potvrđenoj činjenici da je za održavanje zdravlja i sprječavanja razvoja kroničnih bolesti tjelesna aktivnost neophodna. Svakodnevno se sve više naglašava važnost i potreba aktivnog životnog stila s redovnom tjelesnom aktivnošću tijekom djetinjstva, adolescencije i kasnije u odrasloj dobi, a radi očuvanja zdravlja, dobrobiti pojedinca, ali i čitave populacije (Breslauer, 2008). Kontinuirano opadanje kineziološke aktivnosti mladih nalazi se upravo u sve većoj tehnizaciji i informatizaciji društva (Kautiainen i sur., 2005) jer današnji adolescenti puno vremena provode koristeći neke od dostupnih tehnoloških sprava. Nacionalna istraživanja ukazuju na sve veći broj pretilih adolescenata. Načine korištenja tehnoloških sprava moguće je vidjeti u istraživanjima korištenja uporabe mobitela i računala. Milić i sur. (2014) istraživali su relacije korištenje mobitela i računala s kineziološkom aktivnošću i nekim psihološkim obilježjima adolescenata. Učenice i učenici se značajno razlikuju po stupnju korištenja mobitela i računala u različite svrhe, ali se ne razlikuju po učestalosti pripadnosti pojedinom tipu korisnika mobitela računala. I kod učenica i kod učenika, tipovi korisnika mobitela i računala se značajno razlikuju po skupu izmjerenih varijabli. Tipovi *visoko aktivnih* korisnika mobitela i računala imaju značajno viši stupanj *pasivne zaokupljenosti sportom*, a kod učenika

imaju još nešto više izraženu *percipiranu sportsku kompetenciju* i *kineziološku angažiranost*. Madden i sur. (2013) navode činjenice o korištenju mobilnih telefona američkih adolescenata dobi između 12 do 17 godina: više od trećine adolescenata (37%) posjeduje *smarthphone* («pametni» mobilni telefon) ili neki drugi uređaj za «mobilni» Internet, 78% ih posjeduje mobitel, 74% adolescenata barem povremeno pristupa Internetu preko nekog od mobilnih uređaja; te djevojčice značajno više od dječaka pristupaju Internetu preko svojih mobilnih telefona. Milavić i sur. (2012) opisali su tri različita tipa korisnika računala kod adolescenata, a učenice i učenici se razlikuju po učestalosti pripadnosti pojedinom tipu korisnika računala. Viši postotak učenica pripada tipu *visoko aktivnih* korisnika računala. Na uzorku učenika su utvrdili kako se različiti tipovi korisnika računala značajno razlikuju po skupu izmjerenih varijabli psiholoških obilježja pa tip *visoko aktivnih* korisnika računala ima značajno viši stupanj *pasivne* i *aktivne zaokupljenosti sportom*, *percipirane sportske kompetencije*, uz značajno niži stupanj *percipirane slike o svom zdravlju* od drugih dvaju tipova. Milić i sur. (2011) utvrdili su kako između učenica i učenika završnih razreda osnovne škole postoje značajne razlike te učenici pokazuju značajno višu *pasivnu zaokupljenost sportom*, *kineziološku angažiranost* i stupanj *specifične percipirane sportske kompetencije* od učenica. Televizija je kao medij dugo vremena dostupan većini mladih te ga oni koriste za praćenje različitih sadržaja: informativnih, zabavnih, glazbenih, filmskih, sportskih, nastavnih i slično. Istražujući navike gledanja televizije kod adolescenata između 1986. i 2002., Samdal i sur. (2006) su utvrdili kako dječaci češće gledaju TV od djevojčica, ali nisu utvrdili jasne obrasce promjena u adolescentskom gledanju TV tijekom tog razdoblja. U istraživanju o načinu provođenja slobodnog vremena studenata utvrđeno je da studentice, njih 69,1%, najviše vremena posvećuju gledanju televizijskih programa, dok je tek svaka četvrta studentica tjelesno aktivna (Andrijašević i sur., 2005.). Cilj ovog istraživanja je konstruirati kvalitetne ljestvice korištenja televizije kojima bi se među adolescentima kvalitetnije definirali različiti tipovi korisnika televizije te utvrditi relacije između kineziološke angažiranosti i psiholoških varijabli (opća i specifična PSK, opće samopoimanje, slika o tijelu te slika o svom zdravlju) u odnosu na različite tipove korištenja televizije učenika završnih razreda osnovne škole.

METODE RADA

Uzorak ispitanika sastavljen je od 601 učenica i učenika 7. i 8. razreda osnovnih škola iz splitsko-dalmatinske i šibensko-kninske županije, bez izraženog strukturalnog deformiteta koji bi limitirao njihovo bavljenje sportom.

Od toga je bilo 289 učenice i 312 učenika. Skup mjerenih varijabli sačinjavale su varijable ljestvica *kineziološke angažiranosti (KINZ_ANG)* (Milić, Grgantov i Milavić, 2011), varijable *opće (OPCA_PSK)* i *specifične (SPEC_PSK) percipirane kompetencije za sport* (Milavić, Guć i Miletić, 2010), varijable *općeg (SELF_EST)* i *tjelesnog (BODY_IMG) samopoimanja* (Samardžić, Bego i Milavić, 2011) te varijabla *percepcije slike učenika o svom zdravlju (ZDRV_IMG)* (Milavić i sur., 2012). Za utvrđivanje stupnja korištenja televizora konstruirane su tri nove ljestvice: ljestvica *općeg korištenja televizije (TV__OPCE)*, ljestvica *korištenja televizije za zabavu (TV_ZABAV)* te ljestvica *korištenja televizije za praćenje sporta (TV_SPORT)*. Ovim se ljestvicama utvrđuje preferencija, ali i izraženost pojedinih oblika korištenja televizije adolescenata, kao značajnog oblika njihovih sedentarnih ponašanja. Od statističkih postupaka korišteni su postupci za utvrđivanje osnovnih metrijskih značajki novih ljestvica, postupci za utvrđivanje razlika između skupina adolescenata po spolu (t-test), taksonomska analiza (*K-means clustering*) za određivanje tipova korištenja televizije te diskriminacijska analiza u cilju utvrđivanja razlika mjernih varijabli kineziološke angažiranosti i samopoimanja između različitih tipova korisnika televizije. Rezultati svih ljestvica dobiveni su na način da se rezultati svih čestica pojedine ljestvica zbroje i podijele s ukupnim brojem čestica iste ljestvice, kako bi se mogli uspoređivati rezultati dobiveni na ljestvicama s različitim brojem čestica.

REZULTATI

Tablica 1. Metrijske karakteristike konstruiranih i validiranih ljestvica

VAR	BROJ ČESTICA	CRONBACH ALFA	AS	SD	D* (K-S test)	SKEW	KURT
OPĆA_SP_KOMP	10	0,89	3,39	0,87	0,055*	-0,23	-0,42
SPEC_SP_KOMP	9	0,85	3,16	0,85	0,041	-0,16	-0,46
KINEZ_ANGAŽIR	10	0,91	3,08	1,13	0,084*	-0,14	-1,13
SAMOPOIMANJE	7	0,67	3,38	0,74	0,058*	-0,06	-0,47
SLIKA_TIJELO	6	0,78	3,64	1,01	0,104*	-0,50	-0,44
SLIKA_ZDRAVLJE	7	0,83	3,68	0,92	0,093*	-0,59	-0,23
TV__OPĆE	5	0,73	3,78	0,93	0,096*	-0,32	-0,45
TV_ZABAVA	5	0,66	3,37	0,92	0,075*	-0,19	-1,18
TV_SPORT	5	0,90	3,16	1,26	0,091*	-0,23	-0,42

Legenda: CRONBACH ALFA – koeficijent internalne konzistencije; AD – aritmetička sredina; SD – standardna devijacija; D – koeficijent K-S testa; * - oznaka značajnosti koeficijenta K-S testa; SKEW – mjera simetričnosti distribucije; KURT – mjera oblika distribucije.

Sve izmjerene varijable imaju kvalitetne mjerne karakteristike (pouzdanost, homogenost i osjetljivost) za provedbu mjerenja. Koeficijenti pouzdanosti iznose od dovoljnih 0.66 za ljestvicu *korištenja televizije za zabavu* do visokih 0.91 za *kineziološku angažiranost*. Pouzdanosti validiranih ljestvica slične su onima pri njihovoj konstrukciji (Milavić i sur., 2012; Milić i sur., 2010). Za svaku ljestvicu potvrđena je zadovoljavajuća homogenost jer su sve čestice projicirale na jednu latentnu dimenziju. Za većinu ljestvica utvrđeno je kako distribucija rezultata odstupa značajno od normalne distribucije, ali su ostali pokazatelji oblika i simetričnosti distribucije zadovoljavajući, što omogućuje primjenu parametrijskih statističkih postupaka obrade rezultata.

Tablica 2. Deskriptivna statistika i značajnost razlika korištenja televizije po spolu

VAR	DJEČACI		DJEVOJČICE		t-test	p
	AS	SD	AS	SD		
OPĆA_SP_KOMP	3,51	0,86	3,26	0,86	3,56***	0,000
SPEC_SP_KOMP	3,33	0,84	2,97	0,82	5,40***	0,000
KINEZ_AN_GAŽIR	3,28	1,06	2,88	1,18	4,39***	0,000
SAMO-POIMANJE	3,28	0,74	3,48	0,72	3,27***	0,001
SLIKA_TI-JELO	3,78	0,93	3,50	1,07	3,41***	0,001
SLIKA_ZDRAVLJE	3,50	0,97	3,88	0,82	5,16***	0,000
TV__OPĆE	3,61	0,93	3,96	0,90	4,58***	0,000
TV_ZABAVA	3,17	0,92	3,58	0,88	5,45***	0,000
TV_SPORT	3,62	1,12	2,67	1,22	9,89***	0,000

Legenda: AS – aritmetička sredina; SD – standardna devijacija; t-test – koeficijent t-testa; p = - razina značajnosti koeficijenta t-testa; *** - razina značajnosti koeficijenta od $p < .001$.

Između učenika i učenica utvrđene su značajne razlike za sve mjerene varijable. Dječaci imaju značajno višu *opću i specifičnu percipiranu sportsku kompetenciju*, višu *kineziološku angažiranost i pasivnu zaokupljenost sportom*, kao i višu procjenu *slike o tijelu* te nižu procjenu *općeg samopoimanja i svoje percepcije zdravlja* od učenica. Učenica više koriste televiziju za zabavu i opće potrebe, a manje za svoje praćenje sportskih sadržaja od učenika.

Tablica 3. Deskriptivne vrijednosti tipova korištenja televizije učenika i učenika

VAR	TIP 1 (N=155)		TIP 2 (N=280)		TIP 3 (N=166)	
	AS	SD	AS	SD	AS	SD
TV__OPĆE	2,75	0,74	3,99	0,74	4,39	0,55
TV_ZABAVA	2,51	0,71	3,59	0,81	3,79	0,76
TV_SPORT	2,52	0,91	4,26	0,56	1,91	0,66

Legenda: AS – aritmetička sredina; SD – standardna devijacija.

Na temelju tri varijable *korištenja televizije* izvršena je klasifikacija cijelog uzorka ispitanika u tri skupine (klastera, tipa) korisnika televizije kako bi se mogle utvrditi razlike u učestalosti (pripadnosti) pojedinom tipu korisnika televizije između djevojčica i dječaka. *Tip 1* korisnika je tip *nisko aktivnih* korisnika televizije, a televiziju koriste rijetko za sve potrebe. *Tip 2* korisnika je tip *srednje aktivnih* korisnika televizije, koji televiziju koriste najčešće za praćenje sporta, a potom nešto rjeđe za opće potrebe i praćenje zabavnih sadržaja. *Tip 3* korisnika je tip *visoko aktivnih* televizije, koji televiziju koriste najčešće za opće potrebe, potom za zabavne sadržaje, ali pritom i vrlo rijetko za praćenje sportskih sadržaja. Između ovih *tipova korisnika televizije* analizom varijance su utvrđene značajne razlike po njihovu stupnju korištenja televizije.

Tablica 4. Učestalost tipova korištenja televizije učenika i učenika

SKUPINA	DJEVOJČICE (N=289)		DJEČACI (N=312)		UKUPNO	χ^2 test
	UČESTALOST	%	UČESTALOST	%	UČESTALOST	
Nisko aktivni	58	20,07	97	31,09	155	$\chi^2 = 529,29$ df=2 p < 0,000
Srednje aktivni	92	31,84	188	60,26	280	
Visoko aktivni	139	48,10	27	8,65	166	

Utvrđeno je kako znatno veći postotak djevojčica pripada tipu *visoko aktivnih* korisnika televizije (49%), dok najviše dječaka pripada u tip *srednje aktivnih* korisnika televizije (60%). Donekle je slična učestalost *nisko aktivnih* korisnika televizije kod djevojčica i dječaka (20% i 31%).

Tablica 5. Diskriminativna analiza tipova korisnika televizije kod djevojčica i dječaka

UZORAK	λ	Rc	Wilks' lambda	χ^2	SS	p
DJEVOJČICE - DF1	0,11	0,32	0,87	41.15	12	0.000***
DJEVOJČICE - DF2	0,04	0,20	0,96	11.21	5	0.047*
DJEČACI	0,30	0,48	0,75	87.97	12	0.000***
VAR			Matrica strukture			
	DJEVOJČICE		DJEČACI			
OPĆA_SP_KOMP			0,86	0,18		-0,90
SPEC_SP_KOMP			0,74	0,60		-0,85
KINEZ_ANGAŽIR			0,61	0,43		-0,78
SAMOPOIMANJE			0,31	0,21		0,15
SLIKA_TIJELO			-0,06	0,41		-0,06
SLIKA_ZDRAVLJE			-0,18	0,12		0,39
VAR			Centroidi skupina			
	DJEVOJČICE		DJEČACI			
Nisko aktivni			-0,20	0,38		0,66
Srednje aktivni			0,49	-0,01		-0,44
Visoko aktivni			-0,24	-0,15		0,72

LEGENDA: λ – svojstvena vrijednost diskriminacijske funkcije; Rc – koeficijent kanoničke korelacije; Wilks' lambda – koeficijent Wilksova lambda ($W\lambda$) diskriminacijske funkcije; χ^2 – test značajnosti diskriminacijske funkcije – χ^2 test; ** - razina značajnosti DF od $p < 0.01$; SS – stupnjevi slobode; P= – razina statističke značajnosti DF (χ^2 -testa).

Prikazani su rezultati obje diskriminativne funkcije za subuzorak djevojčica te samo prva funkcija za subuzorak dječaka jer druga diskriminativna funkcija nije značajna. Rezultati diskriminativne analize u prostoru tipova korištenja televizije kod djevojčica pokazuju kako su utvrđene značajne razlike u prvoj diskriminativnoj funkciji između različitih tipova korisnika televizije ($p=0.000$). Skupina *srednje aktivnih* korisnika televizije se značajno razlikuje od skupina *nisko i visoko aktivnih* korisnika televizije. *Srednje aktivne* korisnice karakteriziraju visok stupanj visoka *specifična i opća percipirana sportska kompetencija* te *kineziološka angažiranost*, a uz nešto više izraženije *opće samopoimanje*. Druga diskriminativna funkcija također između različitih tipova korisnika televizije. Skupina *nisko aktivnih* korisnika televizije se značajno razlikuje od skupina *srednje i visoko aktivnih* korisnika televizije. *Nisko aktivne* korisnice karakteriziraju visok stupanj visoka *specifična percipirana sportska kompetencija* te nešto više *kineziološka angažiranost i slika o tijelu*.

Rezultati diskriminativne analize u prostoru tipova korištenja televizije kod dječaka pokazuju kako su utvrđene značajne razlike u prvoj diskriminativnoj funkciji između različitih tipova korisnika televizije ($p=0.000$). Skupina *srednje aktivnih* korisnika televizije se značajno razlikuje od skupina *visoko i nisko aktivnih* korisnika televizije. *Srednje aktivne* korisnike karakteriziraju visok stupanj zaokupljenosti sportom, *visoka opća i specifična percipirana sportska kompetencija* te *kineziološka angažiranost*. Druge dvije skupine korisnika karakterizira izražen nešto viši stupanj *percepcije osobnog zdravlja*.

RASPRAVA

Tri konstruirane ljestvice za mjerenje stupnja i učestalosti korištenja televizije kod adolescenata, koje imaju zadovoljavajuće mjerne značajke, a njima se može utvrditi korištenje televizije adolescenata za opće potrebe te za praćenje zabavnih i sportskih sadržaja. Adolescenti televiziju najviše koriste za praćenje općih sadržaja (informiranje, serije i filmovi) što je i očekivano s obzirom na osnovne značajke televizijskog medija, dok se zabavni (glazbene i show emisije) i sportski sadržaji nešto manje prate.

Za sve mjerene varijable psiholoških obilježja, kineziološke angažiranosti i korištenja televizije su utvrđene razlike po spolu ispitanika. Ovi nalazi su sukladni nalazima Milavića i sur. (2012) izuzev za mjeru *općeg samopoimanja* jer tada nije utvrđena razlika po kojoj učenice imaju višu razinu *općeg samopoimanja* od učenika. Za mjerene varijable korištenja televizije također su utvrđene razlike po spolu ispitanika pri čemu dječaci na televiziji značajno više prate sportske sadržaje, a djevojčice zabavne i druge sadržaje. Ove razlike proizlaze iz različitih interesa i stavova dječaka i djevojčica u adolescentskoj dobi za koje se može pretpostaviti kako se formiraju unutar vršnjačkih skupina, ali i obitelji adolescenata.

Tipizacijom korisnika televizije utvrđena su tri različita tipa, a interesantna je činjenica kako inače *visoko aktivni* tip korisnika TV vrlo rijetko prate sportske sadržaje od *srednje aktivnih* korisnika. Stoga ne «čudi» kako u tip *srednje aktivnih* korisnika češće pripadaju dječaci, nego li djevojčice. Preporuča se u daljnjim istraživanjima posebnu pozornost posvetiti razvrstavanju adolescenata u tipove korisnika TV i drugih tehnoloških naprava i to povećanjem broja tipova korisnika, kako bi se jasnije ocrtale navike i učestalosti korištenja pojedine sprave od strane adolescenata pojedinog spola. Preporuča se pokušati analizirati pripadnost pojedinim tipovima korisnika za svaki spol zasebno u

istom cilju. Ovoj preporuci u prilog ide i nalaz kako su dječaci u ovom istraživanju ili općenito «niski» korisnici TV ili pak učestalo prate sportske sadržaje. Naime, utvrđeno je samo oko 9% *visoko aktivnih* korisnika TV kod dječaka koji vrlo rijetko prate sport, a učestalo prate ostale sadržaje (opće i zabavne).

Razlika između skupina djevojčice, tipova korisnica TV (*srednje aktivne* korisnice) pokazuje kako među djevojčicama ima trećina (oko 32%) onih koje imaju visoku percipiranu sportsku kompetenciju, visoko su kineziološki aktivne te na TV učestalo prate sportske sadržaje. Za pretpostaviti je kako su to one osobe koje se još organizirano u klubovima bave sportskim ili plesnim aktivnostima, ali tu pretpostavku treba dodatnim istraživanjima i potvrditi. Vrlo sličan nalaz je utvrđen i za uzorak dječaka s tom razlikom kako je to kod dječaka najučestaliji tip korisnika TV (60% dječaka). Slično izražena psihološka obilježja i kineziološku aktivnost su Milavić i sur. (2012) utvrdili kod tipa *visoko aktivnih* korisnika računala, Milić i sur. (2014) utvrdili kod tipa *visoko aktivnih* korisnika mobitela i računala. Preporuča su u budućim istraživanjima «objediniti» analizu načina korištenja svih tehnoloških pomagala i organizirane kineziološke angažiranosti adolescenata i to na uzorcima s većom brojnošću ispitanika, kako bi se zasebno za svaki spol precizno utvrdila tipizacija, ali i specifična obilježja tipa korisnika tehnoloških sprava adolescenata.

ZAKLJUČAK

Konstruirane su tri ljestvice za mjerenje stupnja i učestalosti korištenja televizije kod adolescenata, koje imaju zadovoljavajuće mjerne značajke. Na cjelokupnom uzorku ispitanika, taksonomskom analizom, definirana su tri tipa korisnika televizije nazvana *nisko*, *srednje* i *visoko aktivni* korisnici televizije koji se značajno razlikuju po stupnju i učestalosti korištenja televizije. Učenice i učenici se međusobno razlikuju po učestalosti pripadnosti pojedinom tipu korisnika. Znatno veći postotak učenica pripada tipu *visoko aktivnih* korisnika televizije (48%), dok najveći postotak učenika pripada tipu *srednje aktivnih* korisnika televizije (60%), ali najčešće na TV prate sportske događaje. Tipovi korisnica televizije učenica i učenika se razlikuju značajno po izmjerenom kineziološkom aktivitetu i drugim psihološkim obilježjima. Kod učenica i učenika skupine najučestalijih skupina korisnika TV karakteriziraju visoko izražene *percipirana sportska kompetencija (opća i specifična)* i *kineziološka angažiranost*. Nalazi ovog istraživanja ukazuju na potrebu daljnjeg istraživanja učestalosti i načina korištenja televizije (i drugih dostupnih tehničkih sredstava poput mobitela ili računala) adolescenata u cilju preciznog utvrđivanja relacija

svih oblika sedentarnih aktivnosti s kineziološkim aktivitetom i psihičkim doživljavanjem adolescenata., ali i u cilju prevencije mogućeg negativnog utjecaja korištenja tehničkih sredstava na razvoj adolescenata.

LITERATURA

Andrijašević, M., Paušić, J., Bavčević, T., & Ciliga, D. (2005). Participation in leisure activities and self – perception of health in the students of the University of Split. *Kineziologija*, 3(1), 21-31.

Breslauer, N. (2008). *Tjelesna i zdravstvena kultura* (skripta). Čakovec: Međimursko veleučilište.

Kautiainen, S., Koivusilta, L., Lintonen, T., Virtanen, S.M., & Rimpela, A. (2005). Use of information and communication technology and prevalence of overweight and obesity among finnish adolescent. *International journal of obesity*, 29(8), 925-933.

Madden, M., Lenhart, A., Duggan, M., Cortesi, S., & Gasser, U. (2013). *Teens and Technology 2013 – report*. Pew Internet & American Life Project & The Berkman Center for Internet and Society at Harvard University. Stranici <http://www.pewinternet.org/Reports/2013/Teens-and-Tech.aspx> pristupljeno 21.04.2015.

Milavić, B., Guć, D., & Miletić, Đ. (2010). The Relations Between Types of Motivation in Sport and Perceived Sport Competence. *FACTA Univesitatis: Physical Education and Sport*, 8(1), 59-69.

Milavić, B., Milić, M., Grgantov, Z., Elezović, J., Đapić-Caput, P., & Sinovčić, P. (2012). Relacije između kineziološke angažiranosti, psiholoških obilježja i tipova korištenja računala. U Đ. Miletić, S. Krstulović, Z. Grgantov, T. Bavčević, & A. Kezić (Ur.), *Proceedings book of 4th International scientific conference „Contemporary kinesiology“*; (str. 696-704). Split: Kineziološki fakultet Sveučilišta u Splitu.

Milić, M., Milavić, B., & Grgantov, Z. (2014). Relations between kinesiological engagement, psychological characteristics and types of mobile phone and computer usage in adolescents. *Facta universitatis, Series: Physical Education and Sport*, 12(2), 191-201.

Samardžić, M., Bego, J., & Milavić, B. (2011). Psihološke razlike adolescenata ustrajnih u sportu i onih koji su odustali od organiziranog bavljenja sportom. In: Skender N., & Čikeš, N. (Eds.) *.Proceedings of 2nd International Symposium “ Sport, Tourism and Health”*. Bihać. Bosnia and Herzegovina.

Samdal, O., Tynjala, J., Roberts, C., Sallis, J.F., Villberg, J., & Wold, B. (2007). Trends in vigorous physical activity and TV watching of adolescents from 1986 to 2002 in seven European Countries. *European Journal of Public Health, 17*(3), 242-248.

Relacije sedentarnih ponašanja i kineziološkog aktiviteta adolescenata

Petra Sinovčić¹, Mirjana Milić², Sunčica Delaš Kalinski²

¹*Odjel za sociologiju, Sveučilište u Zadru, Hrvatska*

²*Kineziološki fakultet, Sveučilište u Splitu, Hrvatska*

ABSTRACT

The aim of this study was to determine the relations between different ways of using mobile phones and computers and kinesiological activity. Research was conducted on the sample of 601 older elementary school children from Split-Dalmatia County. Differences between genders were detected on the variable of kinesiological activity, as well as on the other variables that measured sedentary activities, and it was found that male students are more active than the female students. A taxonomical analysis was used to determine five types of technological devices users. Significant differences were found in the frequency of belonging to a certain type of user between male and female students. In the subsample of female students there are no differences between users considering the level of their kinesiological activity. In the subsample of male students there are significant differences between types of users and their level of kinesiological activity. *High active* users also have the highest level of kinesiological activity, and the *low active* users also have the lowest level of kinesiological activity. Significant effect of sedentary behavior variables on kinesiological activity was determinate on the both samples, and the variable that has contributed the most to the explanation of the criterion variable was the variable: following sports content on the TV.

Keywords: computer usage, kinesiological activity, mobile phone usage, students, TV usage

UVOD

Slobodno vrijeme se može definirati kao vrijeme aktivnog odmora, razonode, pozitivna razvoja, socijalizacije, humanizacije i stvaralačkog potvrđivanja ličnosti (Previšić, 2000, prema Badrić i Prskalo, 2011). Prema tome je i ono polje odgojnog djelovanja, a važni čimbenici socijalizacije, obitelj, škola, vršnjaci, mediji i društvo imaju neprijeporno djelovanje u prostoru slobodnog vremena mladih (Mlinarević i sur., 2007). Aktivnosti i prostor slobodnoga vremena mogu biti važno sredstvo za osnaživanje mladih kao i sfera za realizaciju njihovih interesa kao pojedinaca ili skupine (Jeđud i Novak, 2006). Slobodno vrijeme čovjeka je fenomen koji se u posljednje vrijeme sve više istražuje, a njegova kvaliteta i sadržaj su posebno važni za mlade i djecu jer pridonose formiranju njihova identiteta i kvalitete života. Djeca i mladi imaju znatno više slobodnog vremena od odraslih koje bi zbog njihovog biopsihosocijalnog statusa trebalo biti i specifično organizirano. Kao takvo, slobodno vrijeme mladih uvijek je bilo u središtu pozornosti kao društveni fenomen, sa svrhom pronalaska sadržaja koji bi ih motivirali da to vrijeme provedu baveći se različitim oblicima tjelesnih aktivnosti (Badrić i Prskalo, 2011). Tjelesno vježbanje definira se kao organizirana ili neorganizirana kineziološku aktivnost, a broj istraživanja o važnosti bavljenjem sportom i općenito kineziološkom angažiranošću mladih se kroz prethodne godine znatno povećao (Kautiainen i sur., 2005). Međutim, mladi danas, u slobodno vrijeme, sve više odabiru aktivnosti koje ne traže nikakav fizički napor te ga zahvaljujući novim tehnološkim dostignućima ispunjavaju korištenjem niza pasivnih sadržaja, poput televizije, računala i mobitela (Badrić i Prskalo, 2011). Na taj način suvremeno društvo nameće drugačiji životni ritam, kojem je potrebno prilagodite svoje vrijeme te postoji potrebna za aktivnim sudjelovanjem u tome (Mlinarević i sur., 2007). Može se pretpostaviti kako će suvremenu civilizaciju karakterizirati izrazito smanjenje fizičke aktivnosti i pasivni pojedinac (Mišigoj-Duraković, 2000, prema Mlinarević i sur., 2007). Takav način provođenja slobodnog vremena iz aktivnog postaje sedentaran, što je posebno problematično za djecu i mlade. Važnost kineziološkog aktiviteta je posljednjih godina prepoznata, uz brojana istraživanja koja su pokazala pozitivnu povezanost kineziološkog aktiviteta i fizičkog zdravlja, pokazao se i kako kineziološka angažiranost uz to može utjecati i na kognitivne funkcije te na konativne dimenzije odgovorne za modalitete ponašanja i efikasnu socijalizaciju mladih (Badrić i Prskalo, 2011). Problem je opadanja kineziološke angažiranost mladih s njihovim godinama, iako su mnogi

uzroci tome, najveći se nalaze u sve većoj informatizaciji i tehnizaciji društva (Kautiainen i sur., 2005). Televizija je kao mediji i kao oblik tehnizacije zasigurno najprisutnija i najdostupnija. Koristi se za praćenje svih vrsta sadržaja, od zabavnih do informativnih te je samim time sveprisutan način provođenja slobodnog vremena. U istraživanju provedenom na uzorku studenata o načinu provođenja slobodnog vremena pokazalo se kako studentice (69,1%) najviše vremena provode gledajući televiziju, dok je tjelesno aktivna bila svaka četvrta studentica (Andrijašević i sur., 2005). Uporaba osobnih računala je prvi primjer informatizacije društva. Adolescenti se računalima služe u različite svrhe poput razonode (igranje igrice, slušanje glazbe i gledanje filmova), ostvarivanja društvenih kontakata preko društvenih mreža, prikupljanje informacija i usvajanje novih znanja. Milavić i sur. (2012) su u istraživanju relacija kineziološke angažiranosti, psiholoških karakteristika i tipova korisnika računala opisali tri različita tipa korisnika računala kod adolescenata pri čemu se učenice i učenici razlikuju po učestalosti pripadnosti pojedinom tipu jer znatno viši postotak učenica pripada tipu *visoko aktivnih* korisnika računala. Kod učenika oni koje pripadaju tipu *visoko aktivnih* korisnika imaju značajno viši stupanj *pasivne* i *aktivne zaokupljenosti sportom*, *percipirane sportske kompetencije*, uz značajno niži stupanj percipirane *slike o svom zdravlju* od druga dva tipa. Sve je više pokazatelja kako je, uz navedene uređaje, korištenje mobitela povezano sa sedentarnim načinom života adolescenata. Milić i sur. (2014) su istraživali relacije korištenja mobitela i računala s kineziološkom aktivnošću i nekim psihološkim obilježjima adolescenata. Iako se učenici i učenice razlikuju po stupnju korištenja mobitela i računala u različite svrhe, ne razlikuju se po učestalosti pripadnosti pojedinom tipu korisnika mobitela. Oni koji pripadaju *nisko aktivnom* tipu korisnika mobitela i računala imaju značajno viši stupanj percipirane *slike o svom zdravlju* i *općeg samopoimanja* od drugih dvaju tipova. Za razliku od njih oni koji pripadaju tipu *visoko aktivnih* korisnika mobitela i računala imaju značajno viši stupanj *pasivne zaokupljenosti sportom*, a kod učenika imaju još nešto više izraženu *percipiranu sportsku kompetenciju* i *kineziološku angažiranost*. Opći cilj ovog istraživanja je utvrditi relacije sedentarnih ponašanja u obliku korištenja tehnoloških naprava i kineziološkog aktiviteta adolescenata kod učenika završnih razreda osnovne škole. Pri ostvarivanju tog cilja utvrdit će se učestalost i tipologija sedentarnih ponašanja adolescenata; rodne razlike u mjerenim varijablama i učestalosti pripadanja određenom tipu korisnika tehnoloških sprava; te mogući utjecaj sedentarnih ponašanja na kineziološki aktivitet adolescenata.

METODE

Uzorak ispitanika sastavljen je od 601 učenice i učenika 7. i 8. razreda osnovnih škola iz Splitsko-dalmatinske i Šibensko-kninske županije bez izraženog strukturalnog deformiteta koji bi limitirao njihovo bavljenje sportom, a od toga je bilo 289 učenica i 312 učenika. Skup mjerenih varijabli sačinjavale su varijable: ljestvica *kineziološkog aktiviteta (KINEZ_AKT)*, autora Milić i sur. (2011) te sedam varijabli različitih oblika sedentarnih ponašanja, ljestvice *korištenja računala za surfanje i komunikaciju (R_SRFKOM)*, *korištenja računala za zabavu i informiranje (R_ZABINF)* te *korištenja računala za nastavu (R_NASTAV)*, autora Milavić i sur., (2012); ljestvica *korištenja mobitela (MOBITEL)*, autora Milić i sur. (2014); ljestvice *korištenja ljestvica općeg korištenja televizije (TV_OPCE)*, *korištenja televizije za zabavu (TV_ZABAV)* te *korištenja televizije za praćenje sporta (TV_SPORT)* autora Pezelj i sur. (2015). Ovim se ljestvicama utvrđuje izraženost dijela sedentarnih ponašanja u različitim oblicima korištenja tehnoloških komunikacijsko-informacijskih naprava od strane adolescenata. Na temelju prosječnog rezultata svih sedam ljestvica sedentarnih ponašanja izračunata je i varijabla *ukupnog korištenja tehnoloških naprava*. Od statističkih postupaka korišteni su postupci za utvrđivanje osnovnih metrijskih značajki validiranih ljestvica, postupci za utvrđivanje razlika između skupina adolescenata po spolu i po načinu korištenja naprava (t-test) po izraženosti mjerenih varijabli, taksonomska analiza (klasteriranje po unaprijed određenom broju klastera, eng. *K-means clustering*) za određivanje tipova korisnika tehnoloških komunikacijsko-informacijskih naprava, te multipla regresija u cilju utvrđivanja utjecaja skupa varijabli sedentarnih ponašanja na varijablu kineziološke angažiranosti. Rezultati svih mjernih ljestvica su izračunati na način da se rezultati svih čestica pojedine ljestvica zbroje i potom podijele s ukupnim brojem čestica iste ljestvice. Time se ostvarila mogućnost uspoređivanja rezultata dobivenih na ljestvicama s različitim brojem čestica.

REZULTATI

Sve ljestvice su validirane na ovom uzorku ispitanika i imaju zadovoljavajuće mjerne karakteristike pouzdanosti, homogenosti i osjetljivosti za mjerenje, ali i za primjenu parametrijskih postupaka statističke obrade rezultata istraživanja.

Tablica 1. Deskriptivna statistika kineziološkog aktiviteta i sedentarnih ponašanja te utvrđivanje rodnih razlika

VARIJABLA	UKUPNO (N-601)		UČENICI (N-312)		UČENICE (N-289)		t-test	P=
	AS	SD	AS	SD	AS	SD		
KINEZ_AKT	3,08	1,13	3,28	1,06	2,88	1,18	4,39***	0,000
RC_SRFKOM	3,84	0,96	3,64	0,95	4,05	0,92	5,31***	0,000
RC_ZABINF	2,93	1,00	3,16	0,98	2,69	0,97	5,99***	0,000
RC_NASTAV	3,21	1,19	3,13	1,19	3,30	1,19	1,74	0,08
MOBITEL	3,30	1,05	3,05	1,05	3,57	0,98	6,24***	0,000
TV_OPCE	3,78	0,93	3,61	0,93	3,96	0,90	4,58***	0,000
TV_ZABAV	3,37	0,92	3,17	0,92	3,58	0,88	5,45***	0,000
TV_SPORT	3,16	1,26	3,62	1,12	2,67	1,22	9,89***	0,000
UKUPNO_TEHNO	3,37	0,64	3,34	0,68	3,40	0,59	1,15	0,25

Legenda: AS - aritmetička sredina, SD - standardna devijacija, t-test - koeficijent t-testa; P= - razina značajnosti koeficijenta t-testa, *** - razina značajnosti koeficijenta od $p < ,001$.

U tablici 1. su prikazani rezultati učenica i učenika na mjerenim ljestvicama te izračunate značajnosti razlika s obzirom na spol. Učenici imaju značajno viši *kineziološki aktivitet* od učenica. Učenici u prosjeku najviše vremena provode za računalom, tako što na njemu surfaju i komuniciraju te gledaju TV, a posebno gledaju sportske sadržaje na TV-u. Najmanje vremena provode u korištenju *mobitela* te korištenju računala za nastavne potrebe. Učenicice najviše slobodnog vremena provode za računalom, surfajući i komunicirajući te gledajući TV sadržaj općenito. Najmanje gledaju i prate sportske sadržaje na TV-u, kao i korištenje računala za potrebe zabave i informiranja. Zamjetno je kako između učenika i učenica postoje značajne razlike svih navedenih varijabli izuzev u varijabli *korištenje računala za nastavne potrebe*. Učenici više prate sport na TV-u i više koriste računalo za zabavu i informiranje od učenica. Učenicice više koriste računalo za surfanje i komunikaciju, više koriste mobitel te više koriste TV u općenite i zabavne svrhe. Nisu utvrđene značajne razlike u stupnju *ukupnog korištenja tehnoloških sprava*. Na temelju provedene klaster analize je izvršena tipizacija, raspoređivanje svih ispitanika u pet tipova korisnika tehnoloških naprava. Tipizacija je napravljena na način da se ispitanici rasporede u tipove (klustere) korisnika s ciljem postignuća maksimalno mogućih razlika u mjerenim varijablama između pojedinih klastera, tipova korisnika. Provedena je na čitavom uzorku ispitanika kako bi se mogla uspoređivati učestalost pripadanja

učenika i učenica pojedinom tipu korisnika. Tipovi korisnika se međusobno značajno razlikuju po načinu i stupnju korištenja ovih tehnoloških naprava. U tablici 2. prikazane su prosječne mjere korištenja računala, mobitela i TV-a za pet različitih tipova korisnika.

Tablica 2. Prosječne vrijednosti oblika sedentarnih ponašanja različitih tipova korisnika

TIP KORISNIKA	Tip 1	Tip 2	Tip 3	Tip 4	Tip 5
RC_SRFCOM	2,61	3,29	4,35	4,50	4,44
RC_ZABINF	1,93	2,72	3,39	2,90	3,70
RC_NASTAV	2,23	3,57	2,14	3,06	4,40
MOBITEL	2,32	2,76	3,45	3,83	4,08
TV_OPCE	2,92	3,40	4,03	4,20	4,30
TV_ZABAV	2,29	3,15	3,32	3,73	4,12
TV_SPORT	2,15	3,68	4,22	1,75	4,05

Tip 1 predstavlja skupinu *nisko aktivnih* korisnika računala, mobitela i TV-a. U ovoj skupini ispitanika, gdje su raspoređeni i učenici i učenice, zamjetno je kako su prosječne vrijednosti rezultata korištenja tehnoloških naprava znatno niže u odnosu na rezultate ostalih skupina. Ovi ispitanici vrlo malo vremena provode koristeći mobitel, računalo ili TV. Tipovi 2 i 3 korisnika predstavljaju skupine *srednje aktivnih* korisnika računala, mobitela i TV-a. Ovi ispitanici imaju viši stupanj korištenja naprava za razliku od ispitanika iz prve skupine. Međusobno se razlikuju po tome što tip 3 korisnika ima nešto više rezultate u svim mjerenim varijablama izuzev u varijabli korištenja računala u nastavne svrhe. Tipovi 4 i 5 korisnika predstavljaju skupine *visoko aktivnih* korisnika računala, mobitela i TV-a. Ovi ispitanici imaju najviše stupnjeve korištenja tehnoloških naprava u odnosu na sve ostale skupine ispitanika, tipove korisnika. Međusobno se razlikuju po tome što tip 4 korisnika ima zamjetno niži rezultat u mjeri korištenja TV-a za praćenje sportskih sadržaja. U tablici 3. prikazane su pripadnosti učenika i učenica pojedinom tipu korisnika tehnoloških naprava (računala, mobitela i TV-a), a utvrđena je i razlika u učestalosti pripadanja različitim tipovima korisnika između učenika i učenica.

Tablica 3. Učestalosti i razlike učenica i učenika po tipu korištenja tehnoloških naprava

TIP KORISNIKA	UČENICE (N-289)		UČENICI (N-312)		UKUPNO	χ^2 test
	FREKVENCIJA	%	FREKVENCIJA	%	FREKVENCIJA	
1	46	15,92	51	16,35	97	$\chi^2 = 179,24$ SS=4 P<0,000
2	48	16,61	111	35,58	159	
3	26	9,00	61	19,55	87	
4	112	38,75	20	6,41	132	
5	57	19,72	69	22,12	126	

LEGENDA: χ^2 - koeficijent hi-kvadrat testa, SS - stupnjevi slobode, P - razina značajnosti koeficijenata,

Zamjetno je kako najveći postotak učenica (38.75%) pripada tipu 4 (*visoko aktivne korisnice*, ali bez praćenja sporta), dok kod učenika najviši postotak (35.58%) pripada tipu 2 (*srednje aktivni korisnici*). Tipu 4 (*visoko aktivni korisnici*) pripada tek 6.41% učenika, dok tipu 2 pripada samo 9.00% učenica. Sličan postotak korisnika i za učenike i za učenice se utvrđuje u tipovima korisnika 1 i 5, skupinama koje najmanje i najviše koriste tehnološke naprave. Izračunati koeficijent hi-kvadrat testa potvrđuje značajnu razliku ($p < 0.000$) u pripadnosti pojedinom tipu korisnika naprava između učenica i učenika. Kako su prethodno utvrđene razlike u stupnju korištenja tehnoloških naprava i kineziološkog aktiviteta, te razlike u učestalosti pripadanja pojedinim tipovima korisnika tehnoloških naprava između učenika i učenica, zasebno su za svaki od ta dva poduzorka ANOVA-om utvrđene razlike u izraženosti stupnja kineziološkog aktiviteta između pojedinih skupina, tipova korisnika tehnoloških naprava.

Tablica 4. Testiranje razlika između pojedinih tipova korisnica tehnoloških sprava po stupnju kineziološkog aktiviteta

KINEZIOLOŠKI AKTIVITET	AS±SD TIP 1	UČENICE *					
		TIP 2	TIP 3	TIP 4	TIP 5		
UČENICE *	TIP 1	2,75±1,12		0,73	0,82	0,99	0,53
	TIP 2	3,09±1,07	0,73		1,00	0,26	1,00
	TIP 3	3,10±1,21	0,82	1,00		0,49	1,00
	TIP 4	2,63±1,21	0,99	0,26	0,49		0,10
	TIP 5	3,16±1,14	0,53	1,00	1,00	0,10	

LEGENDA: * - prikazane su razine statističke značajnosti razlika izračunate Scheffe testom; AS±SD - aritmetička sredina i standardna devijacija skupine ispitanika.

Iako je utvrđena ukupna značajna razlika ($F=2.89$, $p=0.02$) između tipova korisnika po stupnju kineziološke angažiranosti, naknadno provedena *post-hoc* analiza primjenom Scheffeovog testa pokazuje kako se tipovi korisnika tehnoloških naprava zapravo ne razlikuju po stupnju svoje kineziološke angažiranosti.

Tablica 5. Testiranje razlika između pojedinih tipova korisnika tehnoloških sprava po stupnju kineziološkog aktiviteta

KINEZIOLOŠKI AKTIVITET		AS±SD		UČENICI *				
		TIP 1	TIP 2	TIP 3	TIP 4	TIP 5		
UČENICI *	TIP 1	2,49±1,02			0,00	0,00	0,97	0,00
	TIP 2	3,30±0,85	0,00			1,00	0,12	0,00
	TIP 3	3,35±1,19	0,00	1,00			0,10	0,01
	TIP 4	2,67±1,12	0,97	0,12	0,10			0,00
	TIP 5	3,94±0,74	0,00	0,00	0,01	0,00		

LEGENDA: * – prikazane su razine statističke značajnosti razlika izračunate Scheffe testom; AS±SD – aritmetička sredina i standardna devijacija skupine ispitanika.

Za poduzorak učenika, utvrđena je ukupna značajna razlika ($F=19.34$, $p=0.000$) između tipova korisnika tehnoloških naprava po stupnju njihove kineziološke angažiranosti. Naknadno provedena *post-hoc* analiza primjenom Scheffeovog testa pokazuje kako se od tipova korisnika tehnoloških naprava razlikuju od samo dva tipa korisnika, *visoko aktivni* korisnici tipa 5 i *nisko aktivni* korisnici tipa 1. Između poduzorka učenica i učenica koji pripadaju istom tipu korisnika tehnoloških naprava postoje zamjetne razlike u izraženosti kineziološke angažiranosti, ali one nisu detaljno utvrđivane s obzirom na prethodno utvrđenu opću značajnu razliku kineziološke angažiranosti između ova dva poduzorka. U cilju detaljnog utvrđivanja relacija i mogućeg utjecaja sedentarnih ponašanja, korištenja tehnoloških sprava i kineziološkog aktiviteta adolescenata za svaki poduzorak je proveden postupak multiple regresije s varijablom kineziološkog aktiviteta kao kriterijskom varijablom, a skupom varijabli korištenja naprava kao prediktorskim skupom varijabli.

Tablica 6. Utjecaj varijabli sedentarnog ponašanja na kineziološku angažiranost adolescenata

SEDENTARNA PONAŠANJA	KINEZIOLOŠKA ANGAŽIRANOST			
	UČENICE		UČENICI	
	BETA	P	BETA	P
RC_SRFCOM	0,01	0,91	-0,00	0,98
RC_ZABINF	-0,09	0,17	0,04	0,57
RC_NASTAV	0,05	0,41	0,20***	0,000
MOBITEL	0,00	0,95	0,23***	0,001
TV__OPCE	-0,08	0,24	-0,02	0,76
TV_ZABAV	-0,02	0,82	-0,08	0,22
TV_SPORT	0,30***	0,000	0,36***	0,000
R	0,33***		0,53***	
R ²	0,11		0,28	
F (7,281); (7,304)	4,80		17,17	
P	0,000		0,000	

LEGENDA: BETA - regresijski koeficijent, R - koeficijent multiple korelacije, R² - koeficijent determinacije, F - koeficijent značajnosti, P - razina značajnosti koeficijenata.

Za oba poduzorka, utvrđen je značajan utjecaj varijabli sedentarnih ponašanja, varijabli korištenja tehnoloških naprava na varijablu njihove kineziološke angažiranosti. Utjecaj je za poduzorak učenica nešto manje izražen (11% objašnjene varijance) nego za uzorak učenika (28% objašnjene varijance). Praćenje sportskih sadržaja na TV je jedini značajan prediktor ($p=0.000$) u oba poduzorka ispitanika, a kod učenika su još utvrđeni značajni prediktori i *korištenje mobitela* ($p=0.000$) te *korištenje računala u nastavne svrhe* ($p=0.001$).

RASPRAVA I ZAKLJUČAK

Nalazi ovog istraživanja potvrđuju prethodna istraživanja o višem kineziološkom aktivitetu učenika u odnosu na učenica (Milić i sur., 2011; Milavić i sur., 2012). U ovom je istraživanju utvrđeno kako je ukupna prosječna mjera svih mjerenih sedentarnih oblika vrlo slična za učenike i učenice, ali i da oni to „prosječno“ vrijeme koriste na različite načine. Potvrđeni su i nalazi u učestalijem i više korištenju mobitela učenika u odnosu na učenike, te nalaz o višem stupnju korištenja računala za zabavu i informiranje učenika u odnosu na učenice (Milić i sur., 2014.). U ovom istraživanju je utvrđen i različit

nalaz u vezi korištenja računala za socijalnu komunikaciju i opće surfanje pri čemu učenice učestalije i dugotrajnije u tu svrhu koriste računala u odnosu na učenike. Također, nije u potpunosti potvrđen nalaz iz istog istraživanja Milić i sur. (2014) o višem stupnja korištenja računala za nastavne potrebe kod učenica, iako je u ovom istraživanju utvrđena zamjetna razlika u „korist“ učenica, ali ona nije dosegla razinu statističke značajnosti. Razlike koje su utvrđene moguće je pripisati brojnosti i specifičnostima ispitanika iz uzoraka ispitanika ovih istraživanja. U ovom istraživanju u odnosu na istraživanje Milić i sur. (2014) je uzorak ispitanika gotovo dvostruko brojniji, sa šireg je zemljopisnog područja i izmjeren je u školama iz različitih veličina naselja. Njihov je uzorak ispitanika iz škola u tri manja grada (Kaštela, Solin i Trogir) koji su zemljopisno vrlo blizu smješteni. Pet utvrđenih tipova korisnika tehnoloških naprava se značajno razlikuju jedni od drugih po načinima i učestalosti korištenja naprava. Milić i sur. (2014) su napravili tipizaciju korisnika računala i mobitela, a Pezelj i sur. (2015) tipizaciju korisnika televizije, na tri tipa korisnika. Stipić (2014) je napravio tipizaciju korisnika računala, mobitela i televizije na četiri tipa korisnika te je utvrdio jasne razlike između pojedinih tipova korisnika tehnoloških naprava. Uspoređujući rezultate tipizacija s različitim brojem tipova korisnika zamjetno je kako već i podjela na tri tipa korisnika daje korisne informacije o načinima korištenja tehnoloških naprava, ali podjela na tri tipa je više prilagođena za tipizaciju ispitanika na osnovu manjeg broja varijabli. Za tipizaciju ispitanika na osnovu većeg broja varijabli, kao u ovom istraživanju, kvalitetnije informacije o aktivnostima korisnika se utvrđuju na osnovi većeg broja klastera, četiri ili više klastera. Preporuča se u budućim istraživanjima „prilagoditi“ broj tipova (klastera) korisnika broju varijabli i broju ispitanika u uzorku za tipizaciju, ali i korisnosti dobivenih informacija u razlikovanju utvrđenih tipova ispitanika s kriterijem jasnoće u razlikovanju utvrđenih tipova korisnika po stupnju izraženosti onih varijabli na osnovu kojih je i izvršena tipizacija. Nalazi o razlikovanju u učestalosti pripadanja pojedinom tipu korisnika tehnoloških naprava između učenica i učenika potvrđuju prethodne nalaze Pezelja i sur. (2015), a razlikuju se od nalaza Milić i sur. (2014). Drugi autori (Stipić, 2014; Milavić i sur., 2012) su utvrđivali učestalost pripadnosti klasteru, ali ne i rodne razlike tih učestalosti. Preporuča se u budućim istraživanjima preciznije utvrditi razlike u učestalosti pripadnosti ispitanika pojedinim tipovima korisnika. Rezultati

ovog istraživanja koji pokazuju kako se tipovi korisnika tehnoloških naprava u poduzorku učenica međusobno ne razlikuju po svojem kineziološkom aktivitetu, dok se u poduzorku učenika razlikuju te prethodno utvrđene rodne razlike u mjerenim varijablama i u učestalosti pripadanja pojedinim tipovima korisnika, navode na preporuku kako bi cjelokupna istraživanja ovakvoga tipa trebalo ponoviti zasebno na uzorcima ženskih i muških ispitanika. Na poduzorku učenika utvrđena je „povezanost“ korištenja tehnoloških naprava najvišeg stupnja s najvišim stupnjem kineziološkog aktiviteta, te korištenja tehnoloških naprava najnižeg stupnja s najnižim stupnjem kineziološkog aktiviteta učenika. Ostali se tipovi korisnika naprava međusobno ne razlikuju po svojem kineziološkom aktivitetu. Između ove dvije pojavnosti postoji suplementaran odnos, te je visoki kineziološki aktivitet popraćen visokim stupnjem sedentarnih ponašanja i to učestalim i dugotrajnim korištenjem tehnoloških naprava. Rezultati provedenih multiplih regresija pokazuju kako je praćenje sportskih sadržaja na TV-u značajno „utječe“ na kineziološki aktivitet adolescenata oba spola. Takav je nalaz razumljiv te očekivan jer interes za sportske i općenito kineziološke aktivnosti iskazuje u sljedećim pojavnostima, kako osobnog vježbanja adolescenta, tako i njihova povišenog stupnja interesa za praćenje sličnih sadržaja na TV-u. Nalaz za učenike kako pored varijable praćenje sporta na TV, na kineziološki aktivitet utječu i varijable *korištenja mobitela* i *korištenja računala za nastavne sadržaje* nije jednostavno interpretirati. Moguće je kako učenici i mobilni telefone često koriste za praćenje i razmjenu sportskih sadržaja. Zaključno, cjelokupni nalazi ovog rada upućuju na potrebu provođenja daljnjih istraživanja, te se na njihovim temeljima mogu stvoriti određene preporuke za ista, ali tek nakon što se ispravno prepoznaju i navedu ograničenja istog istraživanja. Ljestvicama korištenim u ovom radu nije moguće utvrditi apsolutnu dnevnu ili tjednu količinu vremena u kojoj adolescenti koriste tehnološke naprave, nego samo relativne odnose između pojedinaca ili skupina adolescenata. Stoga se preporuča u budućim istraživanjima utvrditi i sljedeće, moguće važne faktore za kineziološki aktivitet ili za učestalost sedentarnih ponašanja adolescenata: utvrditi osobno i obiteljsko posjedovanje te općenito dostupnost određenih tehnoloških naprava adolescentima; povećati ukupan broj ispitanika i proširiti uzorak na više županija; provoditi tipizaciju korisnika tehnoloških naprava zasebno za učenike, zasebno za učenice; provjeriti učinkovitost u pribavljanju korisnih informacija i drugih mogućih oblika tipizacije ispitanika; istražiti demografska i socijalna obilježja svakog tipa korisnika tehnoloških naprava.

LITERATURA

Andrijašević, M., Paušić, J., Bavčević, T., & Ciliga, D. (2005). Participation in leisure activities and self – perception of health in the students of the University of Split. *Kineziologija*, 37(1), 21-31.

Badrić, M., & Prskalo, I. (2011). Participiranje tjelesne aktivnosti u slobodnom vremenu djece i mladih. *Napredak*, 152(3-4), 479-494.

Jeđud, I. & Novak, T. (2006). Provođenje slobodnog vremena djece i mladih s poremećajima u ponašanju – kvalitativna metoda. *Revija za sociologiju* 37(1-2), 77-90.

Kautiainen, S., Koivusilta L., Lintonen T, Virtanen S. M., & Rimpela, A. (2005). Use of information and communication technology and prevalence of overweight and obesity among finnish adolescent. *International journal of obesity*, 29(8) 925-933.

Milavić, B., Milić, M., Grgantov, Z., Elezović, J., Đapić-Caput, P., & Sinovčić, P. (2012). Relacije između kineziološke angažiranosti, psiholoških obilježja i tipova korištenja računala. In Đ. Miletić, S. Krstulović, Z. Grgantov, T. Bavčević, & A. Kezić (Eds.), *Proceedings book of 4th International Scientific Conference „Contemporary Kinesiology“* (pp. 696-704). Split: Faculty of Kinesiology, University of Split.

Milić, M., Milavić, B., & Grgantov, Z. (2011). Relacije između zaokupljenosti sportom, samopoimanja, motivacije za sport i tipova korištenja računala adolescenata. In: Simović S. (Ed.) *Book of Summaries of 3rd International Scientific Conference „Anthropological Aspects of Sport, Physical Education and Recreation“* (pp. 43). Banja Luka: Faculty of Physical Education and Sport, University of Banja Luka.

Milić, M., Milavić, B., & Grgantov, Z. (2014). Relations between kinesiological engagement, psychological characteristics and types of mobile phone and computer usage in adolescents. *Facta universitatis, Series: Physical Education and Sport*, 12(2), 191-201.

Mlinarević, V., Miliša, Z., & Proroković, A. (2007). Slobodno vrijeme mladih u procesima modernizacije - usporedba slavonskih gradova i Zadra. *Pedagogijska istraživanja*, 4(1), 81-99.

Stipić, G. (2014). *Relacije između sedentarnih ponašanja i odustajanja od organizirane kineziološke angažiranosti adolescenata* (Diplomski rad). Kineziološki fakultet Sveučilišta u Splitu.

Pezelj, L., Milavić, B., Gamulin, T., Sinovčić, P., & Šesnić, Z. (2015). Relacije između kineziološke angažiranosti, psiholoških obilježja i tipova korištenja televizije adolescenata. *Proceedings book of 5th International Scientific Conference „Contemporary Kinesiology“* (accepted, in press). Split: Faculty of Kinesiology, University of Split.

Sastav tijela kod različito kineziološki angažiranih studentica

Melis Mladineo Brničević¹, Daša Duplančić², Josefina Jukić³, Siniša Zagorac⁴

¹University of Split, Faculty of Law, Split, Croatia

²University of Split, Faculty of Economy, Split, Croatia

³University of Split, Faculty of Kinesiology, Split, Croatia

⁴University college of management and design, ASPIRA, Split, Croatia

ABSTRACT

Analysis of body composition and degree of kinesiology engagement was conducted on a sample of 184 female students newly enrolled in the first year. The level of kinesiology commitment to the college admission was determined by questionnaire. Method bioelectrical impedance (BIA) measured the proportion of fat and muscle mass in the total mass of the body. Univariate analysis of variance were obtained results indicate significant differences among college segregated groups of inactive, active in sport and active in recreation. The greatest differences were obtained between the students who worked and those who have been inactive during secondary education. The results suggest the need for greater motivation of students and the facilities in which to continue stimulate student interest in kinesiology major engagement.

Key words: bioelectrical impedance, body mass index, fat percentage, muscle mass.

UVOD

Prekomjerna tjelesna težina i pretilost te nedovoljna tjelesna aktivnost povezani su s brojnim kroničnim bolestima. Upravo održanje optimalne tjelesne težine i povećanje razine tjelesne aktivnosti vrlo su važni ciljevi javnozdravstvene politike većine razvijenih zemalja svijeta. Prevalencija

pretilosti u svijetu, u razdoblju od 1980. do 2014., se više nego udvostručila, (WHO, 2013). Problem pretilosti u stalnom je porastu i u Hrvatskoj u mlađoj odrasloj i odrasloj populaciji kao i kod djece i adolescenata, pogotovo kod ženskog spola (Kolčić i sur., 2010, Milanović i sur., 2012) što zahtjeva dodatne intervencije u prevenciji. Prema rezultatima HZA (Hrvatska zdravstvena anketa) iz 2003. prevalencija povećane tjelesne mase u odraslih osoba RH (ITM 25-29,9) iznosi 38,1 %. Povećanu tjelesnu masu ima manje od 10% najmlađih žena, ali se taj udio značajno povećava nakon 25. godine života. Prevalencija pretilosti (ITM ≥ 30) iznosi 20,4% s otprilike podjednako zastupljenim spolovima (20,1% muškaraca i 20,6% žena). U Hrvatskoj se udio pretilih povećava s dobi. Više od 40% odraslih ima visceralni tip debljine (opseg struka ≥ 102 cm kod muškaraca odnosno ≥ 88 cm kod žena, kriteriji SZO-a). Istraživanje stanja uhranjenosti djece u dobi od 6,5 do 18,5 godina ukazalo je na postojanje sekularnog trenda, prema kojem su djeca iste dobi viša i teža u odnosu na svoje vršnjake u razdoblju od 1980. do 1984. godine (dječaci u dobi od 7 godina za 2,7 cm viši; djevojčice za 2,5 cm). U pogledu tjelesne mase, najveće razlike su nađene kod 16-godišnjih dječaka koji su teži u prosjeku 8,7 kg te kod djevojčica u dobi od 11 do 12 godina koje su teže u prosjeku 5,2 kg. Osim sekularnog trenda, zabilježen je i zabrinjavajući nesrazmjer u povećanju tjelesne mase u odnosu na tjelesnu visinu, sa sve većim udjelom djece s povećanom tjelesnom masom odnosno pretilošću. U razdoblju od 2005. do 2009. godine 26,4% djece imalo je prekomjernu tjelesnu masu, od čega je 15,2% bilo preuhranjeno, a 11,2% pretilo. Značajan porast prevalencije prekomjerne tjelesne mase među djecom i odraslim stanovništvom svrstava Hrvatsku među vodeće zemlje po prevalenciji prekomjerne tjelesne mase u Europi, ali i u svijetu. Suвременa definicija pretilosti podrazumijeva uvećanje ukupne masne, a ne ukupne tjelesne mase, i to u mjeri koja dovodi do narušavanja zdravlja i razvoja niza komplikacija, a nastaje kao posljedica disbalansa između energetske unosa i energetske potrošnje (WHO 2000., Lev-Ran, 2001). U većini slučajeva uvećanje tjelesne mase zaista nastaje na račun masne mase tijela, međutim primjenom suvremenih postupaka za određivanje tjelesnog sastava uočena su određena odstupanja (Stokić, 2004). Tako, uvećanje tjelesne mase ne mora nastati na račun masne, već mišićne mase tijela (npr. kod atletičara), te se oni ne mogu klasificirati kao pretili. Suprotno tome, i osobe sa normalnom tjelesnom masom, tj. normalno uhranjene osobe, mogu imati veću masnu masu od

referentne. Ovakav oblik pretilosti naziva se gojaznost u normalnoj tjelesnoj masi ili sarkopenična gojaznost, s obzirom na to da je masna masa uvećana na račun redukcije mišićne mase (Marques-Vidal, 2010). I ovaj oblik pretilosti također je udružen sa nizom čimbenika rizika za razvoj komplikacija, samo blažeg stupnja. Sarkopenična gojaznost je česta kod žena i djece. Prema podacima 10% mladih žena ima ovaj oblik gojaznosti (Gallagher i sur.,2000). Sa stanovišta razvoja mogućih kardiometaboličkih komplikacija pretilosti, pored masne mase, značajna je i distribucija masnog tkiva. Usporedno s globalnim porastom prevalencije pretilosti događalo se i smanjenje stupnja tjelesne aktivnosti. Tjelesna je aktivnost jedan od temeljnih načina poboljšanja fizičkog i duševnog zdravlja ljudi, smanjuje rizike nastanka mnogih kroničnih nezaraznih bolesti i ublažuje njihovo napredovanje. Kod djece je zabilježen negativni sekularni trend za količinu tjelesne aktivnosti vezane uz prijevoz, školu i organizirane sportske aktivnosti, ali ne i u količini tjelesne aktivnosti u slobodno vrijeme (Dollman i sur. 2005.). dok se kod odrasle populacije ovaj negativan trend veže uz prijevoz i posao ali ne i u segmentu slobodnog vremena (Barengo i sur. 2002). Nadalje, izrazito smanjenje razine tjelesne aktivnosti uočeno je kod adolescenata (Telama i sur. 1997, Koppes i sur. 2004). Rezultati HZA iz 2003. pokazuju da se ukupno 30,5% hrvatskih građana starijih od 18 godina smatra fizički neaktivnim, s podjednakom prevalencijom u muškaraca (28,9%) i žena (31,9%). Prevalencija fizičke neaktivnosti 2008. je bila veća nego 2003. Prema rezultatima istraživanja o zdravstvenom ponašanju djece školske dobi za 2010. godinu, mladi u Hrvatskoj umjereno su tjelesno aktivni – u prosjeku samo 4,2 dana u tjednu (4,6 dana dječaci i 3,8 dana djevojčice). Posebno je zabrinjavajuća činjenica da je najniža razina tjelesne aktivnosti utvrđena u dobnoj skupini 15-24 godine (Jurakić i sur.,2009) stoga se smatra kako je ovo životno razdoblje tj. prelazak iz adolescencije u odraslu dob vrlo bitno za istraživanje promjena pokazatelja statusa uhranjenosti i razine kineziološke angažiranosti. Većina metoda za procjenu građe tijela koristi dvokomponentni model masnog i nemasnog tkiva, s naglaskom na količinu i postotak tjelesnih masti. Indeks tjelesne mase (BMI) koji se definira kao težina tijela u kilogramima podijeljena sa visinom izraženom u metrima na kvadrat ($BMI = \text{kg}/\text{m}^2$). I visoki i vrlo niski BMI povezani su s većom smrtnošću. Cilj ovog rada bio je utvrditi da li se studentice koje su tijekom srednješkolskog obrazovanja bile aktivne razlikuju u body mass indexu, postotku masti i udjelu mišićne mase od studentica koje su se bile rekreativno ili slabo i nikako kineziološki angažirane.

METODE RADA

Uzorak ispitanika

Istraživanje je provedeno na uzorku od 184 studentice prve godine Splitskih fakulteta. Uzorak ispitanika činile su tri grupe ispitanica koje su podijeljene s obzirom na njihovu kineziološku angažiranost tijekom srednjoškolskog obrazovanja. Prva grupa ispitanica je ona s najviše kineziološkog angažmana (5 i više puta tjedno-AKTIVNE), druga s umjerenim kineziološkim angažmanom (3-4 puta tjedno-REKREATIVNE) a treća s nikakvim ili vrlo malim kineziološkim angažmanom (0-2 puta tjedno-NEAKTIVNE). Starosna dob studentica bila je od 18-19 godina.

Uzorak varijabli

Kineziološka angažiranost procijenjena je upitnikom na skali s 3 razine ekstenziteta kineziološke angažiranosti, u vidu rekreativnih (aktivnost u ekstenzitetu 3-4 sata tjedno), institucionalnih sportskih aktivnosti (5 i više sati tjedno) te nikakva ili aktivnosti vrlo malog inteziteta (aktivnost u ekstenzitetu 0-2 sata tjedno). Na uzorku je uz pomoć Omron vage izmjerena tjelesna visina, težina tijela, body mass index (BMI), postotak potkožnog masnog tkiva, mišićna masa i bazalni metabolizam. Sva mjerena su rađena po standardnom postupku.

Metoda obrade podataka

Za obradu podataka koristila se Software STATISTICA12. Za metodu obrade podataka koristila se deskriptivna statistika i univarijantna analiza varijance.

REZULTATI I DISKUSIJA

Rezultati deskriptivnih parametara antropometrijskih mjera studentica. Izračunate su aritmetička sredina, standardna devijacija, min i max rezultat, skewnis i kurtosis. Sve varijable su normalno distribuirane. Usporedbom dobivenih rezultata vidljivo je da prva grupa ispitanica (tablica 1.) ima manje vrijednosti bmi, postotka masti, tjelesne težine te višu vrijednost mišićne mase.

Tablica 1. Osnovni deskriptivni parametri (1.grupa)

Varijabla	N	AS	Minimum	Maximum	SD	Skew	Kurt
Tjelesna visina	51	170,725	156,000	180,000	6,122	-0,169	-0,630
Tjelesna težina	51	59,567	43,600	76,400	7,098	0,227	0,323
BMI	51	20,408	16,600	24,300	1,912	0,018	-0,576
Tjelesna mast	51	27,816	13,300	39,600	5,513	-0,410	0,227
Mišićna masa	51	29,510	23,800	38,700	2,908	0,746	0,957
bazalni metabolizam	51	1341,549	1168,000	1547,000	88,579	0,301	-0,077

AS (aritmetička sredina), minimum (najmanji rezultat), maximum (najbolji rezultat), SD (standardna devijacija), Skewness (mjera asimetrije), Kurtosis (mjera izduženosti)

Tablica 2. Osnovni deskriptivni parametri (2.grupa)

Varijabla	N	AS	Minimum	Maximum	SD	Skew	Kurt
Tjelesna visina	73	169,432	150,000	184,000	6,355	-0,253	0,424
Tjelesna težina	73	62,455	38,400	104,300	10,504	1,026	2,749
BMI	73	21,701	17,100	35,300	3,170	1,836	5,137
Tjelesna mast	73	29,538	9,200	51,700	7,401	0,208	0,654
Mišićna masa	73	28,356	14,000	37,500	4,421	-1,060	2,218
bazalni metabolizam	73	1381,616	1070,000	1774,000	128,871	0,516	0,440

AS (aritmetička sredina), minimum (najmanji rezultat), maximum (najbolji rezultat), SD (standardna devijacija), Skewness (mjera asimetrije), Kurtosis (mjera izduženosti)

Druga grupa ispitanica (tablica 2.) u odnosu na prvu ima nešto veći BMI i postotak masti, a manji udio mišićne mase, dok u usporedbi s trećom grupom ima manji BMI i postotak masti, a veći udio mišićne mase.

Tablica 3. Osnovni deskriptivni parametri (3.grupa)

Varijabla	N	AS	Minimum	Maximum	SD	Skew	Kurt
Tjelesna visina	60	170,592	155,000	183,000	5,668	-0,340	0,107
Tjelesna težina	60	65,807	52,800	98,300	9,617	1,319	2,383
BMI	60	22,577	18,700	34,000	2,669	1,588	4,603
Tjelesna mast	60	27,997	18,000	34,500	3,023	-0,474	0,963
Mišićna masa	60	32,743	20,300	48,100	5,732	0,171	0,079
bazalni metabolizam	60	1400,517	1226,000	1747,000	114,066	0,927	1,260

AS (aritmetička sredina), minimum (najmanji rezultat), maximum (najbolji rezultat), SD (standardna devijacija), Skewness (mjera asimetrije), Kurtosis (mjera izduženosti)

Treća grupa ispitanica (tablica 3) ima najviše vrijednosti BMI, postotka masti, a najmanje mišićne mase u odnosu na ostale grupe. Iako sve grupe imaju po mjernim skalama normalne vrijednosti i BMI-a i postotka masti ipak je uočljivo da studentice s više kineziološkog angažmana imaju po sastavu manje masti a više mišićne mase. Ako dobivene rezultate usporedimo s rezultatima nekih drugih istraživanja također provedenih na uzorku studentica Splitskog sveučilišta (Rogulj i sur, 2011), vidljivo je da je BMI studentica ovog istraživanja nešto niži.

Tablica 4. Razlika između 1. i 2. grupe ispitanica

Varijabla	AS (1.grupa)	AS (2.grupa)	F ^A	p ^A
Tjelesna visina	170,725	169,432	1,2826	0,2596
Tjelesna težina	59,567	62,455	2,9207	0,0900
BMI	20,408	21,701	6,7607	0,0105
Tjelesna mast	27,816	29,538	1,9895	0,1609
Mišićna masa	29,510	28,356	2,6638	0,1052
bazalni metabolizam	1341,549	1381,616	3,7029	0,0566

AS (aritmetička sredina), F^A - F-test za ANOVA, p^A - razina značajnosti

Analizom varijance između prve i druge grupe, utvrđeno je da postoje statistički značajne razlike u BMI-u (tablica 4.).

Tablica 5. Razlika između 2. i 3. grupe ispitanica

Varijabla	AS (2.grupa)	AS (3.grupa)	F ^A	p ^A
Tjelesna visina	169,432	170,592	1,2089	0,2736
Tjelesna težina	62,455	65,807	3,6164	0,0594
BMI	21,701	22,577	2,8892	0,0916
Tjelesna mast	29,538	27,997	7,5329	0,0069
Mišićna masa	28,356	32,743	0,2864	0,5934
bazalni metabolizam	1381,616	1400,517	0,7849	0,3773

AS (aritmetička sredina), F^A - F-test za ANOVA, p^A - razina značajnosti

Druga i treća grupa se značajno razlikuju u postotku masnog tkiva (tablica 5.), dok se prva i treća grupa značajno razlikuju u gotovo svim varijablama naročito u BMI-u, postotku masti i udjelu mišićne mase (tablica 6.).

Tablica 6. Razlika između 1. i 3. grupe ispitanica

Varijabla	AS (1.grupa)	AS (3.grupa)	F ^A	p ^A
Tjelesna visina	170,725	170,592	0,0143	0,9051
Tjelesna težina	59,567	65,807	14,6698	0,0002
BMI	20,408	22,577	23,4343	0,0000
Tjelesna mast	27,816	27,997	21,0989	0,0000
Mišićna masa	29,510	32,743	7,1498	0,0087
bazalni metabolizam	1341,549	1400,517	9,0076	0,0033

AS (aritmetička sredina), F^A - F-test za ANOVA, p^A - razina značajnosti

Analiza varijance jasno razlikuje grupu aktivnih (grupa 1.) od neaktivnih studentica (grupa 3.), što ide u prilog dosadašnjim istraživanjima da se povećanim kineziološkim angažmanom reducira masno tkivo, a dobiva na mišićnoj masi. Studentice iz ovog istraživanja mjerene su na početku prve godine studiranja, gdje se još uvijek osjeća utjecaj kineziološkog angažmana tijekom srednje škole, za razliku od istraživanja koja prate studente kasnije tijekom prve i viših godina fakulteta (Rogulj i sur, 2011), gdje se većina studentica prestaje baviti kineziološkom aktivnošću, te je podatak da ih aktivno ostaje svega 8,5 %, a u rekreaciji 5,3% zabrinjavajuć. Od sveukupne studentske populacije 70% studentica se uopće ne bavi nikakvom sportskom aktivnošću. Vjerojatno je ipak osnovni razlog nedostatne kineziološke angažiranosti općenito niska kineziološka kultura i nerazvijena svijest o važnosti kinezioloških aktivnosti za zdravlje i kvalitetu života čovjeka, a naročito nerazvijena navika tjelesnog vježbanja.

ZAKLJUČAK

Na ukupnom uzorku studentica koje su podijeljene u tri grupe s obzirom na kineziološku angažiranost tijekom srednjoškolskog obrazovanja, dobili smo očekivane razlike između grupa, posebno onih studentica koje su bile aktivne u usporedbi s studenticama koje su bile neaktivne ili s mali kineziološkog angažmana. Analiza varijance statistički značajno razlikuje te dvije grupe ispitanica u BMI-u postotku masti te udjelu mišićne mase. Ovakvi rezultati idu u prilog dosadašnjim istraživanjima, te ukazuju na potrebu za kineziološkom aktivnošću. Poznato je da kineziološke aktivnosti aktiviraju sve sustave organizma, posebno mišićni, krvožilni i dišni. Pojačanom funkcijom u uvjetima mišićnog rada pospješuju se brojni fiziološki procesi ,

čime se smanjuje i rizik od pojedinih bolesti. Kineziološke aktivnosti moraju se provoditi redovito i uz opterećenja primjerena uzrastu, zdravstvenom stanju i razini fizičkog potencijala organizma. Najveće promjene prisutne su u morfološkim značajkama, osobito na mišićnom tkivivu. Pozitivna kineziološka transformacija antropološkog statusa bi trebala biti jedna od primarnih zadataka nastave tjelesne i zdravstvene kulture u institucijama odgoja i obrazovanja.

LITERATURA

Barengo, NC., Nissinen, A., Tuomilehto, J., & Pekkarinen, H. (2002). Twenty-five-year trends in physical activity of 30- to 59-year-old populations in eastern Finland. *Med Sci Sports Exerc* ; 34(8):1302–1307.

Dollman, J., Norton, K., & Norton, L. (2005). Evidence for secular trends in children's physical activity behaviour. *Br J Sports Med.*; 39(12):892-7. 95.

Gallagher, D., Heymsfield, S., Hero, M., Jebb, S., Murgatroyd, R., & Sakamoto, Y. (2000). Healthy percentage body fat ranges: an approach for developing based on body mass index. *Am J Clin Nutr*; 72(3):694-701.

Jurakić, D., Pedišić, Ž., & Andrijašević, M. (2009). Physical activity of Croatian population: Cross-sectional study using International Physical Activity Questionnaire. *Croatian Medical Journal.*;50:163-168.

Kolcic, I., Polasek, O., & Vuletic, S. (2010). "Scale and dynamics of overweight and obesity epidemic in croatia." *Obes Facts* 3(5): 333.

Koppes, LLJ., Twisk, JWR., & Kemper, HCG. (2004). Longitudinal trends, stability and error of biological and lifestyle characteristics. U: Kemper HCG (ur): Amsterdam Growth and Health Longitudinal Study. *Med Sport Sci.* Basel, Karger; 44-63.

Lev-Ran, A. (2001) Human obesity: an evolutionary approach to understanding our bulging waist line. *Diabetes Metab Res Rev*; 17:347-62.

Marques-Vidal, P., Pécoud, A., Hayoz, D., Paccaud, F., Mooser, V., & Waeber, G. (2010). Normal weight obesity: relationship with lipids, glycaemic status, liver enzymes and inflammation. *Nutr Metab Cardiovasc Dis*;20(9):669-75.

Milanovic, S. M., Uhernik, A.I., Fister, K., Mihel, S., Kovac, A., & Ivankovic, D. (2012). "Five-year cumulative incidence of obesity in adults in Croatia: the CroHort study." *Coll Antropol* 36 Suppl 1: 71-76.

Rogulj, N., Kovačević, Ž., Utrobičić, I., Krstulović, H., & Jukić, J.(2011). Indeks tjelesne mase različito kineziološko angažiranih studentica i studenata Život i škola, br. 25., str. 100. – 107.

Stokić, E. (2004). Gojaznost je bolest koja se leči. Novi Sad: Medicinski fakultet; str. 11-72.

Telama, R., Yang, X., Laakso, L., & Viikari, J. (1997). Physical activity in childhood and adolescence as predictor of physical activity in young adulthood. *Am J Prev Med*; 13(4):317–323.

WHO. (2013). Global Health Observatory Data Repository [online database]. Geneva, World Health Organization, (<http://apps.who.int/gho/data/view.main>, accessed 21 May 2013).

World Health Organization. (2000). Obesity: preventing and manigingthe global epidemic. Report of WHO consultation. WHO Tech Rep Ser;894:1-253.

Going retro with the Indians: or do the native american sports mascots endanger the american society?

Hugo Guelet, Mario Pujol, Ana Penjak

Faculty of Kinesiology, University of Split, Croatia

ABSTRACT

Many sports clubs in America that wear Native American nicknames, logos or mascots have been asked to change it. Various researchers have addressed the issue of the Native American mascots, primarily in sports, from various angles in order to find out what stands behind this quest. In their studies, researchers have been assigning the problem different attributes and meanings. While one see it as a positive factor in the society that stands as a symbol of honor, pride, respect and tolerance, the others perceive it as a mockery, shame and social threat. The article conflicts the two opposing sides. By doing so, the article aims at giving an insight into a larger representational system hidden behind the issue of mascots. It wants to highlight the role of 'Indianness' as a prominent voice in the construction of the U.S. identity, and their role in history that is perceived as white America's shameful part. In conclusion, mascots must be understood as a symbol of respect, dignity and national pride, and not something that people should be ashamed of.

Key words: sport symbols, tradition, racism, American football

INTRODUCTION

Sports and the moral values it convey represent a kind of social laboratory in which individuals' behaviours are mirrored as a micro-society itself (Elias, 1969). Sports help us understand the society, social relationships, as well as ourselves (Elias, 1969). Through years, Western societies have tried to look at any type of difference (racial, social, political, religious, sexual, etc.) equally

and, as such, to offer them equal possibilities and standards (Carrington, 2013; Jacobs & Taylor, 2012). It is believed that sports, as a mirror of any society, offer the best example of the aforementioned equality. Indeed, today's concept of sports is far from what it was a long time ago – a place where warriors confronted each other, a place of extreme violence and cruelty. The essence of modern sport tries to highlight not just the essence of equality, but also the sense of belonging to some group of people who share the same interests and passions; a sense of sharing the same identity. Apart from this, today, we perceive sports through another viewpoint – media and culture. Media (visual and written forms) and cultural contexts, today, have a huge impact (positive or negative) on people who watch, participate or just follow sports. They produce and embody cultural identities; transmit and define culturally acceptable behaviors; they form cultural patterns for various types of identities, etc. (Kosanović, 2008). In one word, media and culture, today, create new reality in which people receive its information and accept it through stereotypes which happens with the mascots in the American sports (Lindsay, 2015). Slogans, logos, colours, symbols, mascots, nickname all create the identity of sports teams to which people relate (Nelson, 2013). For example, the FC Barcelona under their slogan “Més que un club” (More than a club) transmits, share and show the values and social recognition of the club. Thanks to its accessibility, media and cultural contexts create and shape opinions of many people and athletes. In doing so, they create a paradox in which, on the one side, they help create, shape and foster positive stereotypes in a society, while, on the other side, they encourage negative stereotypes and hate speech that both get recognized and transmitted to the world of sport worldwide (Mezey, 2007).

On the other side, politics and sports have always been interweaving (politics organize social life, deal with the diversity of communities, make decisions, vote laws, etc.). Socio-cultural and economical interests ensue from the field of sport when it comes to political governance. It is through semiotic embodiment of various sports symbols that social and political authorities claim their significance and force over the people in the society (Newman, 2007; Strong, 2004). The Olympic Games, for example, through the values attributing to sport and competition has become absorbed by the politics and the marketing. The best example of this is its mascot that changes with every new Olympics and to which, by buying one; people get connected and identified with. Mascots, in general in sports, always attract people's attentions; it represents a symbol of a club to which people identify themselves. The Native

Americans mascots are the example this article wants to pay attention to. So many controversies have emerged on the issue of the Native American mascots. The first aim of this study is to present how culturally, socially and politically created stereotypes influence sports. The article takes into consideration aspects and viewpoints on the issue of the Native American mascots as an example where the aforementioned context keeps on interfering into the essence of the American sports clubs, as well as its fans. Example of the Native American mascots will be presented and approached in the relationship to various negative and abusive social debates that reveal marginalization, stereotypization and stigmatization of Native Americans as a minority group, on the one side, and through the positive examples of how this issue can be approved and approached differently so as not to see it as a threat, on the other side. The conclusion provides a concise and comprehensive personal opinion of the debate, as well as the general conclusion on the topic

WHAT'S ROTTEN IN THE NATIVE AMERICAN MASCOTS? OR, DO SPORTS MASCOTS REALLY PRESENT SOCIAL THREAT?

'Most people here would not make mocking references to black Americans (publicly, at least). Why do people who would never dream of making unflattering stereotypical references to black Americans seem to feel American Indians are somehow fair game?' (C.R. King, 2013) Since the 90s, the controversies around the Native Americans seen through sports mascots have been multiplying and spreading globally. In 2005, the issue began to take central stage in the fight for Indigenous rights and respect for cultural and historical identity on the American Indians (Hoffman, 2012). In August that year, the National Collegiate Athletic Association (NCAA) banned 18 schools ineligible to host post-season NCAA championships starting in 2006 because of the hostile and abusive usage of American Indian nicknames or mascots (Hoffman, 2012; Staurowsky, 2007; Taylor, 2013). From that moment onwards, controversies around the topic have been flowering. They differ in the attitude and opinion they transmit; thus, from positive to extremely negative ones. But the thing they have in common is the real issue hidden behind the Native American sports mascots: ethnic and racial issue, oppression issues of the marginalized (in this context indigenous people), ignorance, disgrace, mockery, etc. In the last decades of the 20th century, many sports clubs wearing the Native American mascots, like the Cleveland Indians ('Chief Wahoo' logo), the Washington NFL team (the 'Redskins' logo), have been asked to change their club names, to retire, as well

as their mascots with the explanation that these mascots do not show positive, strong and respectful image (Cain, 2001; Rosenstein, 2001). Some of them, like Oklahoma's University, did indeed change their nickname. But why is that so; and what is the real issue hidden behind it?

Many negative references have been surrounding American sports, in general. Some are very present, like using forbidden substances (C. R. King, 2008), while there are issues that are much harder to reveal and are a part of various discriminations in a society. One of these issues is the way some people perceive the meaning of various Native American mascots that stand as the symbol of many sports clubs (Davis-Delano & Crosset, 2008; Hill, 2014; Jacobs, 2014; Morris, 2015). According to M. L. Brune, mascots, today, are not exclusively used from team sports, but also as various company logos (Brune, 2010).

Because of the limited space, the article gives brief overview of those in favour and against the usage of the Native American mascots in sports examples, as well as in the American society, in general.

Those whose set of argument are in favour of the Native American mascots say the mascots transmit positive semiotic image such as, honour, pride, respect, determination, and excellency (Brune, 2010). In his study, Brune states that 543 interviewed people support the use of the Native American Mascot as something of positive value, while 153 of them oppose the idea of mascots as a symbol of pride, thus, stating that it does is contributes to the marketing and school spirit (Brune, 2010). The Native American imagery, in many schools, represents a hostile environment. Some researchers report on the investigation that the U.S. Department of Education did in schools on the topic whether the use of the Native American mascots violates the civil rights of Native American students by creating a hostile environment. The results showed that we can talk on the issue of the hostile environment in the primary schools, but not in the high schools and universities (Baca, 2004; Trainor, 1995). In his article, Strong underlines and reports on the shameful treatment of the mascots as well as the derogatory nickname, 'savage slot', for the Native Americans in the society, which he himself definitely judges. He argues on how the 'mascot slot' assigned to the Native Americans represents an obstacle for the cultural recognition and full participatory citizenship (Strong, 2004). There are surprising examples that show how people who are not 'ethnically Indian' claim their 'Indianness' so as to be able to participate and argue in favor of Native American mascots (Springwood, 2004).

Reports on the negative usage and different semiotic reference of the Native American mascots are as many as the opposing ones. Some of the examples of the negative connotations that get related to the mascots primarily relate to the racial issue (Steinfeldt & Wong, 2010). Others, like the one Farnell writes on, state on how the American Indians mascots, through the local dancing practices at the University of Illinois, known as Chief Illiniwek dance, also extracts explicit negative racializing representations, stigmatizing, and stereotyping (Farnell, 2004). King in his article reports precisely on the negative stereotypes around the mascots in the sporting worlds (C. R. King, 2004). It is also believed that negative imagery and its outcomes cannot be explained by any social approaches (Davis-Delano & Crosset, 2008). Davis-Delano and Crosset believe that culture and social structures create groups of people who shape social movement outcomes (Davis-Delano & Crosset, 2008). Morris tracks the trouble with the mascots in their false propagate through which wrong and misleading beliefs about others contribute to disrespectful misrelationships in the society (Morris, 2015). As such, according to Morris, they should be socially judged, changed and resisted (Morris, 2015). Taylor also believes that the mascots only serve as the manipulating power of the white male. Through the public display (primarily media) mascots serve as a means of dishonoring minority groups, of reinforcing stereotypes grounded in historical pattern based again on power and hierarchy by white males (Taylor, 2015).

Spindel, in her book *Dancing at Halftime: Sports and the Controversy over American Indian Mascots*, in the concluding chapter, summarizes and highlights the problem by saying that we should not think of the Native Americans as minority groups situated in a context in comparison to white people superiority, but rather as groups of people with equal right no matter their number (Spindel, 2002).

CONCLUSION

In order to understand the Native American mascots issue, one must oversee the core of the problem. Every society presents a network of various relationships that may have the positive or negative influence on its members. Because of its 'melting pot' diversity, opinions get formed into stereotypes (positive or negative) and images that foster these relationships creating and defining, at the same time, their individual and collective identities. Once adopted, these stereotypes and images become highly resistant to change.

Forming patterns of accepted behaviors, stereotypes represent common way of thinking and communication with its socio-cultural context. The Native American mascots show the example of this 'injustice'. Publicly they get, gets displayed in two ways: positive and negative. When viewed as positive, mascots simply signify honor, pride and dignity of people. To perceive Indians as a national disgrace is hypocritical. One should remember the episode from the American history where the Americans treated Indians unfairly, as well as their treatment of black Americans. So, it is obvious why the Native American mascots evoke negative associations.

The authors of the article believe that the issue discussed on the Native American mascots is much more serious. It, actually, extends to other issues such as, how modern, developed, democratic society such as the American one, treats poorly all the differences in their society. The negative approaches to the topic reveal the ignorance and denial towards Indians as a part of the American history, as well as their presence in the modern American society. Mascots symbolize Native American's culture, their values and believes; their dignity and solidarity. They cannot be banned, retired, erased or misused, but learned to tolerate and understood as a part of the national, collective identity.

REFERENCES

- Baca, L. R. (2004). Native images in schools and the racially hostile environment. *Journal of Sport & Social Issues*, 28(1), 71-78. doi: 10.1177/0193732503261149
- Brune, M. L. (2010). *A Qualitative Study of a Native American Mascot at "Public University"*. (Ph.D. Dissertation), University of Missouri, Saint Louis. Retrieved from http://gateway.proquest.com/openurl?url_ver=Z39.88-2004&rft_val_fmt=info:ofi/fmt:kev:mtx:dissertation&res_dat=xri:pqdiss&rft_dat=xri:pqdiss:3417623
- Cain, T. R. . (2001). The Native American Mascot Debate. *About Campus* 31-32.
- Carrington, B. (2013). The Critical Sociology of Race and Sport: The First Fifty Years. *Annual Review of Sociology*, Vol 39, 39, 379-398. doi: 10.1146/annurev-soc-071811-145528
- Davis-Delano, L. R., & Crosset, T. (2008). Using social movement theory to study outcomes in sport-related social movements. *International Review for the Sociology of Sport*, 43(2), 115-134. doi: 10.1177/1012690208095375

Elias, N. (1969). Über den Prozess der Zivilisation: Wandlungen des Verhaltens in den weltlichen Oberschichten des Abendlandes: Francke.

Farnell, B. (2004). The fancy dance of racializing discourse. *Journal of Sport & Social Issues*, 28(1), 30-55. doi: 10.1177/01937325032503261887

Hill, C. G. (2014). Contesting Constructed Indian-ness: The Intersection of the Frontier, Masculinity, and Whiteness in Native American Mascot Representations. *Journal of Anthropological Research*, 70(2), 317-318.

Hoffman, E.D.L. (2012). *American Indians and Popular Culture*: ABC-CLIO.

Jacobs, M. R. (2014). Race, Place, and Biography at Play: Contextualizing American Indian Viewpoints on Indian Mascots. *Journal of Sport & Social Issues*, 38(4), 322-345. doi: 10.1177/0193723514530568

Jacobs, M. R., & Taylor, T. (2012). Challenges of Multiracial Antiracist Activism: Racial Consciousness and Chief Wahoo. *Critical Sociology*, 38(5), 687-706.

King, C. R. (2004). This is not an Indian - Situating claims about Indianness in sporting worlds. *Journal of Sport & Social Issues*, 28(1), 3-10. doi: 10.1177/0193732503261147

King, C. R. (2008). Teaching Intolerance: Anti-Indian Imagery. *Review of Education, Pedagogy, and Cultural Studies*, 30(5), 420-436.

King, C.R. (2013). *Unsettling America: The Uses of Indianness in the 21st Century*: Rowman & Littlefield Publishers.

Kosanović, S. (2008). Suvremene muško-ženske konstrukcije u američkim televizijskim serijama Seks i grad, Kućanice i Vatrene dečki. *Medijska istraživanja*, 14(2), 87-102.

Lindsay, P. (2015). The Trouble With Stereotypes: A Reply To Morris. *Journal of the Philosophy of Sport*, 42(2), 299-305. doi: 10.1080/00948705.2015.1036879

Mezey, N. (2007). The paradoxes of cultural property. *Columbia Law Review*, 107(8), 2004-2046.

Morris, S. P. (2015). The Trouble with Mascots. *Journal of the Philosophy of Sport*, 42(2), 287-297. doi: 10.1080/00948705.2014.997740

Nelson, M.R. (2013). *American Sports: A History of Icons, Idols, and Ideas*: ABC-CLIO.

Newman, J. I. (2007). Army of Whiteness? Colonel Reb and Sporting Souths Cultural and Corporate Symbolic. *Journal of Sport and Social Issues*, 31(4), 315-339.

Rosenstein, J. (2001). In Whose Honor?: Mascots and the Media. In R. C. King & C. Fruehling (Eds.), *Team Spirits: The Native American Mascots Controversy* (pp. 241-256). Springwood. Lincoln: University of Nebraska Press.

Spindel, C. (2002). *Dancing at Halftime: Sports and the Controversy Over American Indian Mascots*: NYU Press.

Springwood, C. F. (2004). "I'm Indian too!" - Claiming native American identity, crafting authority in mascot debates. *Journal of Sport & Social Issues*, 28(1), 56-70. doi: 10.1177/0193732503261477

Staurowsky, E. J. (2007). "You know, we are all Indian" Exploring White power and privilege in reactions to the NCAA Native American Mascot Policy. *Journal of Sport & Social Issues*, 31(1), 61-76. doi: 10.1177/0193723506296825

Steinfeldt, J. A., & Wong, Y. J. (2010). Multicultural Training on American Indian Issues: Testing the Effectiveness of an Intervention to Change Attitudes Toward Native-Themed Mascots. *Cultural Diversity & Ethnic Minority Psychology*, 16(2), 110-115. doi: 10.1037/a0018633

Strong, P. T. (2004). The mascot slot - Cultural citizenship, political correctness, and pseudo-Indian sports symbols. *Journal of Sport & Social Issues*, 28(1), 79-87. doi: 10.1177/0193732503261672

Taylor, M. (2013). *Contesting Constructed Indian-ness: The Intersection of the Frontier, Masculinity, and Whiteness in Native American Mascot Representations*: Lexington Books.

Taylor, M. (2015). Indian-Styled Mascots, Masculinity, and the Manipulated Indian Body: Chief Illiniwek and the Embodiment of Tradition. *Ethnohistory*, 62(1), 119-143. doi: 10.1215/00141801-2681750

Trainor, D. J. (1995). Native American mascots, schools, and the title VI hostile environment analysis. *University of Illinois Law Review*(4), 971-1001.

Factors associated with physical activity in a sample of Macedonian students of Ss. Cyril and Methodius University

Vujica Zivkovic, Seryozha Gontarev, Kalac Ruzdija

Faculty of Physical Education, Sport and Health, Ss. Cyril and Methodius University, Skopje, Macedonia

ABSTRACT

Background: The basic goal of this research is to determine how demographic, psychological, social and environmental factors influence the physical activity among the student population. The research was realized on a sample of 257 respondents drawn by random choice from several faculties within the University of "St. Cyril and Methodius" in Skopje. The sample is divided into two subsamples according to the gender and that is 124 male respondents and 133 female respondents. The average age of the respondents of both genders was 18.9 years. **Methods:** Students completed a questionnaire which examined their level of participation in Physical activity and sedentary behaviours along with a number of potential correlates. Hierarchical regression was used to explore the relationship between hypothesised factors and Physical activity. **Results:** on the basis of the obtained result can be concluded that boys unlike girls show significant higher level of physical activity. The respondents of both gender who live in rural environment have lower level of perceived barriers. They perceive higher social support from friends and parents, they have access to sports objects and have higher level of physical activity. Sports tradition in family also have great influence on physical activity for respondents of both gender. In both gender it is not determined the significant connection between sedentary habits (watching TV, computer use, studying) and physical activity. **Conclusions:** the research results point to the importance of preparation on national plan and program to promote the

unhealthy life habits and to increase the physical activity, and thus to improve their health.

Keywords: physical activity, Sedentary activity, perception, barriers, benefits, social support

INTRODUCTION

The World Health organization in all their acts cite about the physical activity significance for keeping the health, especially in prevention and treating the chronic disease (WHO, 2004; McKenzie, 2001). Many scientific-expert studies point out the causative-consecutive relation of the physical activity, physical fitness and the health of the individual. (Mišigoj-Duraković, 2008; Džepina M, Čavlek T., 2004). In the mentioned studies is emphasized the causatives such as: lack of physical activity, sedentary life style, inadequate nutrition, overweight, smoking, alcohol and drug consumption and the food disorder that is more widespread that is manifested as anorexia and bulimia. In recent researches is marked the problem of insufficient physical activity and the propensity towards different behaviours, especially among student population (Džepina M, Čavlek T., 2004; Mandac V et al., 2001; Kuzman M et al, 2004; Huddleston S et al., 2002). Students are part of the young population who prepare themselves for important role in the social life, who as academically educated people with their knowledge and experience will influence on the future children and young people generations. The sudden decline of physical activity is especially expressed during adolescence (15-19 years) by which the students are in risky group (Wallace LS et al., 2000). The problem of insufficient physical activity among students is recognized in many European countries, in Great Britain popularly is called "coach potato society", and in our country it is known under the name of "homo-sedentary population" or "population of young elders".

The results of recent researches indicates that determined demographic variables, increasing the level of perceived benefits towards physical activity, decreasing the perceived barriers, increasing the social support from the most intimate ones in the environment (parents and peers), the access to the sport equipments and objects are factors that are related to physical activity in adolescence and early mature age (Pate, et al., 1999; Sallis, et. al., 1992; Sallis et al., 2000; Cavill and Biddle 2003).

In the Republic of Macedonia there is small number of studies which has researched the factors that have influence on physical activity among young people and adolescents (Gontarev 2007; Kalac et al., 2014), and generally there is no studies in which is covered the student population, who have their own speciality.

Because of all the above, this research is realized in order to : (a) determine how demographic, psuchological, social and enviromental factors have influence on the physical activity among student population, (b) determine if the indicators of the ophysical activity differ by gender and (c) give reccomendations for interventions with the aim of promoting this group of population.

METHOD OF WORK

Participants – Subjects

The research is realized on a smaple of 257 respondents drawn by random choice of different faculties within the University of “St, Cyril and Methodius” in Skopje. The sample is divided into two subsamples according to the gender and thus 124 male respondents and 133 female respondents. The average age of the respondents from both gender is 18.9. The respondents were treated in accordance with the Helsinki Declaration.

Measures

A questionnaire was used to identify (i) demographic factors (ii) hephysical activity, (iii) the sedentary behaviour and (iv) the factors associated with physical activity.

Demographic factors: An seven-item investigator-developed questionnaire was used to collect demographic data. The following demographic data and participant characteristics were collected to describe the study sample: sex, Education of the father, Education of the mother, Monthly income, Whether the father is dealing with sport, Whether the mother is dealing with sport, living place.

Physical Activity: Moderate-to-vigorous physical activity (MVPA) was measured using an item modified from the Health-Behaviour in School-aged Children (HBSC) study, which was found to have acceptable reliability and validity (Booth, Okely, Chey, & Bauman, 2001). The respondents were asked

to answer how many times per week are physically active, that lasts for 20 minutes or longer. The students got the following definition for MVPA; '*activity that makes you breathe heavily and increases your heart rate.*'

Sedentary behaviours: the sedentary habits are estimated by the scale which is part of the HBSC study (Currie, C., et al. 2000). The respondents were asked to answer how much time they spend in sedentary habits such as: watching TV (including DVD), computer use (playing computer games, chatting, surfing on the internet). The questions are firstly referred to the working days (Monday-Friday) and then on the non-working days. The respondents answered on each particle, that is fixed on 3 level scale, ranging 1 hour, 2-3 hours, 4 or more hours. The respondents' answers are categorized into three groups.

Perceived Benefits. Perceived benefits are estimated by using a 9-item scale, stating the reasons why some people are physically active. For example, physical activity... "is fun", "helps me keep in shape" or "make me stronger". The same is Likert type 5 degrees, ranked from 1 (completely disagree) to 5 (completely agree). The result is calculated as the average of the answers of all particles (Inchley, J., et al., 2008).

Perceived Barriers. Perceived barriers are estimated by using a 9-item scale, stating the reasons why some people are not physically active. For example, 'I don't have enough time', 'I am not interested in physical activity' or 'I don't have the right equipment'. The same is Likert type 5 degrees, ranked from 1 (never) to 5 (very often). The result is calculated as the average of the answers of all particles (Inchley, J., et al., 2008).

Parental Support. Levels of paternal and maternal support for being active were measured using an adapted version of a scale from the Amherst Health and Activity Study (Sallis, J.F., et al., 2002; Prochaska, J.J., et al., 2002). Five items assessed different aspects of parental support including encouragement, participation in joint activities, provision of transport, observation and praise. Responses ranged from 'a lot' to 'not at all'. A mean score, ranging from 1-5, was computed by averaging responses to the five items.

Peer Support. Peer support for being active was measured using an abridged version of the parental support scales. Two items assessed how often friends provided encouragement to be active and how often they took part in joint activities. Responses ranged from 'a lot' to 'not at all'. A mean score, ranging from 1-5, was computed by averaging responses to the five items.

8. Physical Activity Enjoyment. The question of "How much do you enjoy doing physical activity?" was asked, as well as asking respondents about their enjoyment of physical education at school and how many of their friends are physically active (Inchley, J., et al., 2008).

Neighbourhood safety: Two items, adapted from the Amherst Health and Activity Study Student Survey (Inchley, J., et al., 2008), were used to measure perceived neighbourhood safety in relation to physical activity (walking or cycling): It is safe to walk or cycle alone during the day in the area where I live. It is difficult to walk or cycle in the area where I live because of things like traffic, no pavements, dogs, gangs etc. (Responses: agree a lot / agree a bit / neither agree nor disagree / disagree a bit / disagree a lot). A mean neighbourhood safety score (range 1-5) was computed based on responses to the two items. Item 2 was reverse-coded.

Availability of local facilities: Pupils were asked which of the following facilities they have in the area where they live: sports centre, playing field, park, swimming pool, basketball courts or hoops, tennis courts (responses: yes / no / don't know). A total availability score (range 0-6) was computed based on the number of 'yes' responses (Inchley, J., et al., 2008).

Access to local facilities: Pupils were asked how easy it is for them to get to the following facilities: sports centre, playing field, park, swimming pool, basketball courts or hoops, tennis courts (responses: very easy / quite easy / not very easy / not at all easy / don't know). A total access score (range 0-6) was computed based on the number of 'very easy' or 'quite easy' responses (Inchley, J., et al., 2008).

Statistical Analysis

The data was processed using the statistical package SPSS for Windows Version 20.0. The distribution normality of the variables is tested with Kolmogorov-Smirnov method, and log transformations were made when possible. The variables that met the criteria of normality were analyzed by using parametric statistical procedures, while the variables that did not meet the criteria of normality was analyzed by using non-parametric statistical procedures. Mann-Whitney U tests were used to compare differences in PA for gender. Comparison of means used a two-tailed hypothesis with the alpha levels set at $p < .05$. Spearman's *Rho* correlation was used to analyse the relationship between PA and potential correlates. Factors associated with PA were entered into hierarchical regression models.

RESULTS

In order to determine whether there are differences in physical activity, sedentary habits, psychosocial factors, the safety of the neighborhood, number, proximity and access to sports objects among male and female respondents, is applied the Mann-Whitney U test. From the review of Table 1 in which are shown the results of the applied analysis can be seen that between both students of male and female gender statistically significant differences were established in the variables: Physical activity ($p=,004$), Perceived benefits of physical activity ($p=,000$), Parents support ($p=,000$), Peer support ($p=,000$), Neighbourhood safety ($p=,000$), number of objects in the environment($p=,002$), Availability of local facilities ($p=,000$), watching TV (Weekdays) ($p=,043$), watching TV (Weekends) ($p=,000$), Computer use (Weekdays) ($p=,002$), Computer use (Weekends) ($p=,001$) and Homework ($p=,000$).

Table 1. Means and standard deviations for study variables grouped by gender and Mann-Whitney U tests

	Males		Females		sig
	Mean	SD	Mean	SD	
Benefits	4,02	0,77	3,48	0,83	,000
Barriers	2,63	0,53	2,54	0,68	,731
Parental support	3,07	0,97	2,60	0,92	,000
Frineds support	3,71	1,15	3,15	1,00	,000
Environment safety	2,77	0,93	2,14	1,02	,000
Environment objects	2,28	1,50	1,72	1,23	,002
Assessible objects	3,20	1,12	2,54	1,30	,000
Tv-weekdays	1,78	0,70	1,95	0,66	,043
Tv_weekedns	2,03	0,83	2,44	0,70	,000
It_weekdays	2,12	0,56	2,35	0,73	,002
It_weekends	2,28	0,64	2,53	0,65	,001
Studying	2,04	0,74	2,61	0,71	,000

Table 2 shows the coefficients of correlation between physical activity and demographic, social, psychological variables, variables to assess the physical environment and sedentary habits among respondents of both gender. From the review of the table can be seen that the male respondents is determined low statistically significant positive correlation (ranging from .188 to .225) between physical activity and the variables: living place and time spent on watching TV on weekdays. Moderately positive statistically significant correlation (ranging from .320 to .421) is established between physical activity and the variables: Parents support, Peer support, Perceived benefits of physical

activity and Perceived barriers to physical activity. Among female respondents is determined low statistically significant positive correlation (ranging from .171 to .265) between physical activity and Monthly income, Perceived barriers to physical activity, Parents support, Peer support, Neighbourhood safety and Access to local facilities. Moderately positive statistically significant correlation among female respondents is found between physical activity and the variable: number of objects in the environment ($r=.314$; $p=0.00$).

Among respondents of both gender statistically significant correlation is not determined in the variables: father's education, mother's education, if the father practiced sport and if the mother practiced sport and sedentary habits (watching TV, computer use, studying). Among male respondents statistically significant correlation is not determined in the variables: monthly income in the family, number and access to sports object in the environment. Among female respondents statistically significant correlation is not determined in the variables: living place, perceived benefits to physical activity and time spent on watching television on weekends.

Table 2. Correlations between Physical Activity and various factors using Spearman's Rho

Variable	Males	Females
Money	-,044	,245**
Education-father	-,045	,068
Education-mother	-,144	-,029
Father_sport	,176	-,090
Mother_sport	,084	,083
Living place	,255**	,150
Benefits	,320**	,101
Barriers	-,334**	-,171*
Parental support	,421**	,256**
Frinds support	,374**	,265**
Environment safety	,188*	,180*
Environment objects	,132	,314**
Assessible objects	,152	,178*
Tv_weekdays	,176	-,050
Tv_weekedns	,222*	-,050
It_weekdays	-,001	-,064
It_weekedns	,125	,145
Studying	,153	-,076
Note. Significance, * $p < .05$, ** $p < .01$		

In order to determine how the multivariable affect demographic, psychological, social factors, variables for assessment the physical environment, it is applied the hierarchical regression analysis. The regression results are shown in the Table 3. The first regression equation explains 9,3% ($p < 0.001$) of the total variability of the criterion variance, with a statistically significant impact on sports and living place. With the inclusion of the three variables for assessing the quality and safety of the settlement in the second step the amount of explained variance increases to 22.5% ($p < 0.001$), and the coefficients of the linear relation in the equation for this system of 10 predictors with level of the physical activity is $R = 0.474$ ($F = 7,128$; $p < 0.001$). Environment safety ($\beta = ,265$, $p < 0.001$), objects number in the environment ($\beta = ,164$, $p < 0.023$) and assess to the sports objects ($\beta = ,228$, $p < 0.012$) are important that statistically significant have influence on the criterion physical activity variable. By including both social variables in the third step the amount of the explained variance increases to 38.7% ($p < 0.001$). Parental social support ($\beta = ,357$, $p < 0.000$) and friends social support ($\beta = ,186$, $p < 0.003$) are important determinants which statistically significant have influence on the criterion physical activity variable. By including the psychological variables in the fourth block the amount of the explained variance increases to 41.9% ($p < 0.001$). The overall predictors system statistically significant have influence only on variable perceived barriers to physical system ($\beta = -,187$, $p < 0.001$). After inclusion of the fourth block of psychological variables can be seen that there is a statistically significant influence of the variable if the father practiced sport. On the other hand after the inclusion of the fourth block of psychological variables, the variable safety of the environment and assess to sports objects in explaining the variance in physical activity in the final regression equation become statistically insignificant. On the basis of the results it can be concluded that the statistically impact on the safety variables of the environment and the assess to sports objects are result of colinearity of the influence of other variables in this population group.

Table 3. Hierarchical regression analyses explaining PA

Variable	β	Partial r	β_1
Demographics	R = 0,305 R² = 0,093**		
Gender	-,126	-,114	-,022
Money	,073	,068	-,013
Father -education	-,008	-,008	,006
Mother-education	,018	,015	-,063
Father-sport	,000	,000	,310***
Mother-sport	,131*	,129	,156**
Living place	,188**	,169	,187**
Environment	R = 0,474 R² = 0,225***		
Safety-environment	,265***	,220	,025
Objects-environment	,164*	,144	,236***
Assess-objects	,228*	,160	,064
Social	R = 0,622 R² = 0,387***		
Parents support	,357***	,313	,293***
Peer support	,186**	,186	,177**
Psychological	R = 0,648 R² = 0,419***		
Perceived benefits of physical activity	,117	,120	,117
Perceived barriers of physical activity	-,187**	-,209	-,187**
Note. Partial r – coefficient of partial correlation; β – standardized partial regression coefficient; β_1 – value of β -coefficient in the last equation analysis; R – multiple correlation coefficient; R ² – change of the coefficient of determination;			
Significance, * p < .05, ** p < .01, *** p < .001.			

DISCUSSION

The explanation how the factors have influence on behavioral change is crucial in the preparation of interventions, strategies and educational programs that will contribute to increasing physical activity levels among student population (Sallis et al., 2000; Trost et al., 1997). In this study are researched the demographic, social and psychological variables in order to understand their influence on the change of physical activity among the student population of the University "St. Cyril and Methodius" in Skopje.

Although in the world on this topic are realized many researches in many countries (different geographic areas), the question arises whether the results of these studies can be generalized to the population of the Macedonian students who have their own cultural-social, religious and other specifics. The result obtained in our research somewhat overlap with the results obtained from the international researches.

Most of the current researches point that the level of the physical activity among girls is less unlike boys (Macera et al. 2005; Muntner et al. 2005; Dominguez-Berjon et al., 1998; Ammouri et al., 2007; Higgins, Gaul, Gibbons, & Van Gyn, 2003; Kristjansdottir & Vilhjalmsjon, 2001; Loucaides et al., 2007; Raudsepp, 2006; Sherrick-Escamilla, 2007; Shi et al., 2006; Vilhjalmsjon & Thorlindsson, 1998; Wu & Jwo, 2005). The results of our study also point that boys show significantly higher levels of physical activity in relation to girls. Also, boys perceive greater benefits from physical activity, perceive greater social support from friends and parents, consider that the environment where they live is safe and that they can easily reach the sports objects and places where they can exercise and practice sports near their home. Girls unlike boys spend more time on studying and watching TV, computer use in the weekdays and weekends.

Social support from parents and peers statistically significant have influence on the physical activity of students. The research has shown that boys perceive greater social support from parents and peers unlike girls. Previous research also indicates that participation in joined activities, organizing activities, providing transport, transferring positive attitudes and values, encouragement by parents and peers are associated with increased physical activity (Sallis, Taylor, Dowda, Freedson, & Pate, 2002; Saxena, Borzekowski, & Rickert, 2002; Taylor et al., 2002; Vilhjalmsjon & Thorlindsson, 1998).

Other features of the family such as: living place, socioeconomic status, parents education can have influence on physical activity among students. The results of our research indicate that the monthly income of the family have a statistically significant correlation with the physical activity of the female respondents. The influence on the monthly income on physical activity is probably a result of costs related to transport to sports objects, fitness center membership, sports equipment and so on. Most of the girls at this age if they practice to do some physical activity, they want to practice the same in some sports or fitness club, unlike boys who have spontaneous physical activity outdoors and they use the external facilities more. Also, the research results

indicate that students of both gender who come from rural areas are more physically active.

Sports tradition in the family (parent as a model) has a major impact on physical activity among respondents from both gender, that is confirmed in this research. Research indicates that there is a strong level of "familial aggregation" in physical activity which means that individuals tend to be quite similar to other family members in their customary physical activity levels (Seabra et al., 2008). Whereas shared genetic characteristics are certainly an important contributor to common physical activity patterns, other characteristics of the family climate surrounding physical activity exert an even greater influence. The results from Framingham Heart Study indicate that children of active parents have almost 6 times more probability to be physically active compared to children of inactive parents (Moore L.L. et al. 1991).

There are two cognitive variables that can determine the level of physical activity, perceived barriers and perceived benefits. Perceived benefits have positive influence, while the perceived barriers have negative on the level of physical activity (Buckworth i Dishman 1999). The research result point to that the degree of the perceived barriers are in negative relation with the physical activity among respondents of both gender. This is confirmed in this research by Stucky, DiLorenzo, Tappe, Duda, Menges, Zakarian (Stucky-Ropp and DiLorenzo 1993; Tappe, Duda, Menges-Ehrwald 1990; Zakarian et al. 1994). The dominant barrier among students of both gender is the lack of time as confirmed in several so far researches (Allison et al. 1999b, Grubbov et al. 2002; Gyurcsik et al., 2004). In this research is not determined the statistically significant impact on the perceived benefits and physical activity, indicating that regardless to how much are the respondents physically active they on similar way perceive the same benefits.

In this research it is not determined the statistically significant correlation between the sedentary habits (watching TV, computer use and studying) and physical activity. The research results show that large percent of the respondents of both gender on the weekdays and weekends spend more hours working on electronic media which is worrying fact. The research has shown that the chances an adolescent to have metabolic syndrome, risk factors for future cardiovascular diseases or type 2 diabetes increase proportionally with each additional hour of watching TV, regardless of physical activity (Mark A.E., et al. 2008).

The research results show that the Macedonian students of both gender, the vicinity and access to sports objects are in positive correlation with physical activity. This is confirmed in many previous researches realized on adolescents (Butcher 1985; Stucky-Ropp and DiLorenzo 1993).

On the basis of the above stated it can be concluded that the required preparation of a national plan and a program to promote physical activity in order to help students to change unhealthy habits and increase physical activity, and thus to improve their health.

The main promoter of this plan and program to promote physical activity among student population should be the universities in the Republic of Macedonia in cooperation with the Ministry of Education, local authorities and non-governmental organizations. For this purpose there need to be a new concept that will assume the defined and completely rebuilt and unified academic-educational system, sports competition and sports-recreational activity of students with financial, material, spatial and programmatic commitments defined as the governing bodies of the faculties and universities, the Ministry of education and Science in the part of its commitment providing the budget. Certainly this means primarily providing the necessary means for achieving the educational program, scientific research in the field of tuition and sports activities, and providing the adequate conditions for specialization of staff in line with higher international standards in the field of tuition and sports.

CONCLUSION

On the basis of the obtained results can be concluded that boys unlike girls show significantly higher level of physical activity. Respondents of both gender who have lower level of perceived barriers, perceive greater social support from friends and parents, have access to sports objects and have higher level of physical activity.

The education of parents for both gender is correlated with the physical activity. The monthly income of the family have a statistically significant correlation with the physical activity only for female respondents. Sporting tradition in the family has a major impact on physical activity among respondents of both gender. The safety of the environment is positively correlated with physical activity among respondents of both gender. The number, vicinity and access to the sports objects are positively correlated with

physical activity for female respondents. For both gender it is not determined the significant relation between sedentary habits (watching TV, computer use, studying) and physical activity.

The research results point to the importance of developing a national plan and a program to promote physical activity in order to help students to change unhealthy habits and increase physical activity, and thus to improve their health.

REFERENCES

World Health Organization; Global strategy on diet, physical activity and health. 2004.

World Health Organization. (2010). *Global recommendations on physical activity for health*.

Misigoj Durakovic M.(2008).*Kinantropologija; Bioloski aspekti tjelesnog vježbanja*. Kinezioloski fakultet Sveucilista u Zagrebu.

Dzepina, M., Cavlek. T.(2004). Zdravstvena zastita studenata. *Medix*, 54/55, 151-4.

Mandac V et al. (2001). The influence of physical activity and knowledge nutrition on nutritional status of the twelve years old. In: International Conference EUSHM, Programme and Abstracts Book: P12, Budapest.

Wallace LS et al.(2000). Characteristics of exercise behavior among college students: application of social Cognitive theory to predicting stage of change. *Prev Med*31, 494-505

Sallis, J.F., B.G. Simons-Morton, E.J. Stone, C.B. Corbin, L.H. Epstein, N. Faucette, R.J. Iannotti, J.D. Killen, R.C. Klesges, C.K. Petray, T.W. Rowland, and W.C. Taylor. (1992). Determinants of physical activity and interventions in youth. *Med. Sci. Sports Exercise*, 24(6 Suppl), S248-S257

Sallis, J. F., Prochaska, J. J., & Taylor, W. C. (2000). A review of correlates of physical activity of children and adolescents. *Medicine and science in sports and exercise*, 32(5), 963-975.

Pate, R. R., Trost, S. G., Dowda, M., Ott, A. E., Ward, D. S., Saunders, R., et al. (1999). Tracking of physical inactivity, and health-related physical fitness in rural youth. *Pediatric Exercise Science*, 11, 364-376.

Cavill, N., & Biddle, S. (2003). The determinants of young people's participation in physical activity, and investigation of tracking of physical

activity from youth to adulthood. In A. Giles(Ed.), *A lifecourse approach to coronary heart disease prevention: Scientific and policy review* (pp. 183-197). London: National Heart Forum.

Gontarev S. (2008) The Influence of Some, Environment, Psycho-social and Demographic factors on Physical Activity among Students Between the Ages of 15 and 18. Unpublished doctoral dissertation, Ss. Cyril and Methodius University in Skopje, Faculty of Physical Education, Sport and Health, Skopje, Macedonia..

Kalac, R., Gontarev, S., Velickovska, L.A. (2014) Perceived barriers to physical activity among Macedonian adolescents, *Research in Physical Education, Sport and Health*, 3(2), 51-57.

Booth, M. L., Okely, A. D., Chey, T., & Bauman, A. (2001). The reliability and validity of the physical activity questions in the WHO health behaviour in schoolchildren (HBSC) survey: A population study. *British Journal of Sports Medicine*, 35, 263-267.

Currie, C., Samdal, O., Boyce, W. & Smith, B. (Eds.) (2002). *Health Behaviour in School-aged Children: a World Health Organization Cross-National Study*. Research Protocol for the 2001/02 Survey. Edinburgh: Child and Adolescent Health Research Unit, University of Edinburgh.

Inchley, J., Kirby, J., & Currie, C. (2008). *Physical Activity in Scottish Schoolchildren* (PASS) Project: Physical activity among adolescents in Scotland: final report of the PASS study. Child and Adolescent Health Research Unit: The University of Edinburgh

Macera, C.A., Ham, S.A., Yore, M.M., Jones, D.A., Ainsworth, B.E., Kimsey, C.D. et al. (2005). *Prevalence of physical activity in the United States: Behavioral Risk Factor Surveillance System, 2001*, Preventing Chronic Disease.

Muntner, P., Gu, D., Wildman, R. P., Chen, J., Qan, W., Whelton, P. K., He, J. (2005). Prevalence of Physical Activity Among Chinese Adults: Results From the International Collaborative Study of Cardiovascular Disease in Asia. *American Journal of Public Health*, 95(9).

Domínguez-Berjón, M. F., Borrell, C., Nebot, M., Plasčncia, A. (1998). Leisure time physical activity and its association with sociodemographic variables and other health behaviours. *Lunes 1 Junio*, 12 (3), 100 – 109.

Ammouri, A. A., Kaur, H., Neuberger, G. B., Gajewski, B., & Choi, W. S. (2007). Correlates of exercise participation in adolescents. *Public Health Nursing*, 24, 111–120.

Higgins, J. W., Gaul, C., Gibbons, S., & Van Gyn, G. (2003). Factors influencing physical activity levels among Canadian youth. *Canadian Journal of Public Health, 94*, 45–51.

Kristjansdottir, G., & Vilhjalmsson, R. (2001). Sociodemographic differences in patterns of sedentary and physically active behavior in older children and adolescents. *Acta Paediatrica, 90*, 429–435.

Loucaides, C. A., Plotnikoff, R. C., & Bercovitz, K. (2007). Differences in the correlates of physical activity between urban and rural Canadian youth. *The Journal of School Health, 77*, 164–170.

Raudsepp, L. (2006). The relationship between socioeconomic status, parental support and adolescent physical activity. *Acta Paediatrica, 95*, 93–98.

Sherrick-Escamilla, S. (2007). *Factors affecting self-reported physical activity in children aged 10–12*. Unpublished doctoral dissertation, Wayne State University, Detroit, Michigan, USA.

Shi, Z., Lien, N., Kumar, B. N., & Holmboe-Ottesen, G. (2006). Physical activity and associated sociodemographic factors among school adolescents in Jiangsu province, China. *Preventive Medicine, 43*, 218–221.

Vilhjalmsson, R., & Thorlindsson, T. (1998). Factors related to physical activity: A study of adolescents. *Social Science Medicine, 47*, 665–675.

Wu, T. Y. (1999). *Determinants of physical activity among Taiwanese adolescents: An application of the health promotion model*. Unpublished doctoral dissertation, University of Michigan, Ann Arbor, Michigan, USA.

Sallis, J.F., Taylor, W.C., Dowda, M., Freedson, P.S. & Pate, R.R. (2002). Correlates of vigorous physical activity for children in grades 1 through 12: comparing parent-reported and objectively monitored physical activity. *Pediatric Exercise Science, 14*, 30-44.

Taylor, W. C., Sallis, J. F., Dowda, M., Freedson, P. S., Eason, K., & Pate, R. R. (2002). Activity patterns and correlates among youth: Differences by weight status. *Pediatric Exercise Science, 14*, 418-431.

Saxena, R., Borzekowski, D. L. G., & Rickert, V. I. (2002). Physical activity levels among urban adolescent females. *Journal of Pediatric & Adolescent Gynecology, 15*, 279-284.

Moore, L.L., Lombardi D.A., White, M.J., Campbell, J.L., Oliveria, S.A., Ellison, R.C. (1991). Influence of parents' physical activity levels on activity levels of young children. *J Pediatr, 118*, 215-219.

Stucky-Ropp, R.C., & DiLorenzo, T.M. (1993). Determinants of exercise in children. *Preventive Medicine*, 22,880–889.

Tappe, M.K., Duda, J.L, Menges-Ehrwald, P. (1990). Personal investment predictors of adolescent motivation orientation toward exercise. *Canadian Journal of Sport Sciences*, (15), 185–192.

Zakarian, J.M., Hovell, M. F., Hofstetter, C.R., Sallis, J.F., & Keating, K.J. (1994). Correlates of vigorous exercise in a predominantly low socio-economic status and minority high school population. *Preventive Medicine*, 23(3), 31.

Mark, A.E., Janssen, I.(2008). Relationship between screen time and metabolic syndrome in adolescents. *J Public Health (Oxf)*,30, 153-160.

Allison, K.R., Dwyer, J.M., Makin, S. (1999b) **Perceived barriers to physical activity among high school students**. *Preventive Medicine* 28, 608-615

Grubbs, L., Carte,r J. (2002) **The relationship of perceived benefits and barriers to reported exercise behaviors**. *Family & Community Health* 25(2), 76-84

Gyurcsik, N.C., Bray, S.R., Brittain, D.R. (2004) **Coping with barriers to vigorous physical activity during transition to university**.*Family & Community Health* 27(2), 130-142.

Seabra, A.F, Mendonça, D/M, Thomis, M.A, Peters, T.J, Maia, J.A. (2008). Associations between sport participation, demographic and socio-cultural factors in Portuguese children and adolescents. *Eur J Public Health*, 18:25–3

Kuzman, M et al. (2004). Bolesti srca i krvnih zila – rizicne navike u djece i mladih. *Medix*56/57, 73-7.

Huddleston, S et al. (2002). Physical activity behavior andattitudes toward involvement among physical education, health, and leisure Services pre-professionals. *College Student Journal*,36(4), 555-73.

Redefining of criteria of the test for estimation of motor knowledge

Damir Bavčević, Đurđica Miletić

Faculty of Kinesiology, University of Split, Croatia

ABSTRACT

This research focuses on a metric way of research of the newly-constructed polygon, motor skills and motor abilities test which is anthropologically based on coordination, velocity, ball manipulation, precision and ambidexterity. Sample of participant consisted of 28 male subjects aged 21 to 24. The results show that the polygon with the segmented scale of evaluation may be a good assessing instrument and it should be additionally researched on a greater number of subjects and in groups of different age in order to establish norms and justify its application in kinesiological practice.

Key words: polygon, motor skills, students

INTRODUCTION

Polygon is a complex motor movement which, with adequate kinesiological research procedures, may become an assessment instrument as well (Žuvela, Kezić, Miletić, 2011). Subject and purpose of the assessment will greatly depend on movement components which form the polygon, but it will remain rather multidimensional in anthropological space. The process of converting the polygon into a purposeful and clear kinesiological assessment instrument is a complex kinesiometric procedure which must be standardised and evaluated, as well as validly applicable in practice. Finally, it is possible to obtain assessment instrument which would be simple to use, short-term and efficient, and which would have form of competition and comparison which is crucial for kinesiological assessment processes.

In order for a polygon to become an adequate kinesiological assessment instrument great assessing features and a system of standardising, proved by research, must be included. Previously to the mentioned a range of pilot research must be conducted with the aim of establishing the best form of polygon for the aimed age group.

The Likert scale was most frequently used in previous research for estimation of simple motor knowledge (Miletić, Katić, Maleš, 2004) using marks from one to five, and a segmented scale (Kezić, Miletić, 2011) was recently used for more complex movement structures. In the segmented scale complex motor movement is divided into smaller units with a previous set of criteria, usually on simple assessment scales, which is later summed and formed into a single scale which can be used for a relatively and objectively estimation of complex motor movement.

School practice shows that there are no practical assessment instruments which would objectively estimate motor knowledge of ball manipulation which requires precision, coordination, ambidexterity and velocity. Since in kinesiological practice in younger age groups there is a tendency towards movement exercising which integrate more motor abilities, knowledge and skills which would, as such, have a greater influence on multiple development of children, it is important to find new solutions for assessment and evaluation of movement progress. Polygon is one of possible solutions of assessment of an integrated space of motor knowledge and motor abilities, so creating quality assessment instruments – polygons, would contribute to kinesiological practice.

From the kinesiometric point of view, it is advisable to conduct a research on the way the same motor structure can change by different assessment procedures, in this case by determining different assessment criteria. By accessing positive and negative components of different assessing criteria of a particular test it is possible to reach a version which would have, as a kinesiological test, the complete objectivity and as such it would be applicable in kinesiological practice.

This research focuses on a metric way of research of the newly-constructed polygon, motor skills and motor abilities test which is anthropologically based on coordination, velocity, ball manipulation, precision and ambidexterity. Since it is about motor and functionally complex movement before detailed kinesiometric research which might be used for defining the useful test assessment and for norms for a particular age, it is necessary to conduct a

range of other pilot research which will justify such extensive research. This research is one of the pilot ones and it focuses on emphasizing the problem of defining objective and applicable test criteria as well as their redefining with the aim of setting a platform for wider kinesiometric research of the newly-constructed polygon.

Therefore, the emphasized aim of the research is (1) to assess some metric characteristics (objectivity, sensitivity and homogeneity) of the newly-constructed polygon on the Likert scale from one to five; (2) to redefine the test criteria by creating a new, segmented scale of total numeric value from zero to eight, based on the established negativity of this assessment; (3) to compare advantages and disadvantages of both applicable assessment scales.

WORK METHODS

The research has been conducted on a sample of 28 male subjects, regular first year students of kinesiology at the age from 21 to 24, all attending Graduate Study of kinesiology at the Faculty of Kinesiology, course Motor Learning. Three assessors evaluated the polygon in the first phase on the Likert scale from one to five. In the second phase of the research, five assessors evaluated the polygon on the segmented scale ranging from zero to eight.

The assessment criteria were previously determined in both research phases. Afterwards the assessors evaluated the subjects without a possibility of additional agreement and mutual consulting.

In the first phase of the research the polygon consisted of two parallel benches, and on one side there were 19 square fields, dimensions 20 x 20, set on the distance of 20 cm from the benches. First field was set at the beginning of the longitudinal line of the bench, and the other fields were set on the following distances: 30 cm, 30 cm, 10 cm, 10 cm, 30 cm, 30 cm, 30 cm, 30 cm, 30 cm, 10 cm, 30 cm, 30 cm, 30 cm, 10 cm, 10 cm, 10 cm, 30 cm. Subject's task was to manage the rhythmic gymnastics ball by moving in maximum speed and hitting only the marked fields. Ball managing is started with the right hand until the last field where the subject turns in 180° and manages the ball in the previously described way till the starting point with the left hand. Evaluating was conducted in the following way: the maximum mark was 5 points and for every five mistakes one point was taken away. The term mistake refers to missing the field and falling off the bench.

In the second phase of research the polygon was divided in 4 parts which

were done in a row. Each task was separately evaluated by the assessors. Mark 2 went for each part of the polygon which was entirely well done; mark 0 went to each part the polygon which was poorly done; mark 1 went to each part of the polygon which was partially done. First part of the polygon consisted of the bench and along its right side, at the distance of 20 cm, there were 9 square fields, dimensions 20 cm x 20 cm. First field was set at the beginning of the longitudinal line of the bench, and the other fields were set on the following distances: 20 cm, 20 cm, 20 cm, 20 cm, 10 cm, 20 cm, 10 cm, 20 cm. Subject's task was to manage the rhythmic gymnastics ball by moving in maximum speed and hitting only the marked fields. Subject got mark 2 if he did the entire process without a mistake, mark 1 if he did from 1 to 5 mistakes and mark 0 if he did more than 5 mistakes. The term mistake refers to missing the field and falling off the bench. Second part of the polygon consisted of shooting the basket with a basketball from the penalty line. Subject had two attempts, and the number of scores equals to the mark. Third part of the polygon was identical to the first one with the difference of managing the ball with the left hand. Fourth part of the polygon consisted of hitting the basketball set on a cone with a tennis ball from the distance of 3 m. The task was done once. Subject gets mark 2 if he hit the basketball, mark 1 if he hit the cone and mark 0 if he missed both the ball and the cone.

Methods for data analysis were chosen according to previously set aims of the research. With the aim of analysing metric characteristics of the polygon: descriptive statistic parameters were calculated with the aim of analysing sensitivity: arithmetic mean (AM), standard deviation (SD), minimum results (MIN), maximum results (MAX), and distribution normalities were tested by the Kolmogorov – Smirnov test (KS). The Cronbach alpha coefficient was calculated with the aim of analysing objectivity of the assessors. First main component unit was calculated with the aim of analysing homogeneity.

RESULTS AND DISCUSSION

Table 1. Descriptive statistics of the test evaluated on the Likert scale.

	Mean	Min	Max	SD
S1	4,00	2,00	5,00	0,82
S2	3,71	1,00	5,00	0,98
S3	4,07	2,00	5,00	0,86

Table 2. Correlation between the assessors, *Crombach alpha* coefficient (ALPHA) and *inter item* correlation (IIR) of the test evaluated on the Likert scale.

	S1	S2	S3	CA	IIR
S1	1,00	0,65	0,69	0,87	0,69
S2	0,65	1,00	0,73		
S3	0,69	0,73	1,00		

Table 3. Structure of the latent dimension in space of units of the test assessors evaluated on the Likert scale.

	Factor
S1	-0,87
S2	-0,89
S3	-0,91
Expl.Var	2,38
Prp.Totl	0,79

Table 4. Descriptive statistics of the test evaluated on the segmented scale.

	Mean	Min	Max	SD
S1	3,20	1,00	4,00	1,03
S2	3,60	1,00	6,00	1,43
S3	3,20	1,00	5,00	1,32
S4	3,30	1,00	5,00	1,42
S5	3,20	0,00	5,00	1,62

Table 5. Correlation between the assessors, *Crombah alpha* coefficient (CA) and *inter item* correlation (IIR) of the test evaluated on the segmented scale.

	S1	S2	S3	S4	S5	CA	IIR
S1	1,00					0,98	0,95
S2	0,89	1,00					
S3	0,95	0,93	1,00				
S4	0,94	0,94	0,98	1,00			
S5	0,90	0,90	0,97	0,99	1,00		

Table 6. Structure of the latent dimension in space of units of the test assessors evaluated on the segmented scale.

	Factor
S1	-0,96
S2	-0,96
S3	-0,99
S4	-0,99
S5	-0,98
Expl.Var	4,76
Prp.Totl	0,95

According to the results in Table 1, manipulative polygon may be estimated by a sensitivity test. In all three assessors the registered KS test does not deviate significantly from the Gaussian curve on the level of error of 0.05 (for: $d > 0.25$ when $N=27$) and as such they have satisfactory sensitivity. The assessors have equal middle values in evaluating the polygon (3.71-4.07) and the assessment range from 1 to 5 for the other assessor, while first and third assessor lowered the assessment range from 2 to 5. It is already clear from these descriptive indicators that there are certain disadvantages in determining criteria of the marks and in determination of assessors on a particular level after the realisation of a subject. Number of assessors was increased in order to decrease the level of subjectivity of an assessor in final decision during the second phase of research.

In Table 4 the same parameters for evaluation of sensitivity test are shown but on the segmented scale of evaluation and including five assessors. Comparison of parameters indicates that there are no significant differences in sensitivity test regardless the applied criteria. In conclusion, the newly-constructed polygon is a test appropriate for subjects such as students, and to apply it on school age children the research should be conducted on such population.

According to the parameters for evaluation of objectivity (Table 2) there is a decrease in test objectivity, estimated on the Likert scale in relation to the test evaluated on the segmented scale (Table 5). Correlations between the assessors on the Likert scale range between 0.65 – 0.73 while on the segmented scale they are significantly higher (0.89-0.99) which implies clearly set criteria of assessment.

Comparison of the parameters of objectivity in Tables 2 and 4 shows that the criteria made on the segmented scale were more acceptable from the kinesiometric point of view. Even though the segmented summed scale is of a wider range than the Likert's one, the assessors easier come to the same conclusions regarding the realisation of subjects itself, because they are focused on parts (segments) of motor structure itself, and the evaluation of success for each segment reduced to the form *successful, unsuccessful, partially successful* also enables less educated assessors a more simple and more accurate assessment. On the other hand, the concentration of the assessors in evaluation of motor knowledge represents a significant and restricted factor and the range of three criteria on which the assessors must decide on the segmented scale, proved to be better than the range of five criteria used by the assessors on the Likert scale. At the same time, the criteria developed on the Likert or on the segmented scale influence sensitivity change of the test itself.

Latent dimension in variables space of the assessors (Table 3) on the Likert scale explains 79% of the total variance of the units system, while on the segmented scale (Table 6) that part totals even 0.95 which also manifests through high and homogeneous projection of all assessors on mutual subject of evaluation (0.96-0.99). From comparing the data in Tables 3 and 6 it is clear that higher homogeneity of test units is achieved on the segmented scale.

CONCLUSION

Polygon is a desirable form of a kinesiological assessing instrument. In younger school children, and especially during the process of motor learning, the polygon, as a complex motor structure, offers clear and motivating feedback. Conducted pilot research established that newly-constructed polygon for evaluation of motor knowledge and motor abilities, which are anthropologically based on coordination, of velocity, ball manipulation, precision and ambidexterity may be better defined on the segmented scale than on the Likert scale of evaluation. The same was established after obtaining poor metric characteristics of objectivity and homogeneity on the Likert scale, after which the test criteria was redefined in form of segmented scale and in the second phase of the research evaluating of the same polygon was repeated on a different scale. In conclusion, the polygon with the segmented scale of evaluation may be a good assessing instrument and it should be additionally researched on a greater number of subjects and in groups of different age in order to establish norms and justify its application in kinesiological practice.

REFERENCES

Bozanic, A., & Miletic, Đ. (2011). Differences between the sexes in technical mastery of rhythmic gymnastics. *Journal of Sports Sciences*, 29 (4), 337-343.

Miletić, Đ., Katić, R., & Maleš, B. (2004). Some Anthropologic Factors of Performance in Rhythmic Gymnastics Novices. *Collegium Antropologicum*, 28 (2), 727-737.

Žuvela, F., Božanić, A., & Miletić, Đ. (2011). Polygon – A new fundamental movement skills test for 8 year old children: construction and validation. *Journal of sports science and medicine*, 10, 157-163.

Razlike između adolescenata koji odustaju ili ustraju u bavljenju organiziranom kineziološkom aktivnošću

Barbara Gilić¹, Boris Milavić¹, Veronika Jurčić¹, Lucija Maglica¹, Ante Županović²

¹Faculty of Kinesiology, University of Split, Croatia

²Faculty of Education and Rehabilitation Sciences, University of Zagreb, Croatia

ABSTRACT

The aim of this research was to determine the frequency of groups of adolescents who gave up or were continuously active in organized kinesiological activity involvement. The research was conducted on 601 female and male students of 7th and 8th grades of elementary schools coming from two Dalmatian counties. The group of measured variables consisted of the following variables: involvement in organized kinesiological activity, sport motivation orientation, perceived sports competence, kinesiological engagement, general self-esteem and perceived body and health image. The frequencies of male and female students, according to the affiliation to certain group of organized kinesiological activity involvement, were different: female students gave up more often than male students. Differences according to gender were determined between the groups of those who gave up and those who were continuously active, similar to those determined using the general sample of female and male students. Within each gender group of examinees, differences between the groups of those who gave up and those who were continuously active were determined, in the sense that the first mentioned group had lower results in the following measures: orientation towards sport motivation assignment, perceived sport competence and kinesiological engagement, passive sports preoccupation. Regarding the sub-sample of students, the group of those who gave up had more strongly expressed perception of their own health image, in relation to continuously active pupils. In both sub-samples of male and female students the differences in the measures of ego sport motivation orientation, general self-esteem and body image were not determined.

Keywords: sport motivation orientation, perceived sport competence, self-esteem, kinesiological engagement, body image, health image

UVOD

Sedentarni način života adolescenata nije samo predmet mnogobrojnih znanstvenih istraživanja već je postao dio svakodnevnih rasprava ne samo u stručnim i znanstvenim časopisima, nego i u školama, školskim ambulantomama, dnevnim novinama i ostalim medijima. Svakim danom sve veći broj djece i adolescenata sve više vremena provode za stolnim i prijenosnim računalima, ispred televizora, koristeći moderne mobilne uređaje i ostala komunikacijska informatička pomagala i sve se više virtualno druže putem društvenih mreža, dok stručnjaci iz različitih područja, ukazuju na važnost organizirane i neorganizirane kineziološke angažiranosti. Porastao je i broj radova iz područja kineziološke psihologije koji ukazuju na mnogobrojne uzroke kontinuiranog opadanja kineziološke aktivnosti, a najveći se nalaze upravo u sve većoj informatizaciji društva (Kautiainen i sur., 2005). Osim istraživanja koja utvrđuju pozitivan odnos kineziološke angažiranosti i tjelesnog zdravlja, istraživanja podupiru i pozitivan učinak kineziološke angažiranosti i uključenosti u sport na psihološku dobrobit (Bidlle i sur., 2004).

Grgantov i sur. (2013) ističu kako je *odustajanje od organizirane kineziološke angažiranosti (sportske, plesne ili rekreativne aktivnosti)* adolescenata učestala pojava. U svom radu imali su za cilj utvrditi odnose između *motivacije u nastavi TZK* i pojave *odustajanja od organizirane kineziološke angažiranosti* adolescenata. Korištenjem diskriminacijske analize utvrdili su razlike između skupina *stalno aktivnih* i *odustalih* adolescenata po *motivaciji u nastavi tjelesne i zdravstvene kulture* na uzorku učenica, a nisu ih utvrdili na uzorku učenika. Skupinu *odustalih* od organizirane kineziološke angažiranosti kod djevojčica karakterizira viša izraženost *amotivacije u nastavi TZK*, dok skupinu *stalno aktivnih* učenica obilježava značajno viši stupanj *intrinzične motivacije* te dijelom i *ekstrinzične motivacije u nastavi TZK*. Milić i sur. (2011) utvrdili su kako učenici završnih razreda osnovnih škola imaju zamjetno izraženiju *intrinzičnu motivaciju* za sport nego *ekstrinzičnu motivaciju* za sport. Navode kako to predstavlja dobru predispoziciju za bavljenje *organiziranom kineziološkom aktivnošću* jer takvi adolescenti zadovoljstvo u sportu više nalaze u usvajanju i razvoju vještina te povećavanju osobnih sportskih kompetencija, nego u očekivanju, potvrđivanju ili dobivanju nagrade od strane drugih.

Milavić i sur. (2010) utvrdili su kako između učenica i učenika nema razlike u procjeni kompetentnosti na ljestvici *opće percipirane sportske kompetencije (PSK)*, dok je utvrđena značajna razlika na rezultatima ljestvice *specifične*

PSK na kojoj učenici imaju značajno više rezultate od učenica. Povišenjem stupnja izraženosti osobne sportske kompetencije za očekivati je kako kod adolescenta može doći i do razvoja općeg samopoimanja. U skladu s navedenim, percipiranu sportsku kompetenciju može se smatrati dijelom općeg samopoimanja pojedinca kojeg osoba stvara na osnovu iskustva. Richmond i Shaffer (prema Lindwall i Lindgren, 2005) navode kako će u odnosu između sporta i samopoimanja, sport poboljšati opće samopoimanje sudionika vježbanja samo ako su se vježbanjem razvile i bitne posredničke varijable – slika o tijelu i tjelesna samopercepcija. Lacković-Grgin (1994) definira tjelesno samopoimanje u jednom od dva moguća oblika kao stavove osobe o svom tijelu (emocije, predodžbe, percepcije i procjene funkcije svog tijela).

Pezelj i sur. (2015) su na učenicima završnih razreda osnovnih škola utvrdili značajne razlike za sve mjerene varijable psiholoških obilježja i kineziološke angažiranosti. Učenici imaju višu *opću i specifičnu percipiranu sportsku kompetenciju*, višu procjenu osobne *slike o tijelu* te višu *kineziološku angažiranost* od učenica. Učenice imaju višu procjenu *općeg samopoimanja i svoje percepcije zdravlja* od učenika. Milić i sur. (2011) utvrdili su kako između učenica i učenika završnih razreda osnovne škole postoje značajne razlike te učenici imaju višu *pasivnu zaokupljenost sportom, kineziološku angažiranost* i viši stupanj *specifične percipirane sportske kompetencije* od učenica. Dakle, precizno su utvrđene razlike u određenim psihološkim obilježjima i kineziološkoj angažiranosti po spolu ispitanika, ali nisu precizno utvrđene razlike po spolu između skupina adolescenata *odustalih* i *stalno aktivnih* te između skupina *odustalih* i *stalno aktivnih* unutar populacije jednog spola ispitanika. Stoga je cilj ovog istraživanja utvrditi razlike po spolu ispitanika u učestalosti pripadnosti pojedinoj skupini različitog statusa *organiziranog bavljenja kineziološkom aktivnošću*, potom utvrditi izraženost određenih obilježja (orijentacije motivacije za sport, kineziološke angažiranosti te psiholoških obilježja) u skupinama *odustalih* i *stalno aktivnih* ispitanika te utvrditi razlike izraženosti obilježja između tih skupina ispitanika (po spolu ili po statusu *organiziranog bavljenja kineziološkom aktivnošću*).

METODE

Uzorak ispitanika predstavlja 601 učenica i učenik 7. i 8. razreda osnovnih škola iz Splitsko-dalmatinske i Šibensko-kninske županije od čega je bilo 289 učenica i 312 učenika. Ispitanici nisu imali nikakav izraženiji strukturalni deformitet koji bi ograničio njihovo bavljenje sportom. Varijabla *organiziranog bavljenja kineziološkom aktivnošću* (u daljnjem tekstu OKA) utvrđena je na temelju dvaju pitanja o sadašnjem i nekadašnjem bavljenju organiziranom sportskom

ili plesnom aktivnošću i definira sadašnji status ispitanika, a koji je mogao biti: *stalno aktivni, odustali, nedavno aktiviran* ili *stalno neaktivan*. Varijable obilježja ispitanika su utvrđene ljestvicama: *kineziološke angažiranosti (KINEZ_ANGAŽIR)* i *pasivne zaokupljenosti sportom (PASIV_ZS)* (Milić, Grgantov i Milavić, 2011), *opće (OPĆA_SP_KOMP)* i *specifične (SPEC_SP_KOMP)* percipirane kompetencije za sport (Milavić, Guć i Miletić, 2010), *općeg (SAMOPOIMANJE)* i *tjelesnog (SLIKA_TIJELO)* samopoimanja (Samardžić, Bego i Milavić, 2011) te *percepcije slike učenika o svom zdravlju (SLIKA_ZDRAVLJE)* (Milavić i sur., 2012). Orijentacija motivacije za sport ispitanika utvrđena je upitnikom TEOSQ (Chi i Duda, 1995) koji mjeri *orijentaciju motivacije na zadatak (TASK_MOT)* i *orijentaciju motivacije na ego (EGO_MOT)*. Sve ljestvice i upitnici su primjenjeni u razrednim odjeljenjima učenika poštujući etička načela istraživanja malodobnih ispitanika. Za rješavanje postavljenih ciljeva istraživanja korišteni su statistički postupci za utvrđivanje razlika između deskriptivnih mjera skupina ispitanika po učestalosti pripadnosti pojedinoj skupini ispitanika različitog statusa *organiziranog bavljenja kineziološkom aktivnošću* (hi-kvadrat test) te za utvrđivanje razlika između skupina ispitanika po izraženosti pojedinih mjerenih obilježja ispitanika (t-test). Kako bi se mogli uspoređivati rezultati utvrđeni na ljestvicama s različitim brojem čestica, rezultat na svakoj od ljestvica izračunat je na način da su rezultati svih čestica pojedine ljestvice zbrojeni i podijeljeni s brojem čestica iste ljestvice.

REZULTATI I RASPRAVA

Tablica 1. Učestalost i razlike organiziranog bavljenja sportom učenica i učenika

SKUPINE FREKV.		UČENICE		UČENICI		X ² test
		%	FREKV.	%		
Organizirana kineziološka aktivnost	Odustali	133	46,02	92	29,49	X ² = 16,01*** SS = 3 p < 0,001
	Stalno aktivni	125	43,25	153	49,04	
	Nedavno aktivirani	11	3,81	14	4,49	
	Stalno neaktivni	20	6,92	53	16,98	
	UKUP- NO	289	100,00	312	100,00	

Legenda: FREKV. – učestalost ispitanika; % – postotak ispitanika; X² – koeficijent hi-kvadrat testa; SS – stupnjevi slobode; p= – razina značajnosti koeficijenta hi-kvadrat testa; *** – razina značajnosti koeficijenta od p < 0,001.

U tablici 1. prikazani su rezultati kategorizacije ispitanika u četiri skupine različitog statusa OKA. Učenice i učenici značajno se razlikuju po učestalosti pripadnosti pojedinoj skupini ispitanika. Znatno je viši postotak učenica u odnosu na učenike u kategoriji *odustalih* od OKA, a niži je u kategoriji *stalno neaktivnih*. Učestalost pripadnosti ispitanika u druge dvije kategorije je slična. Ovaj je nalaz različit u odnosu na istraživanje Grgantov i sur. (2013) koji su, na uzorku učenika iz manjih gradova Splitsko-dalmatinske županije, utvrdili kako po spolu ispitanika ne postoji razlika u učestalosti bavljenja OKA. U budućim istraživanjima preporuča se utvrditi ovisi li postotak onih koji se bave ili odustaju od bavljenja OKA o brojnosti stanovnika mjesta u kojima obitelji učenika žive.

Sve mjerne ljestvice primijenjene u ovom istraživanju imaju zadovoljavajuće mjerne karakteristike, vrlo slične onima koje navode njihovi autori.

Tablica 2. Značajnost razlika po spolu ispitanika skupine *odustalih* adolescenata

VARIJABLE	UČENICE (N-133)		UČENICI (N-92)		t-test	p=
	AS	SD	AS	SD		
TASK_MOT	3,88	0,79	3,73	0,95	1,29	0,20
EGO_MOT	3,37	0,99	3,24	1,11	0,94	0,35
OPĆA_SP_KOMP	2,98	0,83	3,33	0,85	3,10**	0,002
SPEC_SP_KOMP	2,72	0,72	3,11	0,88	3,63***	0,000
KINEZ_ANGAŽIR	2,02	0,73	2,67	0,95	5,81***	0,000
SAMOPOIMANJE	3,49	0,73	3,36	0,74	1,23	0,22
PASIV_ZS	2,08	0,90	3,16	1,00	8,41***	0,000
SLIKA_TIJELO	3,50	1,07	3,85	0,88	2,62**	0,009
SLIKA_ZDRAVLJE	3,89	0,83	3,71	0,93	1,51	0,13

Legenda: AS – aritmetička sredina; SD – standardna devijacija; t-test – koeficijent t-testa; p= – razina značajnosti koeficijenta t-testa; *, ** ili *** – razina značajnosti koeficijenta od $p < 0,05$, $p < 0,01$ ili $p < 0,001$.

U tablici 2. su prikazane razlike po spolu ispitanika u skupini onih koji su *odustali* od OKA. Nisu utvrđene razlike između učenica i učenika po njihovoj orijentaciji motivacije za sport što je sukladno nalazu Milavić i sur. (2010) na općem uzorku učenika i učenica. Što se tiče ostalih mjerenih obilježja utvrđene su značajne razlike između učenika i učenica na većini mjera izuzev u mjerama *općeg samopimanja* i percepcije *slike o tijelu*. U svim mjerama u kojima su utvrđene razlike *odustali* učenici imaju više rezultate od *odustalih* učenica. Ovi

nalazi su vrlo slični nalazu Milavić i sur. (2012) utvrđenom na općoj populaciji učenica i učenika uz iznimku što je u tom istraživanju utvrđena značajna razlika i u mjeri percepcije *slike o tijelu*.

Tablica 3. Značajnost razlika po spolu skupine *stalno aktivnih* adolescenata

VARIJABLE	UČENICE (N-125)		UČENICI (N-153)		t-test	p=
	AS	SD	AS	SD		
TASK_MOT	4,10	0,74	4,03	0,94	0,74	0,46
EGO_MOT	3,45	0,96	3,45	0,99	0,01	0,99
OPĆA_SP_KOMP	3,56	0,81	3,82	0,75	2,72**	0,007
SPEC_SP_KOMP	3,27	0,81	3,62	0,73	3,79***	0,000
KINEZ_ANGAŽIR	3,78	0,81	3,90	0,78	1,24	0,22
SAMOPOIMANJE	3,46	0,75	3,25	0,76	2,31*	0,022
PASIV_ZS	2,48	0,97	3,54	0,87	9,58***	0,000
SLIKA_TIJELO	3,43	1,10	3,73	0,98	2,43*	0,016
SLIKA_ZDRAVLJE	3,87	0,83	3,38	0,98	4,40***	0,000

Legenda: AS – aritmetička sredina; SD – standardna devijacija; t-test – koeficijent t-testa; p= – razina značajnosti koeficijenta t-testa; *, ** ili *** – razina značajnosti koeficijenta od $p < 0,05$, $p < 0,01$ ili $p < 0,001$.

U tablici 3. prikazane su razlike po spolu ispitanika u skupini onih koji su *stalno aktivni* u OKA. U toj skupini također nisu utvrđene razlike između učenica i učenika po njihovoj orijentaciji motivacije za sport, kao i u skupini odustalih. Što se tiče ostalih mjerenih obilježja utvrđene su značajne razlike između učenika i učenica na većini mjera izuzev u mjeri *kineziološke angažiranosti*. U većini mjera u kojima su utvrđene razlike *stalno aktivni* učenici imaju više rezultate od *odustalih* učenica izuzev u mjerama *općeg samopoimanja* i percepcije *slike o tijelu* u kojima učenice imaju više rezultate. Ovi nalazi su vrlo slični nalazima Milavića i sur. (2012) utvrđenima na općoj populaciji učenica i učenika, ali uz iznimku što u tom istraživanju nije utvrđena značajna razlika u mjeri *općeg samopoimanja*.

Zamjetno je u tablicama 2. i 3. kako je u sva četiri skupine ispitanika više izražena *intrinzična motivacija* za sport nego *ekstrinzična motivacija* za sport što potvrđuje nalaze Milić i sur. (2011).

Uspoređujući u tablicama 2. i 3. različitosti u utvrđivanju razlika po spolu ispitanika zamjetno je nekoliko „suprotnih“ rezultata. Utvrđene su

razlike po *kineziološkoj angažiranosti* u skupini *odustalih*, a nisu utvrđene u skupini *stalno aktivnih*. Stalno aktivne učenice i učenici imaju slične obrasce ponašanja u odnosu prema vježbanju i ne razlikuju se po svojoj kineziološkoj angažiranosti, dok su *odustali* učenici ipak kineziološki aktivniji od *odustalih* učenica. Također, utvrđene su razlike po percipiranom *općem samopoimanju* i *slici o zdravlju* u skupini *stalno aktivnih*, a nisu utvrđene u skupini *odustalih*. Stalno aktivni učenici za razliku od stalno aktivnih učenica imaju niže izražene i *opće samopoimanje* i percipiranu *sliku o zdravlju*. Ovaj nalaz nisko izražene *slike o zdravlju* u aktivnih učenika potvrđuje nalaze Milavić i sur. (2012) i djelomično potvrđuje njihove pretpostavke kako kineziološki aktivni učenici često koriste otvorene i neuređene terene za svoje sportske aktivnosti pa im se češće događaju različite ozljede i problemi sa zdravljem. Moguće je dodati, vjerojatno je kako su učenici skloniji češćem angažiranju u opasnijim kontaktnim sportskim igrama od učenica, pa i to može biti razlog za nižu procjenu zdravstvenog statusa svoga tijela.

Tablica 4. Značajnost razlika skupina učenica *stalno aktivne - odustale*

VARIJABLE	STALNO AKTIVNE (N-125)		ODUSTALE (N-133)		t-test	p=
	AS	SD	AS	SD		
	TASK_MOT	4,10	0,74	3,88		
EGO_MOT	3,45	0,96	3,37	0,99	0,64	0,52
OPĆA_SP_KOMP	3,56	0,81	2,98	0,83	5,69***	0,000
SPEC_SP_KOMP	3,27	0,81	2,72	0,72	5,74***	0,000
KINEZ_ANGAŽIR	3,78	0,81	2,02	0,73	18,28***	0,000
SAMOPOIMANJE	3,46	0,75	3,49	0,73	0,25	0,81
PASIV_ZS	2,48	0,97	2,08	0,90	3,42***	0,001
SLIKA_TIJELO	3,43	1,10	3,50	1,07	0,51	0,61
SLIKA_ZDRAVLJE	3,87	0,83	3,89	0,83	0,22	0,82

Legenda: AS – aritmetička sredina; SD – standardna devijacija; t-test – koeficijent t-testa; p= – razina značajnosti koeficijenta t-testa; *, ** ili *** – razina značajnosti koeficijenta od $p < 0,05$, $p < 0,01$ ili $p < 0,001$.

U tablici 4. prikazane su razlike skupina *odustalih* i *stalno aktivnih* učenica. Utvrđene su razlike po njihovoj *orijentaciji na zadatak* (TASK_MOT) motivacije za sport pri čemu stalno aktivne učenice imaju značajno višu

unutarnju, intrinzičnu motivaciju od skupine odustalih. S obzirom na ostala mjerena obilježja utvrđene su značajne razlike između skupina *odustalih* i *stalno aktivnih* učenica na mjerama *kineziološke angažiranosti, opće i specifične percipirane sportske kompetencije* i *pasivne zaokupljenosti sportom* pri čemu stalno aktivne učenice imaju sve navedene mjere značajne više od skupine odustalih učenica. Nisu utvrđene razlike u mjerama *općeg samopoimanja* i percepcije *slike o tijelu*. Ovi nalazi jasno pokazuju specifična obilježja *odustalih* učenica u odnosu na *stalno aktivne* učenice: nižu intrinzičnu motivaciju za sport, nižu percipiranu sportsku kompetenciju i kineziološku angažiranost te nisku pasivnu zaokupljenost sportom.

Tablica 5. Značajnost razlika skupina učenika *stalno aktivni – odustali*

VAR	STALNO AKTIVNI		ODUSTALI		t-test	p=
	(N-153)		(N-92)			
	AS	SD	AS	SD		
TASK_MOT	4,03	0,94	3,73	0,95	2,39*	0,018
EGO_MOT	3,45	0,99	3,24	1,11	1,55	0,12
OPĆA_SP_KOMP	3,82	0,75	3,33	0,85	4,64***	0,000
SPEC_SP_KOMP	3,62	0,73	3,11	0,88	4,91***	0,000
KINEZ_ANGAŽIR	3,90	0,78	2,67	0,95	10,89***	0,000
SAMOPOIMANJE	3,25	0,76	3,36	0,74	1,12	0,26
PASIV_ZS	3,54	0,87	3,16	1,00	3,14**	0,002
SLIKA_TIJELO	3,73	0,98	3,85	0,88	0,97	0,34
SLIKA_ZDRAVLJE	3,38	0,98	3,71	0,93	2,59**	0,010

Legenda: AS – aritmetička sredina; SD – standardna devijacija; t-test – koeficijent t-testa; p= – razina značajnosti koeficijenta t-testa; *, ** ili *** – razina značajnosti koeficijenta od $p < 0,05$, $p < 0,01$ ili $p < 0,001$.

U tablici 5. prikazane su razlike skupina učenika u odnosu na njihov status organiziranog bavljenja kineziološkom aktivnošću, skupina *odustalih* i *stalno aktivnih* učenika. Utvrđene su razlike između *odustalih* i *stalno aktivnih* učenika po njihovoj *orijentaciji na zadatak* (TASK_MOT) motivacije za sport pri čemu stalno aktivni učenici imaju značajno višu unutarnju, intrinzičnu motivaciju od skupine odustalih. S obzirom na ostala mjerena obilježja utvrđene su značajne razlike između skupina *odustalih* i *stalno aktivnih* učenika na mjerama *kineziološke angažiranosti, opće i specifične percipirane sportske kompetencije, pasivne zaokupljenosti sportom* i percepciji *slike o tijelu*. Stalno aktivni učenici

imaju sve navedene mjere značajne više od skupine odustalih učenika izuzev u mjeri percepciji *slike o tijelu* u kojoj odustali učenici imaju više rezultate. Nisu utvrđene razlike u mjerama *općeg samopoimanja* i percepcije *slike o tijelu*. Ovi nalazi jasno pokazuju specifična obilježja *odustalih* učenika u odnosu na *stalno aktivne* učenike: nižu intrinzičnu motivaciju za sport, nižu percipiranu sportsku kompetenciju i kineziološku angažiranost, nisku pasivnu zaokupljenost sportom te nižu percepciju slike o svom zdravlju.

Odustali učenici i učenice, iako se međusobno razlikuju (tablica 2.), u odnosu na *stalno aktivne* ispitanika istog spola imaju vrlo slične „nedostatke“, izuzev što je kod odustalih učenika više izražena percipirana slika o svom zdravlju u odnosu na *stalno aktivne* učenike.

Imajući u vidu sve dobrobiti kojima organizirano i stručno vođeno vježbanje doprinosi adolescentima, opravdano je težiti tome da što više adolescenata bude kineziološki aktivno tijekom razdoblja srednje, ali i kasne adolescencije. Ustanove koje provode organizirane kineziološke aktivnosti (škole te sportski i plesni klubovi) uz potporu lokalnih zajednica (općina, gradova i županija) bi trebale pokušati ostvarivati programe vježbanja koji omogućuju manje „oštru“ selekciju kako bi se adolescenti duže zadržali kineziološki aktivnima. Također, unutar klubova i sportskih zajednica bi trebalo raditi dopunske edukacije trenera u cilju njihova poticanja na stvaranje motivacijske klime pretežno *orijentirane na zadatak*, a manje na *izvanjsku evaluaciju* i na ostvarivanje *sportskih postignuća*. Orijentacija na zadatak uključuje i razvoj *zajedništva* među adolescentima koje općenito doprinosi boljoj socijalizaciji mladih (zadovoljstvo u bavljenju sportom i u sudjelovanju), ali kao neizravnu posljedicu ima i višu razinu želje adolescenata za ostajanjem u tom društvenom okruženju (sportskom, plesnom ili školskom klubu) te time i daljnjim bavljenjem organiziranim kineziološkim aktivnostima.

ZAKLJUČAK

U ovom su istraživanju utvrđene razlike u učestalosti pojavnosti odustajanja od bavljenja organiziranom kineziološkom aktivnošću pri čemu učenice u završnim razredima osnovne škole puno češće odustaju u odnosu na učenike. Analizom skupina *odustalih* i skupina *trajno aktivnih* po spolu ispitanika su utvrđene razlike slične onima koje se utvrđuju za opće uzorke adolescenta. Analizom skupina *odustalih* i *trajno aktivnih* u uzorku ispitanika istog spola utvrđena su obilježja *odustalih*. Njih karakteriziraju niža intrinzična motivacija,

niže kineziološka angažiranost i percipirana sportska kompetencija. Umjesto da se posvećuju samo ostvarenju sportskih postignuća ili pak samo evaluaciji mogućnosti adolescenata, nastavnici tjelesne zdravstvene kulture i treneri u sportskim klubovima trebaju stvarati u svojim radnim okružjima motivacijsku klimu *orijentiranu na zadatak* uz istodobno razvijanje osjećaja pune *sportske kompetentnosti* u svakog adolescenta. Nalazi ovog istraživanja ukazuju na potrebu daljnjeg istraživanja obilježja adolescenata koji odustaju od bavljenja organiziranim kineziološkim aktivnostima te istraživanja njihove učestalosti u odnosu na one koje ustraju, a u cilju ostvarivanja dugotrajnijeg bavljenja organiziranim i stručno vođenim kineziološkim aktivnostima adolescenata.

LITERATURA

Biddle, S.J.H., Gorely, T., & Stensel, D.J. (2004). Health-enhancing physical activity and sedentary behaviour in children and adolescents. *Journal of Sports Sciences*, 22(8), 679-701.

Chi, L., & Duda J.L. (1995). Multi-Sample Confirmatory Factor Analysis of the Task and Ego Orientation in Sport Questionnaire. *Research Quarterly for Exercise and Sport*, 66(2), 91-98.

Grgantov, Z., Milić, M., & Milavić, B. (2013). Relations between sports motivation in physical education classes and dropping out of organized kinesiological engagement in adolescence. In D. Madić (Ed.), *Proceedings of 3rd International Scientific Conference "Exercise and Quality of Life"* (pp. 285-290). Novi Sad: Faculty of Sport and Physical Education, University of Novi Sad.

Kautiainen, S., Koivusilta, L., Lintonen, T., Virtanen, S.M., & Rimpela, A. (2005). Use of information and communication technology and prevalence of overweight and obesity among finnish adolescent. *International journal of obesity*, 29(8), 925-933.

Lacković-Grgin, K. (1994). *Samopoimanje mladih*. Jastrebarsko: Naklada „Slap“.

Lindwall, M., & Lindgren, E.C. (2005). The effects of a 6-month exercise intervention programme on physical self-perceptions and social physique anxiety in non-physically active adolescent Swedish girls. *Psychology of Sport and Exercise*, 6(6), 643-658.

Milavić, B., Guć, D., & Miletić, Đ. (2010). The Relations Between Types of Motivation in Sport and Perceived Sport Competence. *FACTA Univesitatis: Physical Education and Sport*, 8(1), 59-69.

Milavić, B., Milić, M., Grgantov, Z., Elezović, J., Đapić-Caput, P., & Sinovčić, P. (2012). Relacije između kineziološke angažiranosti, psiholoških obilježja i tipova korištenja računala. U Đ. Miletić, S. Krstulović, Z. Grgantov, T. Bavčević, & A. Kezić (Ur.), *Proceedings book of 4th International scientific conference „Contemporary kinesiology“*, (str. 696-704). Split: Kineziološki fakultet Sveučilišta u Splitu.

Milić, M., Milavić, B., & Grgantov, Z. (2011). Relacije između zaokupljenosti sportom, samopoimanja, motivacije za sport i tipova korištenja računala adolescenata. In: Simović S. (Ed.) *Book of Summaries of 3rd International Scientific Conference „Anthropological Aspects of Sport, Physical Education and Recreation“* (pp. 43). Banja Luka: Faculty of Physical Education and Sport, University of Banja Luka.

Milić, M., Milavić, B., & Grgantov, Z. (2014). Relations between kinesiological engagement, psychological characteristics and types of mobile phone and computer usage in adolescents. *Facta universitatis, Series: Physical Education and Sport*, 12(2), 191-201.

Pezelj, L., Milavić, B., Gamulin, T., Sinovčić, P., & Šesnić, Z. (2015). Relacije između kineziološke angažiranosti, psiholoških obilježja i tipova korištenja televizije adolescenata. *Proceedings book of 5th International Scientific Conference „Contemporary Kinesiology“* (accepted, in press). Split: Faculty of Kinesiology, University of Split.

Samardžić, M., Bego, J., & Milavić, B. (2011). Psihološke razlike adolescenata ustrajnih u sportu i onih koji su odustali od organiziranog bavljenja sportom. In: Skender N., & Čikeš, N. (Eds.) *Proceedings of 2nd International Symposium “ Sport, Tourism and Health”*. Bihać. Bosnia and Herzegovina.

Research review of relation of visual-motor integration, motor abilities and ontogenetic development

Tonči Bavčević

Faculty of Kinesiology, University of Split, Croatia

ABSTRACT

The previous researches in the field of visual-motor integration are included in this paper. Along with the general considerations of the mentioned term there are also researches related to visual-motor integration as well as those related to development of fine motor skills and gross motor skills. There is also a review of scientific directions in the domain of ontogenetic development and of processes of visual-motor integration.

Key words: fine motor skills, gross motor skills, visual-motor abilities, growth and development of a child

INTRODUCTORY CONSIDERATIONS

Visual-motor integration represents a process of neuro-muscular synchronization that is of coordination of information from visual receptors and muscular effectors with the aim of realisation of precise motor activities. Most frequently the term visual-motor integration refers to coordination of eyes and hand that is fist muscles which enables precise manual activities. This complex process includes at the same time visual perception, as well as coordination of eye and hand (Beery, 1989).

Process of visual-motor integration results in development of fine motor skills necessary for normal function of human being, so as such it is carefully observed as a apart of ontogenetic development of a child. Coordination of visual receptors and fist motor function starts at the age of seven months of

intrauterine development when a child starts to see, and develops intensively in the early childhood, at the preschool age and younger school age. Visual-motor skills require abilities of turning visual perception into motor function, and they include motor control, motor precision, motor coordination and psycho-motor velocity (Sanghavi & Kelkar, 2005).

Process of visual-motor integration clearly reflects dynamics of growth and development of a child, and is used as such as a valid factor of neuro-motor development. Numerous researches imply significance of visual-motor integration in the process of education of a child. Compatibility of visual perception and hand motor function is crucial for adopting the writing skill (Beery, 1982; Kaiser, Albaret & Doudin, 2009; Matti-zassi, 1998; Weil & Amundson, 1994). Visual-motor integration proved to be important for success of children in other areas as well, such as reading, mathematics abilities, as well as the general success at school (Oliver, 1990; Maeland, 1992; Goldstein & Britt, 1994; Taylor, 1999).

Researches also imply that deficit in the process of visual-motor integration in children results in learning difficulties. Since the mentioned problems are closely related to the processes of integration of nervous system, falling behind in the field of visual-motor integration may imply problems in neurological development of a child (Thomas & Hacker, 1987). Difficulties in the process of visual-motor integration in children most frequently result in weaker grapho-motor abilities such as drawing geometric shapes, cutting with scissors, copying graphicsymbols, colouringand others (Darcy, 2001; Mattson, 1986). Improvement of developmental deficit in the field of visual-motor integration is possible by applying therapeutic procedures such as occupational sensorimotor therapy, which effects are seen from improvement of fine motor skills, especially of grapho-motor function (Oliver, 1990; Sanghavi & Kelkar, 2005).

VISUAL-MOTOR INTEGRATION AND FINE MOTOR SKILLS

Process of visual-motor integration is closely related to the development of fine motor skills. In order to perform a precise motor operation, especially in the initial phases of learning, it is necessary to coordinate information we receive from visual receptors and proprioception mechanisms which are activated on the level of muscle effectors.

The mentioned process is best seen from development of fine motor skills of a fist. Studies from the field of educational sciences are most frequently

oriented to testing development of grapho-motor skills that is ability of a child to write graphic symbols by using fine movements. Since grapho-motor skills are crucial on all educational levels and they influence academic achievement in a wide sense of different fields, the interest for scientific studying of this aspect of child development is logic.

Previous researches clearly show the relation of visual-motor integration and grapho-motor abilities. Researches in this field firstly have focus on the skill of writing that is of the quality of handwriting as a manifestation of grapho-motor abilities. Predictive value of visual-motor integration in relation to ability of writing is confirmed in numerous studies (Cornhill & Case-Smith, 1996; Maki, Voeten, Vauras, & Poskiparta, 2001; Weintraub & Graham, 2000). Tseng and Chow (2000) test differences between children considering the velocity of writing. Obtained results confirmed that visual-motor integration represents a significant differentiating factor between groups of subjects with normal and low writing velocity. It is accordingly established that visual-motor integration appears as a significant predictive factor of writing velocity in children with poorer results. Based on the results the authors conclude that children with slow writing velocity rely more on visual-motor integration. Weil and Amundson (1994) analyse relation of visual-motor integration and grapho-motor abilities on a sample of children between 5 and 7 years of age. Results clearly confirm the relation between the level of visual-motor integration and ability of legible copying of letters. In other words, better test results of visual-motor integration were followed by a disproportional increase of grapho-motor abilities. Research did not show and differences between girls and boys of preschool age in both fields, the field of visual-motor integration or in the field of grapho-motor abilities.

A certain number of studies did not confirm any significant relation between visual-motor integration and grapho-motor abilities. Marr and Cermak (2002) dismiss the hypothesis on predictive value of visual-motor integration in relation to low quality level of handwriting in first graders. As in the previous research, the results of Goyen and Duff (2005) show low sensitivity of VMI test (Beery, 2004) on the level of 34% in identifying poor handwriting quality. It is important to emphasise that these two presented studies had different methodological approach. The Marr and Cermak research included prediction of handwriting quality in time that is after a year, while the Goyen and Duff study was based on test results applied in the same period.

VISUAL-MOTOR INTEGRATION AND GROSS MOTOR SKILLS

In the field of studying neuro-motor development of a human being there is an important question which refers to the relation of the process of visual-motor integration and level of motor skills. Since motor efficiency depends on function of neuro-muscular system, it is possible to assume that there are positive relations between fine motor skills and gross motor skills. Still, due to a significant difference in realisation, by using the methods of learning and exercising, in practice the mentioned skills are frequently considered entirely in separate ways.

Bonifacci (2005) tests relations of visual-motor integration, gross motor skills and perceptual abilities on a sample of 144 primary school students at the age between 6 and 10. The study confirmed a significant difference in the level of visual-motor integration between children with high and low gross motor skills. Difference on the level of perceptual skills and intellectual abilities was not registered.

A great number of researches regarding motor development of children imply a conclusion that the processes of development of fine motor skills and gross motor skills develop separately. Accordingly, in some cases results imply higher degree of development of fine motor skills, while in other cases a higher level of gross motor skills was registered (De Barros, Fragoso, de Oliveira, Cabral Filho & de Castro, 2003; Rezende, Beteli & dos Santos, 2005).

Darrah et al. (2003) conduct a longitudinal study on children aged 9 to 21 months, whilst analysing the achievements of children in fine motor skills and gross motor skills. The authors carry out their conclusion according to which the observed motor dimensions are realised separately, opposite to assumption of intra-individual stability. Results of the study conducted by Darrah, Senthilselvan and Magill-Evans (2009) also advocate the hypothesis that the development of fine motor skills and gross motor skills is characterised by intra-individual variability and fluctuation in their rate of growth.

Generally, most scientific studies show that the course of growth and development of children is characterised by a significant variability in dynamics, where the phases of fast and slow growth of some features and abilities alternate, which results in significant intra-individual and inter-individual differences (Darrah, Redfern, Maguire, Beaulne & Watt, 1998; Rosenbaum, 2006; Souza et al., 2010).

ONTOGENETIC DEVELOPMENT AND VISUAL-MOTOR INTEGRATION

Studying visual-motor integration as a part of ontogenetic development of a child represents a quite significant scientific question. Numerous studies dealt with testing relation of visual-motor integration with the process of growth and development in different life stages.

Decker (2008) carried out a study with the aim of establishing developmental changes in visual-motor abilities during human life. Research results show that visual-motor abilities grow fast till the period of middle adolescence, they weaken through the period of maturity and they rapidly decrease in the late years of life. Obtained results are contradictory to the statements which suggest that visual-motor development ends in late childhood and remains constant during life period.

Decker, Englund, Carboni and Brooks (2011) study influence of maturing and cognitive abilities on visual-motor integration in 4 to 7 years old children. Study results confirm that maturing and intelligence significantly influence the process of visual-motor integration. Accordingly the results especially point to contribution on non-verbal reasoning and visual-spatial attention of a child as a significant factor of visual-motor integration.

Lin, Luo, Wu, Shen and Sun (2015) conduct a study with the aim of establishing dynamics of fine motor development in children aged 6 to 12. As part of the research they analysed drawing trajectories as well as kinetic and kinematic parameters. Drawing straight lines and drawing circles were performed on a force sensitive tablet. Three determined spatial parameters were cumulative trace length, vector length of a straight line and vertical diameter of a circle. Drawing duration, mean drawing velocity and number of peaks in stroke velocity profile (NPV) were used as kinematic parameters. Besides mean normal force, two other kinetic parameters were used and those are normalized force angle regulation (NFR) and variation of fine motor control (VFC) for circles drawing task. Obtained results show that maturation and automation of fine motor abilities reflect on increased drawing velocity, reduced drawing duration, NPV and NFR, and on decreased VFC in circles drawing task. The main growth and task effect, as well as significant correlations between age and observed parameters suggest that during estimation of fine motor skills it is important to take into consideration factors such as education, age and types of tasks. In comparison to kinematic parameters, values of NFR and VFC imply a conclusion that kinetic parameters are also an important factor in analysis of fine motor movements.

Flatters, Hill, Williams, Barber and Mon-Williams (2014) test differences between girls and boys in development of manual skills. Grapho-motor skills were estimated by the use of tablet and the subjects were asked to use stylus to make (a) a series of aiming movements, (b) trace a series of abstract shapes and (c) trace a moving object. The tasks were not familiar to the children allowing measurement of general abilities defined as manual control without influence of cultural and experience differences. Obtained results showed a significant influence of sex and age in aiming task, with girls being faster in task realisation in younger age group (aged 4 to 5), and boys in older age group (aged 10 to 11). These results are consistent to the previous knowledge which implies better results in boys macro-motor aiming tasks which start in the period of adolescence. Small, but significant difference was registered in tracing skill test where girls gave better results considering age. There were no differences between the groups of subjects considering the tracing task test. In general, results suggest that prepubescent girls are more likely to have better manual control abilities for performing new tasks. Still, based on the conducted research, it is not possible to suggest that girls and boys require different approach in the development of manual skills through education.

CONCLUSION

Researches of visual-motor integration show a significant degree of relation between neurological and motor development of a human being in the domain of fine motor skills as well as in the domain of gross motor skills. Also, study results show that the process of visual-motor integration follows ontogenetic dynamics from the aspect of age and from the aspect of differences between the genders. All the mentioned implies the importance of studying the mentioned phenomenon within the aim of comprehensive understanding of motor development of a human being.

REFERENCES

- Beery, K. E. (1982). *Revised administration, scoring and teaching manual for the Developmental Test of Visual-Motor Integration*. Cleveland: Modern Curriculum Press.
- Beery, K. E. (1989). *The Developmental Test of Visual-Motor Integration* (3rd. ed.). Cleveland: Modern Curriculum Press.

Beery, K. E. (2004). *The Beery-Buktenica developmental test of visual-motor integration* (5th ed.). Minneapolis, MN: NCS Pearson, Inc.

Bonifacci, P. (2004). Children with low motor ability have lower visual-motor integration ability but unaffected perceptual skills. *Human Movement Science*, 23 (2), 157-68.

Cornhill, H., & Case-Smith, J. (1996). Factors that relate good and poor handwriting. *The American Journal of Occupational Therapy*, 50 (9), 732-739.

Darcy, A. U. (2001). *Neurological rehabilitation* (4th ed.). St Louis: C. V. Mosby Company.

Darrah, J., Hodge, M., Magill-Evans, J., & Kembhavi, G. (2003). Stability of serial assessments of motor and communication abilities in typically developing infants-implications for screening. *Early Hum Dev.*, 72 (2), 97-110.

Darrah, J., Redfern, L., Maguire, T. O., Beaulne, A. P., & Watt, J. (1998). Intra-individual stability of rate of gross motor development in full-term infants. *Early Hum Dev.*, 52 (2), 169-79.

Darrah, J., Senthilselvan, A., & Magill-Evans J. (2009). Trajectories of serial motor scores of typically developing children: Implications for clinical decision making. *Infant Behav Dev.*, 32 (1), 72-8.

De Barros, K. M., Fragoso, A. G., de Oliveira, A. L., Cabral Filho, J. E., & de Castro, R. M. (2003). Do environmental influences alter motor abilities acquisition? A comparison among children from day-care centers and private schools. *Arq Neuropsiquiatr*, 61 (2A), 170-175.

Decker, S. L. (2008). Measuring growth and decline in visual-motor processes with the Bender-Gestalt second edition. *Journal of Psychoeducational Assessment*, 26 (1), 3-15.

Decker, S. L., Englund, J. A., Carboni, J. A., & Brooks, J. H. (2011). Cognitive and Developmental Influences in Visual-Motor Integration Skills in Young Children. *Psychological Assessment*, 23 (4), 1010-1016.

Flatters, I., Hill, L. J. B., Williams, J. H. G., Barber, S. E., & Mon-Williams, M. (2014). Manual Control Age and Sex Differences in 4 to 11 Year Old Children. *Plos One*, 9 (2).

Goldstein, D. J., & Britt, T. W. (1994). Visual-motor co-ordination and Intelligence as predictors of reading, mathematics and writing language ability. *Perceptual and motor skills*, 78, 819-823.

Goyen, T.-A., & Duff, S. (2005). Discriminant validity of the developmental test of visual-motor integration in relation to children with handwriting dysfunction. *Australian Occupational Therapy Journal*, 52, 109-115.

Kaiser, M. L., Albaret, J. M., & Doudin, P. A. (2009). Relationship Between Visual-Motor Integration, Eye-Hand Coordination, and Quality of Handwriting. *Journal of Occupational Therapy, Schools, & Early Intervention*, 2, 87-95.

Lin, Q. S., Luo, J. F., Wu, Z. C., Shen, F., & Sun, Z. W. (2015). Characterization of fine motor development: Dynamic analysis of children's drawing movements. *Human Movement Science*, 40, 163-175.

Maeland, A. E. (1992). Handwriting and perceptual-motor skills in clumsy, dysgraphic and normal children. *Perceptual and Motor skills*, 75, 1207-1217.

Maki, H. S., Voeten, M. J. M., Vauras, M. M. S., & Poskiparta, E. H. (2001). Predicting writing skill development with word recognition and preschool readiness skills. *Reading and Writing: An Interdisciplinary Journal*, 14 (7-8), 643-672.

Marr, D., & Cermak, S. A. (2002). Predicting handwriting performance of early elementary students with the developmental test of visual-motor integration. *Perceptual and Motor Skills*, 95, 661-669.

Mati-zassi, H. (1998). Drawing performance in children with learning difficulties. *Perceptual and Motor skills*, 87 (2), 487-497.

Mattson, R. E. (1986). An analysis of visual-motor problems in learning disabled children. *Bulletin of the Psychonomic society*, 24 (1), 51-54.

Oliver, C. E. (1990). A Sensorimotor program for improving writing readiness skills in Elementary-Age Children. *The American journal of occupational therapy*, 44, 111-116.

Rezende, M. A., Beteli, V. C., & dos Santos, J. L. (2005). Follow-up of the child's motor abilities in day-care centers and pre-schools. *Rev Lat Am Enfermagem*, 13 (5). 619-625.

Rosenbaum, P. (2006). Classification of abnormal neurological outcome. *Early Hum Dev.*, 82 (3), 167-71.

Sanghavi, R., & Kelkar, R. (2005). Visual-motor integration and learning disabled children. *The Indian Journal of Occupational Therapy*, 37 (2), 33-38.

Souza, C. T., Santos, D. C. C., Tolocka, R. E., Baltieri, L., Gibim, N. C., & Habechian, F. A. P. (2010). Assessment of global motor performance and gross and fine motor skills of infants attending day care centers. *Brazilian Journal of Physical Therapy*, 14 (4).

Taylor, K. P. (1999). Relationship between visual motor integration skill and academic performance in kindergarten through third grade. *Optometry and vision science: official publication of the American Academy of Optometry*, 76 (3), 159-163.

Thomas, L. K., & Hacker, B. J. (1987). *A Therapist's guide to paediatric assessment*. Boston: Little Brown & Company.

Tseng, M. H., & Chow, S. M. K. (2000). Perceptual-motor function of school-age children with slow handwriting speed. *American Journal of Occupational Therapy*, 54 (1), 83-88.

Weil, M. J., & Amundson, S. J. C. (1994). Relationship between visuomotor and handwriting skills of children in kindergarten. *American Journal of Occupational Therapy*, 48 (11), 982-988.

Weintraub, N., & Graham, S. (2000). The contribution of gender, orthographic, finger function, and visual-motor processes to the prediction of handwriting status. *The Occupational Therapy Journal of Research*, 20 (2), 121-140.

Ambidekstrijia kao mogući prediktor uspješnosti u ritmičkoj gimnastici kod studenata

Ana Kezić, Nina Ivančić, Mia Mandić

Kineziološki fakultet, Sveučilište u Splitu, Hrvatska

ABSTRACT

The main aim of this paper was to determine the influence of ambidexterity with apparatus on rope composition performance in kinesiology students. The participants were 55 kinesiology students (37 male and 18 female), all involved in Rhythmic gymnastics classes for 15 weeks. They performed 3 elements with apparatus with their dominant and non-dominant body side (arm), as well as rope composition which was evaluated by previously prescribed procedure. Coefficients of asymmetry of the 3 elements were calculated. ANOVA showed differences only in rope composition performance between the genders, while no differences were found in ambidexterity elements. Also, no significant influence of ambidexterity elements on rope composition performance was found in either gender. Results partially confirm previous reserach and suggest better programing of the educational process. To gain more serious conclusions on ambidexterity in rhythmic gymnastics, competitive subjects must be involved.

Key words: ambidexterity, asymmetry, composition, students, gender

UVOD

Ono što ritmičku gimnastiku kao sport čini jedinstvenim jest ovladavanje dvama motoričkim zadacima u isto vrijeme: tehnike tijelom i tehnike spravom (Jastrjemskaia i Titov, 1999). Da bi se ove tehnike usavršile na što većoj razini ključno je pratiti napredak i bilježiti ga tijekom vremena. Ovo je osobito važno u natjecateljskoj ritmičkoj gimnastici, međutim, isto tako, nije zanemarivo u edukacijskom procesu ovog sporta kako bi se takav proces što kvalitetnije

organizirao i doveo do zadovoljavajućih rezultata. Tehnička izvedba (bilo tijelom, bilo spravom) može se mjeriti na više načina, a jedan od načina je i praćenje razine ambidekstrije. Ambidekstrija je sposobnost pojedinca da jednako dobro koristi obje strane tijela (ruke, noge). U ritmičkoj gimnastici moguće ju je izraziti kroz koeficijent asimetrije, a kojeg je moguće izračunati omjerom kvalitete izvođenja dominantne i nedominantne strane tijela (ruke, noge). Ovaj aspekt tehnike u ritmičkoj gimnastici smatra se vrlo važnim za uspjeh s obzirom da su istraživanja pokazala kako potrebna razina ambideksternosti iznosi 41% za određene rekvizite (Jastrjemskaia i Titov, 1999).

Prethodna istraživanja na istom uzorku (Božanić i Miletić, 2011) uključivala su koeficijente asimetrije elemenata tijelom (skokova, okreta, ravnoteža i pokretljivosti) i pokazala su kako isti značajno utječu na izvođenje kompozicija samo kod muškog uzorka studenata, dok kod studentica nije bilo značajnih prediktora. Međutim, u spomenutom istraživanju uzeti su u obzir samo koeficijenti asimetrije elemenata tijelom, dok elementi spravama nisu bili uključeni. Kako se uspjeh ispitanika u ritmičkoj gimnastici mjeri isključivo izvedbom kompozicija s rekvizitima potrebno je utvrditi i zavisnost mjera asimetrije elemenata spravama s izvedbom kompozicije. Ovakva saznanja pomogla bi pri organizaciji edukacijskog procesa jer bi pružila informacije o potrebitosti uvježbavanja nedominantne strane tijela (ruke, noge).

Cilj ovog istraživanja bio je utvrditi utjecaj koeficijenata asimetrije elemenata spravama na izvođenje kompozicije vijačom kod studenata i studentica kineziologije.

METODE RADA

Uzorak ispitanika za potrebe ovog istraživanja sačinjavao je 55 studenata (37 studenata i 18 studentica) Kineziološkog fakulteta. Kronološka dob ispitanika, inače studenata 2 godine preddiplomskog studija bila je 20.9 godina (\pm 1.6 godina). Svi su sudjelovali u nastavi Ritmičke gimnastike kroz cijeli semestar, 15 tjedana po 3 sata tjedno. Svi ispitanici slušali su isti program pod vodstvom istog nastavnika. Kako su svi ispitanici bili početnici, najprije su prošli učenje tehnika tijelom (5 tjedana), a zatim i 9 tjedana tehnika spravama. Zadnji tjedan izvršena su testiranja ambidekstrije i kompozicije vijačom.

Ambidekstrijom nazivamo sposobnost osobe da jednako dobro koristi obje strane tijela (obje ruke/obje noge). U ritmičkoj gimnastici ambidekstrija se izražava kroz koeficijent asimetrije. Za potrebe istraživanja kod ispitanika su testirani slijedeći elementi koje su oni izvodili s dominantnom i nedominantnom stranom tijela (u ovom slučaju rukom): (1) osmica loptom (AMBLOP); (2) spirala

i 'eschappe' trakom (AMBTRA); i (3) vaga i 'kuhanje' vijačom (AMBVIJ). Ispitanici su element izvodili tri puta i u obzir je uzeta samo najbolja ocjena. Ocjenjivanje je izvršila predmetna nastavnica s višegodišnjim iskustvom u suđenju ritmičke gimnastike na Likertovoj skali od 1 do 5. Evaluirana je izvedba dominantnom i nedominantnom rukom za svaki element i te ocjene unesene su u formulu (Jastrjemskaia i Titov, 1999):

$$KA = D - ND / D$$

gdje je KA = koeficijent asimetrije, D = dominantna strana (ruka), i ND = nedominantna strana (ruka).

Testiranje izvedbe kompozicije vijačom provedeno je na način da je svaki ispitanik pojedinačno izvodio kompoziciju tri puta, a u obzir je uzet najbolji rezultat. Ispitanici su kompoziciju uvježbavali četiri tjedna i svi su imali podjednako vrijeme za uvježbavanje. Ocjenjivanje je izvršeno po već validiranoj proceduri (Božanić i Miletić, 2011) od strane iste predmetne nastavnice i to na način da se svaki od 14 dijelova kompozicije zasebno ocjenjivao ocjenama 0, 1 i 2, ovisno da li je element izveden, nije izveden, ili je izveden djelomično. Tako je najveći mogući zbroj bodova za izvedbu mogao biti 28.

Prikazani su slijedeći deskriptivni statistički parametri: aritmetička sredina (AS), standardna devijacija (SD), minimalne (MIN) i maksimalne (MAX) vrijednosti rezultata. Razlike između spolova u istim varijablama testirane su analizom varijance (F, p). Utjecaj mjera ambidekstrije na samu izvedbu kompozicije vijačom testirana je multiplom regresijskom analizom (R, p).

REZULTATI I RASPRAVA

TABLICA 1. Deskriptivna statistika varijabli ambidekstrije i kompozicije vijačom po spolu te analiza varijance za utvrđivanje razlika među spolovima

	STUDENTI (N=37)				STUDENTICE (N=18)				ANOVA	
	AS	SD	MIN	MAX	AS	SD	MIN	MAX	F	p
KOMVIJ	19.27	3.77	10.00	25.00	22.61	3.43	14.00	28.00	10.07	0.00
AMBLOP	0.09	0.14	0.00	0.50	0.08	0.11	0.00	0.25	0.10	0.75
ABMVIJ	0.18	0.15	0.00	0.50	0.12	0.13	0.00	0.33	2.08	0.15
AMBTRA	0.13	0.16	0.00	0.50	0.10	0.13	0.00	0.40	0.75	0.39

Legenda: KOMVIJ – kompozicija vijačom, AMBLOP – ambidekstrija loptom, AMBVIJ – ambidekstrija vijačom, AMBTRA – ambidekstrija trakom.

Deskriptivni parametri zasebno po spolu pokazuju kako su i studenti i studentice najujednačeniji u tehnikama loptom, što je i očekivano obzirom

da su jedino s tim rekvizitom bili upoznati prije početka nastave ritmičke gimnastike. Razlika između lijeve i desne strane tijela najviše se očitovala prilikom vježbanja vijačom (element "kuhanja") i kod studenata i kod studentica. Dakle, prema testu ANOVA, statistički značajne razlike između spolova u koeficijentu ambidekstrije u svim elementima nisu pronađene, što je bio slučaj i kod koeficijenata asimetrije elemenata tijelom u prethodnim istraživanjima (Božanić i Miletić, 2011). Međutim, razlika je pronađena u samoj izvedbi kompozicije vijačom ($p=0.00$) u korist studentica, što je potvrda i prethodnom istraživanju. Ovakvo saznanje moglo bi se potvrditi činjenicom kako osim tehničke preciznosti izvođenja, ritmička gimnastika zahtijeva i gracioznost i umjetničku prezentaciju (Jastrjemskaia i Titov, 1999) i nedostatak potonjeg kod muške populacije jedan je od razloga njihovih slabijih ocjena. Isto tako, poznato je kako su muškarci manje fleksibilni od žena (Haley, Tada & Carmichael, 1986; Jones, Buis & Harris, 1986; Gabbard & Tandy, 1988) i ta činjenica vjerojatno je pridonijela manjoj uspješnosti studenata u izvođenju tehničkih elemenata tijelom, pošto su amplituda i definirana forma strogo uvjetovani.

TABLICA 2. Rezultati regresijske analize zasebno za studente i studentice s kompozicijom vijačom kao prediktorom

	STUDENTI		STUDENTICE	
	Beta	p	Beta	p
AMBLOP	-0.35	0.03	-0.31	0.24
ABMVIJ	0.01	0.95	-0.10	0.67
AMBTRA	-0.10	0.52	-0.09	0.71
	Multiple R 0.36		Multiple R 0.32	
	p 0.17		p 0.65	

Legenda: AMBLOP – ambidekstrija loptom, ABMVIJ – ambidekstrija vijačom, AMBTRA – ambidekstrija trakom.

Rezultati regresijske analize otkrivaju kako skup prediktora (koeficijenti asimetrije elemenata spravama) ni u jednom uzorku značajno ne utječe na kriterij (kompoziciju vijačom). S obzirom da je prethodno istraživanje (Božanić i Miletić, 2011) pokazalo kako je ambidekstrija elemenata tijelom bila značajna samo kod muškog spola, ali ne i kod žena, ovakav rezultat dijelom je i očekivan. Ipak, s obzirom da se radi o kompoziciji u kojoj je radi rukovanja vijačom vidljivo zastupljena manipulacija obim rukama, nedostatak utjecaja ambidekstrije intrigira. Moguće je, stoga, utvrditi kako je za izvedbu ovakve kompleksne

strukture, pogotovo za mušku populaciju studenata, od ambidekstrije rekvizitima ipak važnija kvaliteta usvojenosti osnovnih elemenata tijelom s obe strane tijela i to pogotovo elemenata s izraženom fleksibilnošću, kako navode dosadašnja istraživanja (Božanić i Miletić, 2011). Takvo saznanje potrebno je integrirati i u plan i program i predvidjeti više sati uvježbavanja osnovnih elemenata tijelom, nauštrb uvježbavanja tehnike rekvizitima nedominantnom stranom tijela.

ZAKLJUČAK

Ambidekstrija u smislu jednako dobrog rukovanja rekvizitima obim stranama tijela nije se pokazala kao značajan prediktor za izvođenje kompozicije vijačom na populaciji studenata kineziologije. Ovakva saznanja daju smjernice za što učinkovitijim planiranjem edukacijskog procesa studenata.

Međutim, ovo nikako nije pretpostavka da je za uspjeh u natjecateljskoj ritmičkoj gimnastici ambidekstrija nepotrebna ili da je njeno uvježbavanje nesvrshodno. Važeći pravilnik ritmičke gimnastike nalaže jednaku upotrebu lijeve i desne ruke (noge) kroz cijelu natjecateljsku kompoziciju. Nedostatak istog kažnjava se negativnim bodovima. Dakle, ovakva istraživanja potrebno je provesti u natjecateljskoj sferi ovog sporta čime bismo došli do kvalitetnih kinezioloških spoznaja koje bi obogatile svaki trenažni proces.

LITERATURA

Božanić, A. i Miletić, Đ. (2011). Differences between the sexes in technical mastery of rhythmic gymnastics. *Journal of Sports Sciences*, 29(4), 337-343

Jastrjemskaia, N. i Titov, Y. (1999). *Rhythmic gymnastics*. USA: Human Kinetics.

Haley, S.M., Tada, W.L. & Carmichael, E.M. (1986). Spinal mobility in young children: a normative study. *Physical Therapy*, 66(11), 1697-1703.

Jones, M.A., Buis, J.M. & Harris, I.D. (1986). Relationship of race and sex to physical and motor measures. *Perceptual and Motor Skills*, 63(1), 169-170.

Gabbard, C. & Tandy, R. (1988). Body composition and flexibility among prepubescent males and females. *Journal of Human Movement Studies*, 14(4), 153-159.

Construction and validation of the test for evaluation of visual-motor integration in children aged 7 to 10

Tonči Bavčević, Damir Bavčević

Faculty of Kinesiology, University of Split, Croatia

ABSTRACT

Newly constructed test for evaluation of visual-motor integration in children aged 7 to 10 is presented in this paper. The test was applied on students from lower primary school grades with the aim of establishing metric characteristics and practical application of the test. The test evaluates micromotor efficiency of grapho-motor type as an integrative part of visual-motor integration and it is adequate for evaluation of development of children in preschool and in younger school age.

Key words: fine motor skills, grapho-motor skills, micromotor efficiency, measuring instrument, metric characteristics

INTRODUCTION

Visual-motor integration as ability of neuromuscular synchronisation of visual perception and of motor performance of fine movement is an extremely important part of integrative development of a child. Numerous studies indicate the importance of visual-motor integration in the process of growth and development (Decker, 2008; Decker, Englund, Carboni & Brooks, 2011; Lin, Luo, Wu, Shen & Sun, 2015). Visual-motor integration of grapho-motor type, which significantly determines dynamics of apprehending fine motor skills such as writing, is particularly important for success of a child in preschool and primary education (Cornhill & Case-Smith, 1996; Maki, Voeten, Vauras, & Poskiparta, 2001; Tseng & Chow, 2000; Weil & Amundson, 1994; Weintraub & Graham, 2000). Previous results suggest that micromotor efficiency, such as fist

control, is determined by the level of fine motor skills and specific fine motor abilities as well as the degree of visual-motor integration of related sensori-motor mechanisms (scheme 1).

Since visual-motor integration represents a significant ontogenetic process there is a need for following its development. The aim of this paper is to present results of construction and validation of the newly constructed test for estimation of visual-motor integration in children aged 7 to 10.

Scheme 1

Cybernetic model of micromotor efficiency.

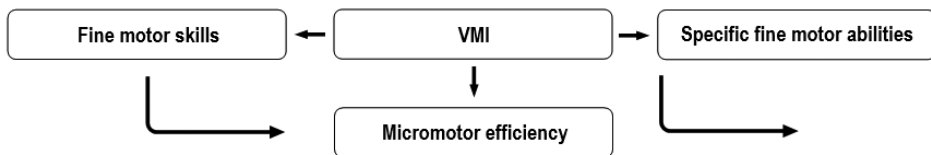

WORK METHODS

For the needs of this research the sample of subjects consisted of 163 students aged 7 to 10, out of which 92 boys and 71 girls. Evaluation was conducted on students from first to fourth grade from the primary school Meje in Split, Croatia, in May 2015. All subjects were clinically healthy without any registered disorders in growth and development. Structure of the sample is shown in details in table 1.

Table 1

Structure of the sample of subjects.

grade	male	female	total
1 st	30	19	49
2 nd	23	20	43
3 rd	20	18	38
4 th	19	14	33
total	92	71	163

Collecting data was conducted by using the newly constructed test for evaluating visual-motor integration (VMI). The test was constructed with the

aim of evaluating grapho-motor abilities as a special aspect of visual-motor development process.

Scheme 2

Graphic demonstration of the VMI test.

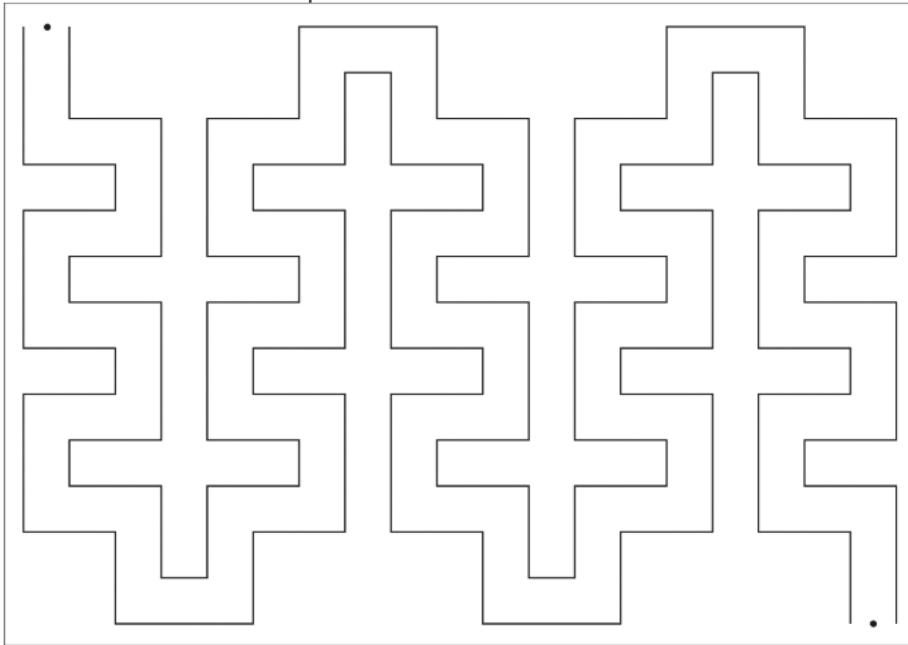

The visual-motor integration test (VMI) consists of two parallel broken lines with spacing of 1,5 cm between them, drawn on paper of A4 dimensions. Drawn lines form a path broken on the total of 59 segments. The spacing between the beginning dot and the final dot is 178,5 cm (Scheme 2).

Paper is put in front of a subject in a horizontal position. Task of the subject is to connect the beginning and the final dot as fast as possible by drawing a line with a pencil. The line should be drawn without interruption and without touching the outlines of the path. The line is drawn with the dominant hand with a pencil of B-2B type.

Evaluator tests time necessary for performing the task in seconds. After the task is done the number of errors is determined. An error is any interruption in line as well as touching the outlines of the path. Final result of the VMI test is a sum of time necessary for doing the task and of all errors multiplied by two. Formula for calculating test results is shown in scheme 3.

Scheme 3

Formula for calculating the VMI test results.

$$\text{VMI} = \text{VMI}_{\text{time}} + 2\text{VMI}_{\text{errors}}$$

The obtained results were used to calculate the following parameters of descriptive statistics: the mean, the minimum and maximum result, the standard deviation (SD), the skewness (α_3), the kurtosis (α_4).

Relation between time for doing the VMI test, number of errors and the final result of the VMI test was tested by application of correlation analysis, whilst the Pearson linear correlation coefficient (r) was calculated. Evaluating the significance of correlation coefficients was carried out by comparing the obtained coefficients with the values from the F table (Dizdar, 2006). With degree number of freedom ($df = n-2$) and standard error of estimate of 0,05 the lower critical coefficient for boys is 0,205 and for girls it is 0,232.

Testing the normal distribution of data was carried out by application of the Kolmogorov-Smirnov test (KS-test). This statistical procedure is based on comparison of empiric relative cumulative frequencies and theoretic relative cumulative frequencies. If the highest deviation between the empiric and theoretic relative cumulative frequency (max d) is lower than critical value of the KS-test ($\text{max } d < \text{KS-test}$), it is concluded that the empiric distribution does not deviate statistically significant from normal distribution with a particular error (Dizdar, 2006; Pauše, 1993). In the presented research the critical value of the KS-test is a possibility of an error on the level 0,05. Critical that is table values of the KS-test were taken from Dizdar (2006).

RESULTS

Parameters of descriptive statistics and the results of the Kolmogorov-Smirnov test of normal data distribution for the VMI test variables are shown in table 2.

Table 2

Parameters of descriptive statistics and the Kolmogorov-Smirnov test of normal data distribution for the VMI test results.

	gender	mean	min	max	SD	α_3	α_4	max d
VMI _{time}	male	25,33	12,93	63,71	8,67	1,81	4,62	0,178
	female	22,68	14,48	52,98	6,82	1,70	4,65	0,132
VMI _{errors}	male	3,65	0,00	11,00	2,73	0,90	0,27	0,181
	female	3,70	0,00	14,00	2,91	1,41	2,08	0,187
VMI	male	32,64	16,65	73,71	9,82	1,61	4,56	0,107
	female	30,09	16,73	58,98	7,72	0,86	1,50	0,113

Critical value max d ($p < 0,05$): male = 0,205; female = 0,232

By comparing of the means (mean) and the related standard deviations (SD) for variable VMI_{time} it is possible to notice that the average deviations are approximately 1/3 of the value mean in both subsamples, while in boys was registered slightly higher value of the average result deviation. The skewness value ($\alpha_3 = 1,81$; $\alpha_3 = 1,70$) implies the appearance of a slight positive skewness with result deviation in the zone of lower values in both boys and girls. By analysing the kurtosis ($\alpha_4 = 4,62$; $\alpha_4 = 4,65$) it is possible to notice significant leptocurticity which indicates grouping of the data in the zone of middle values in both subsamples of subjects.

Average number of errors in the analysed test is VMI_{errors} = 3,65 for boys and VMI_{errors} = 3,70 for girls with average deviation of SD = 2,73 that is SD = 2,91. The skewness and kurtosis values in subsample of boys ($\alpha_3 = 0,90$; $\alpha_4 = 0,27$) indicates normal data distribution without significant deviations from the reference values. In subsample of girls the skewness ($\alpha_3 = 1,41$) indicates appearance of a slight positive asymmetry that is movement in result to the zone of lower values. Also, in subsample of girls there was a higher kurtosis ($\alpha_4 = 2,08$) which indicates leptocurticity of the data distribution.

In subsample of boys total average VMI test results are VMI = 32,64 with average deviation SD = 9,82 and in girls that value is VMI = 30,09 with average deviation SD = 7,72. Registered standard deviations do not exceed 1/3 of the value of the related mean, which indicates homogeneity of achieved results in relation to the average value. Analysis of the skewness in subsample of boys ($\alpha_3 = 1,61$) indicates a slight positive distribution asymmetry, while the high

kurtosis ($\alpha_4 = 4,56$) indicates an expressed leptocurticity of the distribution curve that is an expressed data grouping around the average value. In subsample of girls the skewness ($\alpha_3 = 0,86$) confirms symmetry of distribution, and a slightly higher kurtosis ($\alpha_4 = 1,50$) indicates a very mild leptocurticity of the distribution curve.

Results of the Kolmogorov-Smirnov test show in all three variables that maximum deviations between empiric and theoretic relative cumulative frequencies (max d) do not cross critical value of the KS-test neither in boys or girls. According to the mentioned, it can be concluded that values of the variables VMI_{time} , VMI_{errors} and VMI have normal distribution. Results of normal testing are also graphically shown on histograms 1 and 2.

Histogram 1

Graphic demonstration of data distribution for subsample of boys.

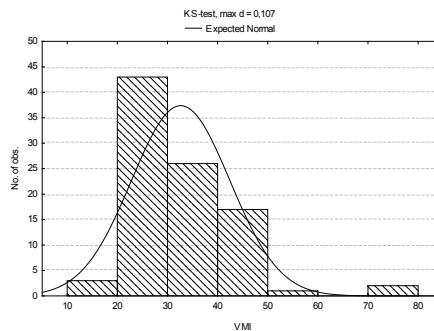

Histogram 2

Graphic demonstration of data distribution for subsample of girls.

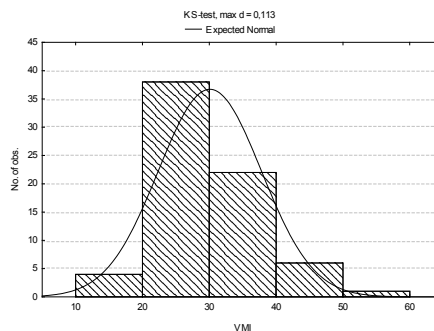

Matrix of correlations between the VMI test parameters are shown in table 3. Analysis of the results of correlation analysis in subsample of boys indicates a strong positive correlative relation between variables VMI and VMI_{time} ($r = 0,83$) as well as weak positive, but significant relation between variables VMI i VMI_{errors} (0,48). Similar results were obtained from subsample of girls in which statistically significant middle strong correlation was registered also between variables VMI and VMI_{time} ($r = 0,69$) and variables VMI and VMI_{errors} ($r = 0,52$). Obtained results were expected since the final result of the VMI test was obtained by summing values of variable VMI_{time} and variable VMI_{errors} multiplied by two. In girls, along with the mentioned results, was also registered a statistically significant weak negative correlation between variables VMI_{time} and VMI_{errors} ($r = -0,26$), which implies a conclusion that girls who did the test faster also made more errors.

Table 3
Matrix of correlations of the VMI test parameters.

	male			female		
	VMI _{time}	VMI _{errors}	VMI	VMI _{time}	VMI _{errors}	VMI
VMI _{time}	1,00			1,00		
VMI _{errors}	-0,09	1,00		-0,26*	1,00	
VMI	0,83*	0,48*	1,00	0,69*	0,52*	1,00

*statistically significant correlations

DISCUSSION AND CONCLUSION

Based on the obtained results it can be concluded that analysed metric characteristics of the newly constructed test for evaluation of visual-motor integration satisfy methodological demands of sensitivity and reliability. Measuring instrument distinguishes well subjects of both genders, with clearly defined normal data distribution. Method of calculating the final VMI test result by adding time necessary for solving the test and number of errors multiplied by two appeared reliable, since it results in additional normalising of data distribution.

It is particularly possible to emphasise the simplicity of protocol while applying the VMI test which enables fast, simple and effective testing of a great

number of subjects. Conducted analysis confirms that the test is appropriate for students of younger school age, that is to children aged 7 to 10, but it can also be applied in children of preschool age.

Considering the importance of visual-motor integration in ontogenetic development of a child and the need for following it, it can be concluded that the newly constructed VMI test represents a valuable measuring instrument which can be well used in research as well as in education.

REFERENCES

Cornhill, H., & Case-Smith, J. (1996). Factors that relate good and poor handwriting. *The American Journal of Occupational Therapy*, 50 (9), 732-739.

Decker, S. L. (2008). Measuring growth and decline in visual-motor processes with the Bender-Gestalt second edition. *Journal of Psychoeducational Assessment*, 26 (1), 3-15.

Decker, S. L., Englund, J. A., Carboni, J. A., & Brooks, J. H. (2011). Cognitive and Developmental Influences in Visual-Motor Integration Skills in Young Children. *Psychological Assessment*, 23 (4), 1010-1016.

Dizdar, D. (2006). *Kvantitativne metode*. Zagreb: Kineziološki fakultet Sveučilišta u Zagrebu.

Lin, Q. S., Luo, J. F., Wu, Z. C., Shen, F., & Sun, Z. W. (2015). Characterization of fine motor development: Dynamic analysis of children's drawing movements. *Human Movement Science*, 40, 163-175.

Maki, H. S., Voeten, M. J. M., Vauras, M. M. S., & Poskiparta, E. H. (2001). Predicting writing skill development with word recognition and preschool readiness skills. *Reading and Writing: An Interdisciplinary Journal*, 14 (7-8), 643-672.

Pauše, Ž. (1993). *Uvod u matematičku statistiku*. Zagreb: Školska knjiga.

Tseng, M. H., & Chow, S. M. K. (2000). Perceptual-motor function of school-age children with slow handwriting speed. *American Journal of Occupational Therapy*, 54 (1), 83-88.

Weil, M. J., & Amundson, S. J. C. (1994). Relationship between visuomotor and handwriting skills of children in kindergarten. *American Journal of Occupational Therapy*, 48 (11), 982-988.

Weintraub, N., & Graham, S. (2000). The contribution of gender, orthographic, finger function, and visual-motor processes to the prediction of handwriting status. *The Occupational Therapy Journal of Research*, 20 (2), 121-140.

Preliminary research results of visual-motor integration in children aged 7 to 10

Teo Bavčević, Tonči Bavčević, Damir Bavčević

Faculty of Kinesiology, University of Split, Croatia

ABSTRACT

This paper is a part of research on visual-motor integration in children aged 7 to 10. It contains preliminary results obtained by the application on the newly constructed test of visual-motor integration (VMI) for evaluation of micromotor efficiency of grapho-motor type. It also includes descriptive statistics results which clearly show trends of ontogenetic trends in the domain of integration of function of visual receptors on motor units. The difference in the process of visual-motor integration between boys and girls in particular phases has also been analysed. The obtained results show basis for further analysis of the research results of visual-motor integration in children of preschool and younger school age.

Key words: fine motor skills, grapho-motor skills, micromotor efficiency, primary education

INTRODUCTION

Visual-motor integration represents an extremely significant part in development of a child, and as such it represents a particularly important field of interest in studying humane ontogenetics. The term visual-motor integration refers to a process of coordinating functions of motor system with the information gained by vision. The result of that process is a possibility of performing fine motor activities that is improvement of micromotor efficiency. When studying visual-motor integration in children coordination of eyes and hand or fist muscles is most frequently studied, which enables precise manual activities. This complex process at the same time includes visual perception, as well as coordination of eyes and hands (Beery, 1989).

Process of visual-motor integration directly reflects dynamics of ontogenetic development and it is thus used as a demonstrator of neuro-motor development. Previous findings clearly indicate the importance of visual-motor integration in the process of education. This connection reflects firstly in the process of learning to write in which visual-motor integration represents a crucial factor, as well as in other academic skills such as reading and maths abilities, as well as in school success in general (Beery, 1982; Goldstein & Britt, 1994; Kaiser, Albaret & Doudin, 2009; Maeland, 1992; Matti-zassi, 1998; Oliver, 1990; Taylor, 1999; Weil & Amundson, 1994).

Preliminary research results of visual-motor integration in children aged 7 to 10 are presented in this paper. The research was conducted with the aim of studying development of micromotor efficiency as a significant part of entire ontogenetic development.

WORK METHODS

The research was conducted on a sample of 163 students from primary school Meje in Split aged 7 to 10 divided into two subsamples. Subsample of boys included 92 subjects, 30 first graders, 23 second graders, 20 third graders and 19 fourth graders, while the subsample of girls included 71 subjects, 19 first graders, 20 second graders, 18 third graders and 14 fourth graders. Measuring procedure was conducted in May 2015.

Measuring was conducted by application of the visual-motor integration test (VMI). This test was intended for evaluation of micromotor efficiency of grapho-motor type in children of preschool and early school age. The test consisted of three paths drawn on a paper of A4 dimensions with marked starting point and ending point of the path. Task of a subject was to draw a line with a pencil within the path from starting point to ending point as fast as possible. Interruption of the line or going out of the path was considered to be an error in performance. Total result of the test was calculated by adding number of errors multiplied by two to the time necessary for finishing the test.

When processing the data the parameters of descriptive statistics, mean and standard deviation (SD), were also calculated, and due to insight into particular quantitative relations of the subsamples of subjects percentage values were also calculated. Also, the obtained results are shown in graphics.

RESULTS

Parameters of descriptive statistics of the variables VMI_{time} , VMI_{errors} and VMI for boys and girls are shown in table 1. There is value mean as well as value of the related standard deviation (SD), and results are calculated separately for each grade.

Table 1
Descriptive statistics parameters.

		1 st grade		2 nd grade		3 rd grade		4 th grade	
		mean	SD	mean	SD	mean	SD	mean	SD
VMI_{time}	male	32,62	10,64	21,76	4,52	22,15	4,33	21,49	4,60
	female	28,25	8,59	21,00	4,43	20,75	5,41	20,01	4,28
VMI_{errors}	male	4,60	3,02	3,22	2,70	3,30	2,74	3,05	1,96
	female	3,63	2,63	4,65	2,68	3,78	3,78	2,36	1,82
VMI	male	41,82	10,17	28,20	4,12	28,75	7,05	27,59	6,18
	female	35,51	8,87	30,30	5,40	28,31	7,32	24,72	4,53

After analysing the parameters of descriptive statistics in students from the first grade it can be noticed that there is quantitative difference between results of male and female students in all variables. For finishing the test boys needed 32,62 seconds in average, while the girls finished the test in a shorter period of time that is in 28,25 seconds. Also, the girls made fewer errors, 3,63 in average, unlike boys of the same age who made 4,60 errors while doing the test. According to the values of variables VMI_{time} and VMI_{errors} girls achieved better result in total VMI test, which totals 35,51 for them, and 41,82 for boys.

In second graders the time difference for finishing the test is significantly lower between boys and girls, so boys finish the test in 21,76 seconds in average, and girls in 21 second. However, unlike the subsample of first graders, in second grade girls make more errors than boys while doing the test, that is 4,65 to 3,22. After condensing the mentioned data into a unified result, values of the variable VMI are in boys' favour who achieve the total result of 28,20 while the result achieved by girls is 30,30.

In third grade a slight increase of difference in time necessary for finishing the test can be noticed between the subsample of subjects. So, girls achieve

better result of 20,75 seconds, while boys need 22,15 second to finish the test. Similar to results for second graders, girls in third grade also make more errors. However, the difference is significantly lower, 3,78 to 3,30. It all resulted in quite unified results of the total VMI test, which for girls totals 28,31, and 28,75 for boys.

Analysis of value of the variable VMI_{time} in fourth graders indicates similar relation of values registered in third graders as well. So girls achieve somewhat better result than boys, and they finish the test in 20,01 seconds in average unlike boys who need 21,49 seconds to finish the test. However, the difference in trend in relation to third graders is noticeable in the variable VMI_{errors} . In the fourth grade, namely, boys make significantly more errors while doing the test, 3,05 in average, in relation to girls who make 2,36 errors in average. Such values of the mentioned two variables result in additional increase of the difference between subsamples of subjects in the total result of the VMI test, which totals 24,72 for girls and 27,59 for boys.

After analysing the results quantitative difference in parameters of the test between subjects considering domination of the right that is left hand was noticed. The mentioned results are shown in table 2.

Table 2

Descriptive statistics parameters.

	right-handed		left-handed	
	mean	SD	mean	SD
VMI_{time}	24,47	8,17	21,95	6,34
VMI_{errors}	3,57	2,75	4,47	3,08
VMI	31,61	9,08	30,90	8,81

Chart 1

Right-handed and left-handed children proportion.

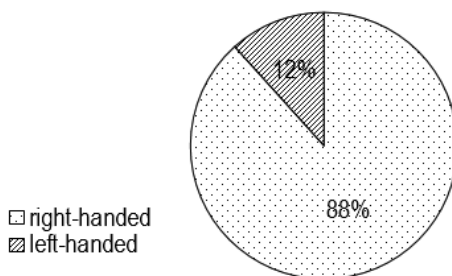

Descriptive parameters indicate a higher degree of visual-motor integration in left-handed subjects, which can be seen from the results of all three variables. The given test was finished by the left-handed subjects in 21,95 seconds in average, while the right-handed subjects took 24,47 seconds to finish the test. However, the left-handed subjects make more errors while doing the test than the right-handed subjects, 4,47 to 3,57. So the total result of the VMI test for the left-handed subjects totals 30,90 and 31,61 for the right-handed subjects.

However, due to the obvious disproportion between the number of the right-handed subjects and left-handed subjects, where the number of the left-handed subjects totals 19, 11 boys and 8 girls, that is 12% of the total sample, in relation to 144 right-handed subjects that is 88% of the total sample, the obtained results must be interpreted with reserve. Namely, researches indicate that the number of right-handed people in population totals from 70% to 90% ([Cardwell, Clark & Meldrum, 2000](#)), while there are only 10% of the left-handed population ([Hardyck & Petrinovich, 1977](#)). Being left-handed is more frequent in men than in women ([Papadatou-Pastou, Martin, Munafò & Jones, 2008](#)). Sample of subjects in this research without doubt reflects the condition of population, such relations of subsamples require a special methodological approach.

DISCUSSION

After analysing the obtained results as a whole it can be concluded that there is a trend of improvement of the VMI test results in the time function in both boys and girls. Both groups of subjects demonstrate improvement in degree of visual-motor integration between first and second grade. The mentioned improvement of results can be clearly seen from chart 2 which contains values of means for the variable VMI for both boys and girls and according to grades. Progress in degree of visual-motor integration is clearly related to the processes of growth and development, firstly of neuro-motor that is of sensori-motor functions. The obtained results are in conformity with previous knowledge which clearly indicate relation of ontogenetic development of a child and visual-motor integration ([Decker, 2008](#); [Decker, Englund, Carboni & Brooks, 2011](#); [Lin, Luo, Wu, Shen & Sun, 2015](#)).

Significant influence in the process of visual-motor integration in children definitely has the process of learning and exercising as well. Registered leap in

values of the VMI test between first and second grade indicate this conclusion. Namely, one of basic educational goals in first grade is acquiring the writing skill, so the curriculum content is significantly oriented towards achieving the mentioned goal. Since the ability of writing is from the aspect of neuromuscular control the grapho-motor ability, it is clear that the process of acquiring the writing skill will depend on degree of visual-motor integration and vice versa. Therefore, it can be assumed that the process of learning and exercising specific micromotor skills necessary for writing has a positive effect on the process of visual-motor integration in children. Previous research supports the mentioned statement and clearly indicates significant relation of the writing skill and visual-motor integration (Cornhill & Case-Smith, 1996; Maki, Voeten, Vauras, & Poskiparta, 2001; Tseng & Chow, 2000; Weil & Amundson, 1994; Weintraub & Graham, 2000).

As a part of the research the process of visual-motor integration in boys and girls was separately analysed. Obtained results indicate higher degree of visual-motor integration in subsample of girls in all grades except in second grade in which boys achieved somewhat better results in the VMI test.

Such results are consistent to the results of the research done by Flatters, Hill, Williams, Barber, and Mon-Williams (2014) who test differences between girls and boys in development of manual skills. Results of the mentioned research imply that girls in pre-puberty phase have better ability of manual control in performing new tasks. Still, the authors emphasize that based on the conducted research it is not possible to claim that girls and boys during education demand different approach in for development of manual skills.

CONCLUSION

Conducted research gave an insight into dynamics of visual-motor integration in children aged 7 to 10. Results clearly indicate tendency of increase in micromotor efficiency of grapho-motor type in process of growth and development. Particularly noticeable improvement was registered between first and second grade. These results imply a significant uplift of visual-motor integration in this life period, as well as positive effects of school curriculum on development of grapho-motor skills.

Also, obtained results indicated generally better results in subsample of girls with an exception in second grade in which boys achieved somewhat better results. It implies existence of certain movement in dynamics of visual-

motor integration between boys and girls, which obviously fades with time. Mentioned phenomenon requires further research with the aim of finding developmental mechanisms which potentially cause this phenomenon.

It can be concluded that visual-motor integration is scientifically quite an interesting field, which from kinesiological point of view requires further studying as an integrative part of ontogenetic development of a child.

REFERENCES

Beery, K. E. (1982). *Revised administration, scoring and teaching manual for the Developmental Test of Visual-Motor Integration*. Cleveland: Modern Curriculum Press.

Beery, K. E. (1989). *The Developmental Test of Visual-Motor Integration* (3rd ed.). Cleveland: Modern Curriculum Press.

Cardwell, M., Clark, L., & Meldrum, C. (2000). *Psychology for A-level* (2nd ed.). Glasgow: Collins Educational.

Cornhill, H., & Case-Smith, J. (1996). Factors that relate good and poor handwriting. *The American Journal of Occupational Therapy*, 50 (9), 732-739.

Decker, S. L. (2008). Measuring growth and decline in visual-motor processes with the Bender-Gestalt second edition. *Journal of Psychoeducational Assessment*, 26 (1), 3-15.

Decker, S. L., Englund, J. A., Carboni, J. A., & Brooks, J. H. (2011). Cognitive and Developmental Influences in Visual-Motor Integration Skills in Young Children. *Psychological Assessment*, 23 (4), 1010-1016.

Flatters, I., Hill, L. J. B., Williams, J. H. G., Barber, S. E., & Mon-Williams, M. (2014). Manual Control Age and Sex Differences in 4 to 11 Year Old Children. *Plos One*, 9 (2).

Goldstein, D. J., & Britt, T. W. (1994). Visual-motor co-ordination and Intelligence as predictors of reading, mathematics and writing language ability. *Perceptual and motor skills*, 78, 819-823.

Hardyck, C., & Petrinovich, L. F. (1977). Left-handedness. *Psychological Bulletin* 84 (3), 385-404.

Kaiser, M. L., Albaret, J. M., & Doudin, P. A. (2009). Relationship Between Visual-Motor Integration, Eye-Hand Coordination, and Quality of Handwriting. *Journal of Occupational Therapy, Schools, & Early Intervention*, 2, 87-95.

Lin, Q. S., Luo, J. F., Wu, Z. C., Shen, F., & Sun, Z. W. (2015). Characterization of fine motor development: Dynamic analysis of children's drawing movements. *Human Movement Science, 40*, 163-175.

Maeland, A. E. (1992). Handwriting and perceptual-motor skills in clumsy, dysgraphic and normal children. *Perceptual and Motor skills, 75*, 1207-1217.

Maki, H. S., Voeten, M. J. M., Vauras, M. M. S., & Poskiparta, E. H. (2001). Predicting writing skill development with word recognition and preschool readiness skills. *Reading and Writing: An Interdisciplinary Journal, 14* (7-8), 643-672.

Mati-zassi, H. (1998). Drawing performance in children with learning difficulties. *Perceptual and Motor skills, 87* (2), 487-497.

Oliver, C. E. (1990). A Sensorimotor program for improving writing readiness skills in Elementary-Age Children. *The American journal of occupational therapy, 44*, 111-116.

Papadatou-Pastou, M., Martin, M., Munafò, M. R., & Jones, G. V. (2008). Sex differences in left-handedness: a meta-analysis of 144 studies. *Psychological Bulletin 134* (5), 677-99.

Taylor, K. P. (1999). Relationship between visual motor integration skill and academic performance in kindergarten through third grade. *Optometry and vision science: official publication of the American Academy of Optometry, 76* (3), 159-163.

Tseng, M. H., & Chow, S. M. K. (2000). Perceptual-motor function of school-age children with slow handwriting speed. *American Journal of Occupational Therapy, 54* (1), 83-88.

Weil, M. J., & Amundson, S. J. C. (1994). Relationship between visuomotor and handwriting skills of children in kindergarten. *American Journal of Occupational Therapy, 48* (11), 982-988.

Weintraub, N., & Graham, S. (2000). The contribution of gender, orthographic, finger function, and visual-motor processes to the prediction of handwriting status. *The Occupational Therapy Journal of Research, 20* (2), 121-140.

Učiteljica - subjekt u nastavi Tjelesne i zdravstvene kulture u razrednoj nastavi

Nevenka Maras¹, Sunčica Delaš Kalinski¹, Hrvoje Sivrić²,
Damir Jurko³, Mihaela Pavlović¹

¹Faculty of Kinesiology, University of Split, Croatia

²College of Slavonski Brod, Croatia

³Faculty of Humanities and Social Science, University of Split, Croatia

ABSTRACT

The primary aim of this research was to determine the circumstances of performance and realization of Physical Education classes and the basic characteristic of teacher - the subject of the realization of the curriculum. An anonymous questionnaire consisting of 12 statements has been applied on the sample of 203 teachers in primary schools of Split-Dalmatia, Šibenik – Knin and Zadar County. Each statement was scored on a Likert scale of 5 degrees.

The final results have shown that more than 33% of teachers participating in this survey did not have the necessary equipment and materials, and they mostly have not used the gym for the realization of their Physical Education lessons, mostly with good reasons. They are confident about their knowledge and competences they have acquired regarding the realization of teaching, but more than 65% of the examinees have confirmed that during the demonstration they also describe the teaching theme, what is completely incorrect regarding the methodics of teaching and learning motor skills.

At the same time, the results of this survey have lead to a conclusion that frequent polemics and discussions about the realization of Physical Education teaching in primary schools have been justified. Physical Education classes should be performed with higher quality, thus the suggested solution was additional education of teachers. On the other hand, proposals that this important school subject should be taught by kinesiologists with Master's Degree (professors of Physical Education), suggested by certain kinesiologists, was also considered.

Key words: kinesiological education, competences, attitudes, assertions

UVOD

Cilj tjelesnog, zdravstvenog i odgojno-obrazovnog područja je podmirenje biopsihosocijalnih motiva za kretanjem kao izrazom zadovoljenja određenih potreba čovjeka, kojima se uvećavaju adaptivne i stvaralačke sposobnosti u suvremenim uvjetima života i rada (Findak i sur., 1987).

Kvaliteta rada učitelja razredne nastave direktno utječe na intelektualni i zdravstveni razvoj djece, kao i na pripremu učenika za rad s profesorima kineziologije u starijim razredima osnovne škole.

Obrazovanje učitelja je dinamičan i otvoren sustav koji uključuje kompetentnost, refleksiju, orijentiranost na teoriju, suradništvo, odgovornost te razvoj sposobnosti i stavova učitelja u svim domenama učiteljske profesije.

Postati kompetentan učitelj zahtjeva integraciju znanja, sposobnosti i djelovanja, čemu pridonosi kvalitetno planirana i ostvarena stručno-pedagoška praksa kao važan segment obrazovanja budućih učitelja. Dobro organizirano praktično osposobljavanje pretpostavlja partnerstvo fakulteta i škola-vježbaonica, suradnju s primjereno osposobljenim učiteljima-mentorima, kvalitetnu pripremu studenata za rad s učenicima u osnovnoj školi te analizu njihovih iskustava na osnovi stečenih teorijskih spoznaja. U procesu razvoja ključnih učiteljskih kompetencija neizostavna je integracija teorijskog i praktičnog udjela u programima inicijalnog obrazovanja. Pitanje kompetentnosti učitelja trajna je preokupacija znanstvene i stručne javnosti, ali i učenika i njihovih roditelja osobno motiviranih da odgojno-obrazovni proces protječe u humanom okruženju i ozračju te u prijateljskim i suradničkim odnosima. Pretpostavka za osiguravanje takvih uvjeta je pedagoška kompetencija učitelja koja se u procesu cijeloživotnoga obrazovanja trajno nadograđuje i usavršava. No činjenica je da odgojno-obrazovna praksa bilježi i primjere nedostatno kompetentnih učitelja te je obveza pozvanih (fakulteti koji obrazuju učitelje svih profila, Agencija za odgoj i obrazovanje, Ministarstvo znanosti, obrazovanja i sporta, i sl.) planirati, kreirati, provoditi i evaluirati programe permanentnoga stručnoga usavršavanja učitelja s ciljem podizanja razine njihove kompetentnosti. Kako bi bilo moguće izraditi primjerene programe koji bi na optimalan način odgovarali stvarnim potrebama suvremenih učitelja nužno je istražiti kompetencije te locirati „kritične točke“ prema kojima je potrebno usmjeriti programe obrazovanja i osposobljavanja učiteljica.

Kompetentan učitelj posjeduje i stalno unaprjeđuje sposobnosti i kvalitete razumijevanja, prihvaćanja i slušanja, uključivanja, djelovanja, preuzimanja inicijative, uvažavanja, pregovaranja, poticanja te osigurava uvjete za prepoznavanje i uspješno zadovoljavanje psihičkih, emocionalnih, duhovih potreba svakog pojedinca razredne zajednice (Kostović-Vranješ i Ljubetić, 2008).

Neljak i sur. (2011) definiraju kompetencije kao korisna znanja i postignuća koja se učinkovito mogu upotrijebiti u praktičnim okolnostima. Prema Findaku (1999) stjecanje i razvoj temeljnih kompetencija proizlazi iz potrebe primjerenog i stalnog prilagođavanja novim radnim i životnim situacijama.

Jedno od mogućih određenja pedagoški kompetentnoga učitelja je i ono koje nude Katz i McClellan (1999), a prema kojem se pedagoški kompetentnim učiteljem smatra onaj koji može iskoristiti poticaje iz svog okruženja i svoje osobne te postići dobre razvojne rezultate. Odnosno, to je onaj učitelj koji sebe doživljava kao osobu koja ima kontrolu nad svojim pedagoškim djelovanjem, odnosom s učenicima i roditeljima te se dobro osjeća u svojoj učiteljskoj ulozi (prema Milanović i sur., 2000).

Stoga, od pedagoški kompetentnog učitelja očekuje se da svoje stručno znanje, vještine i sposobnosti (Chivers, 1996; Coldron i Smith, 1999) stavi u funkciju svog pedagoškog djelovanja, ali i da svojim osobinama ličnosti (kao što su *emocionalna osjetljivost, kreativnost, kooperativnost, etičnost* itd.; Ljubetić i sur., 2007) bude pozitivan model za identifikaciju svojim učenicima te da tako bude autoritet koji će učenici dragovoljno slijediti.

Završetkom studija učitelji razredne nastave nisu dovoljno educirani i uvedeni u proces realizacije nastave jer na fakultetu nema dovoljno prakse u kojoj bi svi učitelji stekli određeno samopouzdanje za rad s djecom. Stručno-pedagoška praksa je integrirani dio sveukupnoga obrazovanja i osposobljavanja budućih učitelja. Njena je uloga povezivanje znanja iz područja edukacijskih znanosti i neposrednog iskustva koje studenti stječu tijekom praktične nastave. Temeljni cilj stručno-pedagoške prakse je stjecanje profesionalnih kompetencija specifičnih za pojedine nastavne predmete i područja, kao i za izvannastavnu i izvanškolsku djelatnost. Fakultet koji obrazuju učitelje uvode ih u samo mali dio onoga što trebaju znati jer na kraju svaki diplomirani učitelj kada ulazi u razred i sam zna da ono što je naučio nije dovoljno i da treba još mnogo rada i stručnog usavršavanja da bih bio barem većim djelom kompetentan za rad sa učenicima.

Kroz studij velika važnost se pridaje teorijskom dijelu nastave dok je praksa stavljena po strani. Istina svaki učitelj treba prvo znati osnovna teorijska znanja svakog predmeta koji će predavati, ali bez prakse sa učenicima učitelji nikad nisu do kraja spremni za osposobljavanje učenika za rad u razredu.

Primarni cilj ovoga istraživanja je utvrditi okolnosti izvedbe i realizaciju nastave *tjelesne i zdravstvene kulture* kao i osnovna obilježja učiteljice - subjekta u realizaciji nastavnog plana i programa.

METODE

Uzorak ispitanika definiran je sa 203 učiteljice razredne nastave sa područja Splitsko-dalmatinske, Šibenske i Zadarsko-kninske županije. Prosječna kronološka dob ispitanica je 42,09 godina, a prosječno radno iskustvo iznosi 21,47 godina.

Uzorak varijabli predstavlja skup od 12 tvrdnji koje se odnose na realizaciju nastave predmeta *Tjelesna i zdravstvena kultura (TZK)*, a koje su kvalitativno definirane u dva sadržajna područja: *Organizacija i provedba nastave tjelesne i zdravstvene kulture* (6 tvrdnji) te *Učiteljica - subjekt realizacije nastavnih sadržaja tjelesne i zdravstvene kulture* (6 tvrdnji).

Sve učiteljice obuhvaćene ovim istraživanjem dobrovoljno su ispunile upitnik u školskim prostorijama na anonimnan način. Sve tvrdnje procjenjivanje su na Likertovoj skali od 1-5 (1 – *Nikad*; 2 – *Rijetko*, 3 – *Ponekad*; 4 – *Često*; 5 – *Uvijek*). Prije ispunjavanja upitnika prethodilo je dodatno objašnjenje i svrha ovoga istraživanja.

Metode obrade podataka uključile su izračunavanje deskriptivnih statističkih pokazatelja: aritmetičke sredine (AS), standardne devijacije (SD), učestalosti i relativnih vrijednosti dva sadržajna područja odnosno 12 tvrdnji učiteljica razredne nastave. Podaci su obrađeni računalnim programima *Statistica Ver.11.00*.

REZULTATI

U tablici 1 prikazani su deskriptivni parametri, učestalosti i relativne vrijednosti 6 tvrdnji sadržajnog područja *Organizacija nastave Tjelesne i zdravstvene kulture*.

Tablica 1. Deskriptivni parametri, učestalosti i relativne vrijednosti sadržajnog područja *Organizacija nastave Tjelesne i zdravstvene kulture*.

TVRDNJE	AS±SD	NIKAD	RIJETKO	PONEKAD	ČESTO	UVIJEK
Nastavne sadržaje provodim u potpunosti prema nastavnom planu i programu	frek.	2	8	33	94	66
	4,05±0,86	%	0,99	3,44	16,26	46,31
Imam sve potrebne rekvizite i pomagala za provođenje nastave tjelesne i zdravstvene kulture	frek.	25	42	67	49	20
	2,99±1,16	%	12,32	20,69	33,00	24,14
Nastavu tjelesne i zdravstvene kulture izvodim u školskoj dvorani	frek.	48	21	39	74	30
	3,08±1,42	%	23,65	10,34	14,78	36,45
Učenci provode nastavu tjelesne i zdravstvene kulture u sportskoj odjeći i obući	frek.	6	10	28	66	93
	4,13±1,02	%	2,96	4,93	13,79	32,51
Provjeravam inicijalna stanja antropometrijskih karakteristika, motoričkih i funkcionalnih sposobnosti na početku svake školske godine	frek.	3	6	43	62	87
	4,11±0,94	%	1,49	2,99	21,39	30,85
Provodim nastavu tako da svaki učenik vježba u okviru svojih mogućnosti	frek.	0	6	15	75	106
	4,39±0,75	%	0,00	2,97	7,43	37,13

Legenda: AS - aritmetička sredina, SD - standardna devijacija, frek – učestalost, % - postotna vrijednost.

Analizom tablice 1 vidljivo je da najvišu prosječnu ocjenu odgovora učiteljica razredne nastave iz sadržajnog područja *Organizacija nastave Tjelesne i zdravstvene kulture* ima tvrdnja *Provodim nastavu tako da svaki učenik vježba u okviru svojih mogućnosti*, a najmanju tvrdnja *Imam sve potrebne rekvizite i pomagala za provođenje nastave tjelesne i zdravstvene kulture*. Više od 78% učiteljica tvrdi da nastavne sadržaje provodi u potpunosti prema nastavnom planu i programu, međutim potrebne nastavne rekvizite i pomagala nema više od 1/3 ispitanica te negdje oko 33% učiteljica ne koriste sportsku dvoranu za realizaciju nastave *Tjelesne i zdravstvene kulture*. Oko 8% učenika za vrijeme nastave nije u adekvatnoj sportskoj odjeći i obući, a 4,5% učenika nije

podvrgnuto inicijalnim mjerenjima antropološkog statusa na početku školske godine. Više od 97% učiteljica ima individualan pristup učenicima koji vježbaju u okviru svojih mogućnosti.

U tablici 2 prikazani su deskriptivni parametri, učestalosti i relativne vrijednosti 6 tvrdnji sadržajnog područja područja *Učiteljica – subjekt nastave Tjelesne i zdravstvene kulture*

Tablica 2. Deskriptivni parametri, učestalosti i relativne vrijednosti sadržajnog područja *Učiteljica – subjekt nastave Tjelesne i zdravstvene kulture*

TVRDNJE	AS \pm SD	NIKAD	RIJETKO	PONEKAD	ČESTO	UVIJEK	
Posjedujem dovoljno znanja i stručnosti za provedbu nastavnog predmeta tjelesna i zdravstvena kultura	4,06 \pm 0,77	frek.	1	4	37	101	60
		%	0,49	1,97	18,23	49,75	29,56
U potpunosti sam siguran/na u provedbi organizacijskih i metodičkih oblika rada	4,16 \pm 0,73	frek.	0	3	31	100	69
		%	0,00	1,48	15,27	49,26	33,99
Demonstriram osobno svaku novu nastavnu temu	3,88 \pm 0,92	frek.	2	12	51	80	56
		%	1,00	5,97	25,37	39,80	27,86
Nove nastavne teme poučavam samo metodom usmenog izlaganja	2,50 \pm 1,07	frek.	40	64	60	32	6
		%	19,80	31,68	29,70	15,84	2,97
Objašnjavanje nastavnih tema provodim prije demonstracije	3,99 \pm 0,93	frek.	2	12	41	79	69
		%	0,99	5,91	20,20	38,92	33,99
Dok demonstriram nastavnu temu istovremeno je usmeno opisujem	3,75 \pm 1,08	frek.	12	11	44	84	52
		%	5,91	5,42	21,67	41,38	25,62

Legenda: AS - aritmetička sredina, SD - standardna devijacija, frek – učestalost, % - postotna vrijednost.

U tablice 2 vidljivo je da najvišu prosječnu ocjenu odgovora učiteljica razredne nastave iz sadržajnog područja *Učiteljica – subjekt nastave Tjelesne i zdravstvene kulture* ima tvrdnja *U potpunosti sam siguran/na u provedbi organizacijskih i metodičkih oblika rada* (4,16 \pm 0,73), a najmanju tvrdnja *Nove nastavne teme poučavam samo metodom usmenog izlaganja* (2,50 \pm 1,07). Više od 70% učiteljica smatra da posjeduje dovoljno znanja i stručnosti za provedbu nastavnog predmeta *Tjelesna i zdravstvena kultura*, međutim samo 10% učiteljica dok demonstrira nastavnu temu istovremeno je usmeno ne opisuje, odnosno često ili uvijek to radi čak 66% učiteljica. Oko 72% učiteljica prije same

demonstracije motoričke kretnje objašnjava istu, a metodu usmenog izlaganja za sve nove nastavne teme koristi više od 50% ispitanica u ovom istraživanju. Učiteljice su u potpunosti sigurne u provedbi organizacijskih i metodičkih oblika rada. Samo 2,5 % učiteljica iskaziva nesigurnost u realizaciji nastave *Tjelesne i zdravstvene kulture*.

RASPRAVA

Rezultati dobiveni ovim istraživanjem, a temeljem samoprocjene i procjene 203 učiteljice razredne nastave na Likertovoj skali ocjena od 1-5, ukazuju na sveprisutnu problematiku izvođenja i realizacije nastave *Tjelesne i zdravstvene kulture* u nižim razredima osnovne škole (počev od materijalnih uvjeta rada, stručnosti te dostupnosti potrebnih rekvizita i pomagala).

Čak 48,77% kumulativnih odgovora *nikad, rijetko i ponekad* koji se odnose na realizaciju i provođenje nastave *Tjelesne i zdravstvene kulture* u školskoj dvorani i vježbalištu ukazuju na neadekvatne materijalne uvjete rada. Istome se može pridodati i podatak da 66,01% učiteljica nema potrebne rekvizite i pomagala za nastavne sadržaje. S druge strane više od 22% učenika nisu za vrijeme nastave u sportskoj odjeći i obući. Učiteljice prilagođavaju uvjete rada učenikovim sposobnostima; metodu usmenog izlaganja za sve nove nastavne teme koristi više od 50% učiteljica, dok 72,22% nikad, rijetko ili ponekad demonstrira novu nastavnu temu; više od 25% nikad, rijetko ili ponekad provjeravaju inicijalna stanja učenika na početku školske godine, a da pri tome nisu ni spomenuta tranzitivna i finalna provjeravanja, pravilnik i vremenik vrednovanja i ocjenjivanja.

S jedne strane učiteljice tvrde da su dovoljno stručne i sigurne u svoje znanje, da bi na tvrdnje *Objašnjavanje nastavnih tema provodim prije demonstracije* (oko 72%) i *Dok demonstriram nastavnu temu istovremeno je usmeno opisujem* (oko 67%) odgovorili često i uvijek. Naime, osnovna pravila metodike *Tjelesne i zdravstvene kulture*, kao i svih metodika kinezioloških angažiranosti govore o tome da se nastavna tema prvo opisuje, zatim demonstrira bez opisivanja te da se nakon demonstracije dodatno objašnjava i imitira pojedina motorička kretnja. Nakon uočavanja grješaka, vrši se analiza i korekcija motoričke kretnje ili znanja.

ZAKLJUČAK

Primarni cilj ovoga istraživanja bio je utvrditi okolnosti izvedbe i realizacije nastave *Tjelesne i zdravstvene kulture* kao i osnovna obilježja učiteljice - subjekta

u realizaciji nastavnog plana i programa. Na uzorku od 203 učiteljice nižih razreda osnovnih škola Splitsko-dalmatinske, Šibenske i Zadarsko-kninske županije primijenjen je upitnik od 12 tvrdnji na anonimnan način. Svaka tvrdnja procijenjena je na Likertovoj ljestvici od pet stupnjeva.

Iskazane tvrdnje učiteljica razredne nastave koje su sudjelovale u ovom istraživanju ukazuju na sveprisutnu nacionalnu problematiku realizacije nastave *Tjelesne i zdravstvene kulture*, a ne samo područja južne Hrvatske. Nedostatni materijalni uvjeti rada, nedostatak potrebnih rekvizita i pomagala, škole bez sportske dvorane, nepotpuna realizacija fonda sati, neadekvatna sportska odjeća i obuća učenika za vrijeme nastave, nedovoljna educiranost i sl., ipak su dio svakodnevnice nastavnog predmeta *Tjelesna i zdravstvena kultura* u nižim razredima osnovnih škola.

Učiteljice razredne nastave svojim tvrdnjama ukazuju da su sigurne u svoje znanje i kompetencije koje imaju za provođenje nastave, ali velika većina učiteljica potvrdila je da za vrijeme demonstracije ujedno i opisuju nastavnu temu, vrše objašnjavanje, a ne opisivanje prije demonstracije. Više od polovine koristi samo metodu usmenog izlaganja kod novih motoričkih znanja, što je potpuno neispravno u metodici učenja i poučavanja motoričkih znanja.

Nalazi ovog istraživanja navode na razmišljanja kako je sve češća polemika i rasprava oko provođenja nastave *Tjelesne i zdravstvene kulture* u nižim razredima razložna.

Nastava *Tjelesne i zdravstvene kulture* trebala bi biti kvalitetnije realizirana te se preporučava rješavanje ovog problema sa dodatnom edukacijom učiteljica, ali i razmatranjem prijedloga kojeg zagovaraju neki kineziolozi kako bi ovaj važan nastavni predmet trebali provoditi magistri kineziologije (profesori tjelesne i zdravstvene kulture).

LITERATURA

Findak, V., (2009). Kineziološka paradigma kurikula tjelesnog i zdravstvenog odgojno-obrazovnog područja za 21. stoljeće. *Metodika*, 10(19), 371-381.

Chivers, G. (1996), Towards a holistic model of professional competence. *Journal of European Industrial Training*, 20(5), 20-31.

Coldron, J., & Smith, R. (1999), Active location in teacher's construction of their professional identities. *Journal of Curriculum Studies*, 31(6), 711-726.

Findak, V. (1999) *Metodika tjelesne i zdravstvene kulture*. Zagreb: Školska knjiga.

Findak, V., Mironović, R., Schmidt, I., & Šnajder, V. (1987) *Tjelesna i zdravstvena kultura u osnovnoj školi*. Zagreb: Školska knjiga.

Katz, L. G., McClellan, D.E. (1999). *Poticanje razvoja dječje socijalne kompetencije*. Zagreb: Educa.

Kostović - Vranješ, V., & Ljubetić, M.(2008). „Kritične točke“ pedagoške kompetencije učitelja. *Život i škola*, 20(2), 147-162.

Ljubetić, M., Arbunić, A., & Kovačević, S. (2007). Osobine učitelja – studentsko iskustvo. U: V. Kadum (ur.), *Zbornik radova Osmi dani Mate Demarina*. Pula: Sveučilište Jurja Dobrile u Puli, Odjel za obrazovanje učitelja i odgojitelja.

Milanović, M., Stričević, I., Maleš, D., & Sekulić-Majurec, A. (2000). *Skrb za dijete i poticanje ranog razvoja djeteta u Republici Hrvatskoj*. Zagreb: UNICEF-Ured za Hrvatsku i Ministarstvo prosvjete i športa RH, Targa.

Neljak, B., Markuš, D., Trstenjak, B. & Višković, S.(2011). Kompetencije u tjelesnom i zdravstvenom odgojno obrazovnom području: procjena učeničke važnosti. U: I. Prskalo & D. Novak (Ur.), *6Th Fiep European Congress/6. Fiep europski kongres, Tjelesna i zdravstvena kultura u 21. stoljeću –kompetencije učenika*, Poreč (str. 345-354). Zagreb: Hrvatski kineziološki savez.

Structure of the anthropometric characteristics of youth volleyball players

Vildane Jasari¹, Josko Milenkovski², Abedin Ibrahimimi¹,
Stipe Blažević³, Žarko Kostovski²

¹High School Pjeret Bogdani, Uroševac, Kosovo

*²University St. Cyril and Methodius, Faculty for Physical Education Sport
and Health – Skopje, Macedonia*

³Faculty of Economics, University of Rijeka, Croatia

ABSTRACT

The survey was conducted on a sample of 70 female volleyball players 14-16 years old, members of the OK "Kastrioti" from Ferizaj. For the purposes of this research 12 variables for anthropometric measures were applied. With the processing of the obtained data, basic central and dispersion parameters were applied, and also factor analysis with varimax and rotated varimax solution were used. With the factor analysis three different factors were determined. The first factor explains the latent space of the body voluminosity, the second factor was defined as body longitudinality and the third factor was the factor of subcountenous adipose tissue.

Key words: factor analysis, athletes, volleyball, female

INTRODUCTION

Volleyball training requires knowledge of training theory, game tactics, biomechanics, automation of sports techniques and functional mechanisms for energy engagement (Raiola, G., 2011). Some research related with the antropometric dimensions of female volleyball players suggest results that body height remains the important factor of success in volleyball players.

While the body height is genetically determined and virtually impossible to modify, the lean body mass is the modifiable factor that should be regularly monitored and adjusted in volleyball players. The study offers solid reference values for the anthropometric evaluation of volleyball players. (Zadraznik, M. and Dervisevic, E. 2011). Evaluation of anthropometric characteristics can be performed with two methods, namely direct evaluation and indirect evaluation. Direct evaluation adopts absolute values of the anthropometric data, while indirect evaluation is achieved through converting the anthropometric data into corresponding derived indices (Tan and Chou, 2003). In sports related research, anthropometric methods are widely applied in the recruitment of potential athletes. Different sports have different anthropometric characteristics, therefore specific anthropometric variables should be used for talent identification in different sports (Zhang, Y. 2010). Perfecting the methodology for developing physical features is of a great importance not only to improve performance in sports, but also in areas which require great physical exertion for achievement of the planned goals.

Programme contents used in sports such as volleyball, strongly influence the development of the anthropological characteristics and quality of technical and tactical knowledge of volleyball, and often are decisive factor in achieving the final result in this sport. Volleyball belongs to sport activities in which anthropometric characteristics of its participants influence the level of sport performance. It was established that volleyball players compared to most other athletes have distinctive anthropometric characteristics (Ugarkovic, D. 2004).

RESEARCH METHOD

For realization of this project, the research was conducted on a sample of 70 respondents, female students at the age of 14-16 years, from the elementary school "Tefik Čanga" and the elementary school "Đon Sereči" from Ferizaj. The respondents are female students from VII to IX grade of these schools, members of OK "Kastrioti" from Ferizaj. The main objective of the research is to determine the anthropometric characteristics of youth female volleyball players 14-16 years old. For the realization of this research the following measuring instruments for assessment of the anthropometric characteristics were

applied: body height (ABH), body mass (ABM), leg length (ALL), arms length (AAL), volume of the chest (AVCH), volume of the humerus (AVH), volume of the femur (AVF), volume of the tibia (AVT), shoulders width (ASHW), thickness of the back skinfold (ATBS), thickness of the abdomen skinfold (ATAS), thickness of the tibia skinfold (ATTS). (Šoš, H., Radjo, I., 1998). The metric characteristics of the variables, the problem, subject, purpose and hypothesis of this research, also the characteristics and size of the sample, determined the basic method for processing the results obtained in this study. (Malacko, J. Popović, D. 2001). The data in this study were processed using the software system for univariate and multivariate data analysis. Analyses were processed in the programs: Exell for Windows, Statistica 12.0 for Windows IBM SPSS 20.0 for Windows. The variables that were used in this research were processed using standard descriptive methods. The basic central and dispersion parameters were calculated in order to determine the functions of their distribution. This way it was possible to test the hypothesis or the normality of the distribution of the obtained results and it was tested using Kolmogorov-Smirnov method. For the obtained results the following parameters were calculated: arithmetic mean (Mean), standard deviation (St.dev), minimum value (min), maximum value (max). The hypothesis that some variable is normally distributed will be tested on the basis of the measures: Skewness - symmetry of the distribution of the result, Kurtosis - curvature of the distribution of the results. For determining the structure of the anthropometric characteristics of female players at the age of 14-16 years old who are engaged in sports (volleyball), factor analysis, orthogonal varimax solution with Kaiser-Guttman criterion were applied.

RESULTS AND DISCUSSION

Table 1 presents the data for the anthropometric descriptive statistics parameters for respondents-female volleyball players (N = 70). For the purposes of this study the following parameters were calculated: arithmetic mean (mean), minimum value (min), maximum value (max), standard deviation (std. dev.). To test the normality of the distribution the following results are presented: the results of the asymmetry coefficients (Skw), results of the coefficient of curvature (Kurt) and Kolmogorov-Smirnov method (max D).

Table 1 Descriptive statistic parameters for respondents-female volleyball players

	Valid N	Mean	Min	Max	Std.Dev.	Skew	Kurt	max D	p
ABH	70,00	161.42	151,00	174,30	6,21	0,11	-0,93	0,08	p > .20
ABM	70,00	54.72	41,00	72,20	7,55	0,24	-0,38	0,05	p > .20
ALL	70,00	98.39	88,00	111,00	4,39	-0,19	0,47	0,08	p > .20
AAL	70,00	70.87	62,10	80,00	3,75	0,12	-0,14	0,05	p > .20
AVCH	70,00	83.39	68,50	93,50	5,09	-0,28	0,35	0,07	p > .20
AVH	70,00	25.95	20,80	32,50	2,76	0,49	-0,26	0,09	p > .20
AVF	70,00	54.30	44,20	68,90	4,93	0,38	0,10	0,07	p > .20
AVT	70,00	35.14	28,70	41,00	2,22	-0,25	0,78	0,07	p > .20
ASHW	70,00	37.10	32,80	42,00	1,99	0,35	-0,06	0,12	p > .20
ATBS	70,00	6.43	4,00	13,00	1,98	1,15	1,74	0,26	p < ,01
ATAS	70,00	10.79	4,00	18,00	3,44	0,22	-0,64	0,15	p < ,10
ATTS	70,00	11.74	4,00	18,00	3,07	-0,12	-0,67	0,11	p > .20

If we analyze the results presented in Table 1 it can be concluded that: Statistically significant deviations from asymmetry of the results values (Skew), can be seen in the variable (ATBS, Skew = 1,15). The degree of curvature of the curve at the top (Kurt), did not significantly differ in any of the variables in the anthropometric space. If we analyze the results obtained from the coefficient of the normal distribution of results (max D), we can conclude that only in one (1) variable from the anthropometric space exists statistically significant differences. Deviation at level of $p < 0,01$ can be observed in the variable Thickness of the back skinfold (ATBS). Based on the results we can conclude that the sample of respondents according the anthropometric measures is quite homogeneous.

Based on the inter correlation matrix applied on the anthropometric variables were obtained characteristic roots (lambda), which explains the common variance of each isolated main component (Table 2). By applying the Kaiser-Guttman criterion, three significant latent dimensions were set aside which are explaining 78.36% of the total variance of the entire system.

Table 2 Characteristical roots of the explained variance

	Eigenval	% total Variance	Cumul. Eigenval	Cumul. %
1	5,60	46,64	5,60	46,64
2	2,73	22,77	8,33	69,41
3	1,07	8,96	9,40	78,36

Table 3 shows the value of communality of the significant main components. The value of the communality of the treated anthropometric variables ranged from medium to high and very high results, which means that the factor system relatively well defined variability and co variability of the manifest variables.

Table 3 Significant main components and values of communality.

	From 1 Factor	From 2 Factors	From 3 Factors	Multiple R-Square
ABH	0,20	0,89	0,90	0,86
ABM	0,91	0,91	0,95	0,94
ALL	0,12	0,91	0,92	0,86
AAL	0,14	0,89	0,90	0,85
AVCH	0,46	0,48	0,57	0,47
AVH	0,59	0,68	0,83	0,74
AVF	0,73	0,76	0,86	0,87
AVT	0,73	0,77	0,78	0,77
ASHW	0,51	0,55	0,70	0,62
ATBS	0,31	0,44	0,61	0,44
ATAS	0,39	0,51	0,67	0,57
ATTS	0,49	0,53	0,70	0,63

Varimax solution which is presented in Table 4 led to creation of the structures which in this case poorly satisfy the simplicity of the structure, because a number of manifest variables have common projections in certain factors, and they belong to different hypothetical subspaces. From the height of the projections of the manifest variables on the first main component of the unrotated factor matrix, it can be concluded that most of the variables are with significant and high projections, which would mean that the obtained factors are highly correlated. The orthogonal projection of the main components is shown in Table 5, where from the obtained results it is reaching to the fact that that it can better explained the interpretation of the factors. High and very high projections of the variables for assessment of the volume of the body and a high projection in body mass constitute the first latent dimension. These variables are representatives of the hypothetical anthropometric subspace or they are defining the voluminosity of the body. Because of these arguments this factor can be defined as a factor of voluminosity.

Table 4 Varimax solution

	Factor 1	Factor 2	Factor 3
ABH	0,44	-0,83	-0,11
ABM	0,96	-0,04	-0,18
ALL	0,34	-0,89	0,07
AAL	0,38	-0,87	0,11
AVCH	0,68	0,14	-0,31
AVH	0,77	0,29	-0,38
AVF	0,86	0,16	-0,33
AVT	0,86	0,18	-0,12
ASHW	0,72	-0,18	0,40
ATBS	0,56	0,36	0,41
ATAS	0,63	0,35	0,39
ATTS	0,70	0,19	0,41
Expl.Var	5,60	2,73	1,07
Prp.Totl	0,47	0,23	0,09

Table 5 Rotated varimax solution

	Factor 1	Factor 2	Factor 3
ABH	0,22	0,92	-0,06
ABM	0,82	0,35	0,39
ALL	0,02	0,96	0,01
AAL	0,03	0,95	0,07
AVCH	0,73	0,07	0,18
AVH	0,88	-0,05	0,22
AVF	0,88	0,11	0,28
AVT	0,76	0,11	0,44
ASHW	0,25	0,45	0,67
ATBS	0,24	-0,12	0,73
ATAS	0,29	-0,08	0,76
ATTS	0,31	0,09	0,77
Expl.Var	3,68	3,05	2,68
Prp.Totl	0,31	0,25	0,22

High and very high measures of body length constitute the second latent dimension. From the saturated measures in this factor we can clearly define that it is a factor of longitudinal dimensionality of the respondents – female volleyball players. For the third factor it can be said that is clearly defined and it consists of three measures of body skinfold. It means that this factor we can define as a factor of subcutaneous adipose tissue. The research points to its disadvantages or that in a further study of this kind should also include measures for the assessment of the motor abilities of female volleyball plyers. Comparing the result with Yuan (1982), where it was suggested on some other anthropometric characteristics identification for juvenile volleyball players, such as longer toes (especially the second toes), longer hands and feet, narrower pelvis and ankles, high flexibility, and the growth showing a promising taller height with the obtained results from this research, we come to the realization that female volleyball players with greater measures in body volume, narrower pelvis, longer limbs and smaller levels of subcutaneous adipose tissue are ideal profiles for selection of young female volleyball players.

CONCLUSION

The survey was conducted in order to determine the structure of the anthropometric space for youth volleyball players. For realization of the survey 12 variables for assessment of the anthropometric measures of female volleyball players were applied. From the analysis of the obtained results it can be concluded that it is a relatively homogeneous group of female volleyball players, which is confirmed by the asymmetry coefficients of the result values, the degree of curvature of the top of the curve and the normal distribution coefficient of the results. In the further processing of the results by applying the factor analysis (varimax and rotated varimax solution) in the anthropometric space, three factors that are defining the characteristics of the female volleyball players were established. High and very high projections of the variables give the right to define the factors. The first factor was defined as a factor of body voluminosity, the second factor defines the longitudinal dimensionality of the body and the third factor we can define as a factor of subcutaneous adipose tissue. From this type of research, it can be extracted useful information that would be of primary importance for the volleyball coaches in the selection of young players. It is recommended that in the future, this type of research to be expanded with variables from the motor space, in order to obtain more information for the selection of young volleyball players.

LITERATURE

Gaurav, V., Singh, Mandeep., & Singh, S. (2010) Anthropometric characteristics, somatotyping and body composition of volleyball and basketball players, *Journal of Physical Education and Sports Management* Vol. 1(3), pp. 28-32.

Gaurav, V., & Singh, A. (2014) Anthropometric characteristics of Indian volleyball players in relation to their performance level, *Anthropometric characteristics of Indian volleyball players in relation to their performance level*, *Turkish Journal of Sport and Exercise*, 16(1), 87-89

Malacko, J.; Popović, D. (2001) Metodologija kineziološko antropoloških istraživanja, 3 dopunjeno izdanje, Leposavić;

Metikoš, D., Hofman, E., Prot, F., Pinter, Ž., Oreb, G.: (1989): Mjerenje ba-
zičnih motoričkih dimenzija sportaša. Fakultet za fizičkukulturu Sveučilišta u
Zagrebu, Zagreb, 1989.;

Protić, M. & Valkova, H. (2011) Psychosocial aspects of player's engage-
ment to the sitting volleyball, *Acta Kinesiologica*, 5, 2: 12-16

Raiola, G. (2011) Theoretical, argumentative and empirical volleyball I.
study on body communication and its relation to anticipation skills: new per-
spectives of coaching formation, *Acta Kinesiologica* 5, 2: 22-30

Tan PP, Chou JS (2003) Sport statistics and Sport measurement, pp. 173-
174. Guilf: Guangxi Normal College Press.

Ugarkovic D. (2004) Biomedicinske osnove sportske medicine (Biomedical
foundations of sports medicine). Novi Sad.

Šoš, H., Radjo, I. (1998) Mjerenje u kineziologiji. Fakultet za fizičku kulturu,
Univerzitet u Sarajevu, Sarajevo, 1998.

Yuan WX (1982) The Recruitment of Volleyball Athletes. *Journal of Wuhan
Institute of Physical Education*, 1-8.

Zadraznik, M., & Dervisevic, E. (2011) Level of play related anthropometric
differences in volleyball players, *Br J Sports Med* 2011;45:542-543

Zhang, Y (2010) 'An investigation on the anthropometry profile and its re-
lationship with physical performance of elite Chinese women volleyball play-
ers', MSc thesis, Southern Cross University, Lismore, NSW.

Slovenian version of the goal orientations in exercise measure: a preliminary study with young athletes

Petra Dolenc

*University of Primorska, Science and research centre,
Institute for kinesiology research, Koper, Slovenia*

ABSTRACT

The Goal Orientations in Exercise Measure (Petherick & Markland, 2008) is a quite recent instrument for assessing goal perspectives in exercise domain. The present study investigated psychometric properties of the Slovenian version of the Goal Orientations in Exercise Measure in young male regular exercisers. Participants were 102 Slovenian basketball players between 10 and 17 years. Factor analysis confirmed the two-factor model of the original scale. Also, reasonable internal consistency for task and ego orientation subscales was determined. The results also supported the orthogonal nature of goal orientations. Age-related differences in goal orientations in exercise revealed that older basketball players scored higher in ego-oriented goals in comparison with younger players, while the two age groups did not differ in task-oriented goals.

It can be concluded that the adapted version of the instrument show appropriate psychometric properties, including its factorial validity and reliability, and it may allow for a broader understanding of the motivational processes implicated in exercise-related settings among Slovenian youth.

Keywords: motivation, goal orientations, validation, questionnaire, sport

INTRODUCTION

Motivation plays a crucial role in physical activity and sport as it influences why and how athletes engage in the activities they choose, affecting the quality of their involvement as well as the outcome of their efforts (Chin, Khoo & Low, 2012). According to the Achievement Goal Theory (Nicholls, 1992) the need for competence can be realized within the sport context and each athle-

te's motivation is shaped by different goals and behaviours. The types of goals individuals select to define their version of success in exercise represent evidence for goal orientation (Duda & Treasure, 2010). A person can be orientated towards the task, defining success in exercise based on self-referenced criteria (e.g., increasing effort) or can be orientated towards the ego, defining success in exercise based on the adequacy of personal ability and the demonstration of superior competence compared with other people who exercise (Petherick & Markland, 2008). Task-oriented athletes view success as the mastery of a certain task, but also feel competent when showing improvements or progressing and giving a good effort. On the other hand, ego-oriented athletes attempt to compete and dominate other players (Petherick & Markland, 2008). Furthermore, they apply normative criteria for defining success or failure in sport, focusing primarily on the result of competition and performance (Roberts, Treasure & Conroy, 2007).

There is some evidence that achievement goals in youth sport are related to beliefs about sport success, the nature of sport ability and the purposes of sport participation, thus, they can influence engagement in physical activity (Kilpatrick, Bartholomew & Riemer, 2003). Goals help sport performance in different ways, the most important of which is giving the athletes something to focus on during training and then using that focus to mark their progress (Duda & Treasure, 2010). Goals also act as landmarks for evaluating progress, and allow coaches to see how athletes view their own potential, talent, and abilities (Duda & Treasure, 2010).

To assess individual differences in proneness for task or ego goal orientation in sport few questionnaires were developed by sport psychology researchers. Two major measures are the Task and Ego Orientation in Sport Questionnaire (TEOSQ; Duda & Nicholls, 1992) and Perceptions of Success Questionnaire (POSQ; Roberts, Treasure & Belague, 1998). The TESQ is the most extensively employed questionnaire for assessing goal orientations which has shown good construct validity, as well as internal consistency reliability in different samples, including various sports, competitive levels, and nationalities. More recently, a new instrument was designed by Petherick and Markland (2008), the Goal Orientations in Exercise Measure (GOEM). It has proved to be theoretically and statistically sound measure of goal perspectives in exercise domain.

The purpose of this study was to translate the GOEM into Slovenian language and examine the psychometric properties of the adapted version of the measure among young exercise participants. In addition, age-related differences in goal orientations were examined among participants.

METHODS

Participants

The sample consisted of 102 young male athletes aged between 10 and 17 years ($M = 13.08$, $SD = 2.46$). They were all member of three basketball clubs in the Coastal region of Slovenia. Written consent for participation in the study was obtained from the parents of participants.

Instrument

Goal Orientations in Exercise Measure (GOEM; Petherick & Markland, 2008) is a 10-item inventory that assesses individual differences in the ways that people construe their perception of success related to their physical activity. Two major goal perspectives are evaluated: task-oriented goals (e.g., „I exercise to the best of my ability“) and ego-oriented goals (e.g., „Other people who exercise don't do as well as me“). The responses are scored on a 5-point Likert scale ranging from 1 (Strongly disagree) to 5 (Strongly agree). Higher scores in each dimension are indicative of greater orientation toward task and ego goals. Internal consistency of the original instrument was .78 and .88 for task and ego subscales, respectively. Evidence of construct validity was shown with task goal orientation being positively related to intrinsic, identified, and introjected motivational regulations, and to perceived ability. Further, ego goal orientation was positively related to introjected and external motivational regulations, perceived ability, and perceived threat (Petherick & Markland, 2008).

The Slovenian version of the GOEM was developed using the standard back-translation procedure. The author initially translated the original scale developed in English into Slovenian language, and this version was then re-translated back into English by an independent translator unfamiliar with the original scale. The two translators then resolved minor differences that emerged during the back-translation process and reached consensus on the final version of the measure.

Procedure

Participants were briefly informed about the purpose of the study and received clear instructions on how to fulfill the measure. The completion of the scale was carried out in small groups and took approximately ten minutes. Individual responses were kept confidential.

Results

Principal Component Analysis with Varimax rotation was used to determine the factor structure of the instrument. Prior to the extraction of the factors, the Kaiser-Meyer-Olkin measure of sampling adequacy (KMO) and the Bartlett's test of sphericity were tested. The value of the KMO was .74, indicating suitability of the respondent data for factor analysis. The Bartlett's test was significant ($\chi^2 = 344.84, p = .000$).

In the table 1, the item means, standard deviations and standardized factor loadings are presented. Two factors with eigenvalues higher than 1.0 emerged with exactly the same factor structure as in the original version of the inventory. These two factors accounted for 58.62% of the total variance.

Table 1: Parameter estimates for the GOEM items (Slovenian version)

Items	Factor loadings			
	F1(Ego)	F2(Task)	M	SD
GEOM 1	.18			
GEOM 2	.64	.58	4.46	0.90
GEOM 3	.10	.12	1.94	1.08
GEOM 4	.02	.85	4.48	0.87
GEOM 5	.80	.67	4.41	0.97
GEOM 6	.12	.13	2.81	1.29
GEOM 7	.76	.78	4.37	0.89
GEOM 8	.84	.07	2.52	1.17
GEOM 9	.19	.11	2.36	1.15
GEOM 10	.83	.77	4.30	0.95
		.09	2.69	1.26
% Variance	34.15			
% Total Variance	58.62	24.47		

Standardized factor loadings ranged from .64 to .84 for the five ego orientation items and .58 to .85 for the five task orientation items. The inter-factor correlation was non-significant ($r = .12, p = .24$), and the Cronbach's alpha internal consistency coefficients were high, .84 and .78, for ego and task orientation, respectively. Mean values revealed that participants were higher on task orientation subscale, while larger standard deviations were observed in the ego orientation subscale reflecting greater response variability.

Independent t-test was conducted to examine the differences in goal orientations between younger (10-13 yaers) and older (14-17 years) basketball players. Results are presented in the table 2, indicating that older participants scored higher in ego orientation subscale compared to younger participants ($p < .05$), whereas the two age groups did not differ significantly in taks orientation subscale.

Table 2: Differences in ego and task orientation between younger and older participants

		M	SD	t	p
Ego orientation	Younger (n=63)	2.40	.95	-2.33	.02
	Older (n=39)	2.88	.97		
Task orientation	Younger (n=63)	4.41	.76	0.14	.89
	Older (n=39)	4.39	.53		

DISCUSSION AND CONCLUSIONS

With regard to the main propose of the study, the results confirmed the two-factor solution of the Slovenian version of the Goal Orientations in Exercise Measure, which is consistent with the structure hypothesized in the original scale developed by Petherick & Markland (2008). Our results revealed good psychometric properties of the measure including its factorial validity (i.e. each item loads on respective factor according the original model) and reliability (i.e. acceptable internal consistency coefficietns for task and ego subscales). For each set of items, the standardized factor loadings were all fairly high, indicating good convergent validity. The low non-significant correlation between task and ego goal orientation suggests that the two dimensions can

be considered orthogonal i.e., independent constructs which is congruent with the assumptions of achievement goal theory (Nicholls, 1992) and in line with previous research (Barić & Horga, 2006; Petherick & Markland, 2008). Thus, a person can be high or low on both dimensions, or high on first and low on second dimension or vice versa.

The sample of basketball players participating in the study showed greater levels of task orientation than ego orientation, which indicates that their success was more often defined through personal improvement and effort than through winning and beating others. Also, numerous studies conducted on adolescent athletes provided similar findings (Cid et al., 2009; Barić & Horga, 2006; Sari, Ilić & Ljubojević, 2013).

A predominantly task-oriented goal perspective has been associated with a more preferable pattern of determining goals in the physical activity domain, especially among young people. Namely, research has shown that task goal orientation fosters intrinsic motivation, while ego orientation is usually positively correlated with extrinsic motivation. Furthermore, positive emotional experiences are more likely in task-oriented environments (Bortoli, Bertollo & Robazza, 2009).

The results showed that age at least partially affected motivational orientations. Both age groups were very similar with regard to task-oriented goals, whereas older participants were more ego-oriented than younger ones. This can mean that the increasing physical exercise levels are reflected in the modification of goals in athletes. The transition to a higher category means that sport becomes increasingly competitive and highly selective, which means greater focus on results and winning. As pointed out by Barić and Horga (2006), sport is a competitive activity in its nature and ego orientation is not undesirable as long as it is not highly emphasized and accompanied with low task orientation.

The present contribution provides preliminary data on the adaptation of the goal orientation instrument in a particular sport setting. The obtained results show that the Slovenian version of GOEM is a valid and reliable measure, which is suitable for use within exercise context among young athletes. However, it should be mentioned that the study comprised only a relatively small sample of young team-sport athletes, who were all males. Therefore, additional validation of the instrument is needed in the future. Further examination should also include females, adolescents from different type of sports, training experience, level of competition or achievements. The measure may also serve as valuable tool for determining motivational aspects within school physical education.

Aknowledgements

Data for the study were obtained within the research project »UP za košarko«, funded by the Foundation for Sport and carried out in 2013 by the Institute for Kinesiology Reserach, Science and Research Centre, University of Primorska.

REFERENCES

Barić, R., & Horga, S. (2006). Psychometric properties of the Croatian version of task and ego orientation in sport questionnaire (CTEOSQ). *Kinesiology*, 38, 135-142.

Bortoli, L., Bertollo, M., & Robazza, C. (2009). Dispositional goal orientations, motivational climate, and psychobiosocial states in youth sport. *Personality and Individual Differences*, 47, 18-24.

Cid, L., Moutão, J., Leitão, J. C., Alves, J., & Petherick, C. (2009). *The Measurement of a goal orientation perspective in exercise. Confirmatory factor analysis of the Goal Orientation in Exercise Measure (GOEMp) – Portuguese Version*. Paper presented at the The 12th ISSP World Congress of Sport Psychology, Marrakech, Morocco.

Chin, N.S., Khoo, S. & Low, W.Y. (2012). Self-Determination and Goal Orientation in Track and Field. *Journal of Human Kinetics*, 33, 151-161.

Duda, J. & Nicholls, J. (1992). Dimensions of achievement motivation in schoolwork and sport. *Journal of Educational Psychology*, 84, 290-299.

Duda, J.L., & Treasure, D.C. (2010). Motivational processes and the facilitation of quality engagement in sport. In J.M. Williams (Ed.), *Applied Sport Psychology* (pp. 59-80). New York, NY: McGraw-Hill.

Kilpatrick, M., Bartholomew, J., & Riemer, H. (2003). The measurement of goal orientations in exercise. *Journal of Sport Behavior*, 26(2), 121-136.

Nicholls, J.G. (1992). The general and the specific in the development and expression of achievement motivation. In G.C. Roberts (Ed.), *Motivation in Sport and Exercise* (pp. 31-57). Champaign, IL: Human Kinetics..

Petherick, C., & Markland, D. (2008). The Development of a Goal Orientation in Exercise Measure (GOEM). *Measurement in Physical Education and Exercise Science*, 12, 55-71.

Roberts, G. C., Treasure, D. C., & Conroy, D. E. (2007). Understanding the Dynamics of Motivation in Sport and Physical Activity: An Achievement Goal Interpretation. In G. Tenenbaum & R. C. Eklund (ur.), *Handbook of Sport Psychology, Third Edition* (pp. 1-30). NJ: Hoboken: John Wiley & Sons.

Sari, İ., Ilić, J., & Ljubojević, M. (2013). The comparison of task and ego orientation and general self-esteem of Turkish and Montenegrin young basketball players. *Kinesiology*, 45(2), 203-212.