

# Proučavanje kemijskog sastava antarktičkog lišaja *Stereocaulon glabrum*

---

Medaković, Damjan

Master's thesis / Diplomski rad

2023

*Degree Grantor / Ustanova koja je dodijelila akademski / stručni stupanj:* **University of Split, Faculty of Chemistry and Technology / Sveučilište u Splitu, Kemijsko-tehnološki fakultet**

*Permanent link / Trajna poveznica:* <https://urn.nsk.hr/urn:nbn:hr:167:988496>

*Rights / Prava:* [In copyright](#) / [Zaštićeno autorskim pravom.](#)

*Download date / Datum preuzimanja:* **2024-07-09**

*Repository / Repozitorij:*

[Repository of the Faculty of chemistry and technology - University of Split](#)



**UNIVERSITY OF SPLIT**  
**FACULTY OF CHEMISTRY AND TECHNOLOGY**

**STUDY OF CHEMICAL COMPOSITION OF ANTARTIC SPECIES**  
***Stereocaulon glabrum***

**MASTER THESIS**

**DAMJAN MEDAKOVIĆ**

**Parent number: 171**

**Split, 2023.**



UNIVERSITY OF SPLIT  
FACULTY OF CHEMISTRY AND TECHNOLOGY  
MASTER STUDY OF CHEMISTRY  
ORGANIC CHEMISTRY AND BIOCHEMISTRY

STUDY OF THE CHEMICAL COMPOSITION OF THE ANTARTIC  
LICHEN *Stereocaulon glabrum*

MASTER THESIS

DAMJAN MEDAKOVIĆ

Parent number: 171

Split, 2023.  
SVEUČILIŠTE U SPLITU

**KEMIJSKO-TEHNOLOŠKI FAKULTET**

**DIPLOMSKI STUDIJ KEMIJE**

**ORGANSKA KEMIJA I BIOKEMIJA**

**PROUČAVANJE KEMIJSKOG SASTAVA ANTARKTIČKOG  
LIŠAJA *Stereaulon glabrum***

**DIPLOMSKI RAD**

**DAMJAN MEDAKOVIĆ**

**Matični broj: 171**

**Split, 2023.**

**BASIC DOCUMENTATION CARD**

## MASTER THESIS

University of Split  
Faculty of Chemistry and Technology  
Master study of Chemistry

**Scientific area:** Natural sciences

**Scientific field:** Chemistry

**Supervisor:** Ivica Blažević, PhD, Full Prof.

**Co-supervisor:** Juan Carlos Garcia Gallindo , PhD, Assoc. Prof.

### STUDY OF THE CHEMICAL COMPOSITION OF THE ANTARTIC LICHEN *STEREOCAULON* *GLABRUM*

Damjan Medaković, 171

**Abstract:** *Stereocaulon glabrum* is a species in the genus *Stereocaulon*, which is part of the Stereocaulaceae family. This lichen presents distinctive traits and it is a potential source of significant secondary metabolites. Understanding *S. glabrum*'s chemical composition is of importance for investigating its possible applications in disciplines such as pharmaceuticals. *Stereocaulon* genus is distinguished by its crustose-type primary thallus and fruticose type secondary thallus. This species can be found colonizing numerous substrates, such as rocks, soil, and tree bark, and is distributed across various geographical regions, making it a very good candidate in terms of quantity for future applications. According to earlier research, *Stereocaulon* genus synthesizes a wide range of secondary metabolites that support the organism's biological functions, chemical interactions with its environment and also has potential in medicinal applications. These metabolites include depsides, depsidones, dibenzofurans, and other specific chemicals. Almost all of them are of phenolic nature displaying a diverse range of chemical structures. The typical secondary metabolites in the *Stereocaulon* genus are stictic acid, atranorin, lobaric acid, and other phenolic compounds. In order to identify similarities and potential differences in molecular identification, we will compare the compounds that we have identified in *S. glabrum* to those that are regularly found in other *Stereocaulon* species. The primary goal of this thesis is to start a comprehensive analysis of the secondary metabolites present in *S. glabrum*. We will isolate and characterize some of the chemical components present in this lichen by using analytical and spectroscopic methods like chromatography, NMR spectroscopy, and mass spectrometry. We anticipate that the results of this research will advance our knowledge of *Stereocaulon* genus chemical diversity and pharmacological potential, offering important insights into the identification of new leads for drug development, discovery of new natural products, and new physiologically active chemicals in the future.

**Keywords:** Secondary metabolites, *Stereocaulon glabrum*, Antarctica, lichen atranorin, lobaric acid, mass spectrometry (MS), nuclear magnetic resonance (NMR), chromatography.

**Thesis contains:** 46 pages, 46 figures, 7 tables, 1 scheme, 17 supplements, 34 references

**Original in:** English

#### Defense committee for evaluation and defense of diploma thesis:

- |    |   |                      |
|----|---|----------------------|
| 1. | Franko Burčul, PhD, Assoc. Prof.              | chair person         |
| 2. | Juan Carlos García Galindo, PhD, Assoc. Prof. | member/co-supervisor |
| 3. | Ivica Blažević, PhD, Full Prof.               | supervisor           |

#### Defense date:

**Printed and electronic (PDF) form of thesis is deposited** in Library of Faculty of Chemistry and Technology in Split, Ruđera Boškovića 35, in the public library database of the University of Split Library and in the digital academic archives and repositories of the National and University Library.



## TEMELJNA DOKUMENTACIJSKA KARTICA

DIPLOMSKI RAD

Sveučilište u Splitu  
Kemijско-tehnološki fakultet u Splitu  
Diplomski studij Kemija

**Znanstveno područje:** Prirodne znanosti  
**Znanstveno polje:** Kemija  
**Mentor:** prof. dr.sc. Ivica Blažević  
**Komentor:** izv. prof. dr. sc. Juan Carlos Garcia Gallindo

### PROUČAVANJE KEMIJSKOG SASTAVA ANTARKTIČKOG LIŠAJA *Stereocaulon glabrum*

Damjan Medaković, 171

**Sažetak:** *Stereocaulon glabrum* je vrsta u rodu *Stereocaulon*, koji je dio obitelji *Stereocaulaceae*. Ova vrsta lišajeva je dobro poznata po svojim karakterističnim obilježjima i potencijalu kao izvor značajnih sekundarnih metabolita. Razumijevanje kemijskog sastava *Stereocaulon glabruma* ključno je za istraživanje njegovih mogućih primjena u disciplinama poput farmaceutike. Rod *Stereocaulon* razlikuje se po svom kustoškom primarnom talusu i vresastom sekundarnom talusu. Ova vrsta može se pronaći kako kolonizira brojne podloge, poput stijena, tla i kore drveća, i rasprostranjena je diljem različitih geografskih područja, čime postaje dobar kandidat s obzirom na količinu za buduće primjene. Prema ranijim istraživanjima, rod *Stereocaulon* je izvor mnogih sekundarnih metabolita koji podržavaju biološke funkcije organizma, kemijske interakcije sa svojim okolišem i također ima potencijala za medicinsku primjenu. Ti metaboliti uključuju depside, depsidone, dibenzofurane i druge specifične kemijske spojeve. Gotovo svi od njih su fenolne prirode koji daju raznovrsne kemijske strukture. Karakteristični sekundarni metaboliti roda *Stereocaulon* su stičična kiselina, atranorin, lobarična kiselina i drugi fenolni spojevi. Kako bismo prepoznali sličnosti i potencijalne razlike u molekularnoj identifikaciji, usporedit ćemo spojeve koje smo identificirali u *Stereocaulon glabrumu* s onima koji se redovito nalaze u drugim vrstama roda *Stereocaulon*. Glavni cilj ovog rada je započeti sveobuhvatnu analizu sekundarnih metabolita prisutnih u *Stereocaulon glabrumu*. Izolirati ćemo i analizirati neke od različitih kemijskih komponenti koje se nalaze u ovoj vrsti lišaja koristeći analitičke i spektroskopske metode poput kromatografije, NMR spektroskopije i masene spektrometrije. Očekujemo da će rezultati ovog istraživanja unaprijediti naše znanje o kemijskoj raznolikosti roda *Stereocaulon* i farmakološkom potencijalu, pružajući važne uvide u stvaranje novih lijekova, prirodnih proizvoda i fiziološki aktivnih kemijskih spojeva u budućnosti.

**Ključne riječi:** Sekundarni metaboliti, *Stereocaulon glabrum*, Antarktika, lišaj, atranorin, lobarična kiselina, masena spektrometrija (MS), nuklearna magnetska rezonanca (NMR), kromatografija.

**Rad sadrži:** 46 stranica, 46 slika, 7 tablica, 1 shema, 17 priloga, 34 literaturnih referenci

**Jezik izvornika:** engleski

#### Sastav Povjerenstva za ocjenu i obranu diplomskog rada:

- |  |               |
|--|---------------|
| 1. izv. prof. dr. sc. Franko Burčul              | predsjednik   |
| 2. izv. prof. dr. sc. Juan Carlos García Galindo | član/komentor |
| 3. prof. dr. sc. Ivica Blažević                  | mentor        |

**Datum obrane:** 2023.

**Rad je u tiskanom i elektroničkom (PDF) obliku** pohranjen u Knjižnici Kemijско-tehnološkog fakulteta u Splitu, Ruđera Boškovića 35, u javnoj internetskoj bazi Sveučilišne knjižnice u Splitu te u javnoj internetskoj bazi diplomskih radova Nacionalne i sveučilišne knjižnice.





*Diploma thesis was made in Department of Organic Chemistry, Faculty of Science, University of Cádiz, under mentorship of professor Ivica Blažević and co-mentorship of professor Juan Carlos García Galindo, from March 2023 until July 2023.*

*I'd like to express my heartfelt gratitude to Professor Juan Carlos Garcia Galindo, my mentor at the University of Cádiz, for his constant tolerance, generosity, and crucial comments throughout my master's thesis research.*

*I'd also want to thank Professor Ivica Blažević, my mentor at Faculty of Chemistry and Technology, Split, and Dr. Sc. Azra Đulović for their help and advice during the process.*

*I am really thankful to the Organic Chemistry Department of the Faculty of Science, University of Cadiz, for allowing me to do my research and for the resources and assistance they have graciously provided.*

*In addition, I'd like to thank my colleagues in the Organic Chemistry Department for being an excellent group of people both within and outside of the laboratory, as well as for their time and willingness to share their expertise. I'd especially like to thank Pablo Macas-Bentez for his friendship and guidance during the entire endeavor.*

*Finally, I want to express my gratitude to my family and friends for their steadfast love, unending support, and understanding throughout my education.*

## DIPLOMA THESIS TASK

- Determine the best solvent system for the separation using the thin layer chromatography (TLC)
- Perform Soxhlet extraction of the sample to obtain higher quantity of mixture of secondary metabolites (extract) for later stages
- Perform the column chromatography of the extract and test the purity of fractions using with thin layer chromatography (TLC)
- Perform additional purification with high performance liquid chromatography (HPLC) for the compounds which still have impactful amount of impurities
- Characterize pure compounds using spectroscopic methods, specifically, mass spectrometry (MS) and nuclear magnetic resonance (NMR)

## ABSTRACT

*Stereocaulon glabrum* is a species of the genus *Stereocaulon*, which belongs to the Stereocaulaceae family. This lichen is known for its distinctive traits and represents a potential source of important secondary metabolites. Understanding *S. glabrum*'s chemical composition is of importance for investigating its possible applications in pharmacy to name the one. *Stereocaulon* genus is distinguished by its crustose-type primary thallus and fruticose type secondary thallus. This species colonizes numerous substrates, such as rocks, soil, and tree bark, and is distributed across various geographical regions, making it a very good candidate for future applications. According to previous studies, the genus *Stereocaulon* synthesizes a wide range of secondary metabolites that support the organism's biological functions, chemical interactions with its environment and also have potential in medicinal applications. These metabolites include depsides, depsidones, dibenzofurans, and other specific compound classes. Almost all of them are of phenolic nature displaying a diverse range of chemical structures. The typical secondary metabolites in the *Stereocaulon* genus are stictic acid, atranorin, lobaric acid, and other phenolic compounds. In order to identify similarities and potential differences in molecular identification, we will compare the compounds that we have identified in *S. glabrum* with those regularly found in other *Stereocaulon* species. The primary goal of this thesis is to perform a comprehensive analysis of the secondary metabolites present in *S. glabrum*. Some of the components present in this lichen were isolated and characterized using analytical and spectroscopic techniques such as chromatography, mass spectrometry, and NMR spectroscopy.

We anticipate that the results of this research will advance our knowledge of *Stereocaulon* genus chemical diversity and pharmacological potential, offering important insights into the identification of new leads for drug development, discovery of new natural products, and new physiologically active chemicals in the future.

**Keywords:** secondary metabolites, *Stereocaulon glabrum*, Antarctica, lichen, atranorin, lobaric acid, chromatography, mass spectrometry (MS), nuclear magnetic resonance (NMR).

## SAŽETAK

*Stereocaulon glabrum* je vrsta iz roda *Stereocaulon*, koji pripada obitelji Stereocaulaceae. Ova vrsta lišaja je dobro poznata po svojim karakterističnim obilježjima te predstavlja potencijalni izvor važnih sekundarnih metabolita. Razumijevanje kemijskog sastava *S. glabrum* ključno je za istraživanje njegove moguće primjene kao npr. u polju farmacije. Rod *Stereocaulon* razlikuje se po svom korastom (krustoznom) primarnom talusu i žbunastom (frutikoznom) sekundarnom talusu. Ova vrsta poznata po tome što kolonizira brojne podloge, poput stijena, tla i kore drveća te je rasprostranjena diljem različitih geografskih područja, što ju čini dobrim kandidatom za buduće primjene.

Prema ranijim istraživanjima, rod *Stereocaulon* je izvor mnogih sekundarnih metabolita koji podržavaju biološke funkcije organizma, kemijske interakcije sa svojim okolišem te predstavlja potencijal za medicinsku primjenu. *S. glabrum* sadrži metabolite koji uključuju: depside, depsidone, dibenzofurane i druge specifične klase spojeva. Gotovo svi od njih su fenolne prirode te se odlikuju raznovrsnim kemijskim strukturama. Karakteristični sekundarni metaboliti roda *Stereocaulon* su stiktinska kiselina, atranorin, lobarinska kiselina i drugi fenolni spojevi. Kako bismo prepoznali sličnosti i razlike u kemijskom sastavu, uspoređeni su spojevi koje smo identificirali u *S. glabrum* s onima koji se redovito nalaze u drugim vrstama roda *Stereocaulon*. Glavni cilj ovog rada je započeti sveobuhvatnu analizu sekundarnih metabolita prisutnih u *S. glabrumu*. Izolirani su i analizirani neki od različitih komponenti koje se nalaze u ovoj vrsti lišaja korištenjem analitičkih i spektroskopskih tehnika poput kromatografije, spektrometrije masa i NMR spektroskopije.

Očekuje se da će rezultati ovog istraživanja unaprijediti naše znanje o kemijskoj raznolikosti roda *Stereocaulon* i farmakološkom potencijalu u smislu otkrivanja potencijalno novih lijekova, prirodnih proizvoda i fiziološki aktivnih kemijskih spojeva u budućnosti.

**Ključne riječi:** sekundarni metaboliti, *Stereocaulon glabrum*, Antarktika, lišaj, atranorin, lobarinska kiselina, kromatografija, spektrometrija masa (MS), nuklearna magnetska rezonanca (NMR).

## Contents

INTRODUCTION.....	1
1.GENERAL PART.....	4
1.1. CHARACTERISTICS AND STRUCTURE OF GENUS <i>Stereocaulon</i> .....	4
1.2. SECONDARY METABOLITES OF STERECAULON GENUS.....	6
1.2.1. DEPSIDES.....	6
1.2.1.1. BIOLOGICAL ACTIVITY OF SOME DEPSIDES.....	7
1.2.2. DEPSIDONES.....	8
1.2.2.2. BIOLOGICAL ACTIVITY OF SOME DEPSIDONES.....	8
1.2.3. DIPHENYLEETHERS.....	9
1.2.3.3. BIOLOGICAL ACTIVITY OF SOME DIPHENYLEETHERS.....	9
1.2.4. DIBENZOFURANS.....	10
1.2.4.1. BIOLOGICAL ACTIVITY OF SOME DIBENZOFURANS.....	10
1.2.5. MONOAROMATIC PHENOLS.....	10
1.2.5.1. BIOLOGICAL ACTIVITY OF SOME MONOAROMATIC PHENOLS.....	11
1.2.6. ANTRAQUINONES.....	11
1.2.6.1. BIOLOGICAL ACTIVITY OF SOME ANTRAQUINONES.....	12
1.2.7. TERPENOIDS.....	13
1.2.7.1. BIOLOGICAL ACTIVITY OF SOME TERPENOIDS.....	13
1.2.7.2. BIOLOGICAL ACTIVITIES OF SOME STEROIDS.....	15
1.2.8. POLYOLS.....	15
1.2.8.1. BIOLOGICAL ACTIVITIES OF SOME POLYOLS.....	16
2. EXPERIMENTAL SECTION.....	17
2.1. MATERIALS AND METHODS.....	17
2.1.1. INSTRUMENTAL TECHNIQUES.....	17
2.1.2. CHROMATOGRAPHIC TECHNIQUES.....	18
2.1.3. EXTRACTION TECHNIQUES.....	19
2.1.4. SOLVENTS AND DEVELOPERS.....	19
2.1.5. LICHEN MATERIAL.....	20
2.2. EXPERIMENTAL PART: SEPARATION TECHNIQUES.....	21
2.2.1. SOXHLET EXTRACTION AND SAMPLE PREPARATION.....	21
2.2.2. PRELIMINARY TLC STUDIES.....	22
2.2.3. STUDY OF THE HEXANE AND ACETONE EXTRACTS.....	24
2.2.4. STUDY OF THE F <sub>3</sub> FRACTION.....	26
2.2.5. STUDY OF THE F <sub>3.2</sub> AND F <sub>3.3</sub> FRACTION.....	27
2.2.6. STUDY OF THE F <sub>5</sub> , F <sub>6</sub> AND F <sub>3.5</sub> FRACTIONS.....	27
2.2.7. THE SUMMARY OF ALL CC SEPARATIONS.....	28
2.2.8. HPLC PURIFICATIONS.....	29
2.3. IDENTIFICATION AND CHARACTERIZATION OF COMPOUNDS.....	32
2.3.1. NMR AND MS: SELECTION AND PREPARATION OF SAMPLES.....	32

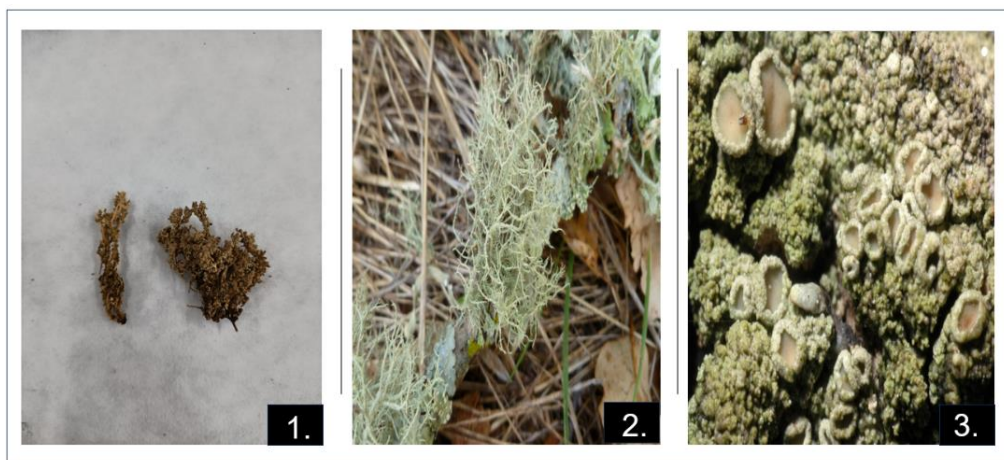
2.3.2. RESULTS .....	33
3. CONCLUSIONS .....	45
4. ABBREVIATIONS .....	47
5. BIBLIOGRAPHY .....	48
6. SUPPLEMENTARY/ANNEX .....	53



## INTRODUCTION

A lichen is a symbiotic organism formed by two major distinct partners: fungi (mycobiont) and/or algae/cyanobacteria as photobiont. Furthermore, the photobiont's primary role is photosynthesis, which provides food for the fungi, whereas the mycobiont is in charge of providing the shelter and absorbing water and nutrients for the algae/cyanobacteria. Even though these two partners form a symbiotic relationship, the chemical composition of lichens is completely different from the secondary metabolite profile when they are separated. They are also interesting subjects of research because of the distinctive structure of their secondary metabolites and their potential therapeutic uses, such as antioxidant, antimicrobial, antifungal, anticancer, among many others.<sup>1,2</sup>

*Stereocaulon* is an interesting candidate among many lichen genera, which has a rich supply of secondary metabolites with medicinal potential. Lichens are classified into three types of growth forms depending on their physical appearance and structure: fruticose (1), foliose (2) and crustose (3). Crustose lichens take the form of a tightly adherent crust or coating on their substrate, which can be rocks, soil, or tree bark. Foliose lichens have a leafy form and can be adhered to their substrate loosely. In terms of growth morphology, fruticose lichens are the most complex. They look like little branches or twigs and are shrub-like. Each variety exhibits unique structural traits and environmental adaptations, which are further addressed in the next section.<sup>5</sup>



**Figure 1.** Growth forms – 1. fruticose (*S. glabrum*), 2. foliose (*Usnea spp.*)<sup>3</sup>, 3. crustose (*Lecanora conizaeoides*)<sup>4</sup>

*S. glabrum* is a fruticose-type lichen which has a structure similar to a small shrub and is distinguished from other types of growth by the presence of particular organs such as pseudopodetia, phyllocladia, cephalodia, and apothecia.<sup>1</sup> In the section that follows, these organs will be described in more detail. The origin of our *S. glabrum* samples is from the Paradise Bay in Antarctica.

Lichens are also incredibly durable and can endure extreme environmental circumstances for extended periods of time when in a dormant state. They are also capable of re-starting their metabolic activity once favorable environmental conditions arise, even after a lengthy period of time. Extreme conditions like the Arctic, Antarctica, and high-altitude mountains make this particularly obvious. When lichens in the Arctic and Antarctic regions are buried in ice and snow throughout the winter, they typically go dormant. When the ice and snow melt and they are once again exposed to light, their metabolic activity resumes. Lichens adjust their pace of growth based on the water and resource availability. This is particularly clear in the lichens that thrive in the dry valleys of Antarctica, where precipitation is extremely sparse and it can go for years without snowing or raining. In these valleys, certain lichens develop at a rate of roughly 0.001 millimeters per year. Since they grow so slow, a 3 cm wide lichen counts as an organism older than 3000 years, making lichens among of the oldest living organisms on Earth.<sup>6</sup>

*S. glabrum*, is believed to be a source of numerous secondary metabolites of phenolic nature belonging to different structural families, including depsides, depsidones, diphenylethers, dibenzofurans, but also, terpenes and steroids among many others. These skeletons are typical of the *Stereaulon* genus. Secondary metabolites are believed to play a role in the defense of the lichen against other organisms (bacteria, other lichens, rodents) and against environmental stressors like Reactive Oxygen Species (ROS) such as peroxides or superoxides formed under oxidative stress conditions (e.g. intense UV light). As a consequence, many of these compounds exhibit interesting therapeutic potential, such as the antibacterial and antimicrobial properties of *Stereaulon*

*vulcani* and the antidiabetic and cytotoxic properties of *Stereaulon pascale*, among others.<sup>5</sup>

*S. glabrum*, the species that is the objective of this master thesis, was collected on Antarctica in January 2007 as part of the expedition conducted during the period of 2006-2007. In order to successfully isolate pure secondary metabolites from *S. glabrum*, the methodology involved extraction and different chromatographic techniques: column chromatography (CC) and high performance liquid chromatography (HPLC). The chemical structures of the isolated metabolites were elucidated by mass spectrometry (MS) and nuclear magnetic resonance (NMR). HPLC was used when CC was not enough to separate the compounds with the adequate level of purity to undertake the MS and NMR study. As a result of this thesis several already known compounds were isolated and identified, along with a novel compound that is still in the process of elucidation of its chemical structure. These results will contribute to the general knowledge of the *Stereaulon* species as a whole. To our knowledge, and based on the data found in the literature, this is the first study on the chemical composition of *S. glabrum*.

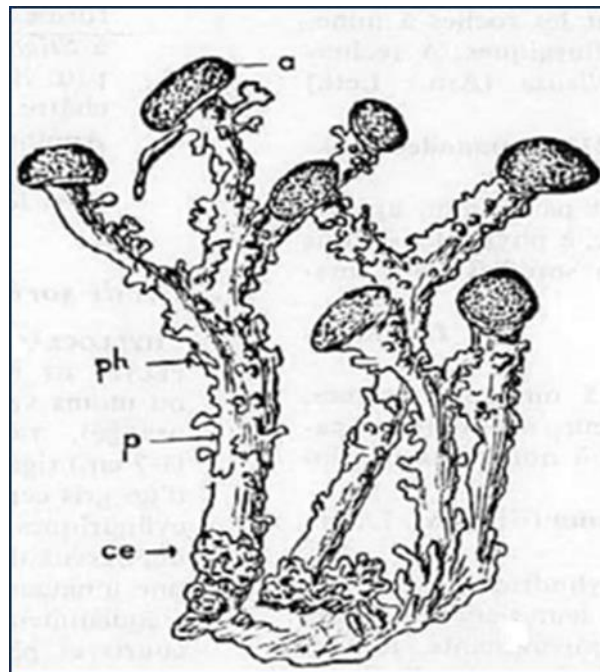
## 1. GENERAL PART

### 1.1. CHARACTERISTICS AND STRUCTURE OF GENUS

#### *Stereocaulon*

*Stereocaulon glabrum*, belongs to family Stereocaulaceae. The genus *Stereocaulon* currently contains approximately 130 species that are found all over the world. They can be found in a variety of ecosystems, from temperate to alpine. They flourish in a variety of environmental circumstances, including low temperatures, high UV radiation levels, and nutritional scarcity. They can also be used to monitor environmental factors such as air quality and pollution levels due to their capacity to sequester heavy metals and other pollutants.

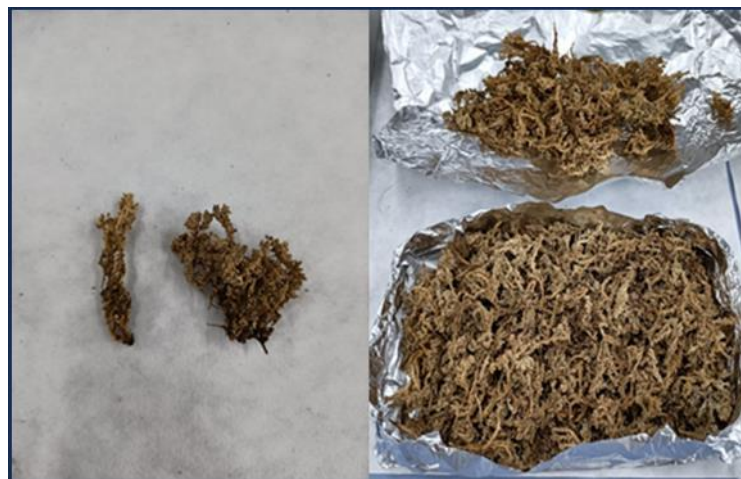
Regarding their physiology, in the *Stereocaulon* species the following organs are normally present: pseudopodetia (p), phyllocladia (ph), cephalodia (ce), and apothecia (a) (Figure 2).<sup>5,6</sup>



**Figure 2.** General morphology of *Stereocaulon* genus<sup>5</sup>

The *Stereocaulon* genus has two types of thallus, the crustose, primary type and fruticose, secondary type. The term "thallus" in biology refers to the vegetative body or structure of certain organisms, notably those lacking genuine roots, stems, or leaves. Crustose thalluses are drought resistant and well adapted

to dry conditions; they resemble a crust that is firmly glued to a surface. Fruticose (stalked) thallus and filamentous forms appears like small, branching, and bushy structures growing on rocks, trees and variety of surfaces like exposed or nutrient poor substrates. Both growth forms can be found in Artic and Antartic regions. Pseudopodetia are specialized growth forms of lichens that resemble stalks or branches. Phyllocladia are specialized flattened or leaf-like stems that operate as photosynthetic organs in certain plants and execute the respiration (obtaining energy by breaking down organic molecules) and assimilation (transformation of inorganic compounds in organic compounds, process: photosynthesis) functions of a leaf. Their phyllocladia can have a variety of morphologies, ranging from granular to peltate, digitate even coralloid, papillose, with phyllocladioid branchlets.<sup>5</sup> Branchlets on *S. glabrum* are phyllocladioid (Figure 3).

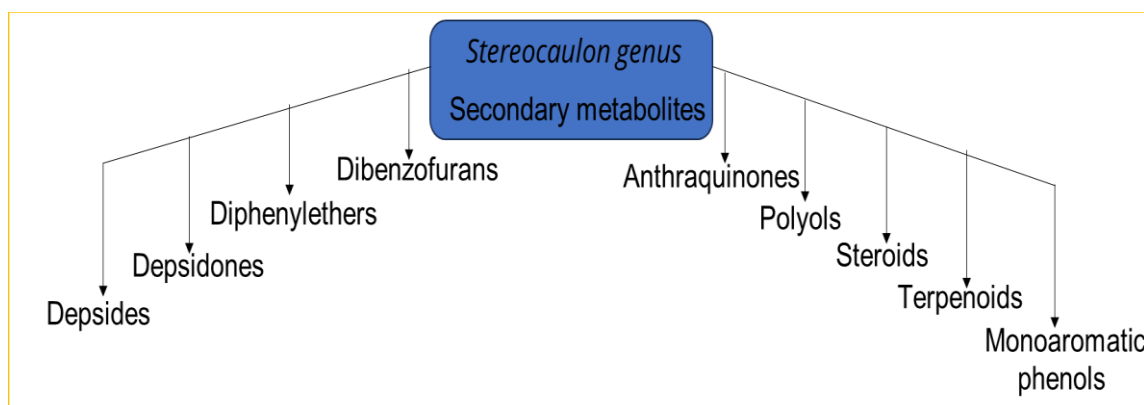


**Figure 3.** Phyllocladioid branchlets of *Stereocaulon glabrum*

The apothecia, which is a reproductive structure that houses spores, is one of most significant organs found in the secondary thallus. The terminal or lateral apothecia position has a convex or nearly spherical disc form, and its hue ranges from light brown to dark brown. Other organ is cephalodium which contains a secondary photobiont from a cyanobacteria (*Nostoc*, *Rhizonema*, or *Stigonema*) and is used for nitrogen fixation. Nitrogen fixation is a biological and chemical process that converts atmospheric nitrogen ( $N_2$ ) into a form that living organisms can utilise.<sup>5</sup>

## 1.2. SECONDARY METABOLITES OF STEREOCAULON GENUS

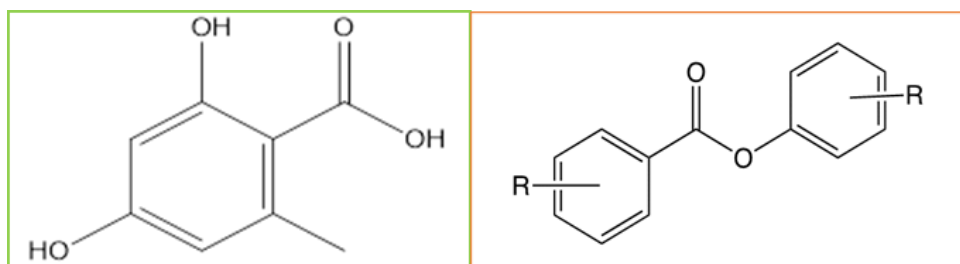
Major secondary metabolites isolated from *Stereocaulon* species mostly consist of depsides, depsidones, diphenylethers, dibenzofurans, monoaromatic phenols, terpenoids, steroids, anthraquinones and polyols (Figure 4), most of them being of a phenolic nature.<sup>5</sup>



**Figure 4.** Overview of secondary metabolites of the *Stereocaulon* genus

### 1.2.1. DEPSIDES

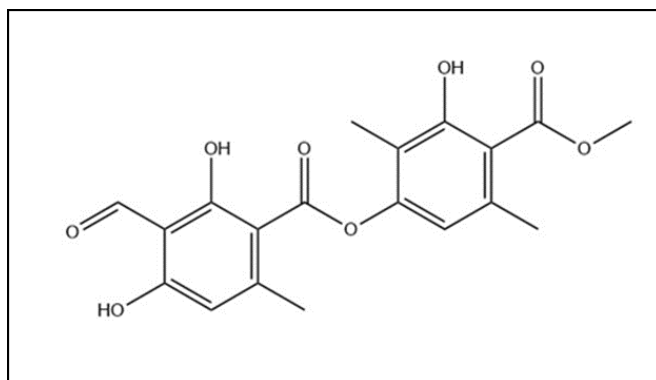
Depsides are simple polyketides generated by the ester linkage of two or more hydroxybenzoic acid moieties, the -COOH group of one molecule is esterified with a hydroxyl group on the benzene ring of the second molecule. In other words, a lot of structures consist of two aromatic rings linked by an ester bond. They can be  $\beta$ -orsellinic acid or orsellinic acid relying on the existence of the C<sub>3</sub> methyl group on both rings. As a result, orsellinic acid can be regarded as the building block of all depsides (Figure 5).<sup>5, 7</sup>



**Figure 5.** Structure of orsellinic acid (left) and general structure of depsides (right)

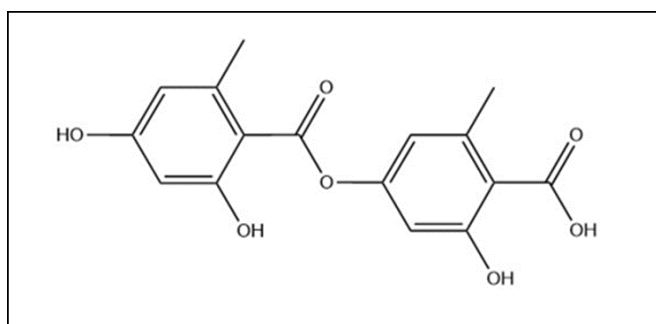
### 1.2.1.1. BIOLOGICAL ACTIVITY OF SOME DEPSIDES

Nearly all species of the genus *Stereocaulon* contain atranorin (Figure 6), one of the most prevalent and well-known depsides. Atranorin has the potential to operate as a cytotoxic, antibacterial, antitumor and anti-inflammatory agent, according to a review of numerous research publications,<sup>5, 8, 9, 10, 11,</sup> or even in depression treatment.<sup>12</sup>



**Figure 6.** Atranorin

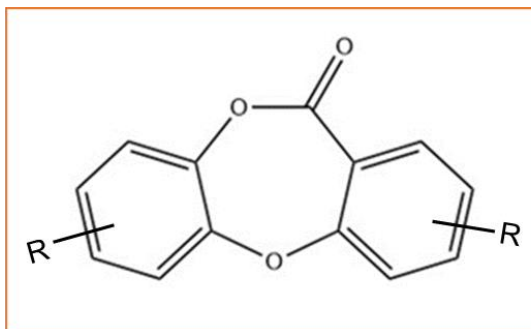
Another common depside in genus *Stereocaulon* is lecanoric acid, found in *Stereocaulon curtam* and *Stereocaulon corticulatum*, (Figure 7). Lecanoric acid does not have the acid moiety esterified, like atranorin, and appears as a free acid. Lecanoric acid exhibits antioxidant and antimicrobial properties.<sup>5, 11</sup>



**Figure 7.** Lecanoric acid

## 1.2.2. DEPSIDONES

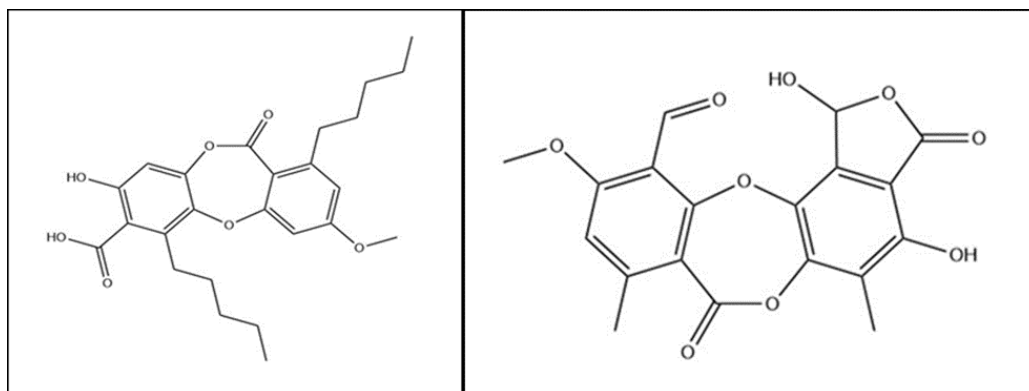
Depsidones are aromatic compounds formed by two 2,4-dihydroxybenzoic acid rings joined by ether and ester bonds (Figure 8). Their rings are based on the structure of orsellinic acid.<sup>5, 13</sup>



**Figure 8.** General structure of depsidone

### 1.2.2.2. BIOLOGICAL ACTIVITY OF SOME DEPSIDONES

Some examples of depsidones are colensoic and stictic acid (Figure 9). Colensoic acid, found in *Stereocaulon colensoi*, has shown significant potential as an anti-inflammatory and antioxidant.<sup>5,14,15</sup> One interesting application is its potential neuroprotective properties, which may safeguard human health by halting the death of nerve cells.<sup>14</sup> Stictic acid, found in *Stereocaulon vulcani*, exhibits antimicrobial and antioxidant properties.<sup>5</sup>

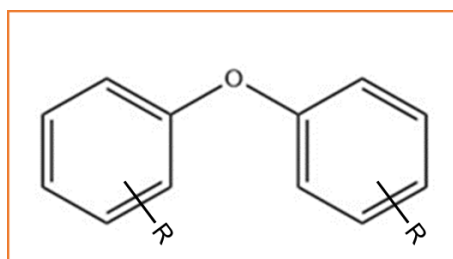


**Figure 9.** Colensoic acid (left), stictic acid (right)



### 1.2.3. DIPHENYLEETHERS

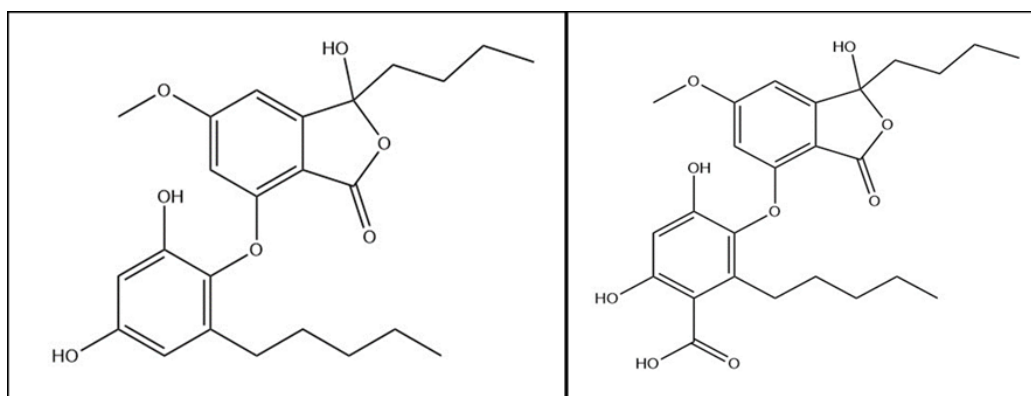
Diphenylethers, also known as pseudodepsidones, present two phenyl (aryl) groups linked by an oxygen atom (Figure 10).<sup>5</sup> Like in the previously described classes of compounds, at least one of the moieties is a derivative of orsellinic acid.



**Figure 10.** General structure of diphenylether

#### 1.2.3.3. BIOLOGICAL ACTIVITY OF SOME DIPHENYLEETHERS

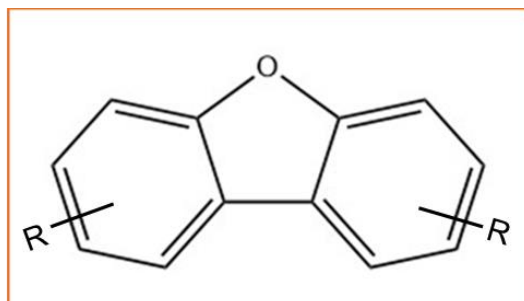
Sakisacaulon A and lobarin (Figure 11) are two examples of diphenylethers found in *Stereocaulon* species. While specific biological qualities of sakisacaulon A, found in *Stereocaulon sasakii*, were not discovered, at least not by our research through research publications, lobarin, found in *Stereocaulon halei*, displayed antioxidant effects and may be exploited as a therapeutic candidate for diseases such as diabetes or obesity.<sup>5, 16, 17</sup>



**Figure 11.** Sakisacaulon A (left), lobarin (right)

## 1.2.4. DIBENZOFURANS

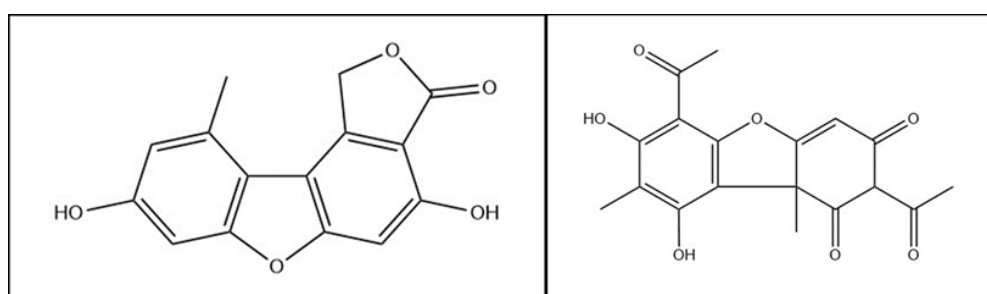
Two benzene rings are fused to a central furan ring to form the dibenzofuran backbone (Figure 12).<sup>5, 18</sup>



**Figure 12.** General structure of dibenzofuran

### 1.2.4.1. BIOLOGICAL ACTIVITY OF SOME DIBENZOFURANS

Strepsilin which can be found in *Stereocaulon azureum*, and the widely distributed usnic acid which can be found in *Cladonia arbuscula* and *Usnea spp.* are some examples of dibenzofurans (Figure 13).<sup>5, 15</sup> The biological activity of usnic acid has been widely explored and reports about its potential use covers a wide range, from pesticide, to anticancer, antioxidant and antimicrobial agents.<sup>8,11</sup>



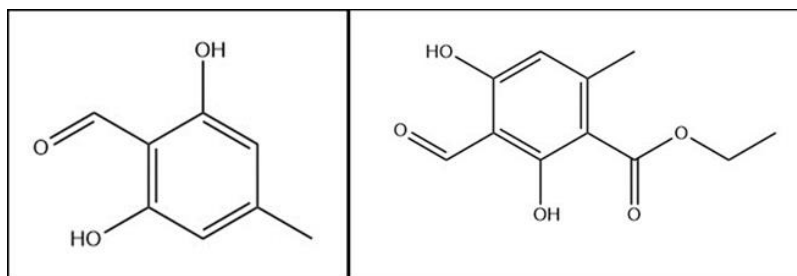
**Figure 13.** Strepsilin (left), usnic acid (right)

## 1.2.5. MONOAROMATIC PHENOLS

Monoaromatic phenolic compounds are a common and usually abundant group of secondary lichen metabolites that are also found in *Stereocaulon* species. They are chemical compounds made up of a single aromatic ring bearing to a hydroxyl (-OH) group.<sup>5</sup>

### 1.2.5.1. BIOLOGICAL ACTIVITY OF SOME MONOAROMATIC PHENOLS

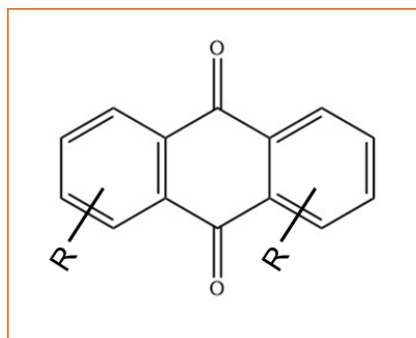
Some examples of common monoaromatic phenols are atranol and ethyl haematomate (Figure 14). Atranol, can be found, for example, in *Stereocaulon vesuvianum*. It has demonstrated to have antibacterial activity as well as antioxidant potential. Ethyl haematomate, that has been described in, e.g., *Stereocaulon paschale* among many other *Stereocaulon* species exhibits antioxidant activity.<sup>5, 19, 20, 21</sup>



**Figure 14.** Atranol (left), ethyl haematomate (right)

### 1.2.6. ANTRAQUINONES

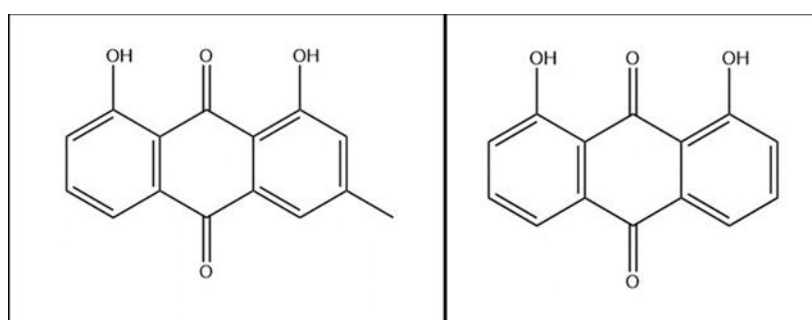
Antraquinones are a widely distributed type of secondary metabolites that can be found in lichens, but also in plants and fungi or bacteria. They are derived from the acetate-mevalonate biosynthetic pathway and their backbone corresponds to that of anthracene, a polycyclic aromatic hydrocarbon comprised of three fused benzene rings and two keto groups (Figure 15). Even though most of the 700 antraquinones described as secondary metabolites can be found in lichens<sup>22</sup>, their presence in the *Stereocaulon* genus is very scarce.<sup>5</sup>



**Figure 15.** General structure of anthraquinones

### 1.2.6.1. BIOLOGICAL ACTIVITY OF SOME ANTRAQUINONES

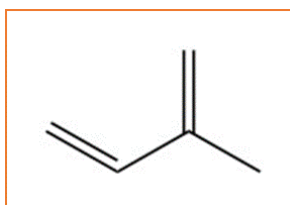
Due to their chemical structure, anthraquinones play a role in the electron transport chain in the primary metabolism in plants, but also in the secondary metabolism as defense compounds due to their wide array of biological activities, which include antioxidant, antibacterial, antifungal, or anticancer among many others.<sup>22</sup> While most of the reports published refer to the biological activity of typical lichen secondary metabolites previously described, no reports on specific lichen anthraquinones could be found. To illustrate anthraquinones, we used chrysophanol, which was isolated from *Aloe excelsa*, and danthron, which was isolated from a type the marine fungus *Chromolaenicola* (Figure 16). While danthron has the potential to increase the effectiveness of several antioxidant and anticancer agents in the treatment of cancer, chrysophanol has antibacterial potential.<sup>23, 24, 25</sup>



**Figure 16.** Chrysophanol (left), danthron (right)

## 1.2.7. TERPENOIDS

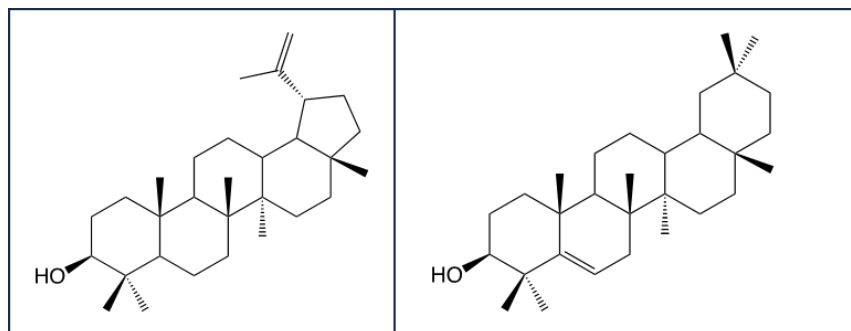
Terpenoids, also known as isoprenoids, are a wide and diversified class of natural chemical compounds formed by the combination of isoprene ( $C_5H_8$ ) units (Figure 17). Based on the isoprene unit as a building block, terpenoids are one of the most numerous groups of secondary metabolites in plants, bacteria and fungi. Depending on the number of isoprene units they possess, terpenoids can be classified in monoterpenes ( $C_{10}$ , two isoprene units), sesquiterpenes ( $C_{15}$ , three isoprene units), diterpenes ( $C_{20}$ , four isoprene units), sesterterpenes ( $C_{25}$ , five isoprene units), and triterpenes and steroids ( $C_{30}$ , six isoprene units). The combination of isoprene units gives rise to an enormous variety of structures, which range out of the scope of this work. However, references to the isolation of terpenes in lichens are scarce, being all of them triterpenes or steroids. In the genus *Stereocaulon* there are reports of steroids from *Stereocaulon azureum* and *Stereocaulon tomentosum* such as ergosterol peroxide, cerevisterol and brassicasterol, and some few triterpenes from *S. azureum*:  $\alpha$ -amyrin, lupeol and taraxerol.<sup>5, 26</sup>



**Figure 17.** Isoprene unit

### 1.2.7.1. BIOLOGICAL ACTIVITY OF SOME TERPENOIDS

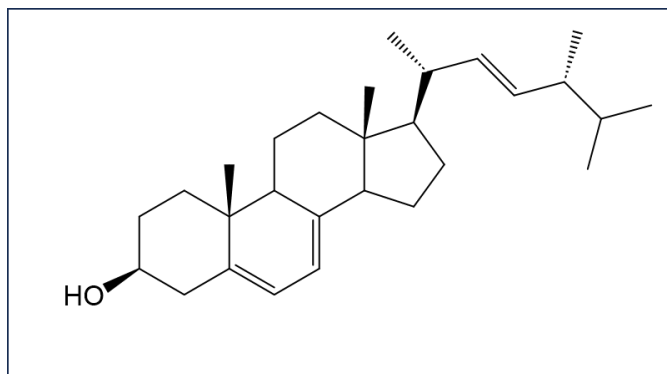
Terpenoids include compounds like lupeol and taraxerol (Figure 18), which are both present in *S. azureum*.<sup>5</sup> While taraxerol may have antioxidative and antimicrobial characteristics, lupeol exhibits an anti-inflammatory, anticancer, and antioxidant activities.<sup>5, 27, 28</sup>



**Figure 18.** *Lupeol (left), taraxerol (right)*

### 1.2.7.2. BIOLOGICAL ACTIVITIES OF SOME STEROIDS

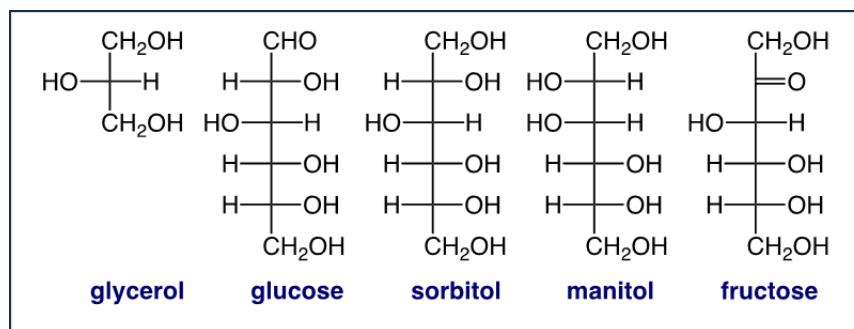
Steroids are compounds widely used in medicine for multiple purposes. Regarding the steroids isolated from the *Stereocaulon* genus, ergosterol (Figure 19), isolated from the *S. tomentosum* presents prospective applications as an antioxidant and an antidiabetic drug.<sup>5, 29, 30</sup>



**Figure 19.** Ergosterol

### 1.2.8. POLYOLS

Polyols, also called sugar alcohols, are hydrogenated forms of carbohydrates in which the carboxyl group of either an aldehyde or a ketone has been reduced to a primary or secondary hydroxyl group, thus making the compound an alcohol.<sup>31</sup> Common polyols widely present in many plant, lichen and insect species are glycerol, sorbitol, or mannitol. Sorbitol can be considered the reduced form of glucose, while mannitol could derive either from glucose or fructose (Figure 20). In lichens, most common polyols are those formed of four (tetrytols) and five (pentitols) carbon atoms. Erythritol (four carbons) is one of the most abundant polyols in lichens, but six carbon polyols such as mannitol can be also found (e.g., in *S. colonsei*).<sup>5</sup>

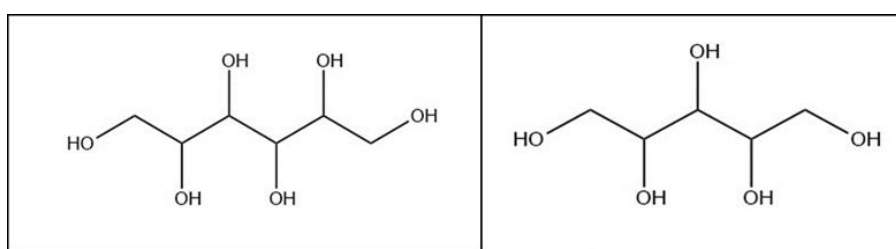


**Figure 20.** Common polyols found in plant, lichen and insect species

### 1.2.8.1. BIOLOGICAL ACTIVITIES OF SOME POLYOLS

As previously mentioned, polyols are present in many species of insects, plants, and fungi.<sup>26</sup> The ability of concentrated sugar and polyols solutions to lower the freezing point of water has made of them natural anti-freezers to protect insects (glycerol) or plants (mannitol, sorbitol) from low-temperature conditions. In lichens, they have been suggested to play a key role in anhydrobiosis, the capacity to survive desiccation. This is of key importance as it will be one of the key factors explaining the resilience of lichens under extreme conditions, such as low temperature or drought, and has been related as an evolutionary advantage.<sup>32</sup>

Regarding other possible biological activities xylitol may have antimicrobial and hypoglycemic properties.<sup>31, 33</sup>



**Figure 21.** Mannitol (left), xylitol (right)



## 2. EXPERIMENTAL SECTION

### 2.1. MATERIALS AND METHODS

#### 2.1.1. INSTRUMENTAL TECHNIQUES

##### *Nuclear Magnetic Resonance (NMR)*

NMR experiments were conducted in a Bruker Avance Neo 400 MHz (Figure 22) and 500 MHz equipment.  $^1\text{H}$  and  $^{13}\text{C}$  spectra were recorded in  $\text{CDCl}_3$ . Coupling constants ( $J$ ) are measured in hertz (Hz), and chemical shifts are expressed in parts per million (ppm). The residual peak of  $\text{CHCl}_3$  was used as a reference in  $^1\text{H}$  (7,26 ppm) and  $^{13}\text{C}$  (77 ppm). The acronyms br (broad), s (single), d (doublet), t (triplet), q (quartet), m (multiplet), dd (doublet of doublet), dt (triplet of doublet), ddd (triplet of doublet of doublet), etc. are used to indicate multiplicity of signals. The multiplet is defined by the value at their midpoint.



**Figure 22.** Bruker Avance Neo 400 MHz NMR

##### *Mass spectroscopy (MS)*

Mass spectra were recorded in a Waters Synapt G2 QTOF equipped with a UPLC (ESI-APCI)/(GC(APCGI) system. Pure samples were dissolved in MeOH for injection.

## 2.1.2. CHROMATOGRAPHIC TECHNIQUES

### ***Thin- Layer Chromatography (TLC)***

Merck Kieselgel 60 F254 plates with a 0.25 mm thickness and a fluorescent indicator were used for TLC testing. UV light (254 nm and 360 nm), and a chemical staining agents were used to observe the elution of compounds on the plates. Two different chemical staining agents were used: a) *oleum*: a solution of 80 mL acetic acid (AcOH), 16 mL H<sub>2</sub>SO<sub>4</sub> and 4 mL of H<sub>2</sub>O; b) *anisaldehyde*: a solution of anisaldehyde (25 mL), ethanol (75 mL), concentrated sulfuric acid (1 mL), and acetic acid (5 mL). The plate was then heated for a short time at 100 °C in each instance until colors developed. Eluent ratios are stated as a percentage of the component with the highest polarity.

### ***Column Chromatography***

Merck silica gel with a particle size of 60-200 microns was utilized for atmospheric pressure columns. The mixtures to be separated were pre-adsorbed onto silica gel.

### ***High Performance Liquid Chromatography (HPLC)***

HPLC separations were carried out in a Merck-Hitachi L-7100 apparatus equipped with a quaternary pump and a refractive index detector Merck-Hitachi L-4000 (Figure 23). A LiChrospher Si-60 silica gel column with 10 μm, 1 × 25 cm packing (semi-preparative) was used for separations. Flow rate was set to a 1 mL/min. Samples were checked for base line by TLC with the same solvent system that will be used for HPLC. Hexane; ethyl acetate combinations were used as eluents. Solvents were HPLC-grade and were degasified using an ultrasound bath prior to use.



**Figure 23.** HPLC equipment

### **2.1.3. EXTRACTION TECHNIQUES**

#### ***Soxhlet extraction***

Extraction of secondary metabolites was carried out in a Soxhlet apparatus equipped with a 100 mL round bottom flask, a 50 mL Soxhlet extractor and a condenser. 5 Soxhlet extractions were set in parallel on a heater plate. Solvents of increasing polarity (hexane, acetone, isopropanol) of HPLC-grade were used for extraction. Temperature was set in the plate to 150 °C (hexane, acetone) and 250 °C (isopropanol).

### **2.1.4. SOLVENTS AND DEVELOPERS**

#### ***Solvents used for Chromatographies (Column, HPLC, TLC)***

HPLC-grade solvents were used for chromatography, specifically hexane (Hex), ethyl acetate (AcOEt), acetone (Ace) and methanol.

#### ***Developers and mobile phases used for Thin-layer chromatographies (TLC)***

TLC analysis was performed using two different developers: oleum and anisaldehyde. TLC was used for setting up the best solvent system for CC or HPLC, for following-up the separation in the CC and HPLC, and for checking purity of samples. Different mixtures of hexane, ethyl acetate, acetone, and methanol were checked for best results. A mixture of sulfuric acid:acetic

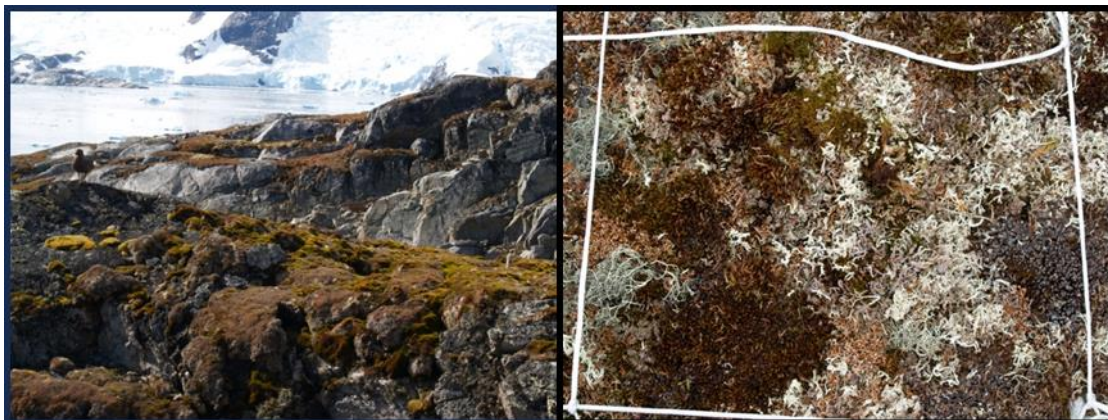
acid:water 4:80:16 (*oleum*) was used to burn the TLC plates after developing them and checking them under the UV lamp (254 nm, 360 nm).

### ***Solvents used for Soxhlet extraction***

HPLC-grade solvents of increasing polarity – hexane, acetone, and isopropanol were used sequentially.

## **2.1.5. LICHEN MATERIAL**

Samples of *Stereocaulon glabrum* were collected in Paradise Bay (Caleta Cierva) on Antarctic Peninsula. The collecting place was Highlander Point (64° 09' 00" S, 60° 53' 00" W) on 25<sup>th</sup> of January 2007 by Dr. sc. Juan Carlos García Galindo. *S. glabrum* can be found in patches in the snow-free cliffs facing the bay, far from the intertidal zones and in grounds about 10-30 m over the sea level. *S. glabrum* grows mixed with other lichen species and mosses (Figure 24). The lichen was stored in paper bags and kept in dark, at constant temperature of 15°C and dry for 15 years.



**Figure 24.** Left: sampling location at Caleta Cierva (Paradise Bay); right: patch of *S. glabrum* growing along with other *Stereocaulon*, lichen species and mosses. (Photo: © Juan Carlos García Galindo)

## 2.2. EXPERIMENTAL PART: SEPARATION TECHNIQUES

### 2.2.1. SOXHLET EXTRACTION AND SAMPLE PREPARATION

Lichen (27,3317 g) were finely cut into small pieces and divided into five parts that were introduced into small packets made with filter paper. Each sub-sample was introduced in a Soxhlet apparatus that was set up on a heating plate. The system consisted of a 100 mL round bottom flask, a Soxhlet apparatus and a condenser at the top. All five Soxhlet systems were connected sequentially as shown in Figure 25. The round bottom flasks were filled with 60 mL of solvent and covered with aluminium foil for better heating. The extraction procedure consisted of 15 cycles of extraction for each solvent. A cycle is defined as follows: the solvent is heated to reflux and the vapour travels up through the distillation arm and condenses in the condenser; the solvent drips down over the extraction chamber containing the package with the sample; when the chamber is almost filled it is emptied through the syphon, and returns to the distillation round bottom flask, completing then a cycle.

The extraction was performed by three consecutive extractions with solvents of increasing polarity: hexane, acetone, and isopropanol. Once the fifteen cycles with one solvent were completed all solvents were combined in a 500 mL round bottom flask. Then, the 100 mL round bottom flasks of the Soxhlet system were filled up with another 60 mL of the following solvent. For each solvent – hexane, acetone, and isopropanol, the combined extracts obtained from the five Soxhlet apparatus were evaporated in a rotary evaporator (Figure 25).



**Figure 25.** Soxhlet extraction system of *S. glabrum* (left), rotary evaporator (right)

Before evaporation of the hexane extract a significant amount of white crystals were formed (Figure 26). Crystals were separated from the hexane extract and recrystallized from hot hexane, and then left to crystalize in the fridge for 24 h. The crystals were washed with cold hexane and all the supernatants and washing liquids were added to the hexane extract. White crystals were then stored until analysis and labelled as compound SG<sub>1</sub>.



**Figure 26.** Crystalline formation in hexane extract, SG<sub>1</sub> crystals

The results of the extraction are summarized in Table 1. The extracts will be subjected to Column Chromatography (CC) separation to isolate the major compounds present.

**Table 1.** Weights obtained for the different extracts.

	SG <sub>1</sub> (white crystals)	Hexane	Acetone	Isopropanol
Weight (mg)	116	128,1	440,3	1204,8

### 2.2.2. PRELIMINARY TLC STUDIES

Prior to the isolation of the compounds it is necessary to optimize the separation conditions. Consequently, a preliminary study using TLC was addressed to determine the best solvent system for each extract. Previous studies (data not shown) showed that the best separations were obtained using mixtures of hexane:acetone and mixtures of hexane:ethyl acetate. Accordingly, a set of TLC experiments were run with both solvent systems and different polarities. The TLC experiments were run with samples obtained in the previous year by Soxhlet extraction and ultrasound extraction. Accordingly, samples are

named with the name of the extract and the technique used for extraction: HS, hexane Soxhlet extraction; HexU: hexane ultrasound; AceS: acetone Soxhlet; AceU: acetone ultrasound; iPrOHS: isopropanol Soxhlet; iPrOHU: isopropanol ultrasound. The solvent systems were set as follows:

- Hexane:ethyl acetate: mixtures of hexane with a 10%, 20%, 40%, 60% and 100% of ethyl acetate
- Hexane:acetone: mixtures of hexane with a 5%, 10%, 20% and 50% of acetone

Comparison of the results of the TLC analysis (Figure 27) lead to two main conclusions:

- The composition of the hexane and acetone extracts is similar
- The solvent system that provided a better separation was hexane:ethyl acetate



**Figure 27.** TLC plates of the solvent systems, a) hexane/ethyl acetate, b) hexane/acetone. HexS: hexane Soxhlet; HexU: hexane ultrasound; AceS: acetone Soxhlet; AceU: acetone ultrasound; iPrOHS: isopropanol Soxhlet; iPrOHU: isopropanol ultrasound

### 2.2.3. STUDY OF THE HEXANE AND ACETONE EXTRACTS

In view of the similarity observed between the composition of the hexane and acetone extracts it was decided to combine both in a single sample that was then subjected to Column Chromatography (CC). The total weight of the combined sample was of 568,4 mg.

The CC was prepared as follows: the sample was dissolved in the minimum amount of  $\text{CHCl}_3$  in a round bottom flask; then silica gel was added until a thick mixture was obtained. The solvent was then evaporated in the rotary evaporator and the sample was absorbed on the silica gel. A glass column fitted with a valve in the bottom was filled with silica gel trying to deposit it homogenously. Then, the silica gel with the extract absorbed was carefully deposited in the upper part and covered with more silica gel (Figure 28).



**Figure 28.** *The column chromatography system*

Once the column was set up a series of increasing polarity mixtures of hexane:ethyl acetate was added: 10%, 15%, and 20% –1 L each–; followed by 40% and 60% –0.5 L each–. Finally, the column was washed by adding first 250

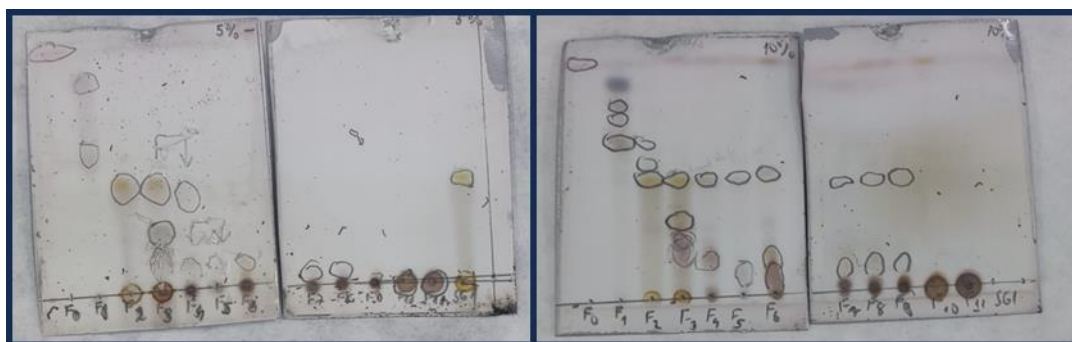


mL of ethyl acetate and 250 mL of methanol. A total number of 101 aliquots of 25 mL were collected and their composition tested by TLC using as mobile phase the same mixture that was used in the CC at the time that each aliquot was obtained.

The results of the TLC allowed to group the aliquots into eleven fractions F<sub>1</sub>-F<sub>11</sub> (Figure 29), plus the crystal fraction SG<sub>1</sub>. Hexane:ethyl acetate 5% and 10% was used for all fractions, and 20%, 40% and 60% were used for the more polar fractions F<sub>4</sub>-F<sub>11</sub>. Weights of the different fractions are shown in Table 2.

**Table 2.** Masses of fractions F1-F11 obtained for the first CC.

	F1	F2	F3	F4	F5	F6
Weight (mg)	20.0	50.1	14.5	13.3	8.6	38.7
	F7	F8	F9	F10	F11	
Weight (mg)	17.2	26.4	16.0	145.73	165.1	



**Figure 29.** TLC plates of the first column chromatography with 5% and 10% hexane:ethyl acetate

The TLC results clearly show that F<sub>2</sub> (50,1 mg) is SG<sub>1</sub> almost pure. Consequently, SG<sub>1</sub> was recrystallized from F<sub>2</sub> fraction using hot hexane followed by controlled cooling in the fridge. SG<sub>1</sub> crystallized again in white needles as it has been described previously. The amount obtained was of 13,1 mg. The washing liquids were added to F<sub>3</sub> fraction.

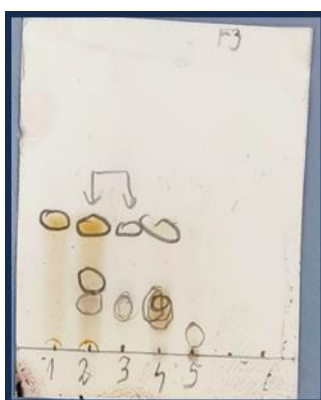
#### 2.2.4. STUDY OF THE F<sub>3</sub> FRACTION

TLC analysis of F<sub>3</sub> (145 mg) showed three major compounds (Figure 30), one of them with the same R<sub>f</sub> as SG<sub>1</sub>. Best solvent conditions for separation were set to hexane:ethyl acetate 5% according to TLC previous results.

When preparing the fraction for CC, white crystals appear. Consequently, they were set apart and washed with cold hexane as previously described. The amount obtained of SG<sub>1</sub> from F<sub>3</sub> fraction was of 40 mg. The washing liquids and the rest of the fraction were prepared for CC and eluted with hexane:ethyl acetate 5% (1L), 10% (0.5L), 100 % ethyl acetate (250 mL) and methanol (250 mL). A total number of 78 vials (25 mL each) were obtained and then analysed by TLC (developed with hexane:ethyl acetate 10% as eluent). The results allowed to combine them into five sub-fractions F<sub>3.1</sub>-F<sub>3.5</sub>.

TLC analysis of the five sub-fractions lead to following conclusions:

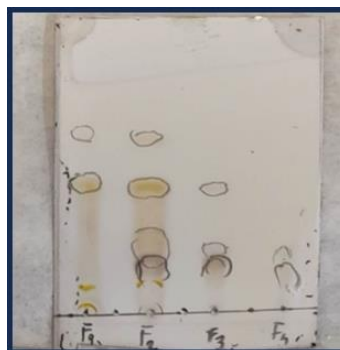
- Fraction F<sub>3.1</sub> corresponds by R<sub>f</sub> to SG<sub>1</sub>
- Fractions F<sub>3.2</sub> and F<sub>3.3</sub> show a similar composition, with SG<sub>1</sub> as one of the major compounds
- Fractions F<sub>3.4</sub> (SG<sub>2</sub>) and F<sub>3.5</sub> (SG<sub>3</sub>) appears to be one single major product each



**Figure 30.** TLC of the F<sub>3</sub> fraction

### 2.2.5. STUDY OF THE F<sub>3.2</sub> AND F<sub>3.3</sub> FRACTION

TLC analysis suggested to combine F<sub>3.2</sub> and F<sub>3.3</sub>, that were then subjected to CC (250 mL with hexane: ethyl acetate 5%, and then 100 mL of methanol). TLC analysis (developed with hexane:ethyl acetate 10% as eluent) of the 40 vials allowed to combine them in 4 sub-fractions F<sub>3.2.1</sub> (6.2 mg), F<sub>3.2.2</sub> (42.8 mg), F<sub>3.2.3</sub> (7.3 mg) and F<sub>3.2.4</sub> (58.7 mg, but with some silica gel). Results are shown in Figure 31.



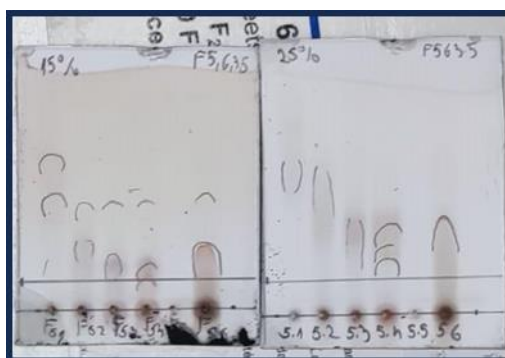
**Figure 31.** TLC analysis of the column chromatography of subfractions F<sub>3.2</sub> and F<sub>3.3</sub>

TLC analysis of the four sub-fractions lead to following conclusions:

- Fraction F<sub>3.2.1</sub> appears to be again SG<sub>1</sub> by R<sub>f</sub> value
- Fraction F<sub>3.2.2</sub> is still a mixture of, at least, 3 major compounds, including SG<sub>1</sub>
- F<sub>3.2.3</sub> appears to have a major compound, not totally pure, with a higher polarity than SG<sub>1</sub>.
- F<sub>3.2.4</sub> appears to be a major compound of higher polarity than F<sub>3.2.3</sub>

### 2.2.6. STUDY OF THE F<sub>5</sub>, F<sub>6</sub> AND F<sub>3.5</sub> FRACTIONS

The similarities observed by TLC in the composition of fractions F<sub>5</sub>, F<sub>6</sub> and F<sub>3.5</sub> suggested to combine them, and subject the combined fraction (58,9 mg) to CC (hexane:ethyl acetate 15 %, 250 mL; 25 %, 250 mL; 100 mL methanol). TLC analysis of the 39 vials lead to the combination in six different sub-fractions F<sub>5.1</sub> (1.8 mg), F<sub>5.2</sub> (2.8 mg), F<sub>5.3</sub> (24.1 mg), F<sub>5.4</sub> (3.5 mg), F<sub>5.5</sub> (0.8 mg) and F<sub>5.6</sub> (15.4 mg). Results are shown in Figure 32.



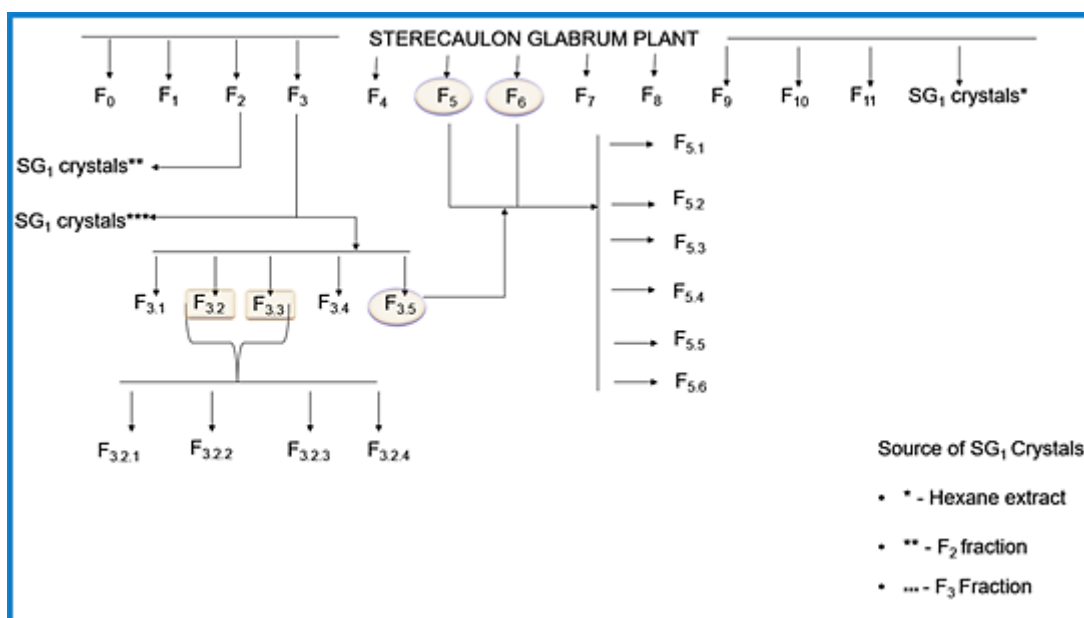
**Figure 32.** TLC plates of column chromatography subfractions  $F_5$ ,  $F_6$ , and  $F_{3.5}$

TLC analysis of the four sub-fractions lead to following conclusions:

- $F_{5.6}$  could be a major compound ( $SG_7$ )
- Effectively, additional purification was needed for all fractions

### 2.2.7. THE SUMMARY OF ALL CC SEPARATIONS

The results of all these separations are summarized in Scheme 1 and Table 3.



**Scheme 1.** Overview of the separation tree of the low-medium polar fractions of the *S. glabrum* extract

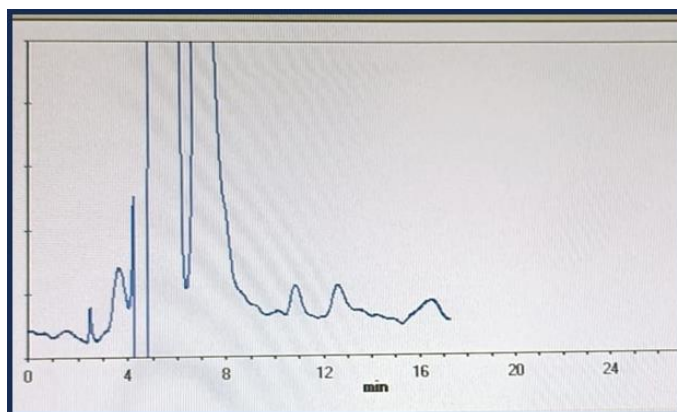
**Table 3.** Masses of fractions (CC – Column chromatography)

1. CC	Mass/ Mg	2. CC	Mass/ Mg	3. CC	Mass /Mg	4. CC	Mass/ Mg
F <sub>0</sub>	38.1	F <sub>3.1</sub>	19.9	F <sub>3.2.1</sub>	6.2	F <sub>5.1</sub>	1.8
F <sub>1</sub>	20	F <sub>3.2</sub>	Not obtained	F <sub>3.2.2</sub>	42.8	F <sub>5.2</sub>	2.8
F <sub>2</sub>	50.1	F <sub>3.3</sub>	0	F <sub>3.2.3</sub>	7.3	F <sub>5.3</sub>	24.1
F <sub>3</sub>	145	F <sub>3.4</sub>	14.7	F <sub>3.2.4</sub>	58.7	F <sub>5.4</sub>	3.5
F <sub>4</sub>	13.3	F <sub>3.5</sub>	11.6			F <sub>5.5</sub>	0.8
F <sub>5</sub>	8.6	SG <sub>1</sub>	Not obtained			F <sub>5.6</sub>	15.4
F <sub>6</sub>	38.7						
F <sub>7</sub>	17.2						
F <sub>8</sub>	26.4						
F <sub>9</sub>	16						
F <sub>10</sub>	145.73						
F <sub>11</sub>	165.1						
SG <sub>1</sub>							

## 2.2.8. HPLC PURIFICATIONS

### *HPLC purification F<sub>3.4</sub> fraction.*

Fraction F<sub>3.4</sub> (14.7 mg) were subjected to High-Performance Liquid Chromatography (HPLC). Separation conditions were set to hexane:ethyl acetate 25 % as mobile phase, in a semi-preparative HPLC column (Lichrospher®) and 1 mL/min flow. The sample was dissolved in a volume of hexane:ethyl acetate 25% enough to inject the sample divided in three injections of 100 µL each. The chromatogram is shown in Figure 33.



**Figure 33.** HPLC chromatogram of the fraction  $F_{3.4}$

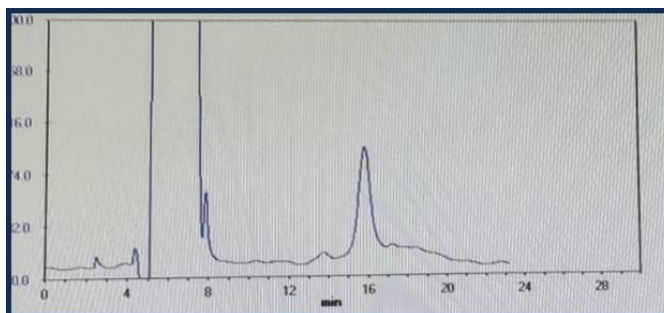
TLC analysis of the different peaks is shown in Figure 34. The results show the existence of pure compounds in vials 7 and 8 of the second and third injections. The rest of vials showed no clear results and were set apart for future study. The rest of vials showed no clear results and were subjected to NMR study. The  $^1\text{H}$  NMR spectra of the different fractions are shown in the annex of spectra. The results of this preliminary study showed the presence of signals in the different sub-fractions ( $F_{3.4.1}$  to  $F_{3.4.6}$ ) corresponding to  $\text{SG}_1$ , a fatty acid and several aromatic compounds. However, none of them were pure enough to accomplish a complete NMR study to elucidate their structure and will be in need of further purification.



**Figure 34.** TLC plates of HPLC analysis of fraction  $F_{3.4}$  (3 injections)

#### **HPLC purification of $F_{3.2.2}$ fraction.**

Purification of fraction  $F_{3.2.2}$  (42.8 mg) was accomplished in a Lichrospher<sup>®</sup> semi-preparative column using as mobile phase a mixture of hexane:ethyl acetate (25%). The sample was divided into five injections (100  $\mu\text{L}$  each). The chromatogram is shown in Figure 35.

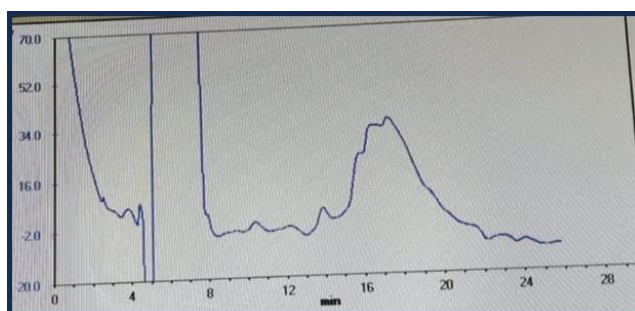


**Figure 35.** Chromatogram of the fraction  $F_{3.2.2}$

The TLC analysis of the vials showed the presence of  $SG_1$  and three more fractions where pure compounds appear to be present (possibly  $SG_4$ ,  $SG_5$  and  $SG_6$ ).

**HPLC purification of  $F_{3.2.3}$  fraction.**

Purification of fraction  $F_{3.2.3}$  (7.3 mg) was accomplished in a Lichrospher® semi-preparative column using as mobile phase a mixture of hexane:ethyl acetate (25%). The sample was injected in a single injection (100  $\mu$ L each). The chromatogram is shown in Figure 36.



**Figure 36.** Chromatogram of the fraction  $F_{3.2.3}$

The TLC analysis of the vials did not show any pure compound. However, some of the vials present a major compound that could be subjected to NMR study.

Regrettably, due to time constraints, the full examination of the remaining fractions remains incomplete and will be the objective of future work by the Cadiz research group. Nonetheless, preliminary findings from the TLC tests support the

possibility of identifying some compounds that will be subjected to NMR study to elucidate their structure.

## 2.3. IDENTIFICATION AND CHARACTERIZATION OF COMPOUNDS

### 2.3.1. NMR AND MS: SELECTION AND PREPARATION OF SAMPLES

The final part of our experiment was to choose the fractions for the MS and NMR analysis. Based on the results of all previous TLC plates, we chose SG1 crystals from the F3 fraction for mass spectrometry (SG1 crystals obtained after Soxhlet extraction), SG1 crystals from fractions F2 and F3, fractions F3.4 (SG<sub>2</sub>) and F5.6 (SG<sub>7</sub>) for nuclear magnetic resonance (NMR). All described samples were tested on a 400MHz equipment, whereas samples from fraction F5.6 were also studied on a 500MHz equipment.



**Figure 37.** Left: NMR samples prepared: SG<sub>1</sub>, SG<sub>1</sub> – F<sub>3</sub>, SG<sub>1</sub> – F<sub>2</sub>, F<sub>3.4</sub>, F<sub>5.6</sub>,  
right: MS sample: SG<sub>1</sub> – F<sub>3</sub>



All samples were dissolved in  $\text{CDCl}_3$  and the residual signal of  $\text{CHCl}_3$  was set to  $\delta$  7.26 ppm for the  $^1\text{H}$  NMR spectrum and to  $\delta$  77.0 ppm for the  $^{13}\text{C}$  NMR spectrum. Coupling constants ( $J$ ) are given in Hz. Multiplicity of signals is indicated as: *s* (singlet), *d* (doublet), *dd* (doublet doublet), *t* (triplet) and *q* (quartet). A comprehensive NMR study of each sample was accomplished by one- and two-dimensional homo- and heteronuclear experiments.

- One-dimensional homonuclear experiments:  $^1\text{H}$ ,  $^{13}\text{C}$
- Two-dimensional homonuclear experiments:  $^1\text{H}$ - $^1\text{H}$  COSY,  $^1\text{H}$ - $^1\text{H}$  NOESY
- Two-dimensional heteronuclear experiments:  $^1\text{H}$ - $^{13}\text{C}$  HSQC;  $^1\text{H}$ - $^{13}\text{C}$  HMBC

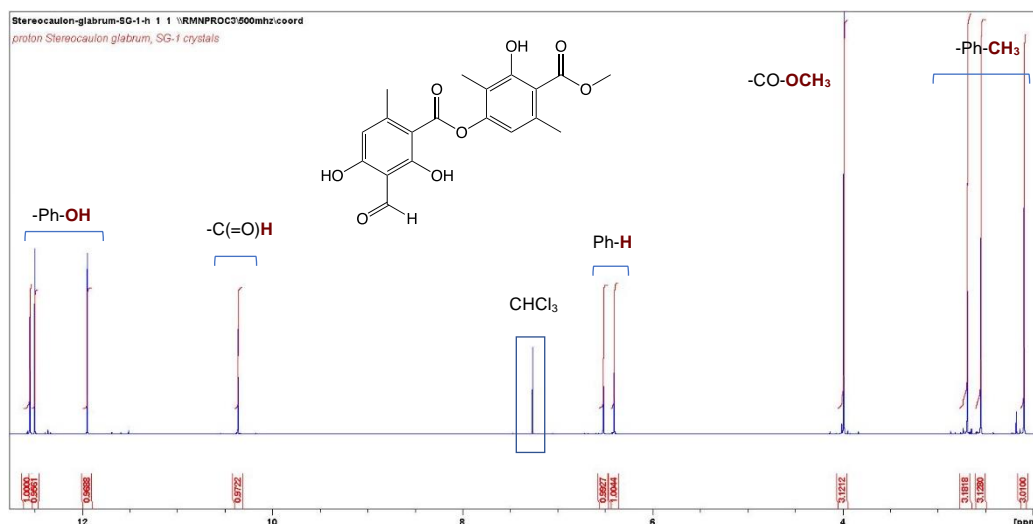
## 2.3.2. RESULTS

### ***NMR STUDIES***

We successfully discovered two significant compounds during our NMR experiments:  $\text{SG}_1$  and  $\text{SG}_7$ . Other substances we examined proved challenging to analyze due to time constraints or the necessity for additional purifications (their spectra can be found in the annex).

#### **$\text{SG}_1$ : Atranorin**

Compound  $\text{SG}_1$  was isolated as white needle crystals and identified as atranorin. The  $^1\text{H}$  and  $^{13}\text{C}$  NMR were recorded in a 400 MHz.  $^1\text{H}$  NMR spectrum (Figure 38) indicated that it was a pure compound and showed the presence of 6 singlets corresponding to one proton each by their intensity, and four singlets corresponding to four different methyl groups. The residual signal of  $\text{CHCl}_3$  from  $\text{CDCl}_3$  can be observed at  $\delta$  7.26 ppm.



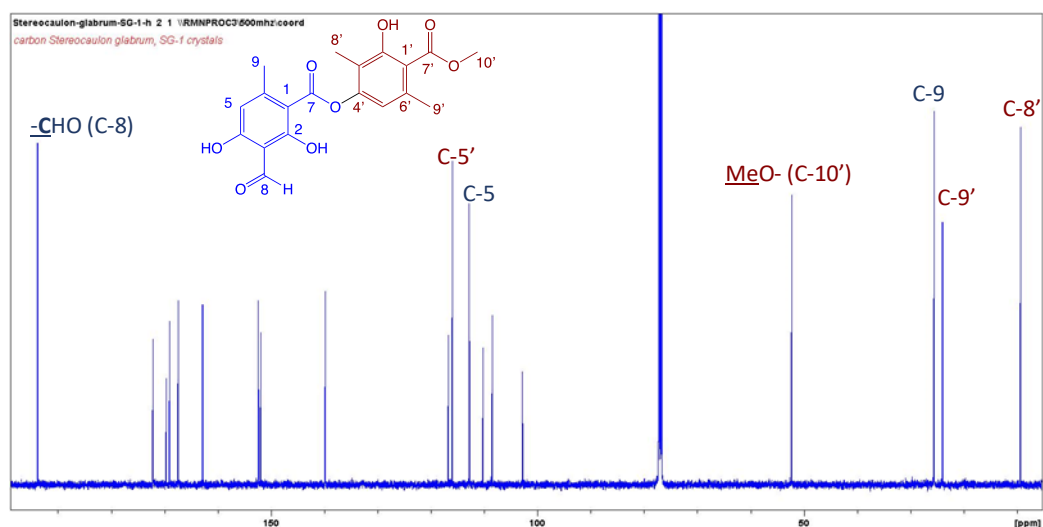
**Figure 38.** <sup>1</sup>H NMR spectrum (with integrals) of atranorin (SG<sub>1</sub>)

Protons at  $\delta$  6.39 ppm (1H, s) and  $\delta$  6.50 ppm (1H, s) correspond to two separate aromatic rings penta-substituted, as they do not show any multiplicity, nor any correlation in the homonuclear two-dimensional <sup>1</sup>H-<sup>1</sup>H COSY experiment (spectrum not shown). The signal at  $\delta$  10.35 ppm (1H, s) is typical of an aldehyde proton while signals at  $\delta$  11.93 ppm (1H, s),  $\delta$  12.49 ppm (1H, s) and  $\delta$  12.54 ppm (1H, s) are typical of hydroxyl groups bound to an aromatic ring. Moreover, the heteronuclear two-dimensional <sup>1</sup>H-<sup>13</sup>C HSQC experiment did not show any correlation among these signals and any <sup>13</sup>C signal, thus confirming the hydroxylic nature of these three protons. The signal at  $\delta$  4.02 ppm (3H, s) is typical of methyl protons from ester group, while the signals at  $\delta$  2.08 ppm (3H, s),  $\delta$  2.53 ppm (3H, s) and  $\delta$  2.65 ppm (3H, s) correspond to methyl groups attached to a phenyl ring.

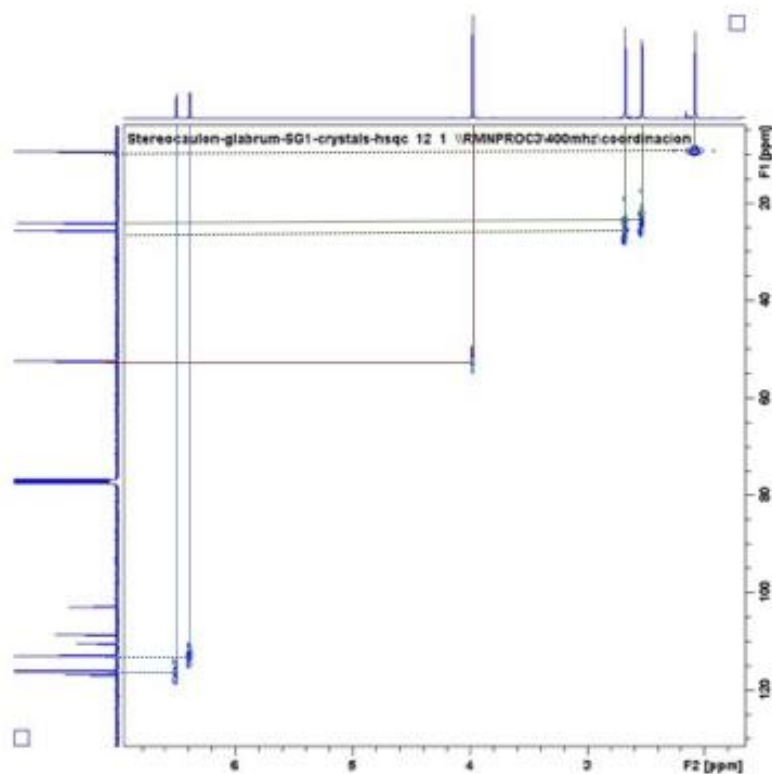
The <sup>13</sup>C NMR spectrum (Figure 39) showed signals corresponding to 19 carbons. The assignment of the protonated carbons was made with the aid of the <sup>1</sup>H-<sup>13</sup>C correlations in the heteronuclear <sup>1</sup>H-<sup>13</sup>C HSQC correlation experiment (Figure 40): methyl protons from ester group at  $\delta$  4.02 ppm (3H, s, H-10') correlate with the <sup>13</sup>C signal at  $\delta$  52.32 ppm (C-10') (in red); the aromatic proton at  $\delta$  6.39 ppm (1H, s, H-5) correlates with the carbon signal at  $\delta$  112.83 ppm (C-5, shown in blue in Figure 39), while the aromatic proton at  $\delta$  6.50 ppm (1H, s, H-5') correlates with the carbon signal at  $\delta$  115.99 ppm (C-5', shown in red in figure

39); the three aromatic methyl groups at  $\delta$  2.08 ppm (3H, s, H-8'),  $\delta$  2.53 ppm (3H, s, H-9') and  $\delta$  2.68 ppm (3H, s, H-9) are connected to the  $^{13}\text{C}$  signals at  $\delta$  9.34 ppm (C-8'),  $\delta$  24.00 ppm (C-9') and  $\delta$  25.56 ppm (C-9), respectively (correlations shown in green in Figure 40).

Finally, the correlations found in the  $^1\text{H}$ - $^1\text{H}$  homonuclear NOESY experiment clearly stated that the methyl group at  $\delta$  2.68 ppm shows a strong nOe correlation with the aromatic proton at  $\delta$  6.39 ppm (Figure 41, in blue); on the other hand, the aromatic proton at  $\delta$  6.50 ppm shows a strong nOe correlation with the methyl group at  $\delta$  2.53 ppm and a less strong one with the methyl protons from ester group at  $\delta$  4.08 ppm (Figure 41, in red).

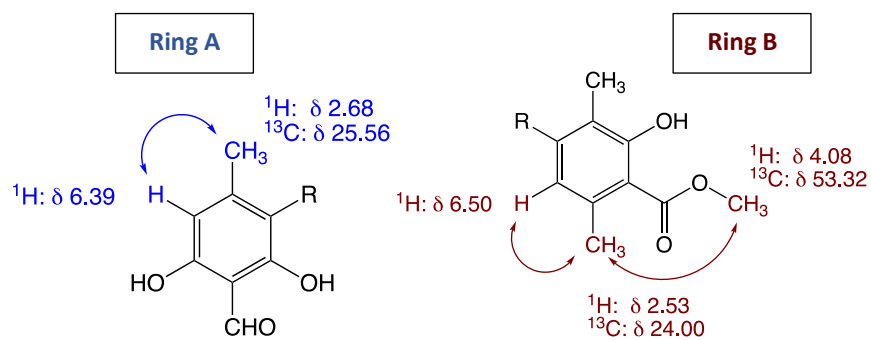


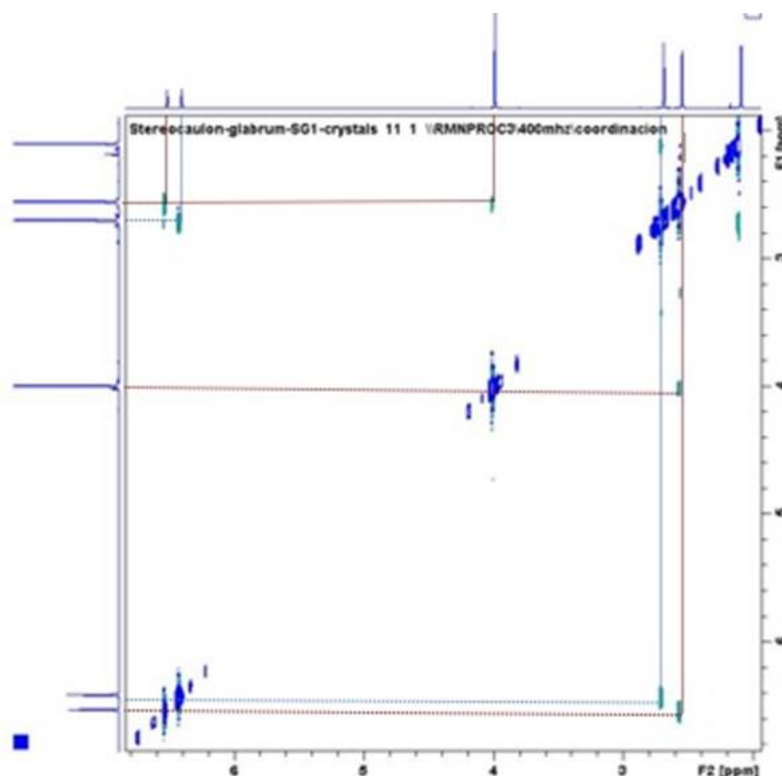
**Figure 39.**  $^{13}\text{C}$  NMR spectrum of atranorin (SG<sub>1</sub>)



**Figure 40.**  $^1\text{H}$ - $^{13}\text{C}$  HSQC heteronuclear correlation spectrum of atranorin ( $\text{SG}_1$ )

The  $^1\text{H}$ - $^1\text{H}$  NOESY correlations clearly allow to separate the signals of the two different aromatic rings of atranorin: ring A (blue) and ring B (red).





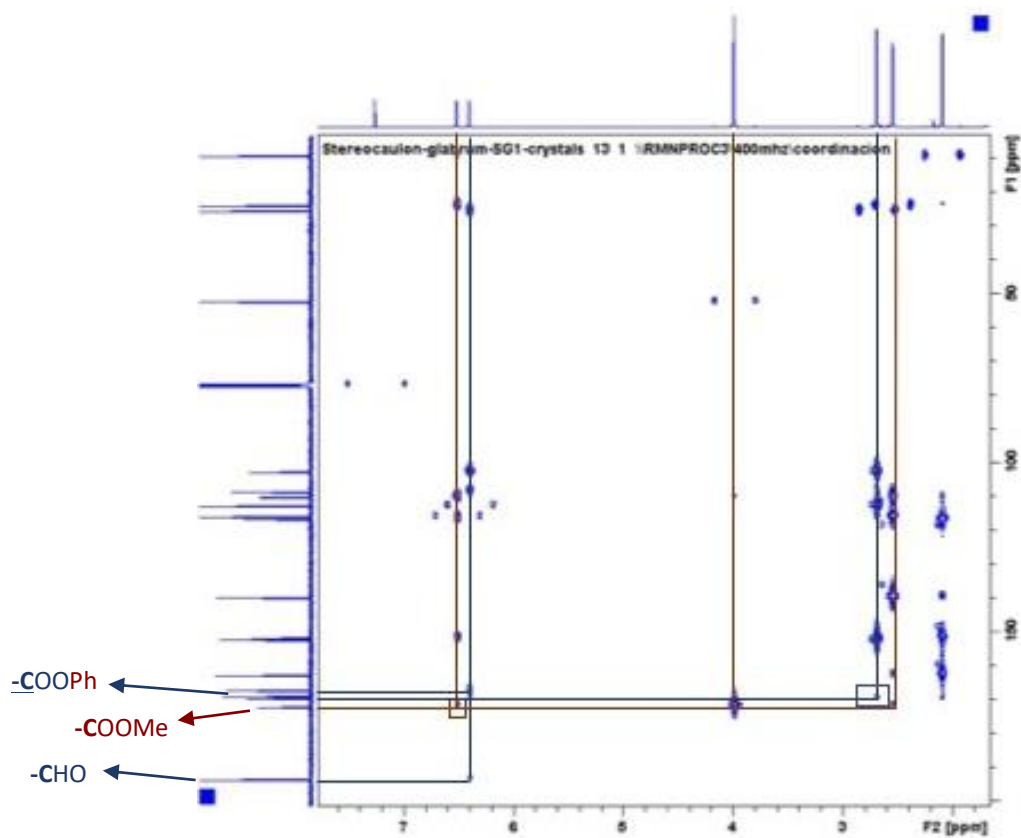
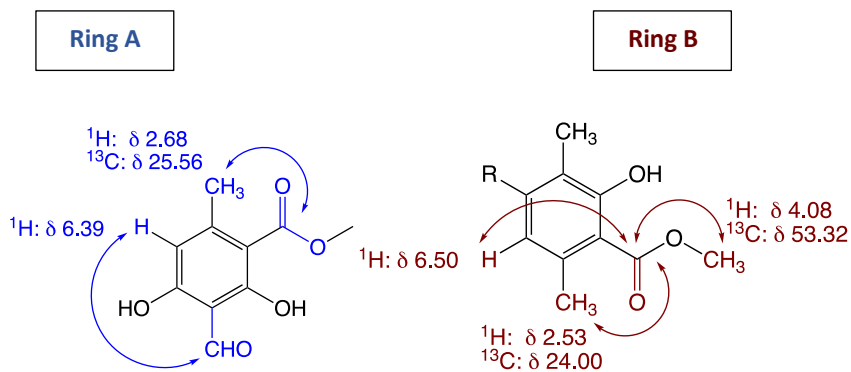
**Figure 41.**  $^1\text{H}$ - $^1\text{H}$  NOESY homonuclear correlation spectrum of atranorin ( $\text{SG}_1$ )

The position of the carbonyl groups of the ester group on ring A and ring B was made based on the positive correlation found in the two-dimensional heteronuclear  $^1\text{H}$ - $^{13}\text{C}$  HMBC correlation experiment (Figure 42).

**Ring A:** the correlation between the aromatic proton at  $\delta$  6.39 ppm (1H, s, H-3, ring A) with the carbonyl signal at  $\delta$  193.82 ppm (C-8) (blue correlation in Figure 42) confirms the presence of the aldehyde group at ring A; on the other hand, the methyl group at 2.68 ppm (3H, s, H-9, ring A) positively correlates with the signal of the carbon in ester group of ring A at  $\delta$  169.67 ppm (C-7).

**Ring B:** the correlation between the methoxy group at  $\delta$  4.02 ppm (3H, s, -OMe) clearly allows to establish that the carbonyl group of the methyl carboxylate (C-7') is the  $^{13}\text{C}$  signal at  $\delta$  172.18 ppm (red correlation in Figure 42); the carbonyl signal shows a weak long-range correlation with the aromatic proton signal at  $\delta$  6.50 ppm (1H, s, H-5, ring B), thus establishing the position of the carboxymethyl group in ring B.

Thus, the nature of the two rings is clearly established. No positive long-range correlations could be found between the two rings, probably due to the long distance between any protonated carbon in one ring and the carbons in the other ring.



**Figure 42.**  $^1\text{H}$ - $^{13}\text{C}$  HMBC long-range heteronuclear correlation spectrum of atranorin (SG<sub>1</sub>)

The rest of the quaternary signals were assigned based on the long-distance correlations found between the  $^1\text{H}$  and the  $^{13}\text{C}$  chemical shift signals in the heteronuclear  $^1\text{H}$ - $^{13}\text{C}$  HMBC experiment. The assignment of the experimental signals of SG<sub>1</sub> (Tables 4 and 5) are in good agreement with those reported in the literature for atranorin,<sup>34</sup> thus confirming the identity of SG<sub>1</sub>.

**Table 4.**  $^1\text{H}$  chemical shifts of atranorin (400 MHz)

	H-5	H-8	H-9	H-5'	H-8'
$\delta$ (ppm)	6.39 (s)	10.34 (s)	2.68 (s)	6.50 (s)	2.08 (s)
	H-9'	H-10'	-OH	-OH	-OH
$\delta$ (ppm)	2.53 (s)	4.02	11.93 (s)	12-49 (s)	12.54 (s)

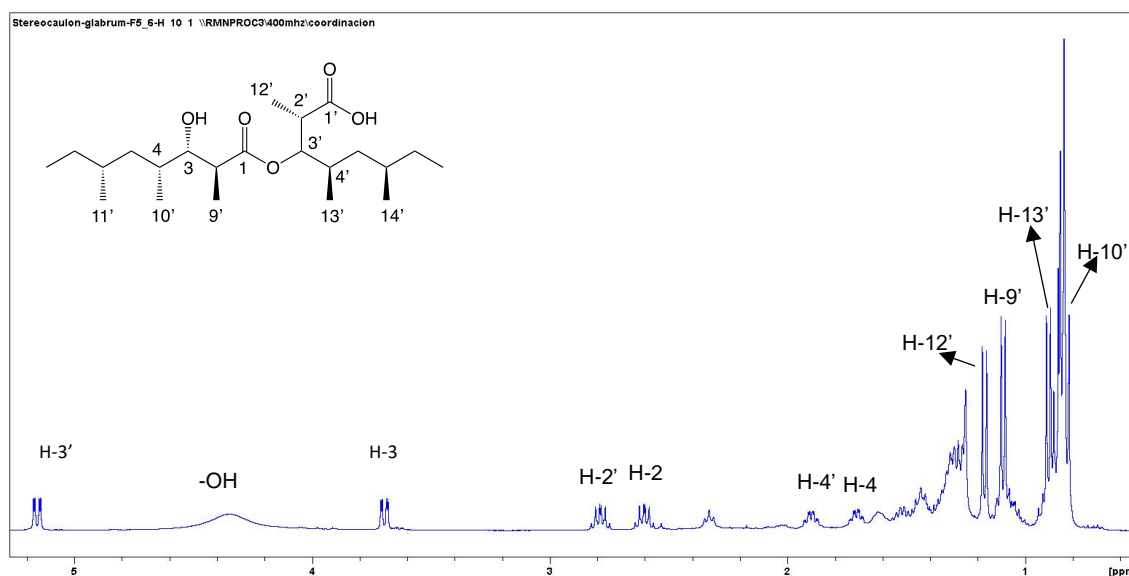
**Table 5.**  $^{13}\text{C}$  chemical shifts of atranorin (400 MHz).

	C-1	C-2	C-3	C-4	C-5	C-6	C-7	C-8
$\delta$ (ppm)	102.81	169.06	108.52	167.46	112.83	152.41	169.67	193.82
	C-9	C-1'	C-2'	C-3'	C-4'	C-5'	C-6'	C-7'
$\delta$ (ppm)	25.56	110.23	162.83	115.99	151.96	172.18	9.34	172.18
	C-8'	C-9'	C-10'					
$\delta$ (ppm)	9.34	24.00	52.32					

### SG<sub>7</sub>: Bourgeanic acid (BA)

While we were able to extract some information on various biological activities of atranorin in the general section of the thesis, no biological activities of bourgeanic acid have been reported so far. Compound SG<sub>7</sub> was isolated as an amorphous white powder and identified as bourgeanic acid. The  $^1\text{H}$  and  $^{13}\text{C}$  NMR were recorded in a 500 MHz.  $^1\text{H}$  NMR spectrum (Figure 43) indicated that

it was a pure compound and showed the presence of several distinct signals in good accordance with the structure of BA: two double doublets at  $\delta$  5.15 ppm (1H, *dd*;  $J = 2.6$  Hz,  $J = 9.6$  Hz, H-3') and  $\delta$  3.68 ppm (1H, *dd*;  $J = 2.5$  Hz,  $J = 9.4$  Hz, H-3) corresponding to protons next to oxygen atoms belonging to a ester group (H-3') and a hydroxyl group (H-3), respectively. Additionally, a broad singlet at  $\delta$  4.4 ppm (1H, *br*, -OH) can be assigned to the proton of the hydroxyl group.



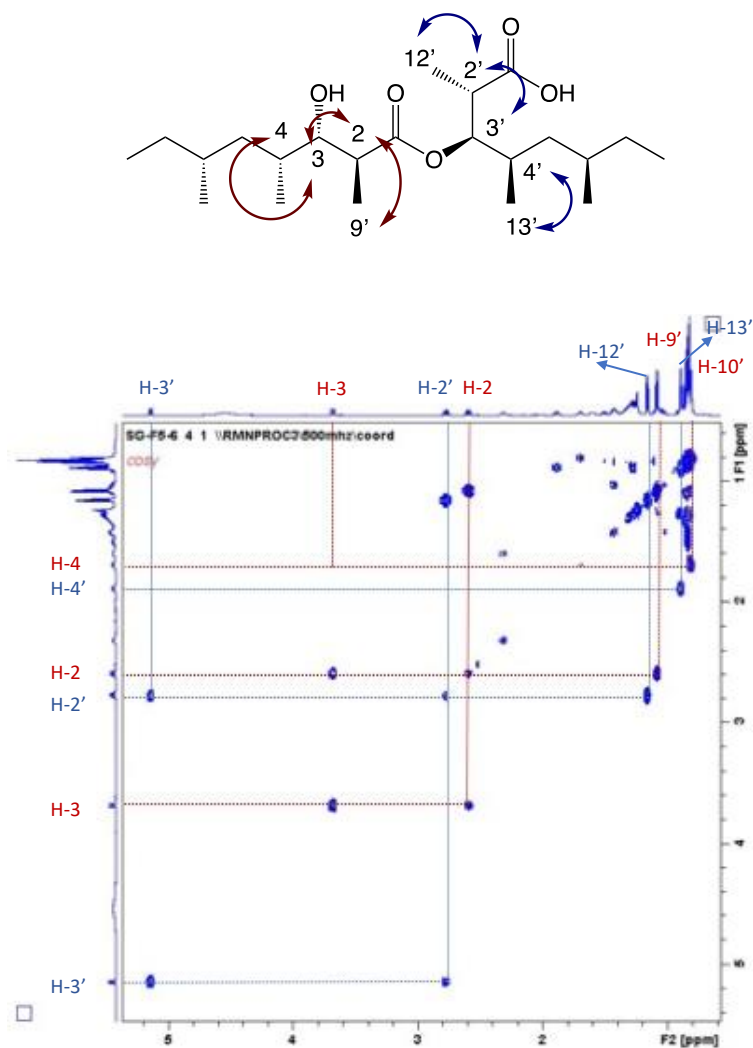
**Figure 43.**  $^1\text{H}$ -NMR spectrum of bourgeanic acid.

The analysis of the correlations found in the homonuclear two-dimensional  $^1\text{H}$ - $^1\text{H}$  COSY experiment (Figure 44) allowed to establish the following correlations:

- The signal corresponding the H-3' proton showed correlations in the homonuclear two-dimensional  $^1\text{H}$ - $^1\text{H}$  COSY with the signal H-2' at  $\delta$  2,78 ppm (1H, *dq*;  $J = 7.1$  Hz,  $J = 9.5$  Hz, H-2') and the methyl group Me-12' at  $\delta$  1.16 ppm (3H, *d*;  $J = 7.1$  Hz, H-12'); additionally, the correlation between the signal at  $\delta$  1.89 ppm (1H, *ddq*;  $J = 2.6$  Hz,  $J = 6.0$  Hz,  $J = 6.0$  Hz, H-4') allows to establish the methyl group Me-13' at  $\delta$  0,89 ppm (3H, *d*;  $J = 6.8$  Hz, H-13') (blue correlations)
- In a similar way, the signal corresponding to the H-3 proton allows to assign the proton signals of H-2 at  $\delta$  2.59 ppm (1H, *dq*;  $J = 7.1$  Hz,  $J = 9.1$  Hz, H-2) and H-4  $\delta$  1.70 ppm (1H, *ddq*;  $J = 2.5$  Hz,  $J = 6.8$  Hz,  $J = 6.8$  Hz,



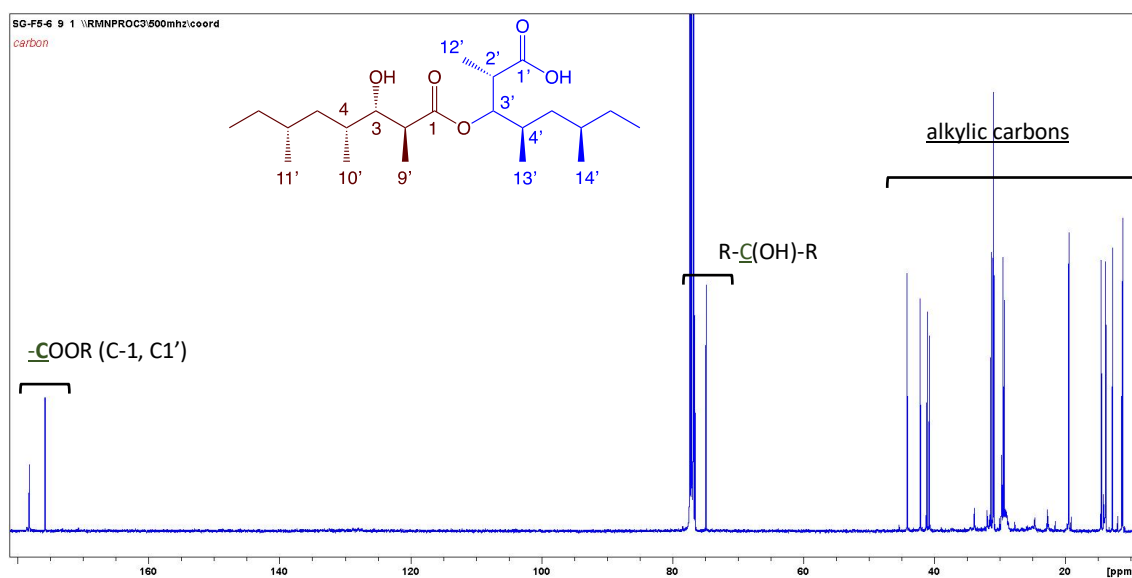
H-4); the correlation between H-2 and the signal at  $\delta$  1,08 ppm (3H, *d*;  $J$  = 7.1 Hz, H-9') allows to establish the position of the methyl group C-9'; finally, the correlation between the signal corresponding to H-4 and the signal at  $\delta$  0.81 ppm (3H, *d*;  $J$  = 6.8 Hz, H-10') allows to establish the position of the methyl group C-10';



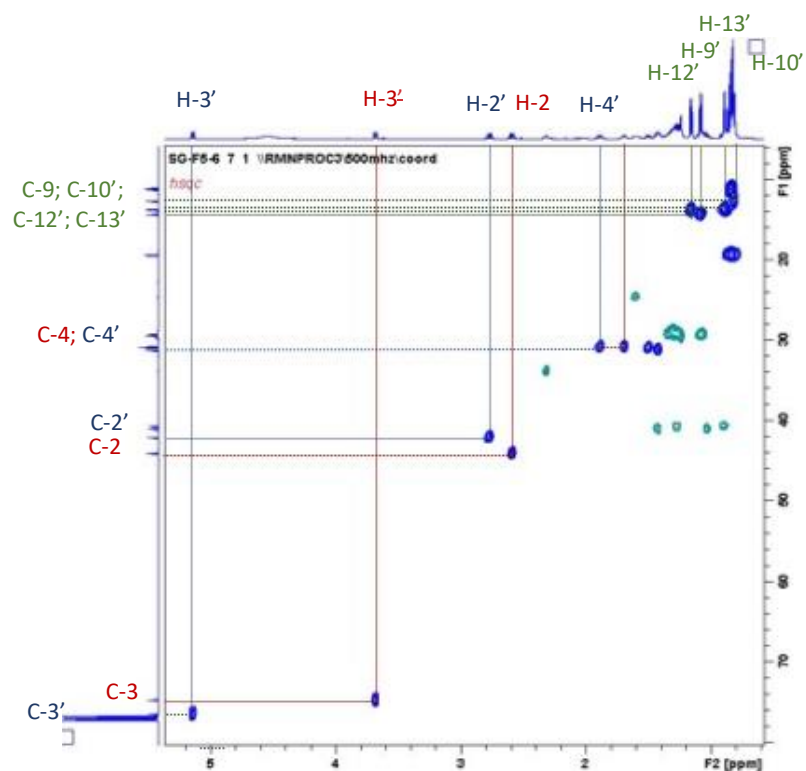
**Figure 44.**  $^1\text{H}$ - $^1\text{H}$  COSY correlations of bourgeanic acid.

The  $^{13}\text{C}$  NMR spectrum shows signals typical of an alkylic compound with two carbonyl groups at  $\delta$  178.17 ppm and  $\delta$  175.77 ppm, two carbons bearing an oxygen atom at  $\delta$  76.50 ppm and  $\delta$  74.80 ppm, and eighteen alkylic carbons (Figure 45). The correlations found in the two-dimensional  $^1\text{H}$ - $^{13}\text{C}$  heteronuclear HSQC experiment (Figure 46) allowed to:

- assign the carbon signals at  $\delta$  76.50 (C-3'),  $\delta$  42.07 (C-2') and  $\delta$  30.96 (C-4', overlapped with C-4) (in blue),
- assign the carbon signals  $\delta$  74.80 (C-3),  $\delta$  44.08 (C-2) and  $\delta$  30.96 (C-4, overlapped with C-4') (in red),
- assign the methyl groups at 12.67 (C-10'), 13.73 (C-12'), 13.78 (C-13') and 14.40 (C-9') (in green).



**Figure 45.**  $^{13}\text{C}$  NMR spectrum of bourgeanic acid (SG<sub>2</sub>)



**Figure 46.**  $^1\text{H}$ - $^{13}\text{C}$  HSQC heteronuclear correlation spectrum of bourgeanic acid ( $\text{SG}_2$ )

The rest of the  $^1\text{H}$  and  $^{13}\text{C}$  signals were assigned based on the long-distance correlations found between the  $^1\text{H}$  and the  $^{13}\text{C}$  chemical shift signals in the heteronuclear  $^1\text{H}$ - $^{13}\text{C}$  HMBC experiment. The assignment of the experimental signals of  $\text{SG}_2$  (Tables 6 and 7) are in good agreement with those reported in the literature for bourgeanic acid<sup>35</sup>, thus confirming the identity of  $\text{SG}_7$ .

**Table 6.**  $^1\text{H}$  chemical shifts of bourgeanic acid (500 MHz). Coupling constants are given in Hertz (in parenthesis); a: signals can be interchanged

	H-2	H-3	H-4	H-5	H-6
$\delta$ (ppm)	2.59 ( <i>dq</i> , 7.1, 9.1)	3.68 ( <i>dd</i> , 2.5, 9.4)	1.70 ( <i>ddq</i> , 2.5, 6.8, 6.8)		
	H-7	H-8	H-9'	H-10'	H-11'
$\delta$ (ppm)		0.85 ( <i>t</i> , 7.5) <sup>a</sup>	1.08 ( <i>d</i> , 7.1)	0.81 ( <i>d</i> , 6.8)	
	H-2'	H-3'	H-4'	H-5'	H-6'
$\delta$ (ppm)	2.78 ( <i>dq</i> , 7.1, 9.5)	5.15 ( <i>dd</i> , 2.6, 9.6)	1.89 ( <i>ddq</i> , 2.6, 6.0, 6.0)		
	H-7'	H-8'	H-12'	H-13'	H-14'
$\delta$ (ppm)		0.83 ( <i>t</i> , 7.5) <sup>a</sup>	1.16 ( <i>d</i> , 7.1)	0.89 ( <i>d</i> , 6.8)	

**Table 7.**  $^{13}\text{C}$  chemical shifts of bourgeanic acid (500 MHz). a: signals can be interchanged: \*: overlapped signals.

	C-1	C-2	C-3	C-4	C-5	C-6	C-7	C-8
$\delta$ (ppm)	175.57	44.08	74.80	30.96*				11.14 <sup>a</sup>
	C-1'	C-2'	C-3'	C-4'	C-5'	C-6'	C-7'	C-8'
$\delta$ (ppm)	178.17	42.07	76.50	30.96*				10.39 <sup>a</sup>
	C-9'	C-10'	C-11'	C-12'	C-13'	C-14'		
$\delta$ (ppm)	14.90	12.67		13.73	13.78			

In summary, our SG<sub>1</sub> compound, now known as atranorin, was first discovered in a hexane extract as white crystals (116 mg). Our second encounter with pure SG<sub>1</sub> (indicated by TLC results) was after column chromatography, specifically F<sub>2</sub> (50,1 mg) and F<sub>3.1</sub> (19,9 mg) fractions. SG<sub>7</sub>, now known as bourgeanic acid, was isolated by column chromatography, specifically in an F<sub>5.6</sub> fraction with a total weight of 15,4 mg.

### 3. CONCLUSIONS

Based on all the research done in this thesis on the lichen *Stereocaulon glabrum*, the following conclusions may be drawn:

- The optimal separation conditions are provided by the hexane:ethyl acetate solvent system, according to the preliminary TLC study's results.
- From all utilized fractions, a total of 169,1 mg of SG<sub>1</sub> pure crystals (atranorin) were separated (hexane extract = 116,1 mg, F<sub>2</sub> fraction = 13,1 mg, F<sub>3</sub> fraction = 40 mg).
- Pure crystals (SG<sub>1</sub>) were formed directly in our extract (hexane) and fractions (F<sub>2</sub> and F<sub>3</sub>) before starting any separation processes with CC and HPLC.
- The signals that follow assist us in determining the SG<sub>1</sub> (atranorin) structure. The existence of two aromatic rings was indicated by distinctive peaks in the 5 to 6 ppm range of the <sup>1</sup>H NMR spectra, which provided primary support for the identification. Furthermore, the presence of three hydroxyl groups was verified using the HSQC, which identifies <sup>1</sup>H–<sup>13</sup>C direct bonding. The characterization of the compound is further enhanced by the presence of an aldehyde group, which usually resides in the range between 10-12 ppm in the <sup>1</sup>H NMR spectrum.
- Atranorin, a depside that was successfully isolated from our sample, is one of the most abundant secondary metabolites found in the *Stereocaulon* genus.
- Total weight of the F<sub>5.6</sub> fraction which contained SG<sub>7</sub>, known as bourgeanic acid, was 15,4 mg.
- To obtain SG<sub>7</sub> three CC were needed in total, the main one in which we obtained eleven different fractions and SG<sub>1</sub> crystals, second one which focused only on F<sub>3</sub> fraction and third one which combined F<sub>5</sub>, F<sub>6</sub> and F<sub>3.5</sub> fraction.

- We successfully isolated a less common secondary metabolite known as bourgeanic acid, which can also be found in *Stereocaulon tomentosum*.

#### 4. ABBREVIATIONS

ROS – Reactive oxygen species

CC – Column chromatography

HPLC – High performance liquid chromatography

TLC – Thin layer chromatography

R<sub>f</sub> – Retention factor

NMR – Nuclear magnetic resonance

COSY – Correlation spectroscopy

NOESY – Nuclear Overhauser effect spectroscopy

nOE - Nuclear Overhauser effect

HSQC – Heteronuclear single quantum coherence

HMBC – Heteronuclear multiple bond correlation

MS – Mass spectrometry

UV – Ultra-violet

QTOF – Quadrupole time- of- flight

UPLC – Ultra performance liquid chromatography

GC – Gas chromatography

*spp.* – several species

BA – Bourgeanic acid

HexS – Hexane Soxhlet extraction

HexU – Hexane ultrasound

AceS – Acetone Soxhlet extraction

AceU – Acetone ultrasound

iPrOHS – Isopropanol Soxhlet extraction

iPrOHU – Isopropanol ultrasound

## 5. BIBLIOGRAPHY

1. Gómez-Serranillos, M.P., Fernández-Moriano, C., González-Burgos, E., Divakar, P.K., & Crespo, A., Parmeliaceae family: phytochemistry, pharmacological potential and phylogenetic features. *RSC Advances*. **2014**. 4(103): 59017-59047. doi:10.1039/c4ra09104c
2. Solárová, Liskova, Samec, Kubatka, Büsselberg, Solár, Anticancer Potential of Lichens' Secondary Metabolites. *Biomolecules*. **2020**. 10(1), 87: doi:10.3390/biom10010087
3. URL: [https://www.inaturalist.org/guide\\_taxa/40915](https://www.inaturalist.org/guide_taxa/40915) (5. 8. 2023.)
4. URL: [https://redlist.info/iucn/species\\_view/430182](https://redlist.info/iucn/species_view/430182) (5. 8. 2023.)
5. Friardi Ismed, Françoise Lohézic-Le Dévéhat, Annie Guiller, Nina Corlay, Amri Bakhtiar & Joel Boustie, Phytochemical review of the lichen genus *Stereocaulon* (Fam. Stereocaulaceae) and related pharmacological activities highlighted by a focus on nine species. *Phytochem. Rev.* **2018**, 17(5): 1165-1178. <https://doi.org/10.1007/s11101-018-9576-y>.
6. Shukla Vertika, Kumar Sanjeev, Kumar Narendra. (eds), Armstrong, R.A, Adaptation of Lichens to Extreme Conditions. *Plant Adaptation Strategies in Changing Environment*. **2017**, (7) :1-27 [https://doi.org/10.1007/978-981-10-6744-0\\_1](https://doi.org/10.1007/978-981-10-6744-0_1)
7. Ibrahim SRM, Sirwi A, Eid BG, Mohamed SGA, Mohamed GA, Fungal Depsides-Naturally Inspiring Molecules: Biosynthesis, Structural Characterization, and Biological Activities. *Metabolites*. **2021**, 11(10): 683. doi: 10.3390/metabo11100683.
8. Galanty A, Koczurkiewicz P, Wnuk D, Usnic acid and atranorin exert selective cytostatic and anti-invasive effects on human prostate and melanoma cancer cells. *Toxicol In Vitro*. **2017**, 40: 161-169. doi:10.1016/j.tiv.2017.01.008.
9. Pompilio Arianna, Pomponio Stefano, Di Vincenzo Valentina, Crocetta Valentina, Nicoletti Marcello, Piovano Marisa, Garbarino Juan A, Di Bonaventura Giovanni, Antimicrobial and antibiofilm activity of secondary metabolites of lichens against methicillin-resistant *Staphylococcus aureus* strains from cystic fibrosis patients. *Future Microbiology*. **2013**. 8(2): 281–292. doi:10.2217/fmb.12.142.



10. Barreto Rosana S.S., Albuquerque-Júnior Ricardo L.C., Pereira-Filho Rose Nely, Quintans Jullyana S.S., Barreto André S., DeSantana Josimari M., Santana-Filho Valter J., Santos Marcio R.V., Bonjardim Leonardo R., Araújo Adriano A.S., Quintans-Júnior Lucindo J., Evaluation of wound healing activity of atranorin, a lichen secondary metabolite, on rodents. *Revista Brasileira de Farmacognosia*. **2013**. 23(2): 310–319. doi:10.1590/S0102-695X2013005000010
11. . Bhattacharyya Dr Shantanu, Deep Pratibha, Singh Sunita, Nayak Binata, Lichen Secondary Metabolites and Its Biological Activity. *American journal of Pharmtech Research* 2249-3387.6. **2016**. 95(29): 28-44. <http://www.ajptr.com/>.
12. Urbanska N, Simko P, Leskanicova A, Karasova M, Jendzelovska Z, Jendzelovsky R, Rucova D, Kolesarova M, Goga M, Backor M, Atranorin, a Secondary Metabolite of Lichens, Exhibited Anxiolytic/Antidepressant Activity in Wistar Rats. *Life*. **2022**, 12(11): 1850. <https://doi.org/10.3390/life12111850>.
13. Ureña-Vacas, Isabel, Elena González-Burgos, Pradeep Kumar Divakar and María Pilar Gómez-Serranillos, "Lichen Depsidones with Biological Interest." *Planta Medica* **2021**, 135 (15). doi: 10.1055/a-1482-6381
14. Lee S, Suh YJ, Yang S, Hong DG, Ishigami A, Kim H, Hur J-S, Chang S-C, Lee J., Neuroprotective and Anti-Inflammatory Effects of Evernic Acid in an MPTP-Induced Parkinson's Disease Model. *International Journal of Molecular Sciences*. **2021**. 22(4): 2098. <https://doi.org/10.3390/ijms22042098>
15. Bhattarai H. D., Paudel B., Hong S. G., Lee H. K., Yim J. H., Thin layer chromatography analysis of antioxidant constituents of lichens from Antarctica. *Journal of Natural Medicines*. **2008**. 62(4): 481–484. doi:10.1007/s11418-008-0257-9.
16. Morita H, Tsuchiya T, Kishibe K, Noya S, Shiro M, Hirasawa Y., Antimitotic activity of lobaric acid and a new benzofuran, sakisacaulon A from *Stereocaulon sasakii*. *Bioorg Med Chem Lett*. **2009**. 19(13): 3679-3681. doi:10.1016/j.bmcl.2009.03.170.
17. Ismed F, Lohézic-Le Dévéhat F, Delalande O, Sinbandhit S, Bakhtiar A, Boustie J., Lobarin from the Sumatran lichen, *Stereocaulon halei*. *Fitoterapia*. **2012**. 83(8): 1693-1698. doi:10.1016/j.fitote.2012.09.025.

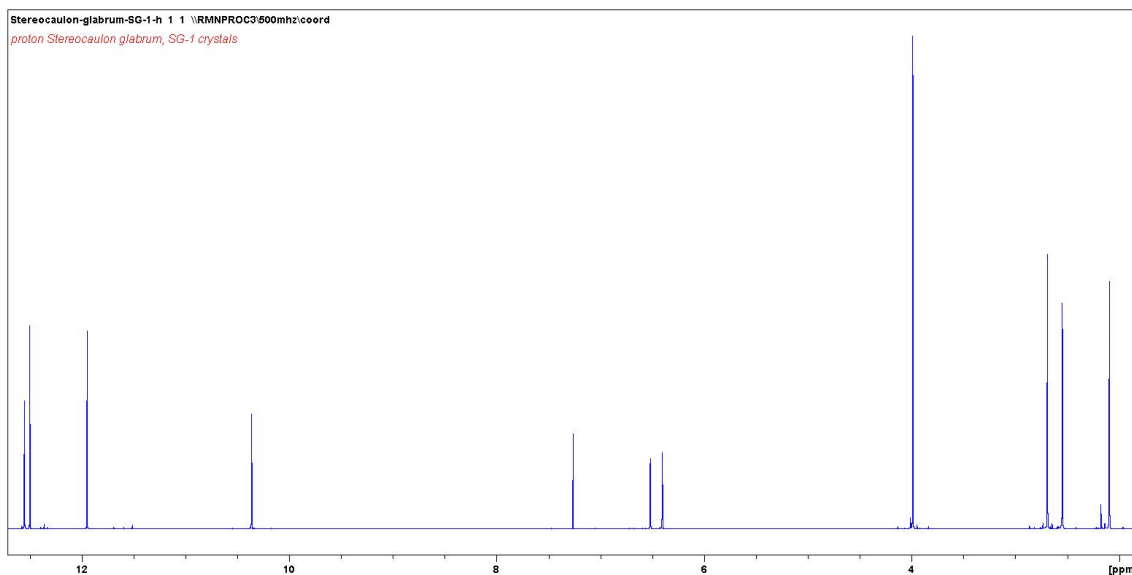
18. Millot M, Dieu A, Tomasi S, Dibenzofurans and derivatives from lichens and ascomycetes. *Nat Prod Rep.* **2016**, 33(6): 801-811. doi:10.1039/c5np00134j.
19. Salvatore Caccamese,\* Anna Companini, Rosa Maria Toscano, Orazio Cascio, Methyl  $\beta$ -Orcinolcarboxylate and Atranol from the lichen *Stereocaulon vesuvianum*. *J. Nat. Prod.* **1986**. 49(7): 1159-1160. <https://doi.org/10.1021/np50048a049>.
20. Stojanović G, Zlatanović I, Zrnzević I, Stanković M, Stankov Jovanović V, Zlatković B., Hypogymnia tubulosa extracts: chemical profile and biological activities. *Nat Prod Res.* **2018**. 32(22): 2735-2739. doi:10.1080/14786419.2017.1375926.
21. Manojlovic NT, Vasiljevic PJ, Maskovic PZ, Juskovic M, Bogdanovic-Dusanovic G., Chemical Composition, Antioxidant, and Antimicrobial Activities of Lichen *Umbilicaria cylindrica* (L.) Delise (Umbilicariaceae). *Evid Based Complement Alternat Med.* **2012**. 28: 1-8. doi:10.1155/2012/452431.
22. Gaspar Diaz, Izabel Miranda, Suele Karine Sartori, Daniele C. De Rezende, Anthraquinones: An Overview. *Studies in Natural Products Chemistry.* **2018**, 1(63): 313-338. <https://doi.org/10.1016/B978-0-444-64056-7.00011-8>.
23. Vidal I, Torres-Vargas JA, Sánchez JM, Trigal M, García-Caballero M, Medina MÁ, Quesada AR., Danthron, an Anthraquinone Isolated from a Marine Fungus, Is a New Inhibitor of Angiogenesis Exhibiting Interesting Antitumor and Antioxidant Properties. *Antioxidants.* **2023**. 12(5): 1101. <https://doi.org/10.3390/antiox12051101>.
24. Chen H, Zhao C, He R, Zhou M, Liu Y, Guo X, Wang M, Zhu F, Qin R, Li X., Danthron suppresses autophagy and sensitizes pancreatic cancer cells to doxorubicin. *Toxicol In Vitro.* **2019**. 54: 345-353. doi:10.1016/j.tiv.2018.10.019.
25. Coopoosamy Roger, Magwa M. L., Antibacterial activity of chrysophanol isolated from *Aloe excelsa* (Berger). *AFRICAN JOURNAL OF BIOTECHNOLOGY.* **2006**. 14(31). doi:10.4314/ajb.v5i16.43147.
26. Seigler DS., Plant Secondary Metabolism. *Springer Science & Business Media.* **2012**. 759.

27. Gallo Margareth, Miranda Bullet, Sarachine J., Biological Activities of Lupeol. *International Journal of Biomedical and Pharmaceutical Sciences*. 3. 46-66. **2009**. 65(231): 1-22. <https://www.researchgate.net/publication/227878150>.
28. Mus AA, Goh LPW, Marbawi H, Gansau JA., The Biosynthesis and Medicinal Properties of Taraxerol. *Biomedicines*. **2022**. 114(7): 807. <https://doi.org/10.3390/biomedicines10040807>.
29. Dupont S, Fleurat-Lessard P, Cruz RG, Lafarge C, Grangeteau C, Yahou F, Gerbeau-Pissot P, Abrahão Júnior O, Gervais P, Simon-Plas F, Antioxidant Properties of Ergosterol and Its Role in Yeast Resistance to Oxidation. *Antioxidants*. **2021**. 61(10): 1024. <https://doi.org/10.3390/antiox10071024>.
30. Xiong Mingrui, Huang Yun, Liu Yajing, Huang Mi, Song Guanjun, Ming Qian, Ma Xinhua, Yang Jie, Deng Shihao, Wen Yanzhang, Shen Jinhua, Liu Qing-Hua, Zhao Ping, Yang Xinzhou, Antidiabetic Activity of Ergosterol from *Pleurotus Ostreatus* in KK-A<sup>y</sup> Mice with Spontaneous Type 2 Diabetes Mellitus. *Molecular Nutrition & Food Research*. **2017**. 42(47): 1-43. doi:10.1002/mnfr.201700444.
31. Ghosh S, Sudha ML, A review on polyols: new frontiers for health-based bakery products. *Int J Food Sci Nutr*. **2012**, 63(3): 372-379. doi:10.3109/09637486.2011.627846.
32. Spribille T, Resl T, Stanton DE, Tagirdzhanova G., Evolutionary biology of lichen symbiosis. *The New Phytologist* **2022**. 234(5): 1566-1582. doi: 10.1111/nph.18048
33. I. S. M. Rafiqul, A. M. Mimi Sakinah, Processes for the Production of Xylitol – A review, *Food Reviews International* 29:2. **2013**. 144(117): 127-156. doi:10.1080/87559129.2012.714434.
34. Carvalho MG, de Carvalho GJA, Braz-Filho R, Chemical Constituents from *Ouratea floribunda*: Complete <sup>1</sup>H and <sup>13</sup>C NMR: Assignments of Atranorin and its New Acetyl Derivative. *Journal of the Brazilian Chemical Society* **2000**. 11(2): 143-147. <https://doi.org/10.1590/S0103-50532000000200007>
35. Yadav JHS, Raghavendra Rao KV, Ravindar K, Subba Reddy RB, Total Synthesis of (+)-Bourgeanic Acid utilizing desymmetrization strategy. *European*

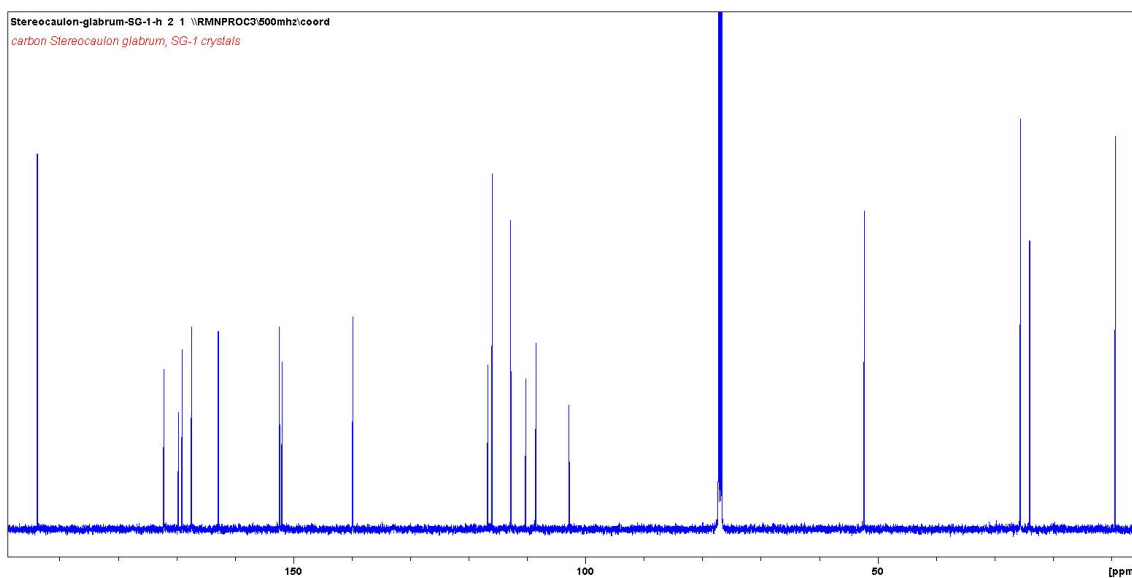
*Journal or Organic Chemistry* **2011**, 58-61.  
<https://doi.org/10.1002/ejoc.201001199>

## 6. SUPPLEMENTARY/ANNEX

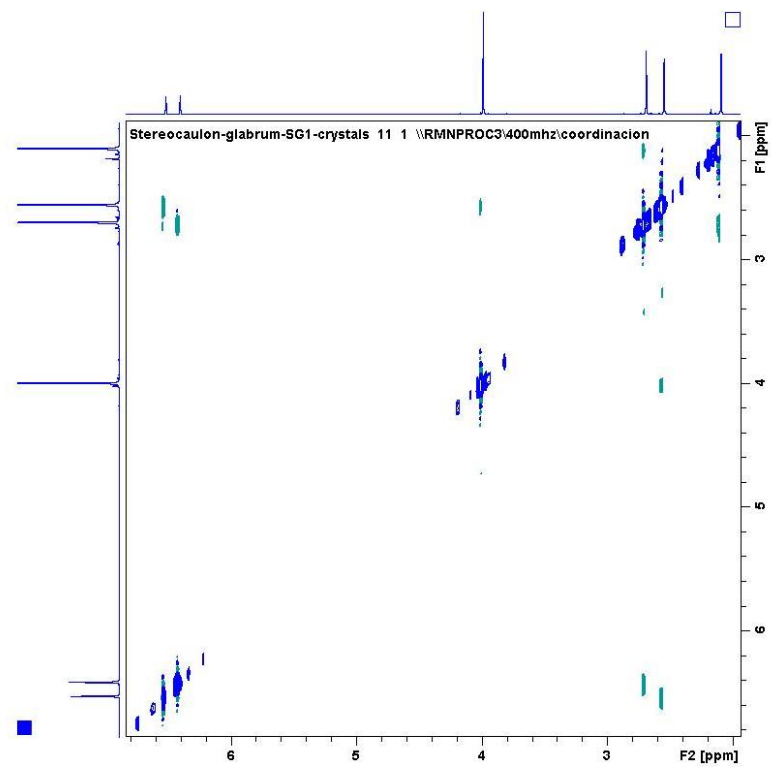
### Section 1. Spectra of atranorin



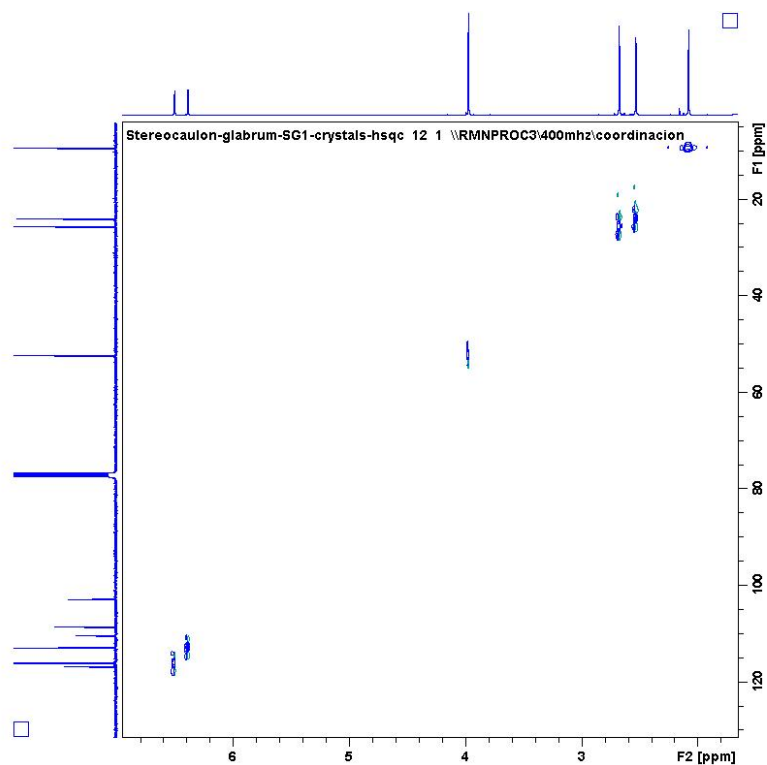
**Figure S1** <sup>1</sup>H - NMR spectrum (500 MHz) of atranorin.



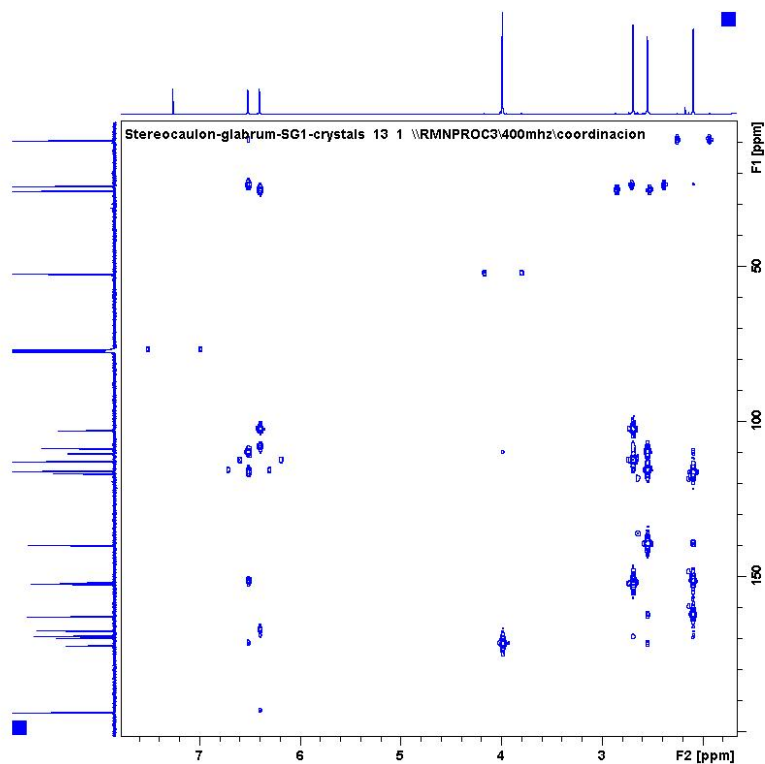
**Figure S2** <sup>13</sup>C - NMR spectrum (500 MHz) of atranorin.



**Figure S3**  $^1\text{H}$  -  $^1\text{H}$  NOESY correlation spectrum (400 MHz) of atranorin.

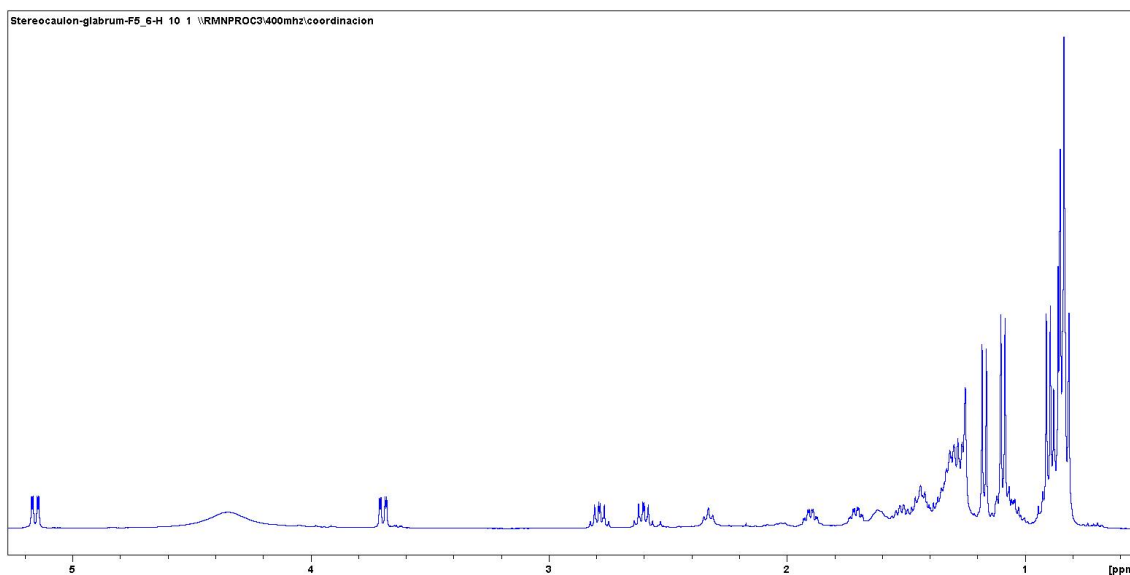


**Figure S4**  $^1\text{H}$  -  $^{13}\text{C}$  HSQC correlation spectrum (400 MHz) of atranorin.



**Figure S5**  $^1\text{H}$  - $^{13}\text{C}$  HMBC long-range correlation spectrum (500 MHz) of atranorin

## Section 2. Spectra of bourgeanic acid



**Figure S6**  $^1\text{H}$  - NMR spectrum (400 MHz) of bourgeanic acid.

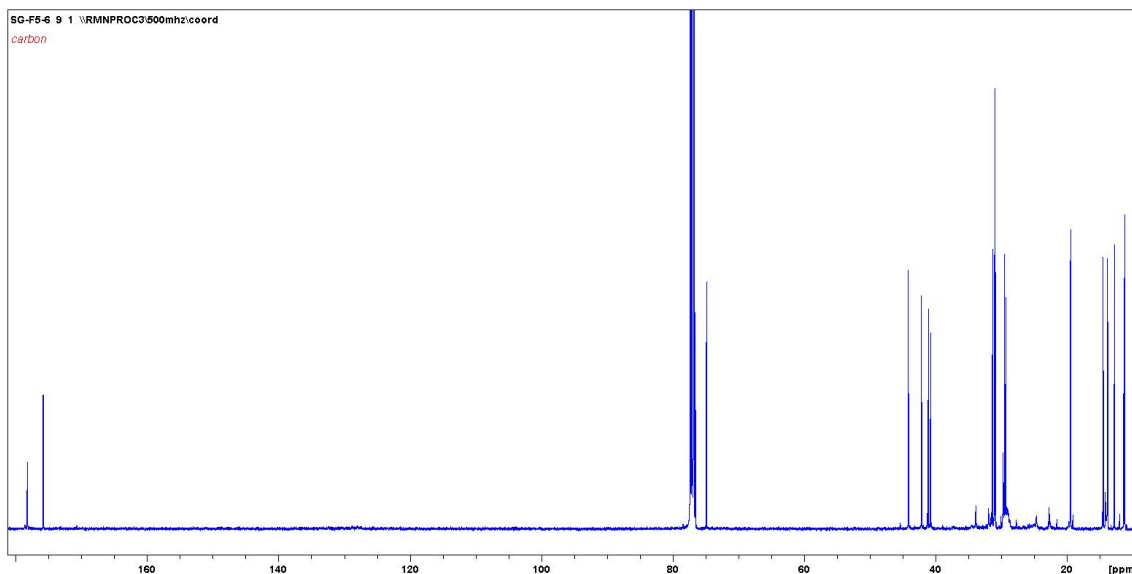


Figure S7 <sup>13</sup>C - NMR spectrum (500 MHz) of bourgeanic acid.

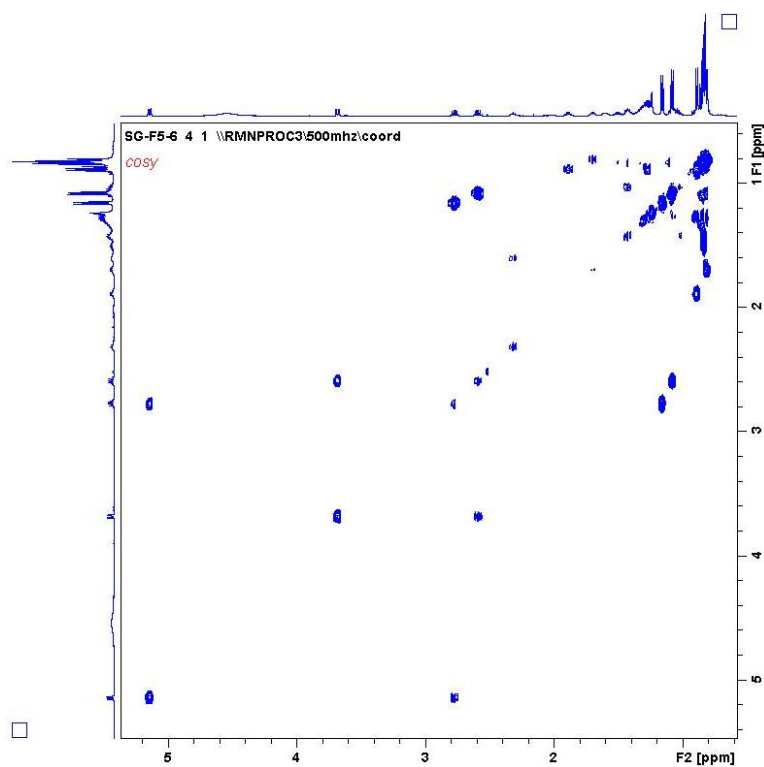
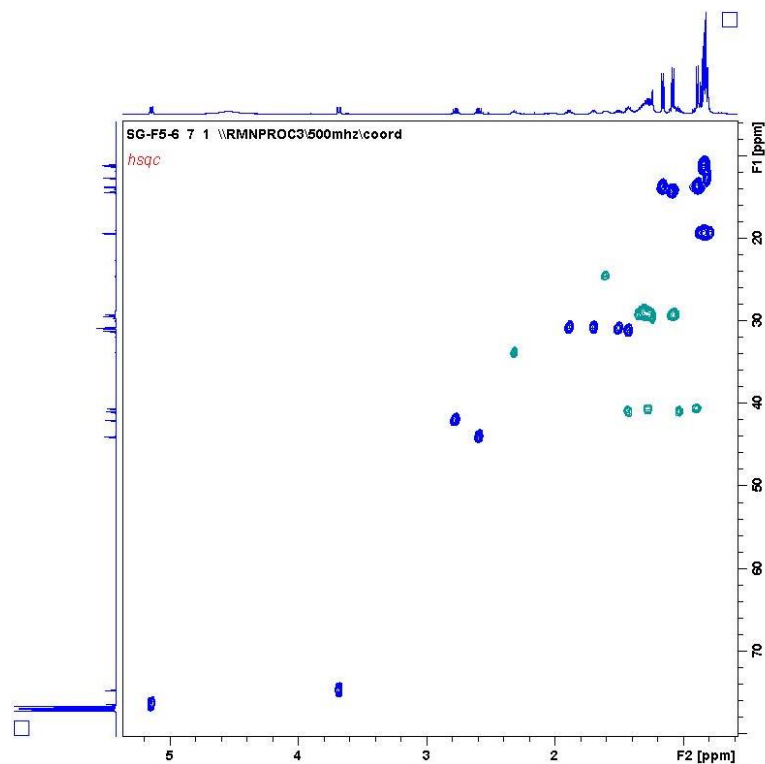
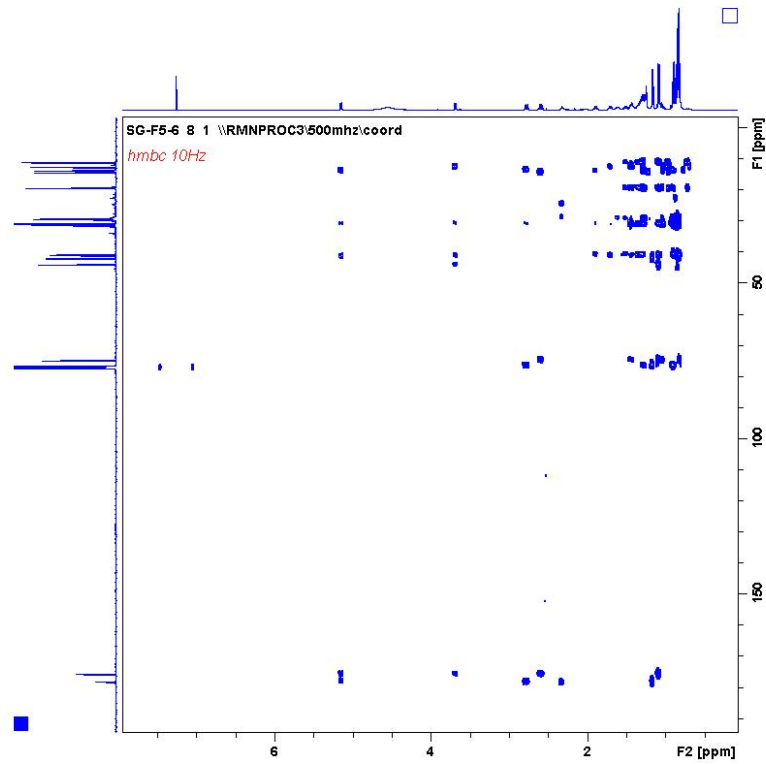


Figure S8 <sup>1</sup>H -<sup>1</sup>H COSY correlation spectrum (500 MHz) of bourgeanic acid.



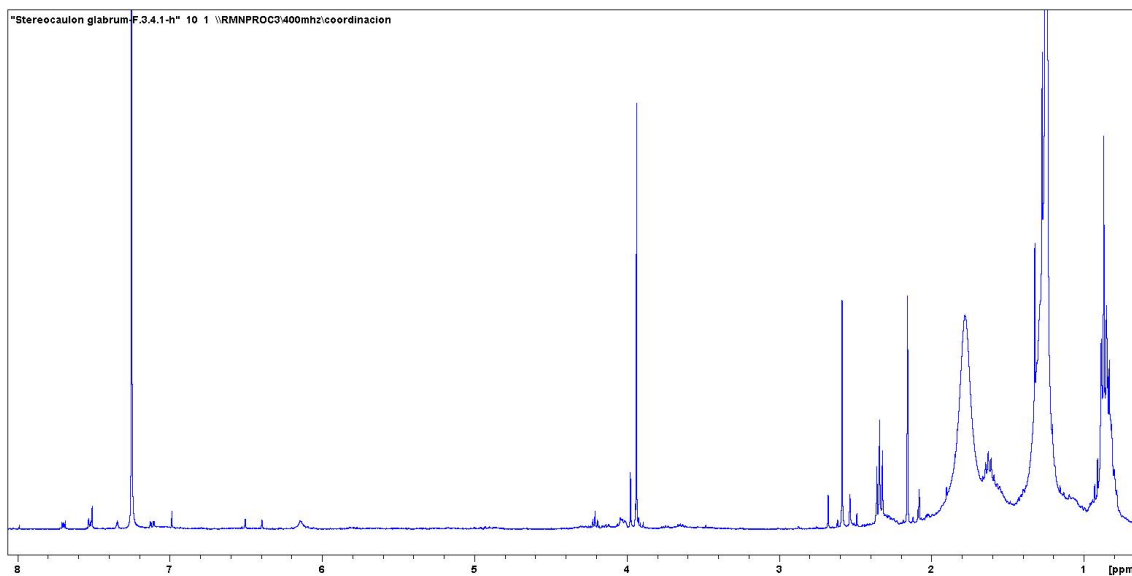


**Figure S9**  $^1\text{H}$  -  $^{13}\text{C}$  HSQC heteronuclear correlation spectrum (500 MHz) of bourgeanic acid.

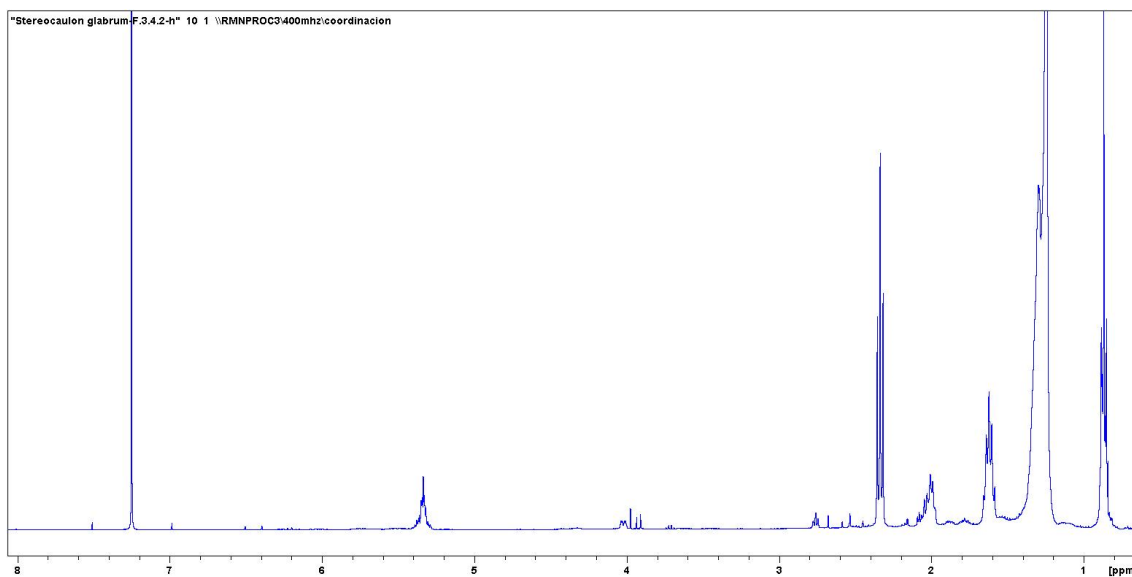


**Figure S10**  $^1\text{H}$  -  $^{13}\text{C}$  HMBC long-range heteronuclear correlation spectrum (500 MHz) of bourgeanic acid.

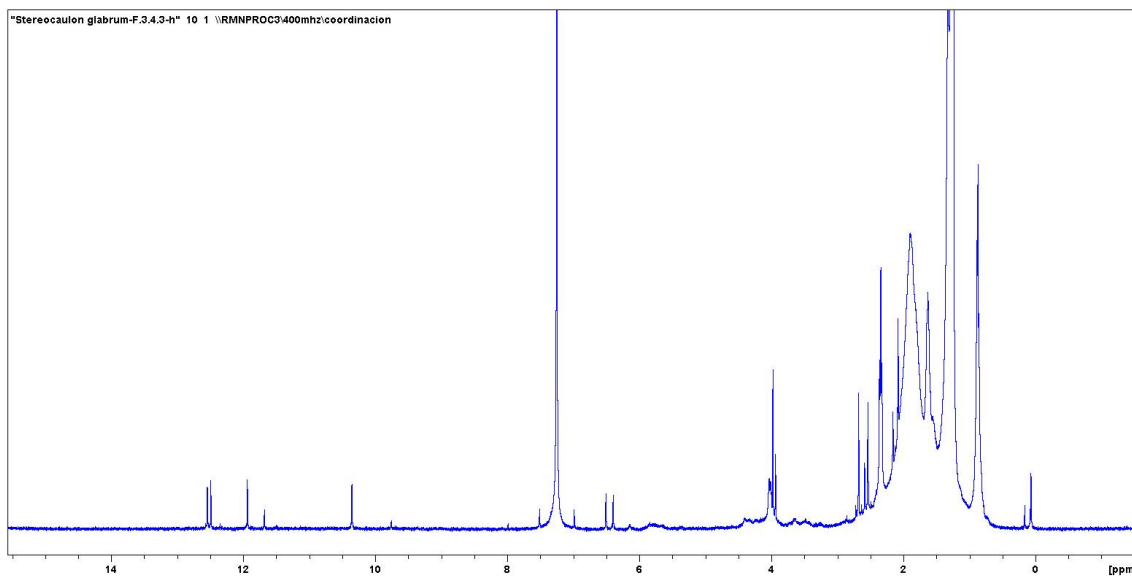
### Section 3. Spectra (NMR) of fraction F<sub>3.4</sub> (HPLC)



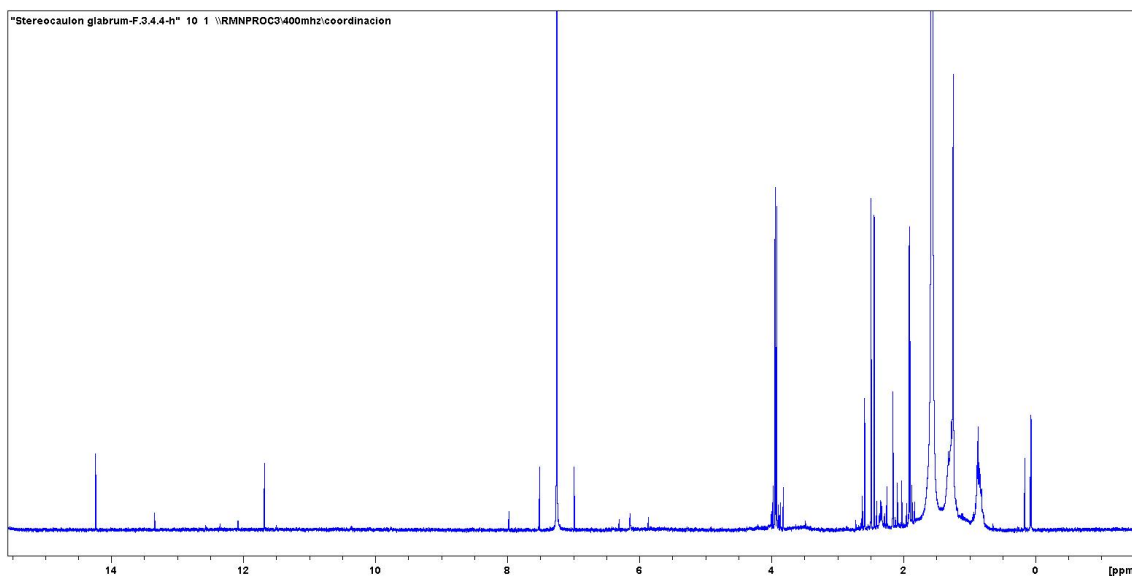
**Figure S11** <sup>1</sup>H – NMR SPECTRUM OF F<sub>3.4.1</sub> FRACTION



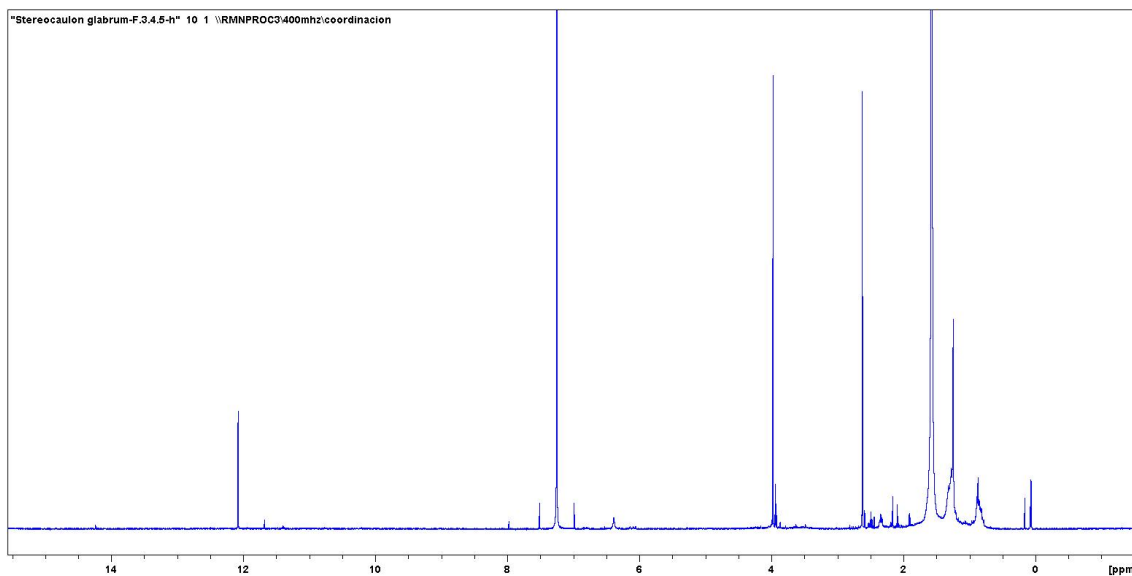
**Figure S12** <sup>1</sup>H - NMR spectrum (400 MHz) of fraction F.3.4.2



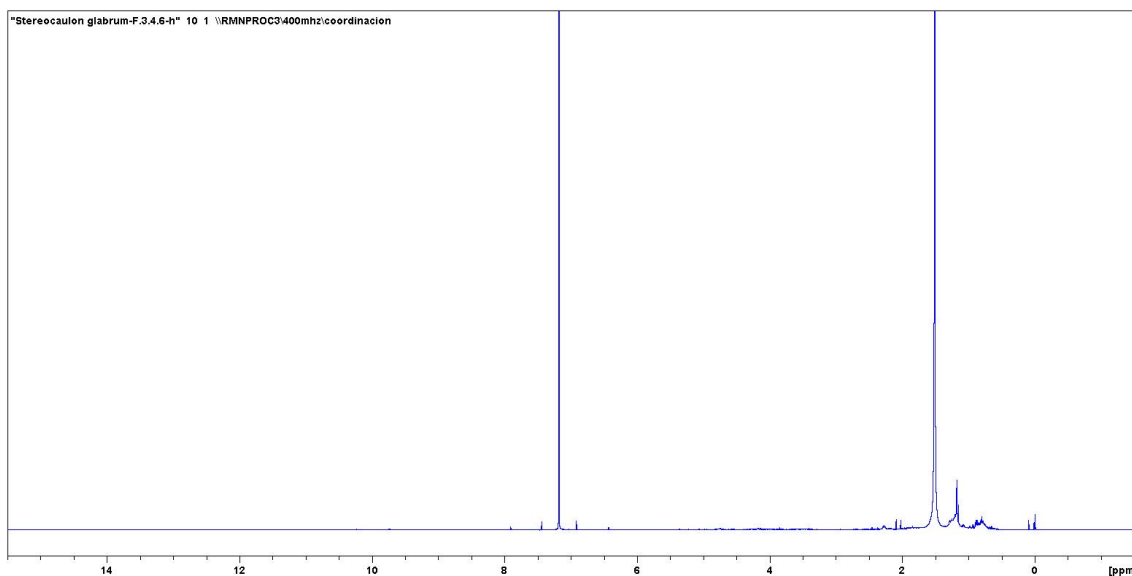
**Figure S13** <sup>1</sup>H - NMR spectrum (400 MHz) of fraction F.3.4.3



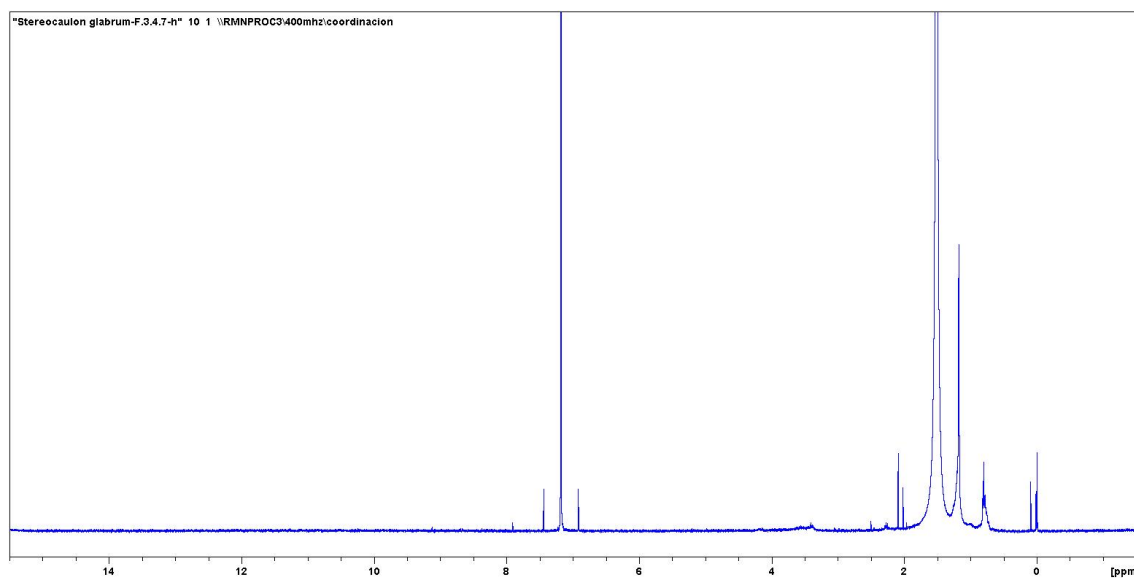
**Figure S14** <sup>1</sup>H-NMR spectrum (400 MHz) of fraction F.3.4.4



**Figure S15** <sup>1</sup>H-NMR spectrum (400 MHz) of fraction F.3.4.5



**Figure S16** <sup>1</sup>H-NMR spectrum (400 MHz) of fraction F.3.4.6



**Figure S17** <sup>1</sup>H-NMR spectrum (400 MHz) of fraction F.3.4.7