

# Hormetic effects of moderate wine drinking : evidence from cross-sectional study

---

**Lukežić, Marina**

**Master's thesis / Diplomski rad**

**2020**

*Degree Grantor / Ustanova koja je dodijelila akademski / stručni stupanj:* **University of Split, School of Medicine / Sveučilište u Splitu, Medicinski fakultet**

*Permanent link / Trajna poveznica:* <https://um.nsk.hr/um:nbn:hr:171:915511>

*Rights / Prava:* [In copyright](#)/[Zaštićeno autorskim pravom.](#)

*Download date / Datum preuzimanja:* **2024-09-21**



*Repository / Repozitorij:*

[MEFST Repository](#)



**UNIVERSITY OF SPLIT  
SCHOOL OF MEDICINE**

**MARINA LUKEŽIĆ**

**HORMETIC EFFECTS OF MODERATE WINE DRINKING  
- EVIDENCE FROM CROSS-SECTIONAL STUDY**

**Diploma thesis**

**Academic year**

**2019/2020**

**Mentor:**

**Prof. Ozren Polašek, MD, PhD**

**Split, July 2020**

# TABLE OF CONTENTS:

<b>1. INTRODUCTION</b> .....	1
1.1 Definition of Hormesis.....	3
1.1.1 Principle of Hormesis.....	3
1.2 Ethanol and Hormesis .....	4
1.2.1 Alcohol promotes Antioxidant Activity .....	5
1.2.1.1 The Nuclear Factor Erythroid 2-related Factor 2 (Nrf2).....	6
1.2.3 Effects of Alcohol on the Cardiovascular System.....	8
1.2.4 Effects of Alcohol on Anti-aging .....	11
1.2.5 The Action of Polyphenols.....	11
1.3 Direct Stimulation Hormetic-like Responses.....	12
<b>2. OBJECTIVE</b> .....	17
<b>3. MATERIALS AND METHODS</b> .....	19
3.1 Study Setting.....	20
3.2 Methods.....	20
3.2.1 Primary and Secondary Outcome Measures .....	22
3.3 Statistical Analysis .....	22
<b>4. RESULTS</b> .....	23
4.1 Differences in Socioeconomic Status .....	24
4.2 Variation in Gender-based Alcohol Consumption.....	25
4.3 Comparison of Cardiovascular Results among Sub-cohorts and Gender .....	29
4.4 Application of Hormesis .....	31
<b>5. DISCUSSION</b> .....	34
<b>6. CONCLUSION</b> .....	37
<b>7. REFERENCES</b> .....	39
<b>8. SUMMARY</b> .....	42
<b>9. SUMMARY IN CROATIAN</b> .....	44
<b>10. CURRICULUM VITAE</b> .....	46

*To my thesis supervisor, Prof. Ozren Polašek for his consistent positive support and mentorship.*

*To my friends, my heartfelt appreciation for their continued encouragement and comradery.*

*To my sister and my brothers, my profound gratitude, for their relentless and unparalleled love.*

*To my grandparents and my Kuma, who nourished me with positive thoughts and nutritious food throughout these last six years.*

*Finally, to my parents, to whom I am forever indebted, for providing me with the opportunities and experiences that have made me who I am. They persistently encouraged me to never stop believing in myself. This chapter in my life would not have been possible if not for them.*

## LIST OF ABBREVIATIONS

ACA - acetaldehyde

ARE - antioxidant-electrophile response element

cAMP - cyclic adenosine monophosphate

CSR - cellular stress response

HDL - high density lipoprotein

LDL - low density lipoprotein

LOAEL - lowest observed adverse effect level

NF-kB - nuclear factor-kappa B

NOAEL - no observed adverse effect level

NO - nitric oxide

NOS - nitric oxide synthase

Nrf2 - Nuclear Factor Erythroid 2-related Factor 2

PKC - protein kinase C

ROS - reactive oxygen species

RSV - resveratrol

TNF-alpha - tumor necrosis factor alpha

VLDL - very low density lipoprotein

## **1. INTRODUCTION**

"Don't drink and drive", "Know your limit", these are familiar warnings in regards to alcohol ingestion. Consumption of alcohol has direct effect on the human body. Drinking a little can make one giddy, overly confident or extremely talkative (1,2). Chronic alcohol consumption remains a significant cause of death (2-4), resulting in approx. 2.5 million deaths each year according to the World Health Organization (2). Alcohol misuse or abuse is the third leading preventable cause of death in the United State (3).

Routine alcohol consumption has been linked to many negative outcomes (2,5-7) as addiction (2,7), metabolic disturbances, nutritional deficiencies (4) and neurological disorders (2,4,6,8). Furthermore alcohol consumption is known to increase the risk of cancer (2,4,7,8), hypertension (2,3,7), stroke (2,7) and liver cirrhosis (2,4,7-9). What if there was the magical amount of wine or beer? Just enough to take the edge off after a hard day of work and have the potential to prevent cancer (10) and boost the immune system to protect one from illness (7,10,11).

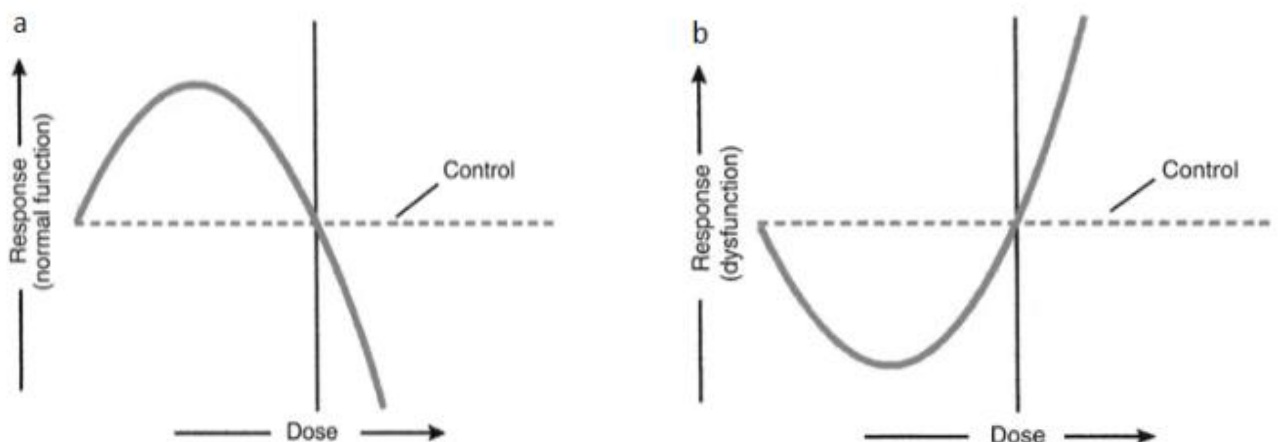
Low to moderate drinking, defined as one drink or less per day for women and two drinks or less per day for men (4,6,7) is associated with reduced overall mortality, (1-3,6-8,12-15) cardiovascular disease (1-4,6-8,11,12,15) and stroke (2,3,6,8,12). Cardiovascular disease and stroke are two of the top leading causes of death in developed countries (6). Alcohol consumption 3-4 days per week is associated with a decreased risk of myocardial infarction among men and women (3,4,6) Antithrombotic characteristics of alcohol lower fibrinogen levels and reduce platelet aggregation preventing myocardial infarction and stroke (3).

Neuroprotective characteristics of moderate alcohol ingestion include cognitive enhancement and prevention of dementia (2,6). In vitro studies have witnessed positive effects on Alzheimer's and Parkinson's disease. Animal models demonstrate that low levels of blood alcohol may prevent depression (2). Alcohol is further believed to pertain immunomodulatory effects (2,11), improving responses to vaccines (2,7), protecting against infection and decreasing incidences of upper respiratory infections (7,11).

It is a widely believed red wine has positive effects on the human body (11). Ingredients in red wine as flavonoids and polyphenols are proposed to inhibit platelet aggregation and thrombosis (2,6,10). Phenolic compounds are believed to be chemoprotective, cardiovascular protective (16,17) and have a positive effect on aging (16).

## 1.1 Definition of Hormesis

Hormesis describes the reaction of the body to a substance, which in high quantities has a harmful effect and in small amounts is beneficial to the body. Producing a biphasic curve that may be either U- or J-shaped (1,5,13-15,18). See Figure 1. In an inverted U-shape curve, response to very low doses of a substance must be equivalent to very high doses (12).



**Figure 1.** Examples of an inverted U-shape curve (a) and J-shaped curve (b) (5)

### 1.1.1 Principle of Hormesis

Hormesis is a common phenomenon in toxicology encountered with many different chemicals and is relatable not only to humans, but to a wide range of organisms including plants and microbes. As the body tries to cleanse itself of the toxic substance, it not only rids itself of the main stressor, but compensates further to repair additional damage (14,15,18).

Mechanisms the body uses include thermoregulation, detoxification, cell proliferation and apoptosis. Other mechanisms include DNA-repair, heat-shock protein synthesis and upregulation of antioxidant response. All these mechanisms result in cell death and regeneration or return to homeostasis (12). The return to homeostasis may leave the cell better able to cope with similar changes in future (12,15). It is hypothesized constant exposure to low levels of toxic substances keeps the cell in a state of alert (12). However the toxic threshold must not be



overshot. The body must have the ability and time to counteract the toxin. Sufficient time and resources are necessary in order for hormesis to occur (14,18). The ideal hormetic experiment would define the NOAEL/LOAEL (no observed adverse effect level/lowest observed adverse effect level) before initiating experiments, however this is not always possible (14). The overcompensation is measured as a percentage (usually measuring 30-60%) rather than an increase of 2-3 fold (14,18). The wide variation in the percentage of overcompensation is believed to be due to genetic heterogeneity (2,18).

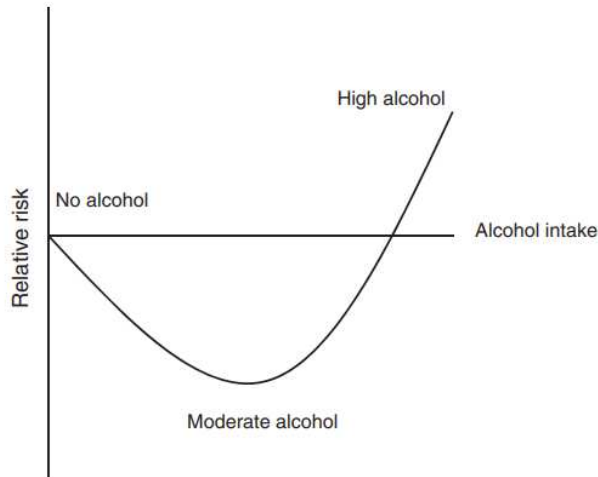
Cellular stress response (CSR) is the reaction of a cell to damage. All organisms have stress proteins that respond to non-specific macromolecular damage. The return to homeostasis is regulated more specifically. Main aspects of the CSR include - the sensing of membrane lipid, protein and DNA damage, redox sensing and regulation, cell-cycle control, macromolecular stabilisation and repair, and control of energy metabolism. In addition, cells can quantify stress and may choose to cause cell death, called apoptosis, when tolerance limits are exceeded (12).

Certain stressors result in a stress response that acts as a buffer against what would otherwise be a harmful agent. Low levels of stress result in the expression of protein repair proteins, for example, heat-shock proteins (12,14) or the elimination of damaged proteins that cannot otherwise be repaired (12). Low levels of stress may also induce DNA repair (12-14) and replication molecules by altering chromatin structure to facilitate repair (12) or altering gene expression to accelerate function (9,12). In addition antioxidant and radical scavenging molecules may increase during low levels of stress (14).

Increased tolerance towards a stress factor after the organism has been exposed to low doses of that stress (stress hardening) and increased tolerance to a stress after preconditioning by another stress (cross-tolerance) are known. Both types of stress are hormetic responses (12).

## **1.2 Ethanol and Hormesis**

Ethanol is suggested to have a low dose excitatory and high dose depressive effect (5,15). Various alcoholic beverages produce a J-shaped curve with 1-2 drinks per day decreasing the risk of diverse diseases, (7,12,13) including coronary heart disease (3,4,6), and mortality (2). See Figure 1, b and Figure 2.

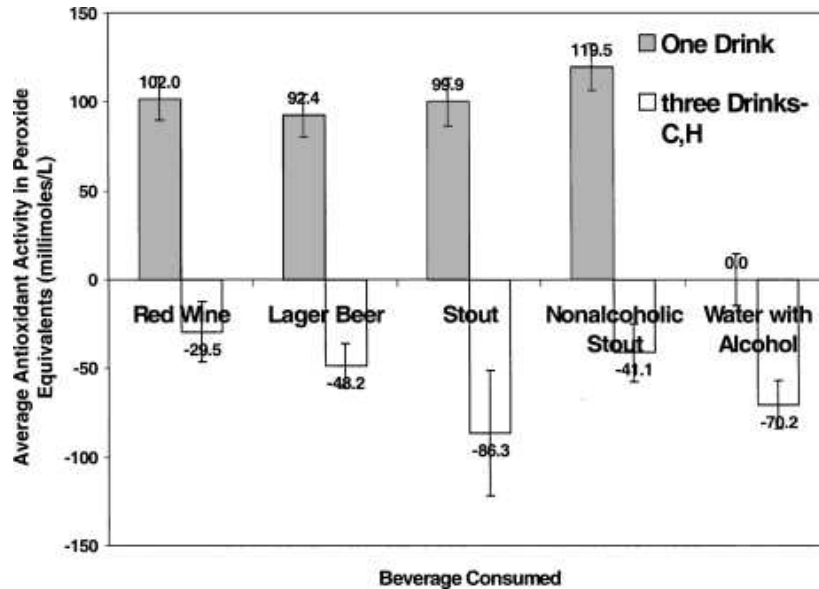


**Figure 2.** Association between the risk of cardiovascular disease and alcohol consumption, producing a J-shaped curve (3)

### 1.2.1 Alcohol promotes Antioxidant Activity

Studies have indicated an increase in plasma antioxidant activity after consumption of various alcoholic beverages. The increase was highest after a single glass of red wine, beer or stout. Non-alcoholic stout contains significant antioxidant activity, suggesting that other substances besides ethanol contribute to antioxidant activity. Antioxidant activity in the example was measured using luminescent assay detecting the amount of photons following addition of a standard amount of peroxide. Antioxidant activity was calculated as the decrease in counts after addition of the beverage samples, See Figure 3 (10). It is hypothesized that phenolic compounds may be largely responsible for the observed antioxidant effect (10,17).

Three drinks increase pro-oxidant activity and thus increase the risk for atherosclerosis, how much of this is due to alcohol is unclear (10). Alcohol is known to produce reactive oxygen species (ROS) (2,6,9,10), such as superoxide and the hydroxyethyl radical (6). Reactive oxygen species are generally considered harmful (6,7,19), elevated levels of ROS cause oxidative stress which has been shown to play a role in several damaging processes including atherosclerosis (7,10), cancer development, diabetes, inflammation (7,19) and toxicity (19). However it has become apparent that controlled production of ROS also participate in a number of normal physiologic phenomena as second messengers in transmembrane signaling processes (6,19). ROS further demonstrate anti-adhesive and anti-inflammatory properties (6).



**Figure 3.** Average plasma antioxidant activities as a function of time after consumption of one or three alcoholic beverages. The counts per minute were obtained with the Lumac Biocounter M2010. The figure shows the average antioxidant or pro-oxidant activity for the different beverages consumed (10).

Various beverages incorporate distinct ingredients (10), such as polyphenols, vitamins and antioxidants (11). The different substances may vary in bioavailability and have different intrinsic antioxidant properties. Red wine is speculated to be better at destroying ROS perhaps resulting in the observed lower average pro-oxidant activity in plasma. The greatest antioxidant effect is observed 30 minutes after red wine or whiskey (10).

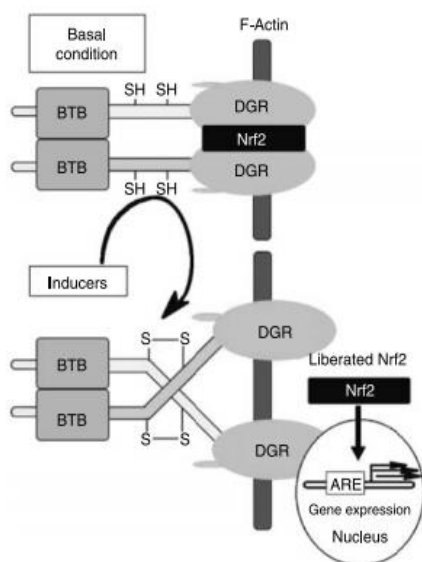
#### 1.2.1.1 The Nuclear Factor Erythroid 2-related Factor 2 (Nrf2)

The Nuclear Factor Erythroid 2-related Factor 2 (Nrf2) is a regulator of cellular resistance to oxidants (19). Alcohol consumption is believed to confer a cardioprotective effect when used in moderation through a NRF2-dependent mechanism (4). The expression of an array of antioxidant-electrophile response element-dependent (ARE) genes regulate the outcomes of oxidant exposure and are controlled by Nrf2 (4,12,16,17,19).

Food phytochemicals are non-essential nutrients found in plants, as polyphenols or flavonoids (20) that can induce Phase II metabolizing enzymes (4,16,17). Phase II metabolizing enzymes are mostly transferases and play an important role in detoxification in drug metabolism

(21). Phase II enzyme genes are regulated by ARE (4,16,17). The leucine zipper Nrf2 transcription factor is targeted by ARE for activation (4,16,17,19). Under basal conditions, Nrf2 resides mainly in the cytoplasm bound to its cysteine-rich, Kelch domain containing partner Keap1, repressing Nrf2 activity (12,19). Phytochemicals can disrupt the Keap1 –Nrf2 complex, resulting in the translation of Nrf2 to the nucleus where transcriptional activity is induced. The mechanism described is shown in Figure 4 (12).

Because of the rich content of thiol groups in the Keap1 protein it is probable that many of the phytochemicals are able to cause modifications through subtle alterations in the redox potential of cells. It may be that hormetic-type effects are created if this subtle alteration in the redox state is maintained, which will result in a permanent up regulation of phase II enzymes (12).



**Figure 4.** The mechanism for the activation of the antioxidant response element (ARE) by phytochemical inducers. BTB, DGR illustrate specific domains of the Keap1 protein (12).

### 1.2.2 Effects of Alcohol on Immunity

Alcohol consumption alters both innate and adaptive immunity in both animal models as well as humans in a dose and time dependent manner (2,7,11). The enhancement of innate immunity seems to be more affected (2). In low doses alcohol increases adherence and phagocytosis of polymorphonuclear leukocytes (5) and reduces inflammation (2,7,11). In high doses alcohol decreases the number of lymphocytes (7,11) and may cause infections (5,7,11) such as pneumonia (5).

Experiments on human monocytes submitted to moderate beer consumption exhibited increased phagocytic (2,7), oxidative burst, and intracellular bactericidal activity (7). Alcohol consumption also impacts cell-mediated and humoral immunity (7,11). Females exhibit a greater sensitivity to alcohol than males (11). Moderate consumption of beer in test subjects resulted in a significant increase in the number of leukocytes, mature CD3<sup>+</sup> T lymphocytes, neutrophils and basophils in women, while only basophils were increased in men (7,11). Moderate beer consumption also enhanced the production of T cells, cytokines IL-2, IL-4, IL-10, and IFN- $\gamma$  (7,11) and reduced IFN- $\gamma$ /IL-10 ratio (7). Modulation of cytokine production via the nuclear factor-kappa B (NF-kB) or NLRP3 pathways appears to be the cornerstone of immunomodulatory effects of alcohol (11).

Modulation of adaptive immunity might be associated with reductions in the incidence and severity of autoimmune diseases such as rheumatoid arthritis, systemic lupus erythematosus, hyperthyroidism and hypothyroidism (2).

Whether alcohol per se has these immunomodulatory benefits or perhaps other characteristics of these beverages, such as total carbohydrate and soluble fiber content, minerals, trace elements and vitamins is still widely debated. It is hypothesized that the following vitamins might act as immunomodulators - phosphorous, silicon, magnesium, potassium, niacin, riboflavin, pyridoxine, folates (11).

### **1.2.3 Effects of Alcohol on the Cardiovascular System**

It is believed that the cardioprotective effect of alcohol (French Paradox) stems from ethanol induced changes (2,3,22). Light consumption of alcohol decreases the risk of diabetes, cardiovascular disease and death (3,5,6). The reduction in mortality is most likely due to a decrease in cardiovascular disease, without a significant increase in other causes of death (5). Cardiovascular benefits have been documented in different genders, races and nationalities (1,6). The risk of coronary heart disease (6,23) is approximately 25-30% lower in consumers of 1 drink per day than abstainers (4,6). Modest alcohol intake is believed to prevent 12–14% of coronary heart disease deaths each year among men aged 30–69 years (4). A decrease in occurrence of ischemic stroke is also linked to alcohol consumption. However the amount of alcohol consumed necessary for the decrease in stroke risk is less than one to two beverages daily and is linked to consumption of one to two beverages per week (6).

Increased performance of vasculature and myocardium are responsible for the

cardioprotective effect (3,6). These changes include lipid metabolism, changes in hemostasis and platelet aggregation (2-6,22), insulin sensitization (3,6,22) antioxidant effects (5,6,22). Other mechanism by which alcohol benefits the cardiovascular system include increased calcitonin gene-related peptide release, arterial vasodilation mediated by nitric oxide (NO) release, expression of cardioprotective proteins, as heat shock protein 70 (3,4,6,22) and lower levels of inflammatory markers as C-reactive protein (3,4,6,7,22). Moderate alcohol consumption is associated with stress-associated anti-inflammatory mechanisms in heart and vasculature (2,3,6). These anti-inflammatory processes involve adenosine receptors (6), IL10 (4), protein kinase C (PKC) (4,6), and a decrease in pro-inflammatory cytokines as Tumor necrosis factor alpha (TNF-alpha), NFkB (7) and IL-6 (6).

Epidemiological evidence has shown that not only red wine, but also white wine, beer and spirits show cardiovascular protective benefits (6). This would conclude that alcohol itself is responsible for the decrease in cardiovascular mortality (3,6). However wine seems to pertain slightly increased cardiovascular benefits, this might be due to increased amounts of polyphenols (2,5,6) which incorporate anti-inflammatory, antioxidant and hypotensive benefits (2). It remains unclear to which amount alcohol contributes to cardiovascular protection and to what degree confounding factors may play a role (2,5,6).

#### Ethanol increases Insulin Sensitivity

Moderate alcohol consumption has been shown to benefit diabetes type II (2). Modest alcohol ingestion is associated with increased levels of adiponectin (3) which is further associated with increased insulin sensitivity (2,3). Low levels of adiponectin are associated with a multitude of cardiovascular disorders. Through its actions on adipose tissue and the liver, high levels of insulin may increase plasma triglycerides and low density lipoprotein (LDL), while decreasing high density lipoprotein (HDL). Thus, part of the beneficial effect of alcohol on HDL may be due to decreased suppression of HDL synthesis by insulin (3).

#### Impact on Cholesterol

Increase in plasma antioxidant activity can protect plasma LDL and very low density lipoprotein (VLDL) from oxidation (4,5,10), thus lowering LDL levels (2,4-6,23) Modification of LDL by acetaldehyde (an alcohol metabolite) increases its removal rate and may explain the reduction of LDL levels (23).

Ethanol is believed to increase HDL (2-6,23) resulting in approximately 50% of its cardioprotective effect (2,4-6,23). Serum HDL levels are inversely related to events resulting from atherosclerosis (3,4). The increase in HDL observed in moderate drinking is believed to stem from an increase in apolipoproteins apo AI and apo AII (4,23). It is important to keep in mind that HDL is also elevated in heavy drinkers (3,23) and alcoholism is a risk factor for coronary events. Higher HDL levels are not always cardioprotective (3,23). Modification of LDL by acetaldehyde (an alcohol metabolite) increases its removal rate and may explain the reduction of LDL levels (23). Ethanol stimulated insulin synthesis is further believed to maintain HDL levels, insulin is believed to decrease the suppression of HDL synthesis (3).

#### Ischemia/Reperfusion Injury Protection

Low dose alcohol consumption may induce several heat shock and antioxidant proteins, which are believed to be cardioprotective in regards to ischemia/reperfusion injury (5,6,12,22). It was recognized that brief ischemia induced shortly before a larger ischemic event reduced the extent and severity of I/R injury, a phenomenon of ischemic preconditioning (4). Decreased infarction size and improved contractile recovery after simulated ischemia-reperfusion injury in animal models were observed (3,4,6). Studies have described anti-stick properties of leukocytes on alcohol pretreated animals, which presented in a biphasic manner. This could prohibit leukocytes docking on tissue after ischemia/reperfusion injury (6).

#### Protein Kinase C Aids in Preserving Mitochondrial Function

Additional cardioprotection is provided by selective activation of protein kinase C and preservation of mitochondrial function. Protein kinase C is a powerful cytoprotectant in myocytes. In mild alcohol preconditioning this isoenzyme localizes to mitochondria three times as frequently and helps preserve organelle integrity (4,6). Stress hardening and cross tolerance are held responsible for this phenomena (12).

#### Nitric oxide (NO) Amplification

Upregulation of nitric oxide synthase seems to be protective in congestive heart failure (6) and myocardial ischemia-reperfusion (4,6). The anti-thrombogenic properties of NO inhibit smooth muscle proliferation, platelet aggregation and monocyte adhesion. Additional

cardioprotective properties of NO include decreased cardiac contractility, decreased coronary resistance, diminished myocardial oxygen consumption and improved metabolic function (6). Moderate alcohol consumption in animal models enhanced post-ischemic myocardial systolic and diastolic function, as well as attenuated the ischemia-induced increase in coronary vascular resistance (4,6). Furthermore an increased vascular relaxation was noted, consistent with upregulation of endothelial nitric oxide synthase (NOS). These effects were attenuated at increased alcohol consumption (6).

### Biphasic Antihypertensive Properties

The effects of alcohol on blood pressure also display a J-shaped curve. Low-to-moderate alcohol consumption has been shown to lower blood pressure in both animal models and humans. These reductions in blood pressure may be related to improved endothelial function, modulated by increased endothelial-derived NO and prostaglandins, pertaining a vasodilator effect on vascular smooth muscle (3).

### 1.2.4 Effects of Alcohol on Anti-aging

Natural aging in itself results in the up regulation of genes that encode for the inflammatory response. Studies have shown anti-aging effects in regards to alcohol consumption (6,13). Aging results in a decrease in adaptation due to a progressive failure in homeostatic regulation and maintenance. It is speculated mild stress produces stress response-induced gene expression, as well as effects pathways of maintenance and repair, thereby prolonging the aging process. Experiments have shown that genes responsible for purine biosynthesis, heat-shock protein, antioxidant defences and immune response genes are commonly expressed. Furthermore genes involved with hormones, cytokines, growth-factor signalling, control of cell cycle and cell death (apoptosis) are altered by aging (12).

### 1.2.5 The Action of Polyphenols

Polyphenols are found in large quantities in red wine and in lesser amounts in other alcohols such as beer. Resveratrol (RSV) along with other polyphenols may be responsible for



many cardioprotective and other health properties of alcohol (2,6,11,16). One should keep in mind that many similarities exist in the action and molecular targets of polyphenols and alcohol (2,6,11), such actions include anti-inflammatory, anti-oxidant, hypotensive (2) and anticoagulative properties (4).

Polyphenols are considered as antioxidants mostly due to chemical properties such as scavenging of free radicals or other indirect effects (16,17). However, depending on the chemical context polyphenols can become pro-oxidant and generate reactive oxygen species (ROS), as peroxide. Data suggest that RSV becomes more pro-oxidative in physiological media (10,16). Defense mechanisms counteracting ROS include autophagy, cell cycle arrest, cellular repair and expression of cellular defense genes (16).

Hormetic effects of oxidative products derived from RSV are driven by activation of Nrf2 (16,17). The nuclear factor like 2 (Nrf2) is responsible for accommodating oxidative stress by oxidative phosphorylation and endogenous pyruvate breakdown, which in turn leads to increased intracellular levels of the potential ROS-scavenger pyruvate.

RSV in hormetic amounts increases intracellular ratio of metabolite couples GSH/GSSG and ATP/ADP (16). Consistent with the ratio of the most relevant GSH/GSSG redox couple, the expression of genes and proteins related to glutathione metabolism was highly elevated, corresponding to significantly raised levels of the potent cellular antioxidant glutathione (16). Activation of the Nrf2 pathway is deemed most responsible for this phenomena (16,17). The overall reduced cellular environment, secondary to the increased pool of endogenous GSH, enables RSV-pre-treated human cells to buffer additional production of ROS (16).

### **1.3 Direct Stimulation Hormetic-like Responses**

#### **Alcohol Metabolites**

The liver constitutes the major site of alcohol metabolism and is therefore very susceptible to ethanol and its products (2,7,9). Acetaldehyde (ACA) is the main metabolite of ethanol breakdown (1-3,7,9) which is responsible for the harmful effects of alcohol such as tissue damage. Alcohol dependence and addiction are also linked to actions of acetaldehyde (2,7), whereas positive effects on the body are the result of direct action of ethanol (2). Acetaldehyde has a key role in the development of liver injury and stimulates antibody responses that further promote liver inflammation and fibrosis (7). Acetaldehyde is also linked

to mitochondrial dysfunction, oxidative stress injury and myocyte apoptosis. Other harmful mechanisms of ACA include altered calcium handling, loss of contractile proteins and excess collagen deposition (3).

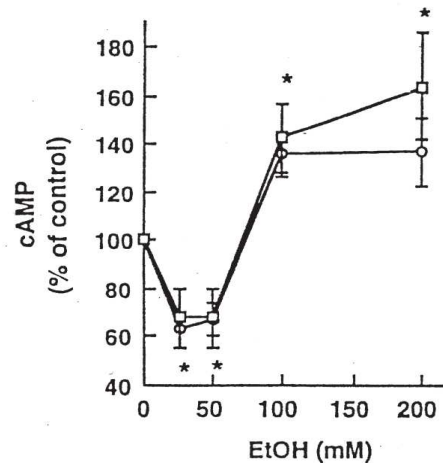
#### Acetaldehyde Action on the Heart

Research has reported biphasic action of ACA on inotropic and chronotropic heart action. Low concentrations of ACA are linked to an increase in heart rate, cardiac output, coronary blood flow and left ventricular pressure via stimulation of  $\beta$ -adrenergic receptors. High concentrations of ACA depress myocardial contraction and reduce intracellular  $\text{Ca}^{2+}$  mobilization which inhibits contraction through voltage-dependent channels. Acetaldehyde might be responsible for myocardial dysfunction associated with elevated ethanol consumption as well as cardioprotective effects at moderate consumption (1).

#### Alcohol effects cyclic adenosine monophosphate (cAMP) production

Both stimulatory and inhibitory responses on cAMP production are described in whole cells exposed to alcohol. It was observed that especially acute ethanol intoxication increases extracellular adenosine concentrations (1,24), proposing that this could be the mechanism affecting cAMP concentrations (1). Large and prolonged elevations of cAMP can also be converted to extracellular adenosine. Alcohol is known to inhibit nucleoside transport in cell membranes, hereby limiting adenosine reuptake into cells (6). Different adenosine receptor subtypes have been identified (24). The A1 receptor is responsible for an inhibitory and A2 receptors for an excitatory effect (1). Ethanol induced sedation, motor incoordination and increase in portal blood flow has been linked to extracellular adenosine acting on A1 receptors (1,24). However the A1 receptor is also believed to play a role in cardioprotection. Data indicate A2 receptor occupancy to be responsible for an anti-inflammatory state (6).

Experiments have been done on hepatocytes with glucagon, which results in a dose dependent increase in cAMP. Administration of constant glucagon and increased ethanol concentrations resulted in a biphasic response with a decrease in cAMP production within a certain range of ethanol appliance (1). See Figure 5.



**Figure 5.** The biphasic effect of ethanol on glucagon receptor cAMP stimulation. Rat hepatocyte cells were treated with constant amount of glucagon and increasing amounts of ethanol (1).

Not all Biphasic Curves illustrate Hormesis

The last two examples describe biphasic reactions and produce J-shaped curves, involve the direct stimulation of different receptors (M). Critics argue that direct stimulation is not a form of overcompensation and holds no temporal component and as such is not an example of hormesis (14). Because of this it can be argued that they are not examples of hormesis, and caution must be paid to all biphasic processes, noting that not all describe hormetic mechanisms (M).

#### 1.4 Problematic Application of Hormesis

Assuming hormesis as an adaptation is an oversimplification of a complex phenomenon (8,14). Caution should be paid in claiming hormesis as generalizable (15). Even if certain low-dose effects are beneficial it would still be dangerous to increase environmental exposures to toxic and carcinogenic agents (2,8,15,18).

Hormesis is mostly based on empirical observations and little is known about the underlying mechanisms of action (2,3,6-8,12,13,23). Furthermore stimulatory responses are not always beneficial, some may be harmful. Effects of a certain substance must include all effects, not just the positive ones (8,9,15). One must not ignore harmful effects that are induced by a

different mechanism at the same or lower dose exposure (6,8,15).

Toxicologic studies rarely have an adequate number of doses, proper dose spacing, a temporal component and appropriate endpoint selection (7,11,14). Data shown from such studies is often of a single time point (7,14). Without the temporal component it is difficult to tell whether the response resulted from direct stimulation or overcompensation. A lot of research defines hormesis as low-dose stimulation followed by high-dose inhibition, not differentiating the two. It can be argued that not all biphasic-dose response curves actually represent hormesis. Further, direct stimulation phenomena often do not exhibit toxic effects at high doses, another counterargument for hormesis (14).

Critics argue that the widespread occurrence of U-shaped curves represents biologic optimization and pertains only a causal link to hormesis (14). U-shaped curves have been observed in many different systems under specific physiologic conditions (14,15). It can be argued that the response is more appropriately described as 'non-monotonic' (8).

It is difficult to determine the distance from the maximum stimulatory response to the NOAEL. This depends on the number of doses, their variability in response and the estimated value of the NOAEL (14). Furthermore sample size, data variability, endpoint measured, duration of exposure, route and rate of exposure affect NOAEL. Examples of hormesis could be artifacts of a small sample size or data variability (15). Furthermore dose response latency and preconditioning must be considered (18).

Susceptibility and exposure are very different among people over the course of a lifetime (2,6,8,9,11,12,23). Physiological differences and differences in health status can influence susceptibility (2,6,8,11,12,15). Interindividual variation includes high and normal risk variation. The percentage of population believed to be high-risk is 5-15%. The response can be positive, neutral or harmful. Persons will not be equally protected or gain benefits from the same exposure (18). Often the moment of exposure can be equally as important as the dose (12,15). Environmental and workplace exposure can alter the low-dose response of a single agent (12). It is also important to consider the lifetime effect (6,15), many cancers and other diseases do not appear until later in life (15).

Exposures in the real world do not occur to one substance but to many substances that interact with each other or can affect different steps of multistage disease processes. It is also unknown what effect interacting substances may have. The mix of chemicals a person is exposed to can vary depending on their work, where they live or what they drink and eat (8,18). Confounding variables must be considered when hormetic effects are being discussed (6,11,15). It is important to keep in mind that different compounds can affect the same target tissue by

similar or different mechanisms of action (8).

It is also important to keep in mind that especially in regards to alcohol many researchers might have conflicts of interest affecting study results (6,11,15).

## **2. OBJECTIVE**

**Aim:**

The aim of this study was to investigate the existence and magnitude of the hormetic benefit of moderate alcohol consumption on cardiovascular system parameters.

Following variables were considered:

1. The type of alcohol consumed - white wine, red wine, beer, bevanda (red wine and water) and hard liquor.
2. The amount of alcohol consumed on a daily basis.
3. The cardiovascular system measurements, including peripheral systolic and diastolic blood pressure, central systolic and diastolic blood pressure and heart rate.

**Hypothesis:**

1. Hormetic effects can be detected on both peripheral and central cardiovascular parameters.
2. We assume to detect cardiovascular benefits with consumption of all alcoholic beverages. However, due to the combined effect of both ethanol, polyphenols and flavonoids we believe the greatest effect will be observed with red wine.
3. We estimate the observed hormetic effects to occur at 1-2 drinks per day.

### **3. MATERIALS AND METHODS**



### 3.1 Study Setting

This thesis is based on data from the 10,001 Dalmatians study and incorporated all available sub-cohorts. The final sample size for this analysis was 4,850 subjects. The subjects were invited into the study via direct postal invitations, referrals from their general practitioners or responders to radio announcements. Eligible candidates were all persons over age eighteen willing to participate. No specific exclusion criteria were established. The samples consist of three sub-groups. The first subgroup includes inhabitants of the island Vis, the second subgroup are citizens living on the island Korčula and the third subgroup refers to the population in the city of Split. The last subgroup served as the mainland control for the islands. Prior to the study, all subjects were thoroughly educated on the protocol and goals of the study. Each participant was further provided with a pamphlet. Informed consent was given by all subjects. The study was approved by the Ethical Board of the Medical School of the University of Split. Some additional boards also approved the study (003-08/11-03/0005).

### 3.2 Methods

Data used in this study was acquired via the cardiovascular data block, general data and survey-based response. The cardiovascular data block provided the cornerstone of information and will be the principal focus of this study.

Analyzed variables included: a) peripheral systolic blood pressure, b) peripheral diastolic blood pressure, c) central systolic blood pressure, d) central diastolic blood pressure, and e) heart rate.

Blood pressure measurements were performed adhering to the following protocol (extracted from the technical documentation of the study):

*The subject should be seated in a quiet room at a comfortable temperature, his/her arm should not be constricted by clothing, and he should not have taken exercise, been exposed to cold, eaten or smoked for half an hour prior to the recording. He should not have changed his posture for five minutes prior to the recording. The arm (either left or right) is supported comfortably at the vertical level of the fourth intercostal space at the sternum ('heart level') at an angle of*

*between 0° and 45° from the trunk. The pressure cuff with bladder for adults must be used. It is applied closely to the upper arm, with its lower border about 2.5 cm above the elbow. For the measurement of blood pressure, rapidly inflate the cuff to a pressure of about 30 mm Hg above that at which the radial pulse can no longer be felt. Place then the stethoscope lightly over the brachial artery in the cubital fossa and immediately allow the mercury column to begin to fall, at a rate of 2mm/s. The first perception of sound is taken as the level of the systolic pressure. The diastolic pressure is taken as the point at which the sounds disappear. Deflate then the cuff to zero pressure. Repeat the measurement of blood pressure two times during an examination and document the readings.*

Adhering to the above protocol, both systolic and diastolic pressures were measured twice at each appointment. This was done in order to minimize the possibility of a “white coat” response. Additionally, blood pressure devices were inspected on a weekly basis in order to prevent inaccurate measurements.

Heart rate was extracted from ECG recordings. Recordings were performed using a portable Mortara ELI 300 digital ECG. Lastly, the central pressures were measured using the SphygmoCor. The device operates via a blood pressure cuff that measures brachial blood pressure as well as the pulse waveform. The subjects were asked to lie down for at least five minutes before the measurements. The measurements took place on radial and femoral artery, but only central blood pressures were used in this study.

Additionally, five survey-based questions were utilized in order to determine the type of alcoholic beverage consumed. Participants could choose among white wine, red wine, bevanda (a mixture of red wine and water), beer and hard liquor. The amount of alcohol ingested on a daily basis was noted in dl. This data was further supplemented by the age and gender, and assigned a cohort. In order to offset a possible social acceptability bias, EPQ-R lie scale was introduced into the survey. This construct was entered into the analysis in an attempt to examine if tendency towards lying might be a significant predictor of the results. In order to adjust for the possible confounding variables, we also introduced years of schooling (number of formal education years any person had undertaken) and a composite material index, consisting of equally weighted sum of binary responses to 16 questions regarding material possession (ie. including possession of a boat, TV, additional apartment or a vacation home, wooden floors, art objects, over 100 books, etc). Both years of schooling as well as material status were validated in the target population.

### **3.2.1 Primary and Secondary Outcome Measures**

The primary outcome measure of the study was defined as the existence of an hormetic curve on cardiovascular health. The secondary outcome measure would present as differences on cardiovascular health across various types of alcohol.

### **3.3 Statistical Analysis**

Categorical data was analyzed using the chi-square test. The numerical data was analyzed either with the analysis of variance (ANOVA) and LSD post-hoc test, or in some cases using t-test (for some pairwise testing). We assumed that the existence of possible hormetic effects would be presented by the specific shape of the curve illustrating cardiovascular parameters depended on the amount of alcohol consumed. The curve was assumed to demonstrate the following pattern: no effect for non-drinkers, beneficial effects for moderate consumption and harmful effects for the heavy consumption of alcohol. Since no analytic model fit this type of curve, we performed visual inspection and described the overall pattern, rather than statistical testing of the ideal curve shape. The most important source of information was linear regression, where age, sex, years of schooling and material status were used in the initial analytic step. After fitting of these four covariates, we extracted residuals and used them in subsequent analysis, this enabled us to compare the groups directly. In the last analytic step, we split the data according to gender in order to examine whether an hormetic effect might be more pronounced in any of the two genders. All the analyses were performed in SPSS (IBM SPSS, ver 21), with significance set at  $P < 0.05$ .

## **4. RESULTS**

## 4.1 Differences in Socioeconomic Status

The study included 4,850 subjects, divided into five cohorts (Table 1). In total, there were 1,845 men and 3,005 women, which indicated a significant gender composition across all analyzed cohorts ( $P=0.014$ ). Analyses concluded that the Island of Vis, the first sub-cohort, had the least surplus of women. The remaining sub-cohorts had similar gender composition (Table 1). The average age across sub-cohorts was over 50, with the youngest sample composition in Split and the oldest on Vis (Table 1). Comparison of socioeconomic indices yielded the expected result, with the best result in Split. On average, the Split sub-cohort had more years of schooling, and scored highest in all three socioeconomic indicators, subjective and objective material status, as well as compound index (Table 1). In terms of island-island comparisons, two sub-groups in Korčula were in general following the same pattern (Korčula and Smokvica), while the rest were significantly different (Table 1).

**Table 1.** Comparison of the basic characteristics of five analyzed sub-cohorts

	Vis	Korčula (K)	Split	Korčula (S)	Korčula (B)	P (pair-wise differences)
			Gender			
Men; n (%)	427 (41.5)	345 (35.6)	395 (39.0)	334 (39.1)	344 (34.9)	
Women; n (%)	602 (58.5)	624 (64.4)	617 (61.0)	521 (60.9)	641 (65.1)	0.014
						<0.001
Age (years); average±SD (min-max)	55.8±15.6 (18-91)	56.3±14.2 (18-98)	50.3±14.5 (18-85)	53.6±16.6 (18-92)	52.8±16.5 (18-98)	(ns pairs 1-2, and 4-5)
Years of schooling; average±SD (min-max)	10±3.6 (0-22)	10.9±3.4 (1-22)	13.2±3.1 (0-26)	10.9±3.3 (1-24)	11.2±3.1 (0-21)	<0.001 (ns cohorts 2 vs 4)
Subjective material status; average±SD (min-max)	3.1±0.8 (1-5)	3.2±0.8 (1-5)	3.4±0.7 (1-5)	3.2±0.8 (1-5)	3.2±0.7 (1-5)	<0.001 (cohort 3 best)
Objective material status; average±SD (min-max)	-*	3.2±1.5 (1-6)	4.3±1.5 (1-6)	3.3±1.5 (1-6)	3.6±1.4 (1-6)	<0.001 (cohort 3 best)
Compound material status index; average±SD (min-max)	9.5±2.7 (1-16)	10.5±2.8 (1-16)	11.3±2.5 (1-16)	10.3±2.6 (2-16)	10.0±2.6 (1-16)	<0.001 (ns cohorts 2 vs 4)

\*wasn't measured in this population

## 4.2 Variation in Gender-based Alcohol Consumption

Analysis of the gender-stratified reported alcohol intake suggests a rather interesting pattern, marked by the interplay between cohort and gender effects (Table 2). Most notably, men reported drinking beer nearly similarly in all cohorts. Consumption of white wine by men was most commonly reported on Vis, where concomitantly the lowest rate of bevanda was consumed. Red wine and hard liquor intake by the male gender was reported in similar amounts across all sub-cohorts.

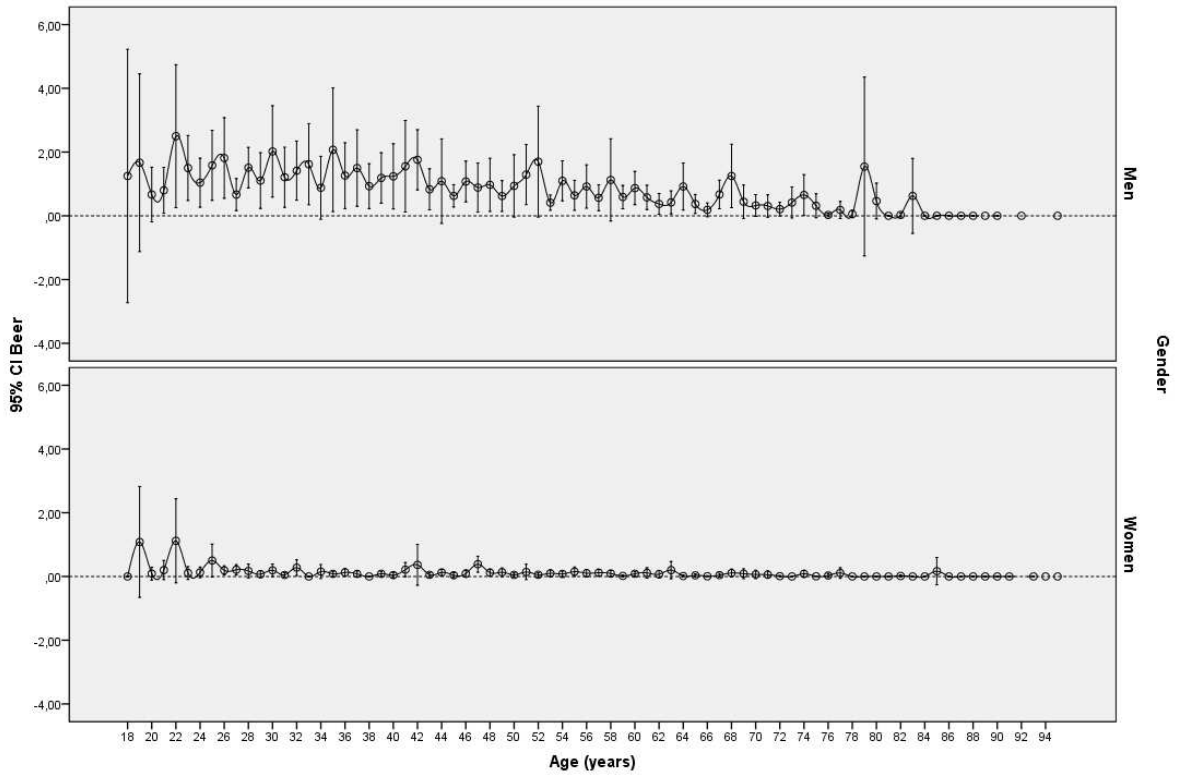
Women of all sub-cohorts reported similar ingestion of beer. More white wine was consumed by women on Vis compared to other locations. Compared to the other cohorts nearly twice the amount of red wine was consumed by the female gender in Split. The women of the sub-cohort in Korčula (K) drank the most bevanda. Consumption of hard liquor was almost identical in all five locations (Table 2).

Gender comparison of beverage type and amount revealed the least difference on Vis, while Korčula (S) expressed the most variation (Table 2). Further, when all samples were pooled, the gender comparisons yielded significant differences for all alcohol types, significant at the level of  $P < 0.001$ .

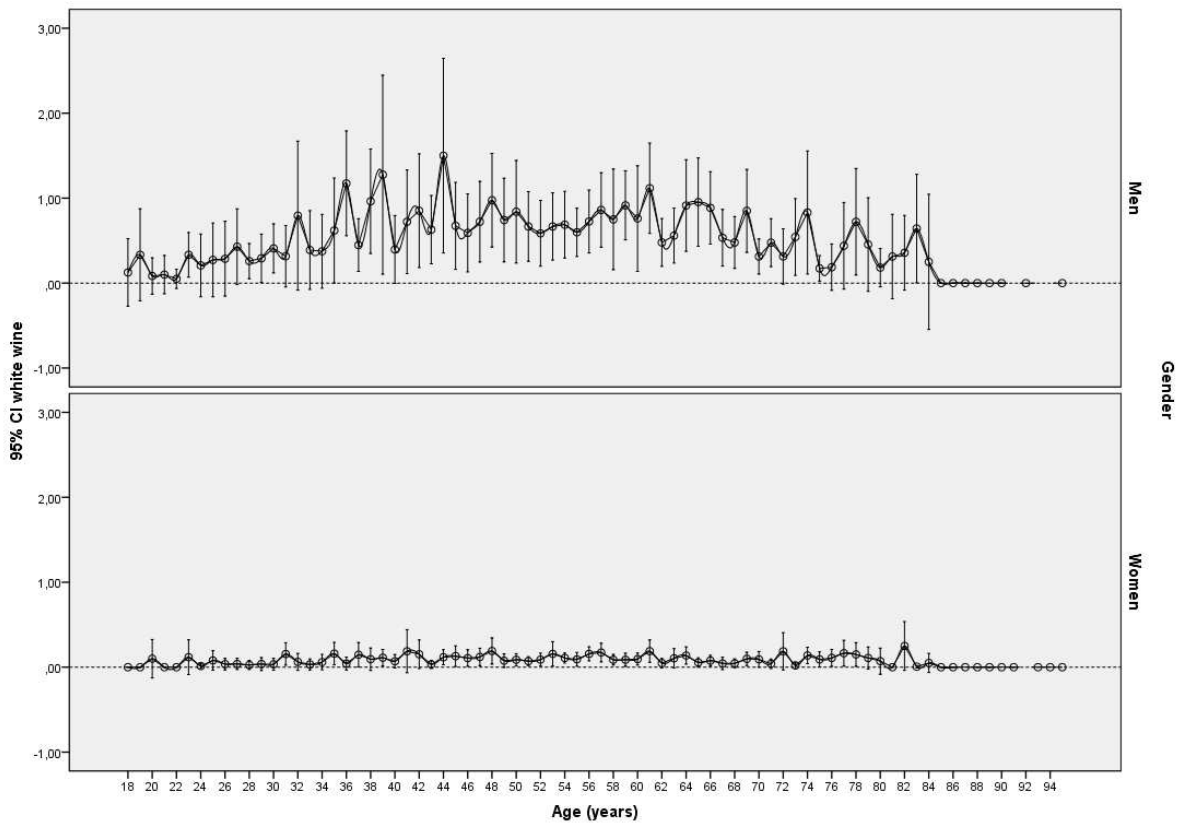
Analysis of the age profile for each of the alcohol types enjoyed indicated a very interesting result. Beer was most commonly enjoyed in younger men, with a steady decline towards older age. In women, drinking beer was mostly reported by the younger age groups, with virtual lack in the elderly (Figure 6). White wine shows a peak in elderly men and follows a more or less constant, low consumption pattern in women of all ages (Figure 7). A similar pattern was observed for red wine, with average greater ingestion of red wine in women (Figure 8). However, in both sexes, bevanda was the most frequently consumed beverage (Figure 9). Lastly, drinking hard liquor was reported by men of all ages, while in women it was almost exclusively restricted to the younger age groups (Figure 10).

**Table 2.** Comparison of the reported alcohol consumption in five sub-cohorts

	Vis	Korčula (K)	Split	Korčula (S)	Korčula (B)	P
Men						
Beer	0.82±1.99 (0-11)	0.72±1.69 (0-14)	0.96±2.07 (0-20)	1.08±2.82 (0-30)	0.67±1.75 (0-20)	0.055
White wine	1.12±1.70 (0-15)	0.43±1.14 (0-10)	0.32±0.77 (0-5)	0.80±1.52 (0-14)	0.49±1.15 (0-7)	<0.001
Red wine	0.38±0.69 (0-3.5)	0.50±1.14 (0-7)	0.57±0.98 (0-7)	0.37±0.9 (0-6)	0.43±1.33 (0-10.5)	0.115
Red bevanda	0.38±1.10 (0-10)	1.55±2.26 (0-10.5)	0.52±1.35 (0-10)	0.67±1.65 (0-10)	1.25±2.59 (0-20)	<0.001
Hard liquor	0.03±0.16 (0-2.1)	0.02±0.07 (0-0,5)	0.05±0.21 (0-3.5)	0.05±0.23 (0-2.5)	0.04±0.19 (0-3)	0.089
Women						
Beer	0.15±0.82 (0-15)	0.10±0.58 (0-10)	0.11±0.59 (0-10)	0.1±0.42 (0-4)	0.08±0.72 (0-14)	0.493
Gender difference	<0.001	<0.001	<0.001	<0,001	<0.001	
White wine	0.20±0.48 (0-4)	0.09±0.41 (0-5)	0.04±0.22 (0-2)	0.11±0.33 (0-3)	0.05±0.25 (0-2.8)	<0.001
Gender difference	<0.001	<0.001	<0.001	<0.001	<0.001	
Red wine	0.12±0.37 (0-2.5)	0.12±0.36 (0-4)	0.24±0.52 (0-4)	0.13±0.50 (0-7)	0.08±0.3 (0-3)	<0.001
Gender difference	<0.001	<0.001	<0.001	<0.001	<0.001	
Red bevanda	0.24±0.75 (0-7)	0.34±0.84 (0-8)	0.18±0.56 (0-5)	0.2±0.64 (0-9)	0.30±1.12 (0-17.5)	0.003
Gender difference	0.013	<0.001	<0.001	<0.001	<0.001	
Hard liquor	0.01±0.07 (0-1.4)	0.01±0.02 (0-0.3)	0.01±0.13 (0-3)	0.01±0.07 (0-1)	0.02±0.11 (0-1.5)	0.036
Gender difference	0.004	<0.001	0.004	<0.001	0.054	-

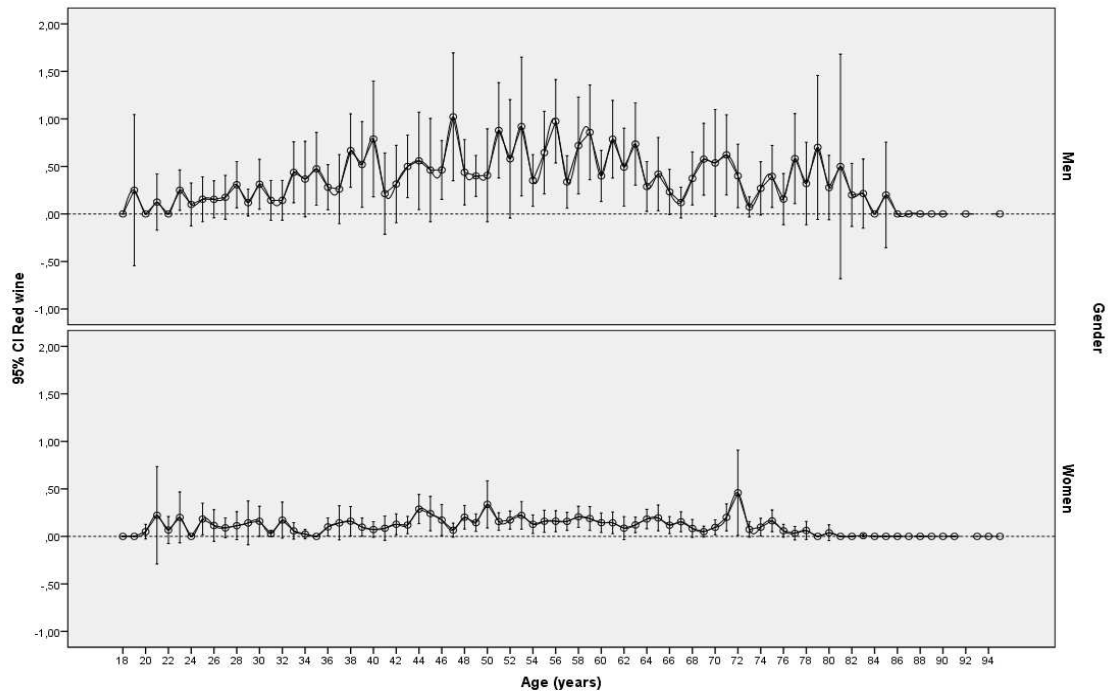


**Figure 6.** Age and gender profile for beer consumption

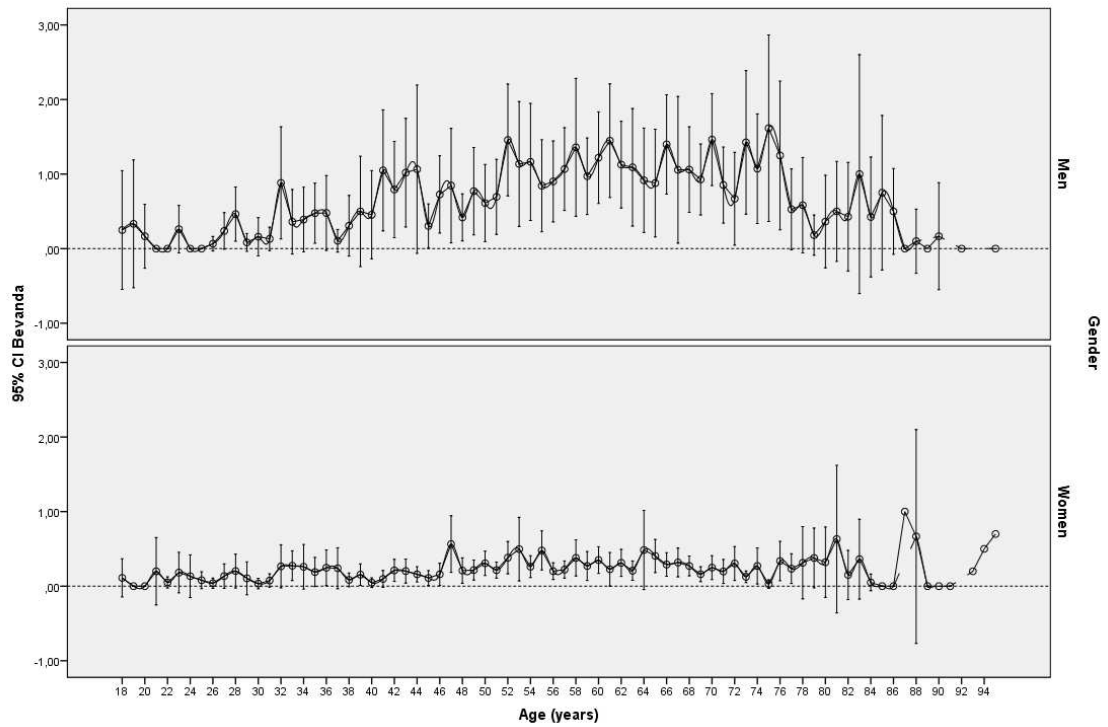


**Figure 7.** Age and gender profile for white wine consumption

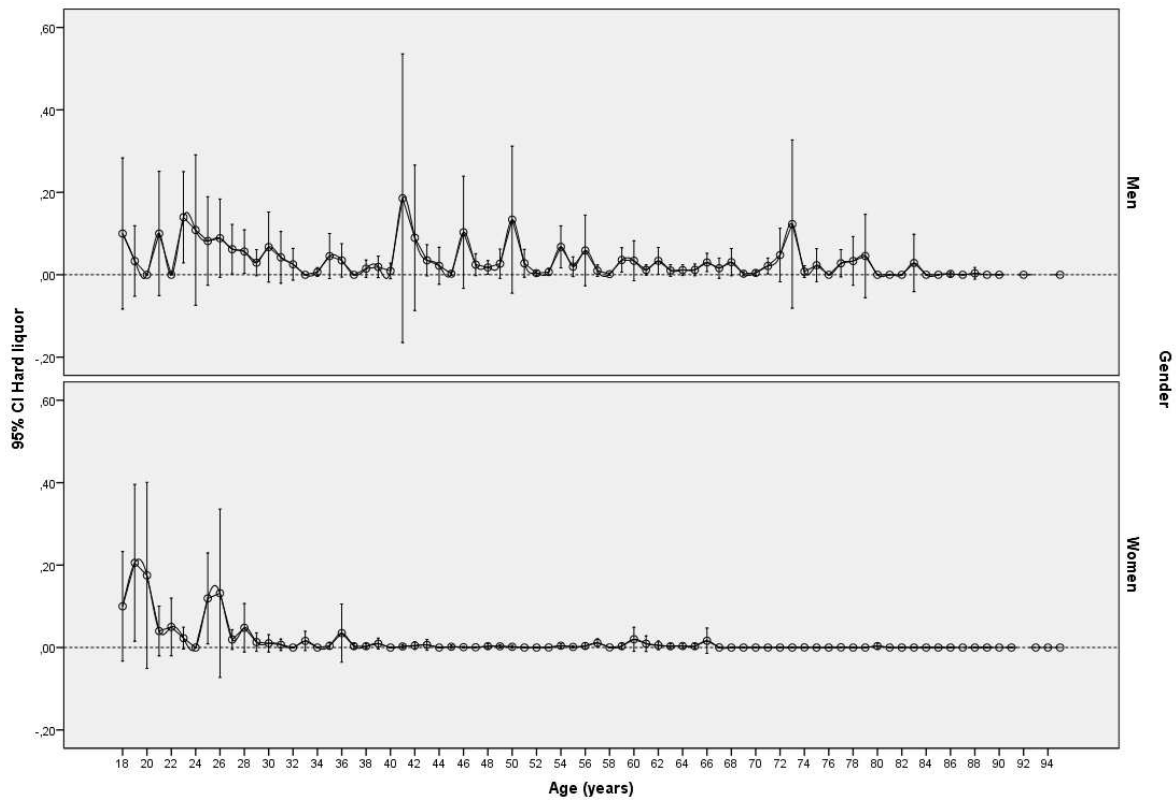




**Figure 8.** Age and gender profile for red wine consumption



**Figure 9.** Age and gender profile for bevanda consumption



**Figure 10.** Age and gender profile for hard liquor consumption

### 4.3 Comparison of Cardiovascular Results among Sub-cohorts and Gender

Comparison of cardiovascular indices revealed a fair degree of diversity (Table 3). Significant differences were detected for all indices in men, except central diastolic pressure ( $p=0.829$ ), which was similar across the analyzed cohorts (Table 3). Similar findings were also recorded in women ( $p=0.192$ ).

The majority of gender-based differences were observed in systolic and diastolic blood pressure. A lesser extent of variation was observed in central pressures. Heart rate remains the one variable that did not exhibit gender-related significant differences (Table 3).

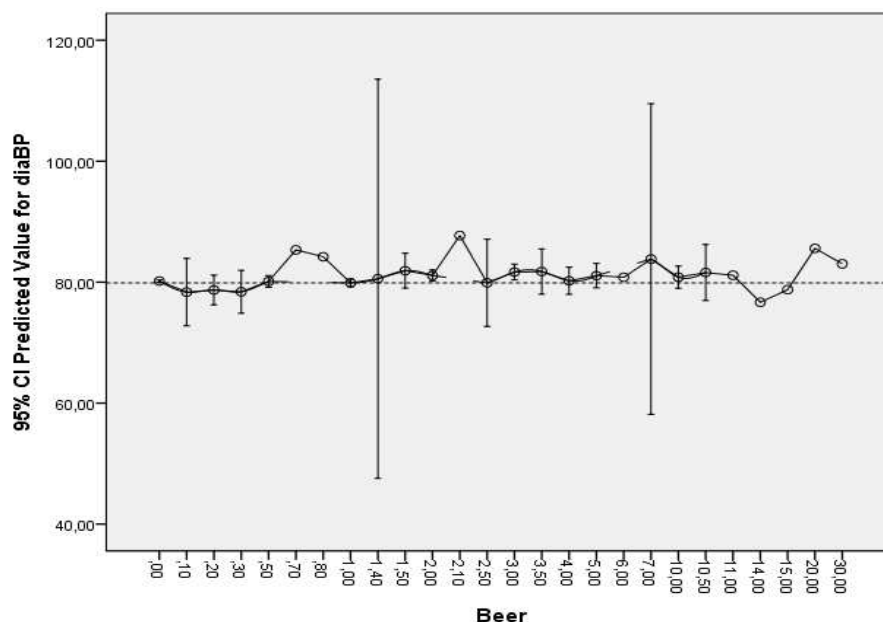
**Table 3.** Comparison of the cardiovascular indices in five sub-cohorts

	Vis	Korčula (K)	Split	Korčula (S)	Korčula (B)	P
<i>Men; average±SD (min-max)</i>						
Systolic BP (mmHg)	138.3±20.9 (95-225)	142.3±18.7 (103-207)	132.7±16.5 (98-186)	134.7±15.6 (102-200)	134.3±15.3 (100-190)	<0.001
Diastolic BP (mmHg)	82.1±11 (56-130)	83.5±8.7 (59-113)	79.7±10 (55-112)	82.3±8.8 (55-110)	83±8.7 (60-120)	<0.001
Central systolic BP (mmHg)	141±25.2 (92-195)	124.2±18.6 (81-195)	123.7±16.6 (88-189)	123.7±15.9 (87-181)	141±25.2 (92-195)	<0.001
Central diastolic BP (mmHg)	85.1±9.1 (66-97)	84.8±9.0 (66-107)	84.3±8.9 (64-108)	84±9.4 (51-109)	84±8.7 (60-121)	0.829
HR (beats per minute)	66.9±12.1 (49-103)	66.8±11.7 (44-109)	67.8±15.4 (44-99)	64.2±10.9 (40-98)	65.8±13.5 (51-102)	<0.001
<i>Women; average±SD (min-max)</i>						
Systolic BP (mmHg)	136.9±24.8 (90-225)	136.9±22 (93-215)	125±18.3 (92-202)	129.3±17.1 (90-200)	126.4±16.1 (90-200)	<0.001
Gender difference	0.371	<0.001	<0.001	0.003	<0.001	-
Diastolic BP (mmHg)	79.3±10.2 (55-112)	80±9.6 (58-111)	74.8±10.1 (54-112)	78.7±9.4 (50-110)	79.1±9.2 (45-120)	<0.001
Gender difference	<0.001	<0.001	<0.001	<0.001	<0.001	-
Central systolic BP (mmHg)	147±23.7 (91-196)	125.3±20.9 (88-175)	120.3±17.1 (80-179)	117.6±16.7 (80-189)	147±23.7 (91-196)	<0.001
Gender difference	0.033	0.357	0.227	<0.001	0.419	-
Central diastolic BP (mmHg)	79.9±10.8 (53-102)	80.2±10.1 (54-114)	81.3±11.6 (55-107)	79.8±9.6 (50-111)	79.8±9 (59-120)	0.192
Gender difference	0.098	0.021	0.039	0.001	0.006	-
HR (beats per minute)	66.7±10.8 (52-98)	68.1±11.2 (52-99)	68.5±10.9 (50-100)	68.3±13.9 (44-99)	66.4±9.9 (42-104)	<0.001
Gender difference	0.236	0.676	0.689	0.261	0.715	-

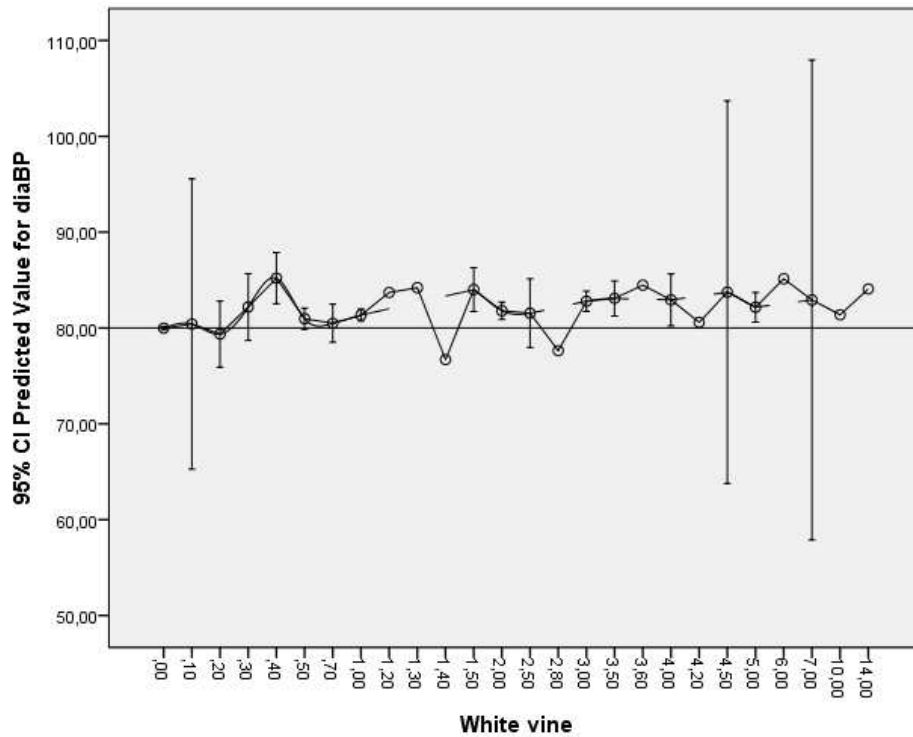
#### 4.4 Application of Hormesis

In order to measure hormesis, the linear regression residuals model was used. This model adjusts the cardiovascular variables according to the effects of age, sex, education and material status. Linear, quadratic and cubic fit of the residuals was calculated and then compared to the amount of alcohol consumed. This way alcohol types illustrating any non-zero significant patterns perhaps indicating hormesis (initial decline, followed by the incline of the fitted curve) could be detected. This step concluded that diastolic blood pressure was the only variable perhaps demonstrating this biphasic action.

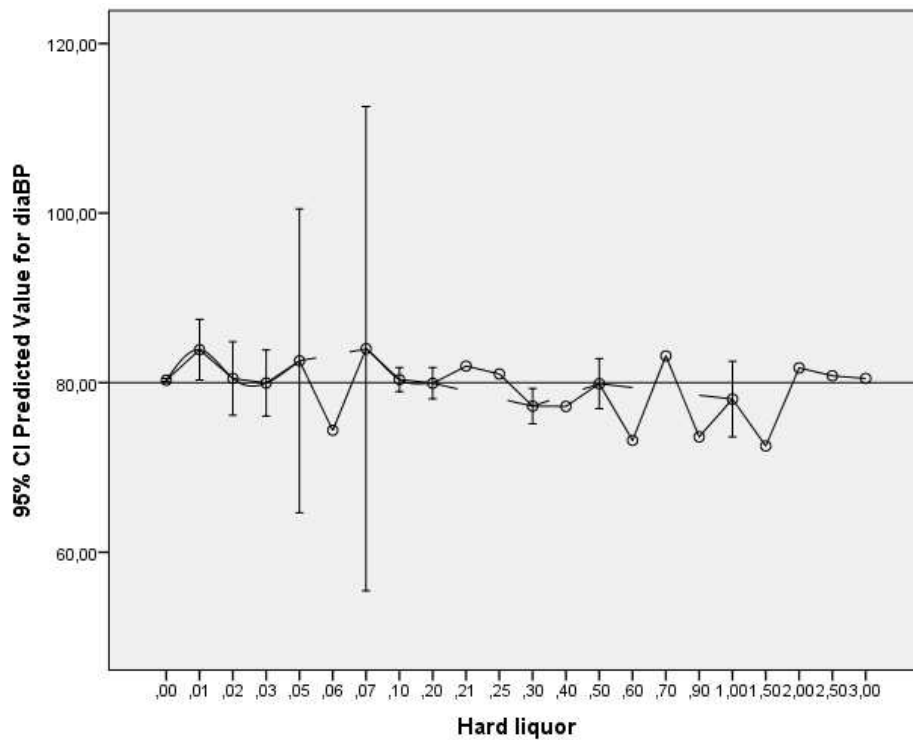
Analysis of beverage type showed no favorable curve contour for beer, white wine or hard liquor (Figures 11-13). However, a very low intensity hormetic effect could be observed for red wine and bevanda (Figures 14, 15). The most significant detectable decrease in diastolic blood pressure was -1.3 mmHg for red wine and -1.1 mmHg for bevanda, respectively. Excessive consumption of red wine resulted in a 3.6 mmHg increase in diastolic blood pressure and 4.6 mmHg increase in bevanda, respectively. Notably, the deflection point at which the hormetic effect was lost was much lower than predicted; they were consistently at a level of 0.7 units weekly for red wine or 1.4 units weekly for bevanda, corresponding to 1 dL of red wine on a daily basis.



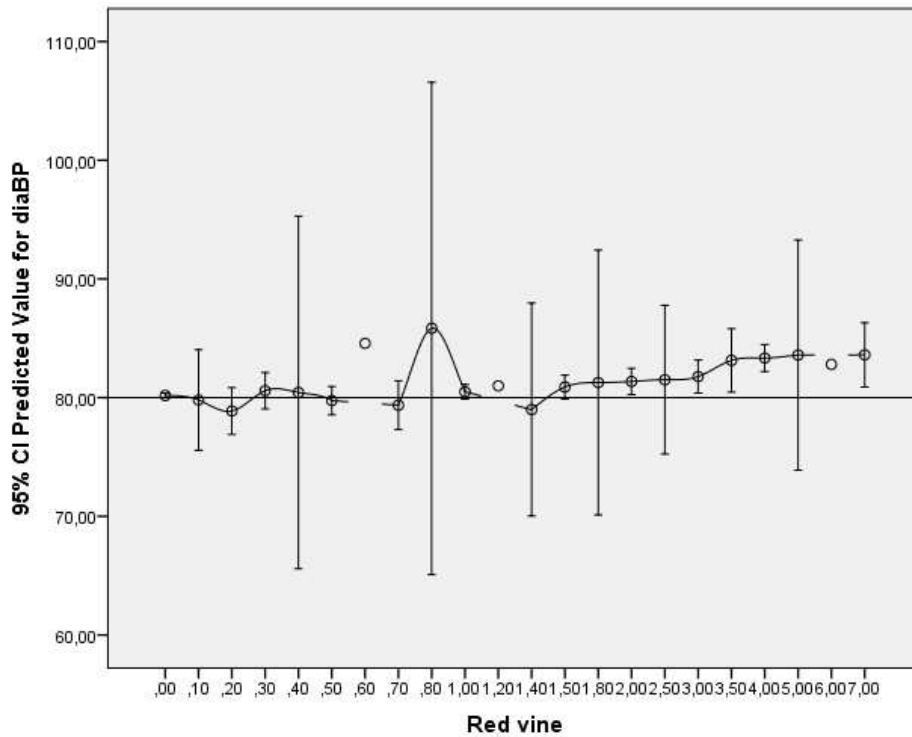
**Figure 11.** Fitting of the adjusted predicted values of diastolic blood pressure for the effects of beer



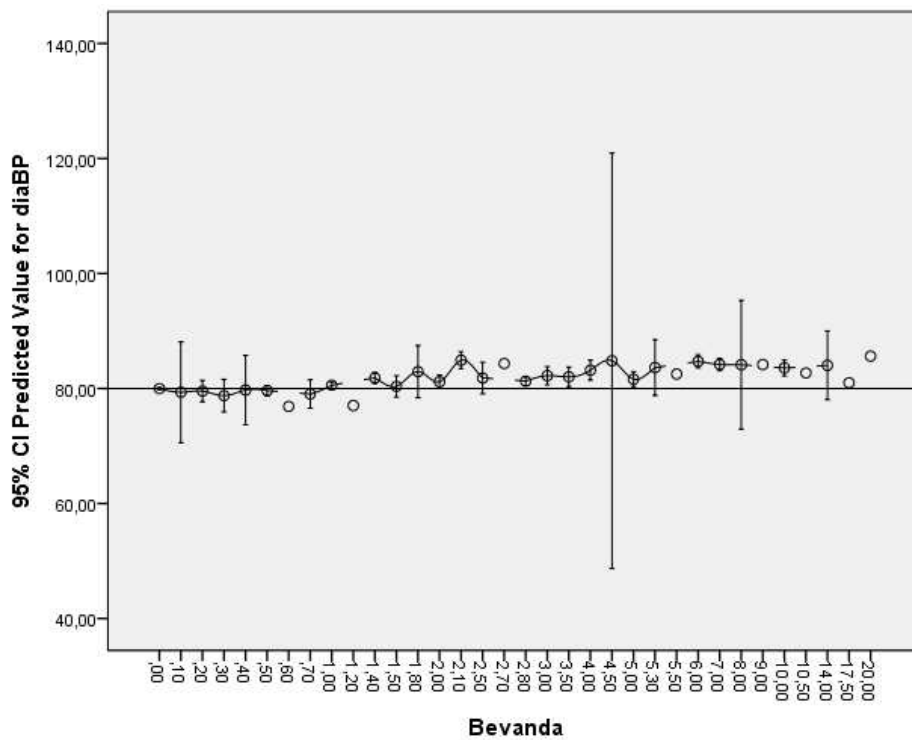
**Figure 12.** Fitting of the adjusted predicted values of diastolic blood pressure for the effects of white wine



**Figure 13.** Fitting of the adjusted predicted values of diastolic blood pressure for the effects of hard liquor



**Figure 14.** Fitting of the adjusted predicted values of diastolic blood pressure for the effects of red wine



**Figure 15.** Fitting of the adjusted predicted values of diastolic blood pressure for the effects of bevanda

## **5. DISCUSSION**

The results of this study illustrate a very subtle dip in diastolic blood pressure (1.1-1.3 mmHg) occurring alongside moderate red wine and beverage ingestion. The strongest decline in diastolic blood pressure was observed at a daily consumption of 1dL of red wine on a daily basis. This finding was lower than anticipated, since previous studies have suggested a daily intake of approximately 1-2 drinks (4,6,7) corresponding to 1.5-3dl would result in maximum effect. The depicted biphasic curve may likely demonstrate a hormetic effect. However, since the drop in blood pressure was only noted in adherence with red wine and not with enjoyment of other beverages, it is not likely to stem from alcohol per se. It would be more plausible to attribute the observed effect to ingredients unique to red wine, such as large amounts of polyphenols and flavonoids (2,6,11,16).

Interestingly, effects on the remaining four analyzed cardiovascular parameters (heart rate, systolic blood pressure, central diastolic and central systolic blood pressure) were not detectable. This is interesting, especially since we have not replicated the result of diastolic pressure in central diastolic pressure. This is possibly a methodological limitation, but in case that this is indeed a true finding, it may suggest that hormetic effects might have a greater peripheral mode of action, as opposed to the direct benefits on the heart muscle. Other studies in regards to mild alcohol ingestion have shown improvement of both vasculature and myocardium (3,6).

Furthermore these results demonstrated an interesting pattern of alcohol indulgence in Croatia. Beer and hard liquor were enjoyed in lower age groups. Both red and white wine were more commonly consumed by the elderly. We also detected interesting gender-based differences: women were almost completely avoiding beer with progressive age, while for the remaining alcohol types women reported low rates of ingestion across entire age spectrum. Men reported higher rates of alcohol consumption, without clear patterns of alcohol preference. The most interesting is the patchy appearance of hard liquor, in contrast to steadier rates of other alcohol types.

Limitations of this study include the cross-sectional nature of the data, which prevented the individual hormetic effect detection. An ideal study would include repeated measurements on the same individual in alcohol-abstinence vs. drinking period. Ideally a cross-over design would be implemented. However, such designs are very difficult to execute properly, especially in the negative phase, where subjects are expected not to consume any alcohol. On the other hand, it would be ethically questionable to invite non-drinkers to initiate drinking, further reducing the validity of the study.

A second major limitation to the study is social acceptability bias, in which subjects



could have misreported their true alcohol consumption. This is a common methodological problem, with limited means of control. Studies focused on determining the reliability of self-reported drinking looked into the credibility of the reports (reliability), the consistency of the reported pattern (stability) (25), desire to produce a socially acceptable response and a subjects ability to recall how much he drank (26). Drinking behaviour with high reliability can vary strongly over time and hence demonstrate low stability (25). Multiple studies had concluded that people were quite honest about their alcohol intake, however it often varied strongly over time. The limiting factor in these studies was an unstable drinking pattern (25,26). The greatest accuracy in recalling the amount of beverage consumed over time was determined to be 30 days (26). Overall questions related to self-reported drinking behaviour showed good to excellent agreement with the true amount of ethanol consumed (25,27). However, one unique study performed on the island Svalbard in Norway, where alcohol intake was able to be completely tracked, as the sole source of alcohol intake was via ferry, concluded self-reported alcohol intake to be 40% of the actual amount consumed (28).

In conclusion, it seems that despite numerous methodological limitation, the cross-sectional study was able to detect a minimal hormetic effect. However, the observed hormetic effect was very discrete. Other variables indicating a healthy lifestyle might have contributed to hormesis and should be looked into (5,6,13,14,17,19). These variables would include a favourable diet, physical exercise and other health-directed behaviours. Disentangling the magnitude and dynamics of such effects is methodologically tedious, but their understanding could be the base for future public health interventions. Public health intervention could ultimately achieve the goal of reducing the burden of chronic non-communicable diseases.

## **6. CONCLUSION**

1. A mild decrease in diastolic blood pressure could be observed with moderate daily red wine and bevanda consumption, but not with other alcoholic beverages.
2. Other cardiovascular parameters were not affected by ethanol ingestion.
3. The observed effect may well be due to hormetic effects of ethanol but may possibly be the result of red wine ingredients as flavonoids or polyphenols.
4. The daily consumption of red wine or bevanda in order to achieve a decrease in diastolic blood pressure was estimated to be around 1dL.
5. Further studies are warranted in order to determine whether the observed phenomenon is a result of ethanol hormesis.

## **7. REFERENCES**

1. Calabrese E, Baldwin L. Ethanol and hormesis. *Critical Reviews in Toxicology*. 2003;33:407-24.
2. Le Dare B, Lagente V, Gicquel T. Ethanol and its metabolites: update on toxicity, benefits, and focus on immunomodulatory effects. *Drug Metabolism Reviews*. 2019;10:1-17.
3. Gardner J, Mouton A. Alcohol effects on cardiac function. *Compr Physiol*. 2015;5:791-802.
4. Al-Rubaiee M, Cousins V, Haddad G, Jeffress M, Taghipour D, Umoh N, Walker R. The good, the bad, and the ugly with alcohol use and abuse on the heart. *Alcohol Clin Exp Res*. 2013;37:1253-60.
5. Hayes D. Nutritional hormesis. *Eur J Clin Nutr*. 2007;61:147-59.
6. Collins A, Neafsey E, Mukamal K, Gray M, Parks D, Das D, Korthuis R. Alcohol in moderation, cardioprotective and neuroprotection: epidemiological considerations and mechanistic studies. *Alcohol Clin Exp Res*. 2009;33:206-19.
7. Barr T, Helms C, Grant K, Messaoudi I. Opposing effects of alcohol on the immune system. *Prog Neuropsychopharmacol Biol Psychiatry*. 2016;65:242-51.
8. Thayer A, Melnick R, Burns K, Davis D, Huff J. Fundamental flaws of hormesis for public health decision. *Environ Health Perspect*. 2005;113:1271-76.
9. Schmidt-Heck W, Wönne E, Hiller T, Menzel U, Koczan D, Damm G et al. Global transcriptional response of human liver cells to ethanol stress of different strength reveals hormetic behavior. *Alcoholism: Clinical and Experimental Research*. 2007;41:883–894.
10. Prickett C, Lister E, Collins M, Trevithick-Sutton C, Hirst M, Vinson J et al. Alcohol: Friend or foe? Alcoholic beverage hormesis in atherosclerosis and cataract is related to plasma antioxidant activity. *Nonlinearity Biol Toxicol Med*. 2004;2:353-70.
11. Diaz L, Gomez-Martinez S, Marcos A, Nova E, Romeo J, Wärnberg J. Moderate alcohol consumption and the immune system: A review. *British Journal of Nutrition*. 2007;98:111-15.
12. Lindsay D. Nutrition, hormetic stress and health. *Nutr Res Rev*. 2005;18:249-58.
13. Israel Y, Rivera-Meza M, Quintanilla M, Sapag A, Tampier L. Acetaldehyde burst protection of ADH1B\*2 against alcoholism: An additional hormesis protection against esophageal cancers following alcohol consumption?. *Alcohol Clin Exp Res*. 2011;35:806-10.
14. Calabrese E, Baldwin L. U-shaped dose-responses in biology, toxicology, and public health. *Annual Review of Public Health*. 2001;22:15-33.
15. Shrader-Frechette K. Ideological toxicology: invalid logic, science, ethics about low-dose pollution. *Human & Experimental Toxicology*. 2008;647-57.
16. Plauth A, Geikowski A, Cichon A, Wowro S, Liedgens L, Rousseau M et al. Hormetic shifting of redox environment by pro-oxidative resveratrol protects cells against stress. *Data of*

- oxygen-and pH-dependent oxidation of resveratrol. 2016;9:433-37.
17. Crespo M, Tome-Carneiro J, Burgos-Ramos E, Kohen V, Espinosa M, Herranz J, et al. One-week administration of hydroxytyrosol to humans does not activate phase II enzymes. *Pharmacological Research*. Volumes 95-96; 2015. p. 132-37.
  18. Calabrese E. Hormesis principles and applications. *Homeopathy*. 2015;104:69-82.
  19. Qiang Ma. Role of Nrf2 in oxidative stress and toxicity. *Annu Rev Pharmacol Toxicol*. 2013;53:401-26.
  20. phytochemicals.info [Internet]. Zoersel: Top Cultures, Inc.; c8859-01 [updated 2020 Jul 9; cited 2020 Jul 9]. Available from: <http://www.phytochemicals.info/>.
  21. Anzenbacher P, Anzenbacherova E, Jancova P. Phase II drug metabolizing enzymes. *Biomed Pap Med Fac Univ Palacky Olomouc Czech Repub*. 2010;154:103-16.
  22. Sonneborn J, Emeritus. Hormetic triggers for intervention in aging, disease and trauma. *American Journal for Pharmacology and Toxicology*. 2008;3:4-13.
  23. Kesäniemi Y, Kuusi T, Nikkilä E, Sane T, Taskinen M, Välimäki M, Ylikahri R. Alcohol-induced changes in serum lipoproteins and in their metabolism. *American Heart Journal*. 1987;113:458-64.
  24. Adams C, Choi D, Nam H.W, Knight E, Ruby C. An essential role for adenosine signaling in alcohol abuse. *Curr Drug Abuse Rev*. 2010;3:163-74.
  25. Grunewald P, Johnson F. The stability and reliability of self-reported drinking measures. *Journal of Studies on Alcohol*. 2006;67:738-45.
  26. Embree B, Whitehead P. Validity and reliability of self-reported drinking behaviour: dealing with the problem of response bias. *Journal of Studies on Alcohol*. 1993;54:334-44.
  27. Dal Grande E, Fullerton S, Taylor A. Reliability of self-reported health risk factors and chronic conditions questions collected using the telephone in south Australia, Australia. *BMC Med Res Methodol*. 2012;26:12-108.
  28. Hoyer G, Nilssen O, Brenn T, Schirmer H. The Svalbard study 1988-89: a unique setting for validation of self-reported alcohol consumption. *Addiction*. 1995;90:539-44.

## **8. SUMMARY**

**Objectives:** The aim of the study was to conclude possible hormetic benefits of alcohol on the cardiovascular system.

**Materials and methods:** This thesis is based on a cross-sectional study from data collected from the 10,001 Dalmatians study. The final sample size for this analysis was 4,850 subjects. The samples consist of three sub-groups, two island groups and one mainland. Alcoholic beverages included white wine, beer, hard liquor, red wine and bevanda (mixture red wine and water). The cardiovascular data block served as the cornerstone for analyses. Analyzed variables included: a) peripheral systolic blood pressure, b) peripheral diastolic blood pressure, c) central systolic blood pressure, d) central diastolic blood pressure, and e) heart rate.

**Results:** A slight decrease in diastolic pressure could be detected with daily consumption of red wine or bevanda at 1dl. Other cardiovascular parameters were not affected and other alcoholic beverages showed no effects.

**Conclusion:** The observed decrease in diastolic blood pressure may well be due to hormetic effects of ethanol, but possibly other red wine ingredients as flavonoids or polyphenols may be responsible. Further studies are warranted in order to determine whether the observed phenomenon is a result of ethanol hormesis. A cross-over design would be the ideal study in order to determine alcohol hormesis, however this study would be very difficult to execute.



## **9. SUMMARY IN CROATIAN**

**Naslov:** HORMETIČKI UČINCI UMJERENOG PIJENJA VINA: DOKAZI IZ POPREČNO-PRESJEČNE STUDIJE

**Ciljevi:** Istražiti mogući hormetički učinak pijenja alkoholnih pića na srčano-žilni sustav.

**Materijali i metode:** Ovaj rad temelji se na podacima iz presječnog istraživanja, prikupljenima u projektu 10.001 Dalmatinac. Uzorak za ovo istraživanje sastojao se od 4,850 ispitanika, od kojih su dvije skupine bile s otoka, a treća istraživana skupina s kopna. Alkoholna pića za koja su prikupljeni podatci bila su bijelo i crveno vino, bevanda, pivo i žestoka pića. Mjereno je pet srčano-žilnih varijabli, periferni sistolički i dijastolički tlak, središnji sistolički i dijastolički tlak te srčana frekvencija.

**Rezultati:** Zabilježeno je malo ali statistički značajno smanjenje dijastoličkog krvnog tlaka pri dnevnom konzumaciji crvenog vina i bevande, koje odgovara količini od 1 dL. Ostali pokazatelji srčano-žilnog sustava nisu bili povezani s umjerenim pijenjem alkoholnih pića.

**Zaključci:** Učinak koji je utvrđen je mogući hormetički učinak alkohola, ali možda i drugih sastavnica crvenog vina poput flavonoida i polifenola, za što su potrebna dodatna istraživanja. Pri tome bi idealan oblik istraživanja bio ukriženo, koje je metodološki zahtjevno.

## **10. CURRICULUM VITAE**

**Personal Data**

Name: Marina Lukežić

Date of birth: October 24<sup>th</sup> 1994

Citizenship: US and Croatian

Address: Škrape 3, 21000 Split

E-mail: [mlukezic@outlook.de](mailto:mlukezic@outlook.de)

**Education:**

2014 - 2020: University of Split School of Medicine, Croatia

2006 - 2014: Dr. Johanna-Decker Gymnasium, Amberg, Germany

**Extracurricular:**

I was able to manage my study alongside pilates and outdoor activities as jogging, swimming, biking.